

SLIDING WINDOW

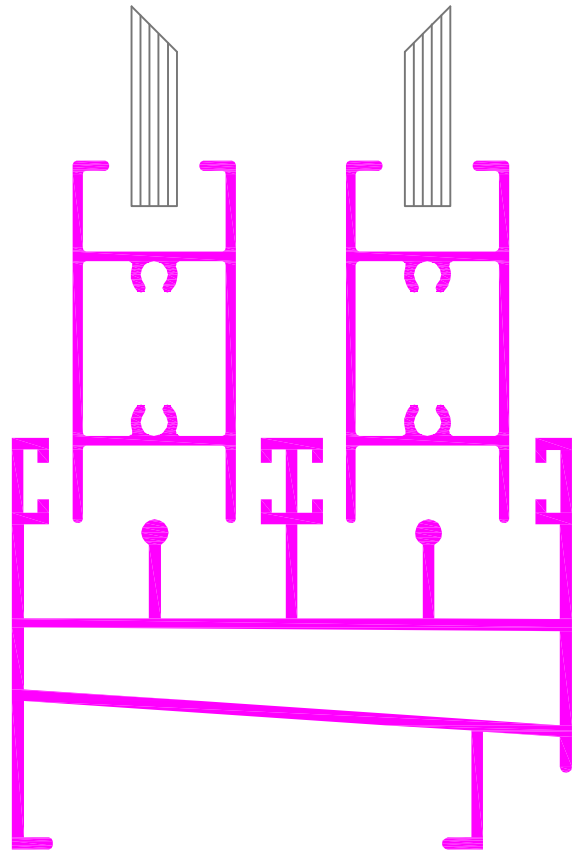

SLIDING WINDOW

(S/W 1/2")
(SERIES -15 mm.)

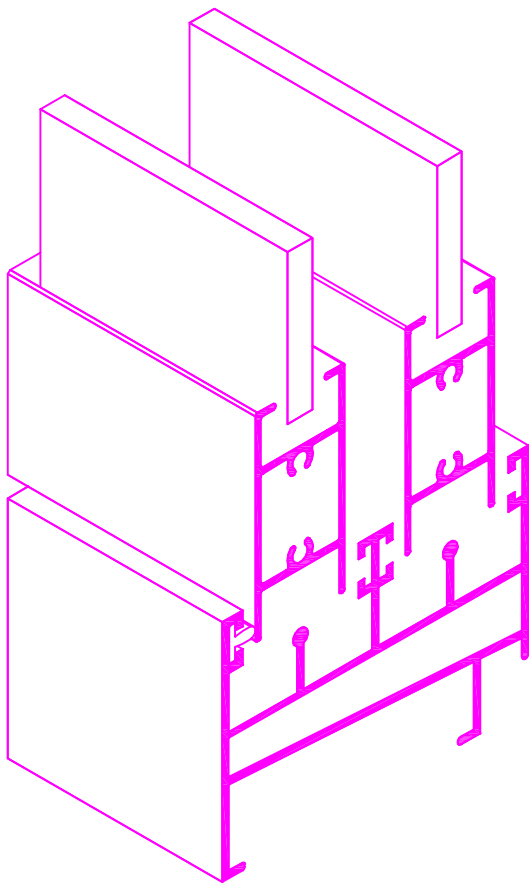
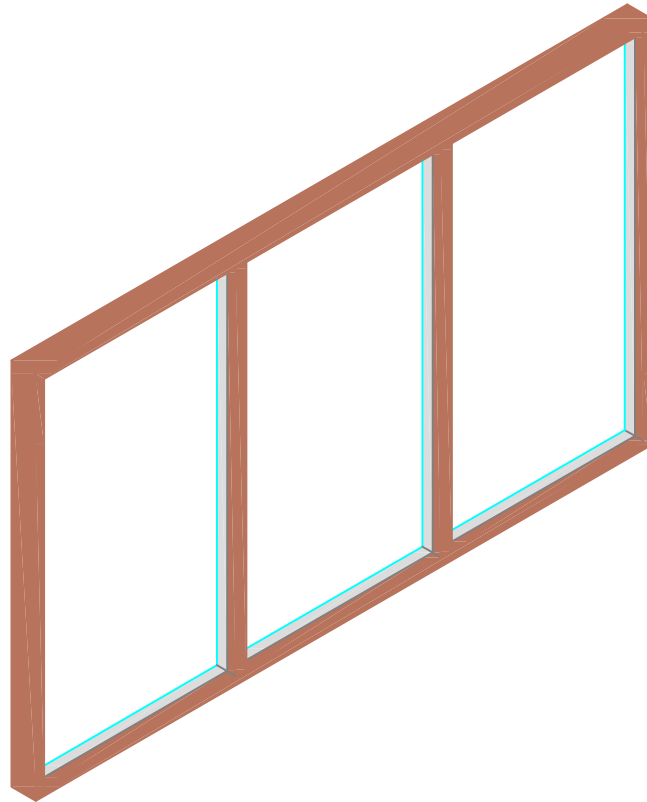
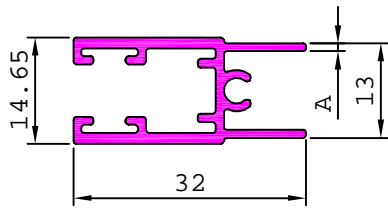

SL. No.	Section No.	A	Weight kg/m
1	20969	0.80	0.233
2	20581	1.10	0.344

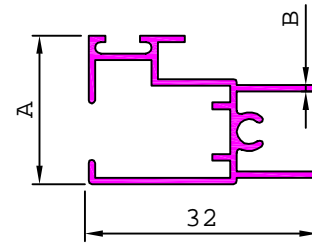

SL. No.	Section No.	A	B	Weight kg/m
1	20868	20.50	0.70	0.220
2	20947	20.75	0.82	0.257
3	20584	20.75	1.10	0.335

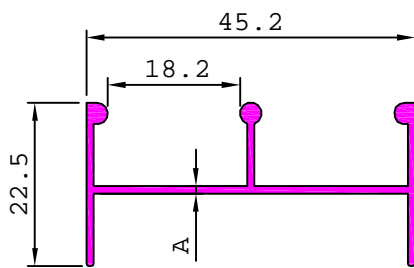

SL. No.	Section No.	A	Weight kg/m
1	20624	1.20	0.353
2	20961	1.00	0.304

20946

0.238 kg/m

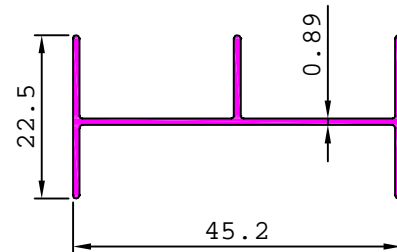

20951

0.297 kg/m

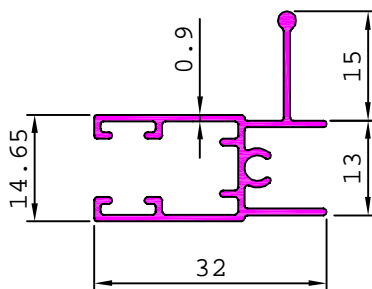

SLIDING WINDOW

(S/W 5/8")
(SERIES -15 mm.)

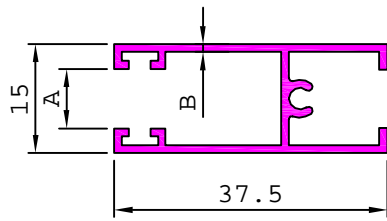

SL. No.	Section No.	A	B	Weight kg/m
1	20809	8.20	1.08	0.329
2	20597	7.80	1.60	0.485

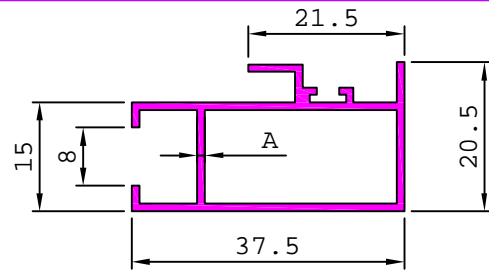

SL. No.	Section No.	A	Weight kg/m
1	20810	1.07	0.369
2	20655	1.50	0.487

20671 0.699 kg/m

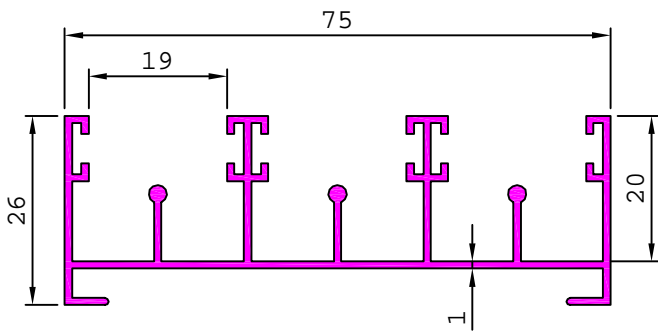

20672 0.594 kg/m

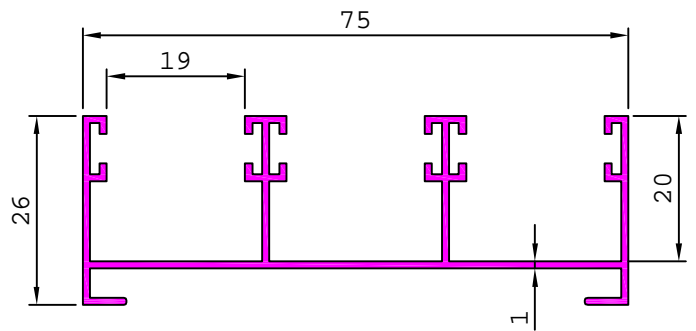

20690 0.366 kg/m

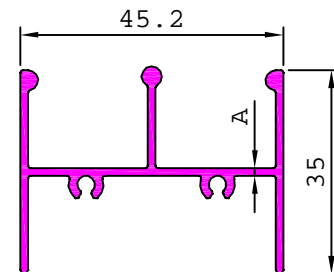
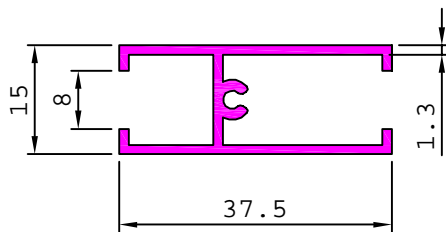

SL. No.	Section No.	A	Weight kg/m
1	20808	0.98	0.414
2	20664	1.30	0.562

20668 0.377 kg/m

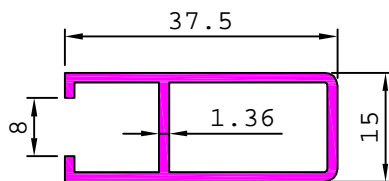

20689 0.481 kg/m

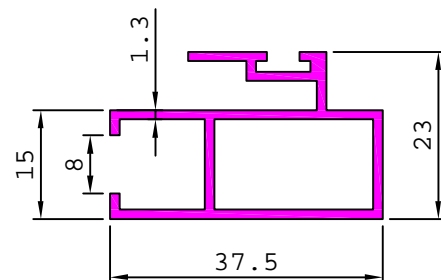

SLIDING WINDOW

(S/W 5/8")
(SERIES -15 mm.)

20669

0.548 kg/m

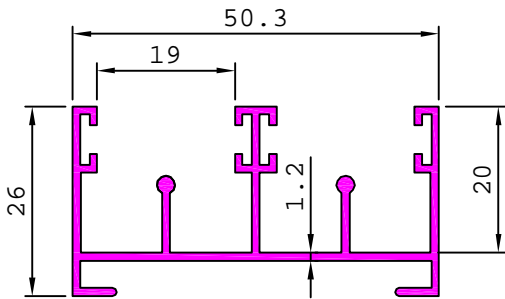

20670

0.432 kg/m

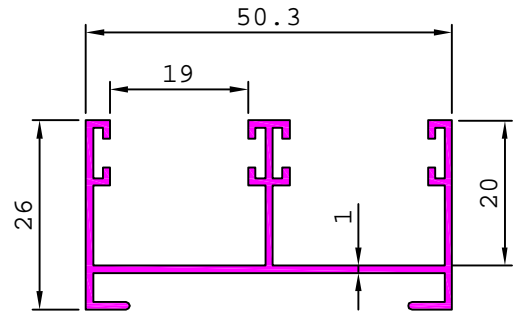

20735

0.793 kg/m

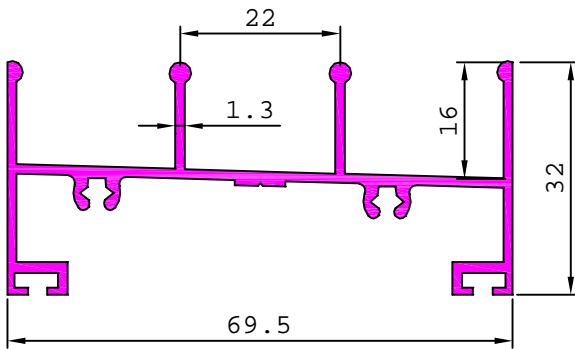

20886

0.411 kg/m

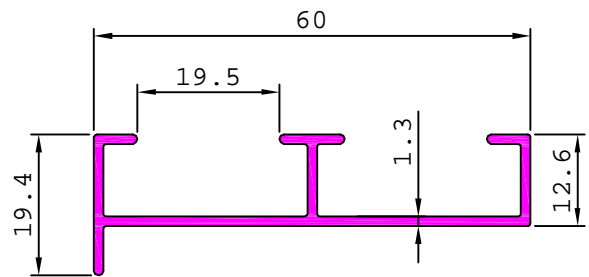

SHUTTER SECTION SLIDING WINDOW (SERIES -18 mm.)

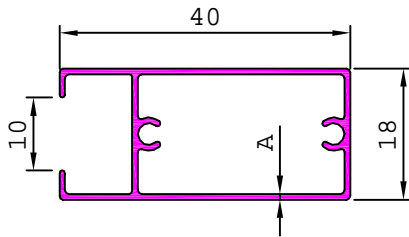

SL. No.	Section No.	A	Weight kg/m
1	20547	0.79	0.289
2	20807	0.91	0.325
3	20606	1.09	0.390
4	21455	1.19	0.418
5	20846	1.29	0.456
6	21449	1.42	0.494
7	20738	1.55	0.547
8	21515	2.00	0.696

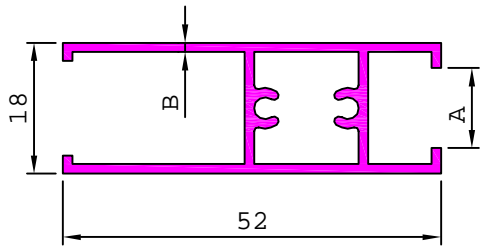

SL. No.	Section No.	A	B	Weight kg/m
1	20811	11.00	0.91	0.390
2	20963	11.00	1.13	0.488
3	20847	10.00	1.29	0.547
4	20652	11.00	1.30	0.547
4	20750	10.00	1.56	0.651

21545

0.677 kg/m

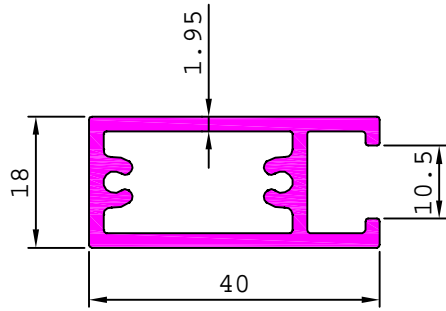

20577

0.522 kg/m

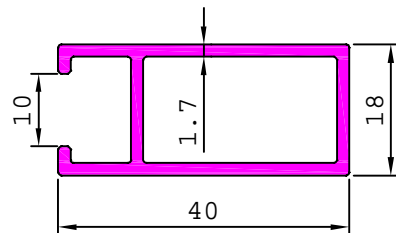

SHUTTER SECTION SLIDING WINDOW (SERIES -18 mm.)

20893

0.434 kg/m

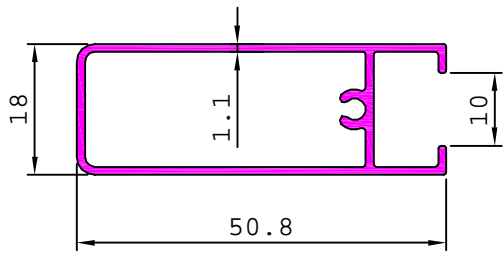

20925

0.549 kg/m

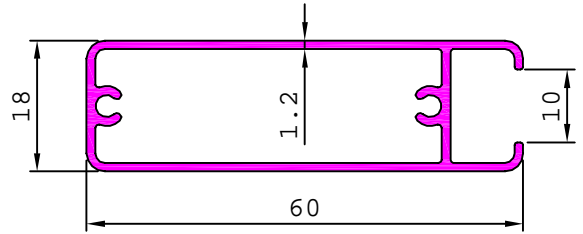

21430

0.307 kg/m

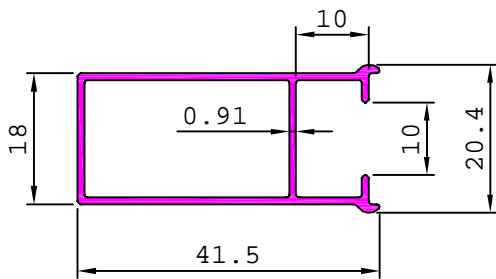

S6415

0.695 kg/m

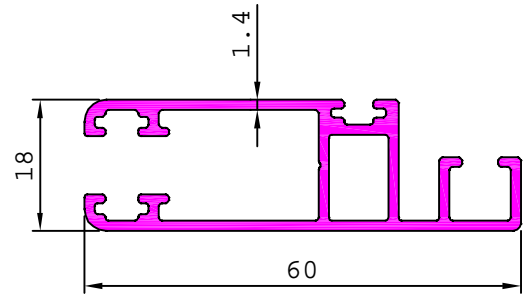

20802

0.520 kg/m

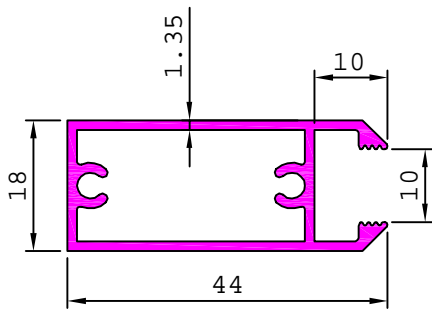

20887

0.548 kg/m

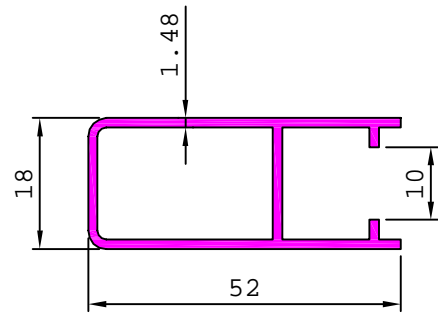

G101484

0.608 kg/m

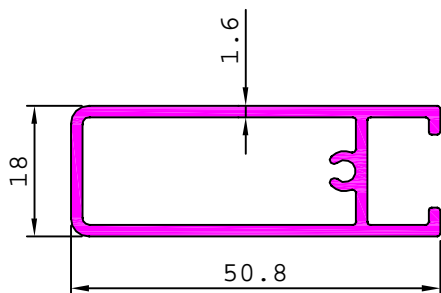

SHUTTER SECTION SLIDING WINDOW (SERIES -18 mm.)

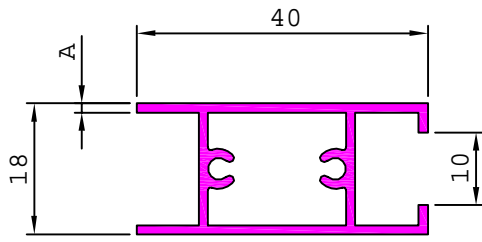

SL. No.	Section No.	A	Weight kg/m
1	20545	0.79	0.288
2	20805	0.91	0.325
3	20604	1.09	0.390
4	21585	1.19	0.418
5	20844	1.29	0.456
6	21448	1.42	0.494
7	20736	1.55	0.547
8	21513	2.00	0.695

21575

0.677 kg/m

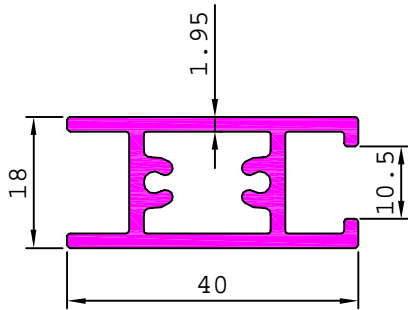

20803

0.598 kg/m

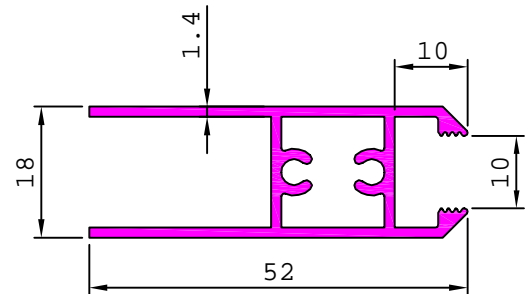

20567

0.601 kg/m

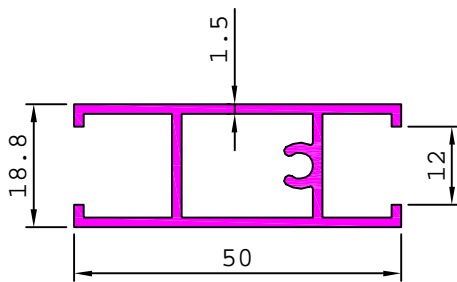

20920

0.503 kg/m

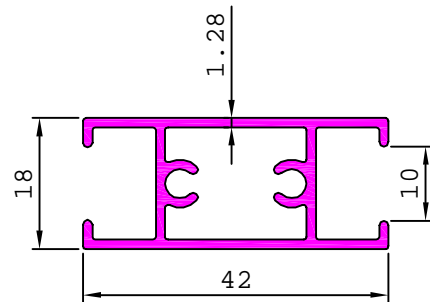

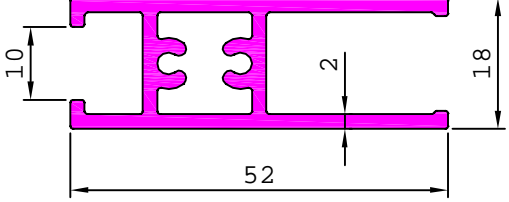
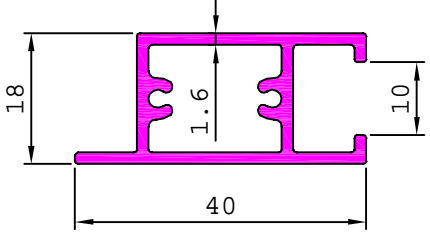
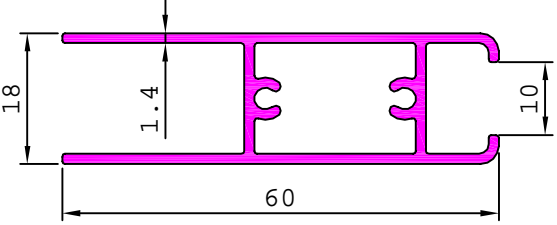
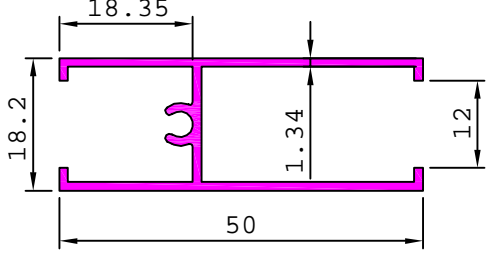
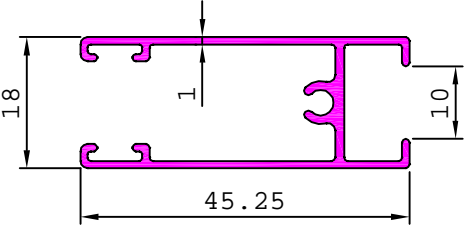
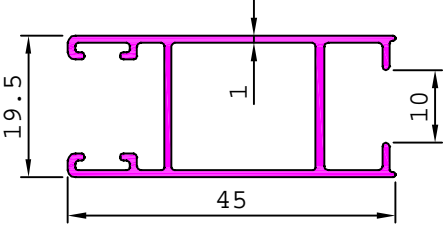
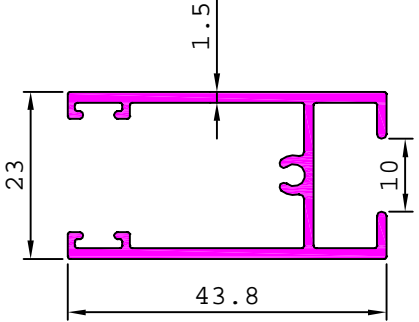
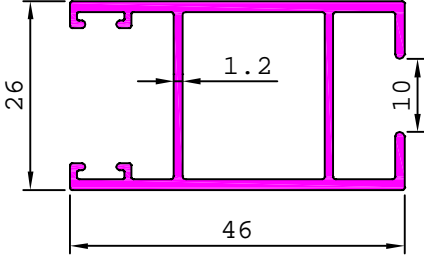
SHUTTER SECTION		SLIDING WINDOW		(SERIES -18 mm.)
21649	0.828 kg/m	S4535	0.519 kg/m	
				
20926	0.641 kg/m	20876	0.471 kg/m	
				
21898	0.383 kg/m	21899	0.403 kg/m	
				
MATCHING WITH 21902 & 21903		MATCHING WITH 21902 & 21903		
G100796	0.518 kg/m	G100797	0.602 kg/m	
				

INTERLOCK SECTION **SLIDING WINDOW** (SERIES -18 mm.)

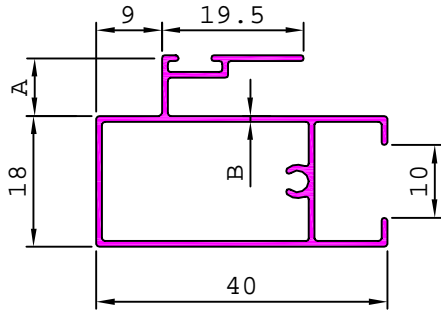

SL. No.	Section No.	A	B	Weight kg/m
1	20546	8.34	0.80	0.346
2	20806	9.00	0.89	0.380
3	20605	8.70	1.00	0.440
4	21454	9.00	1.19	0.507
5	20845	9.00	1.29	0.547
6	20737	9.00	1.45	0.607

20804 0.626 kg/m

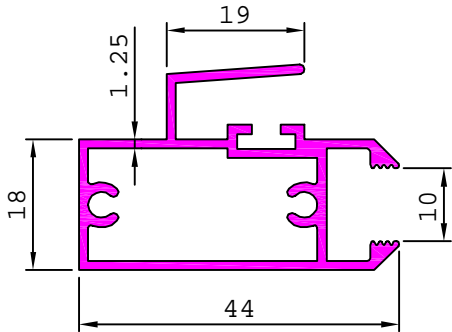

20576 0.663 kg/m

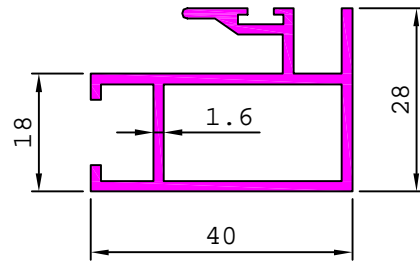

20892 0.527 kg/m

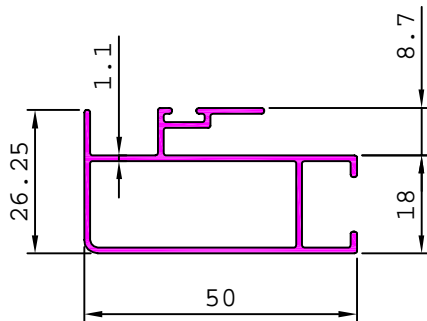

21494 0.426 kg/m

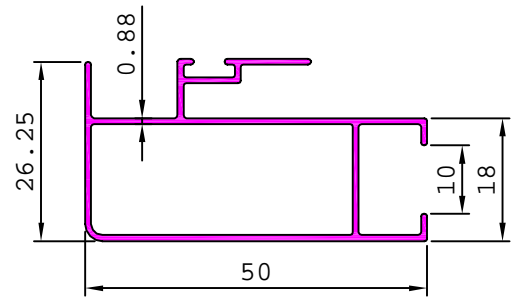

20924 0.683 kg/m

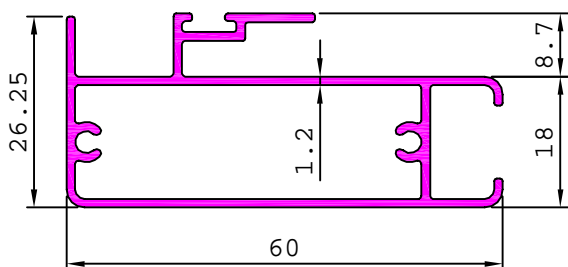

INTERLOCK SECTION **SLIDING WINDOW** (SERIES -18 mm.)

21302

0.457 kg/m

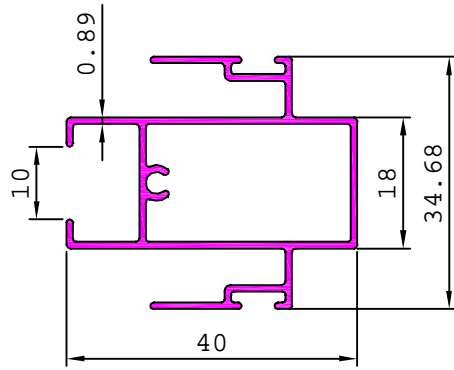

21900

0.392 kg/m

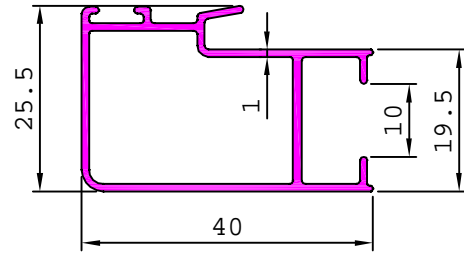

MATCHING SECTION WITH 21902 & 21903

21514

0.817 kg/m

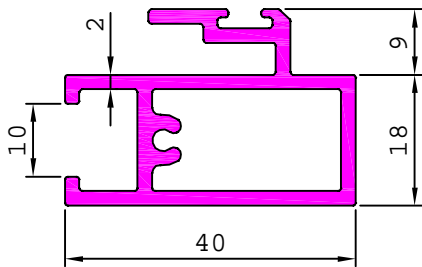

21552

0.798 kg/m

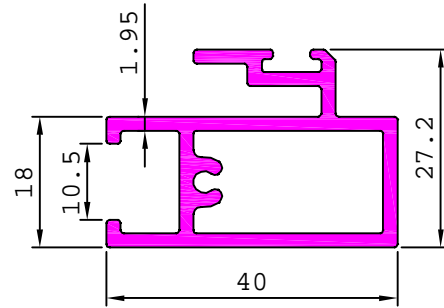

TRACK SECTION

SLIDING WINDOW

(SERIES -18 mm.)

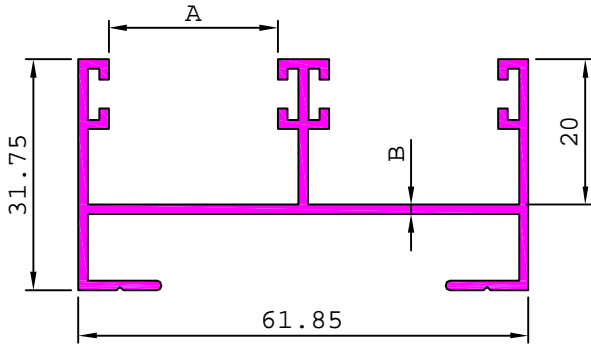

SL. No.	Section No.	A	B	Weight kg/m
1	20812	23.95	0.81	0.441
2	20966	23.85	1.00	0.543
3	20681	23.25	1.30	0.659
4	20829	22.70	1.50	0.784
5	21519	22.70	2.00	0.942

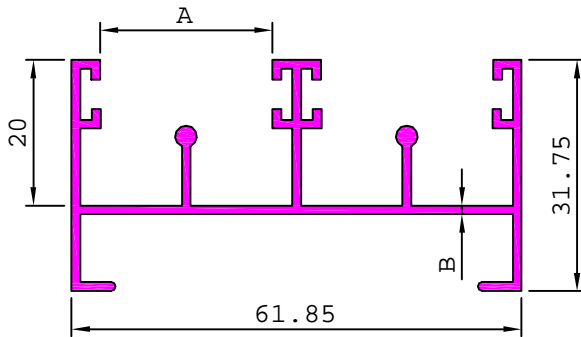

SL. No.	Section No.	A	B	Weight kg/m
1	20813	23.95	0.85	0.497
2	20956	23.85	1.05	0.613
3	20619	23.70	1.20	0.695
4	20830	22.70	1.50	0.909
5	21520	22.70	2.00	1.087

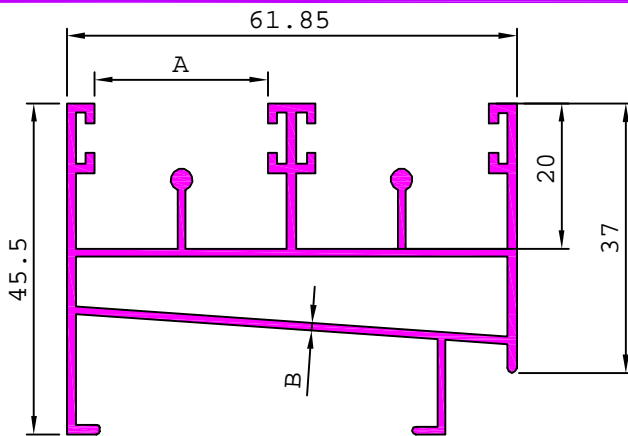

SL. No.	Section No.	A	B	Weight kg/m
1	20965	23.85	1.05	0.882
2	20657	23.45	1.30	1.055

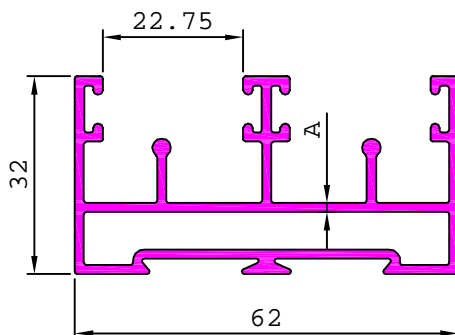

SL. No.	Section No.	A	Weight kg/m
1	21452	1.30	1.017
2	21051	1.47	1.106

TRACK SECTION

SLIDING WINDOW

(SERIES -18 mm.)

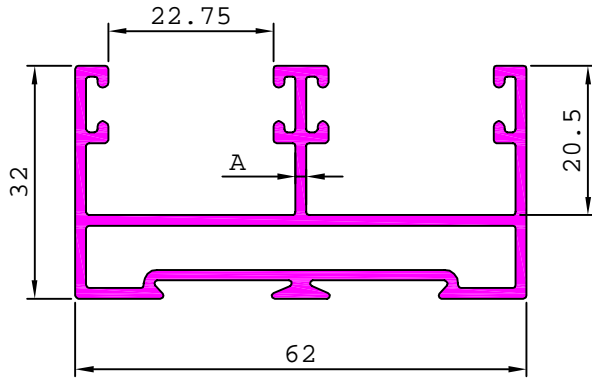

SL. No.	Section No.	A	Weight kg/m
1	21453	1.30	0.923
2	20888	1.47	1.005

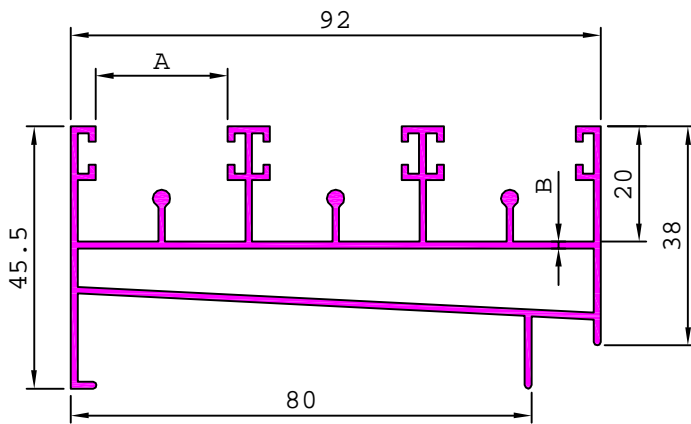

SL. No.	Section No.	A	B	Weight kg/m
1	20814	22.95	1.18	1.302
2	21031	22.95	1.30	1.441
3	20617	22.70	1.50	1.659
4	21518	22.70	2.00	2.040

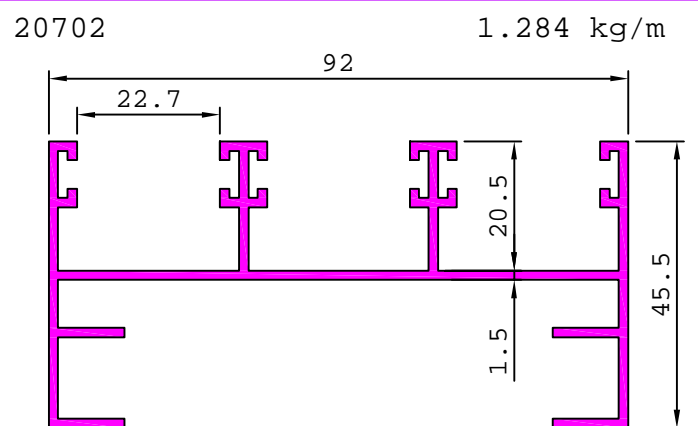
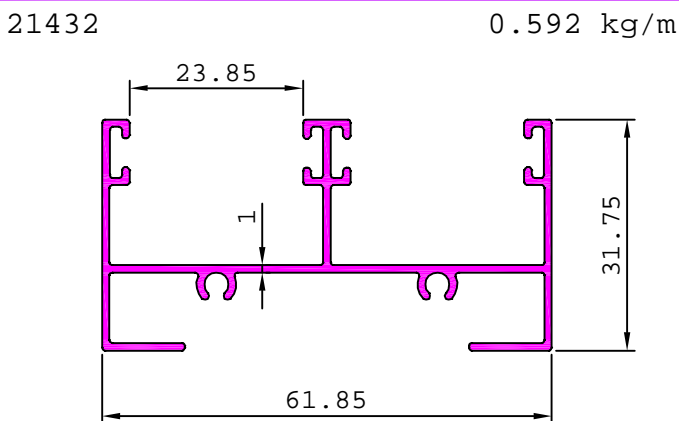
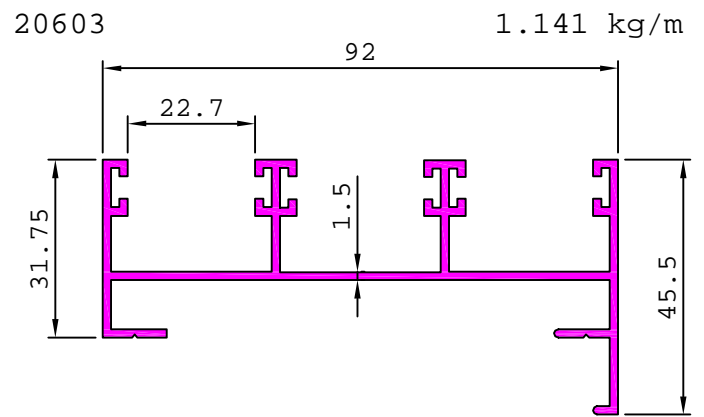
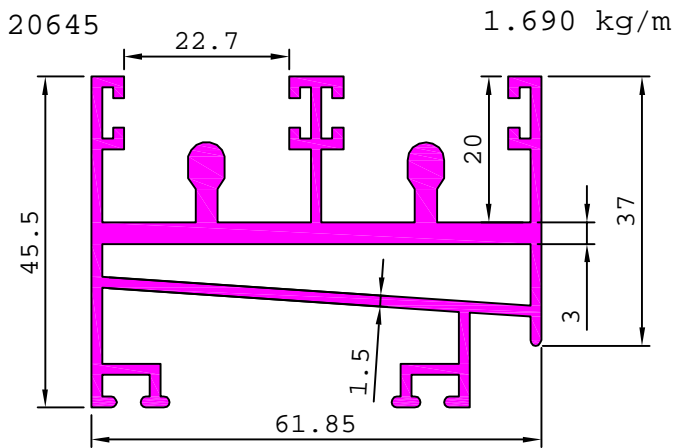

TRACK SECTION

SLIDING WINDOW

(SERIES -18 mm.)

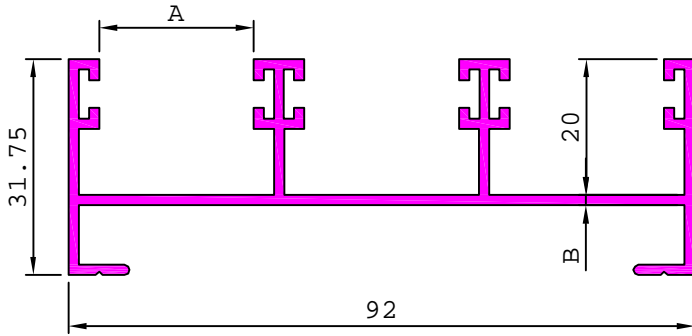

SL. No.	Section No.	A	B	Weight kg/m
1	20816	23.60	0.95	0.683
2	20958	23.60	1.05	0.759
3	21447	23.60	1.20	0.856
4	20621	23.30	1.30	0.929
5	20831	22.70	1.50	1.060
6	21517	22.70	2.00	1.273

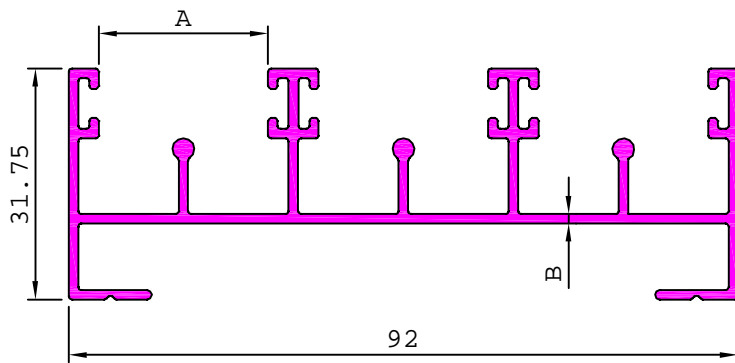

SL. No.	Section No.	A	B	Weight kg/m
1	20815	23.60	0.88	0.739
2	20957	23.60	1.10	0.911
3	21446	23.60	1.20	0.986
4	20620	23.30	1.30	1.065
5	20832	22.70	1.50	1.248
6	21516	22.70	2.00	1.490

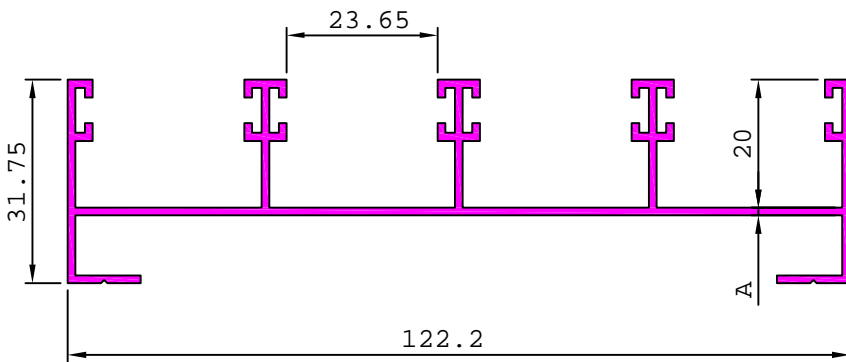

SL. No.	Section No.	A	Weight kg/m
1	20817	1.10	0.976
2	20666	1.20	1.093

21431 0.813 kg/m

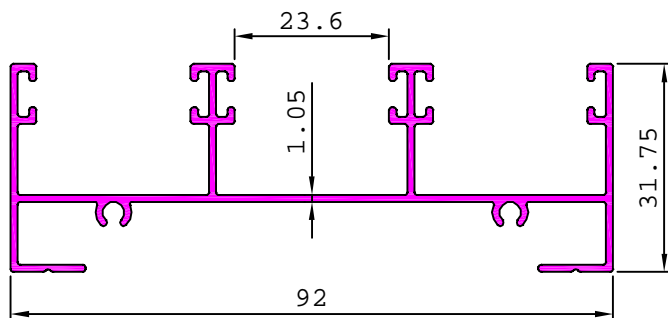

21645 1.033 kg/m

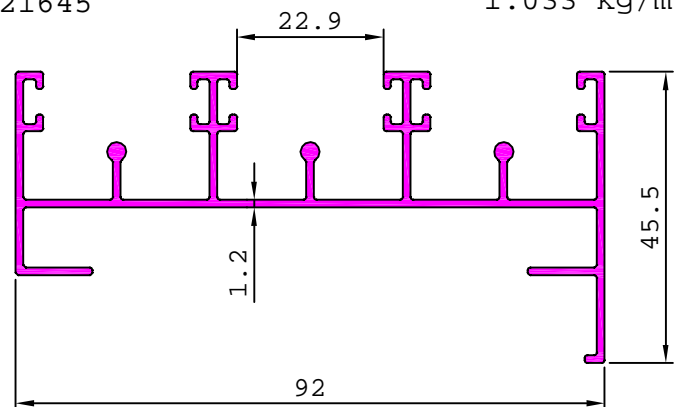

TRACK SECTION

SLIDING WINDOW

(SERIES -18 mm.)

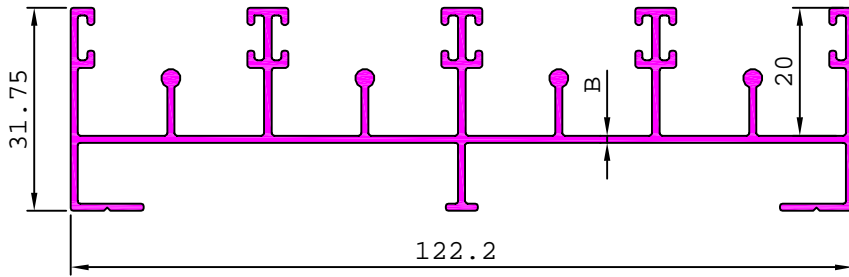

SL. No.	Section No.	A	B	Weight kg/m
1	20818	23.90	1.00	1.093
2	20706	23.90	1.10	1.205
3	20834	22.70	1.50	1.648
4	21521	22.70	2.00	1.964

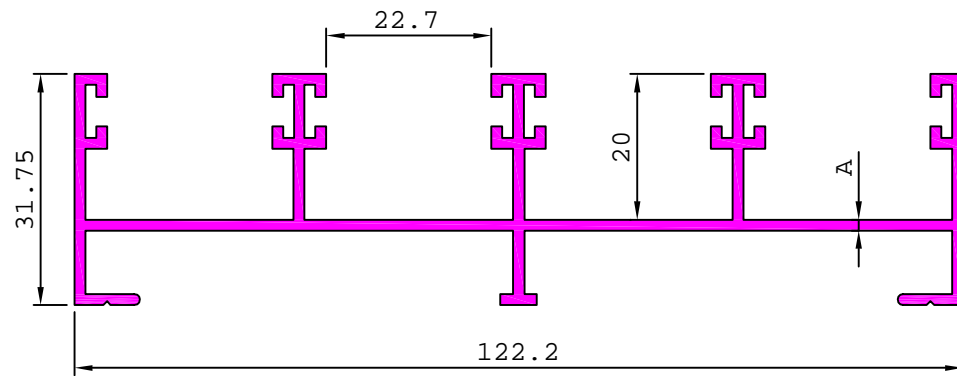

SL. No.	Section No.	A	Weight kg/m
1	20833	1.50	1.398
2	21522	2.00	1.674

20667

1.148 kg/m

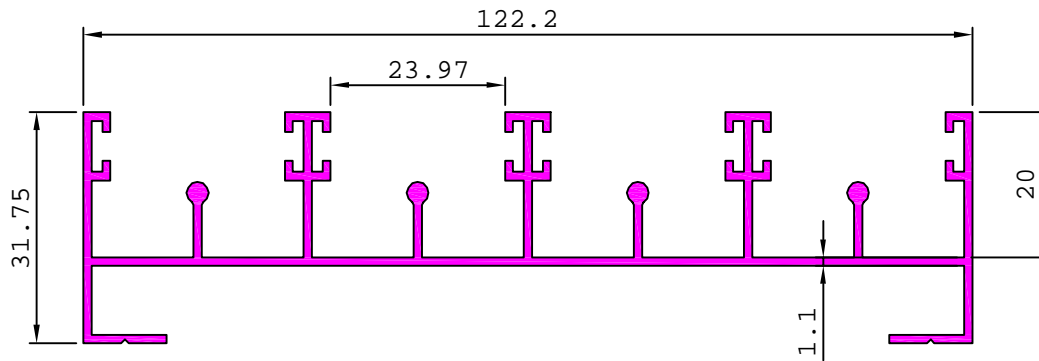

TRACK SECTION

SLIDING WINDOW

(SERIES -18 mm.)

20674

1.829 kg/m

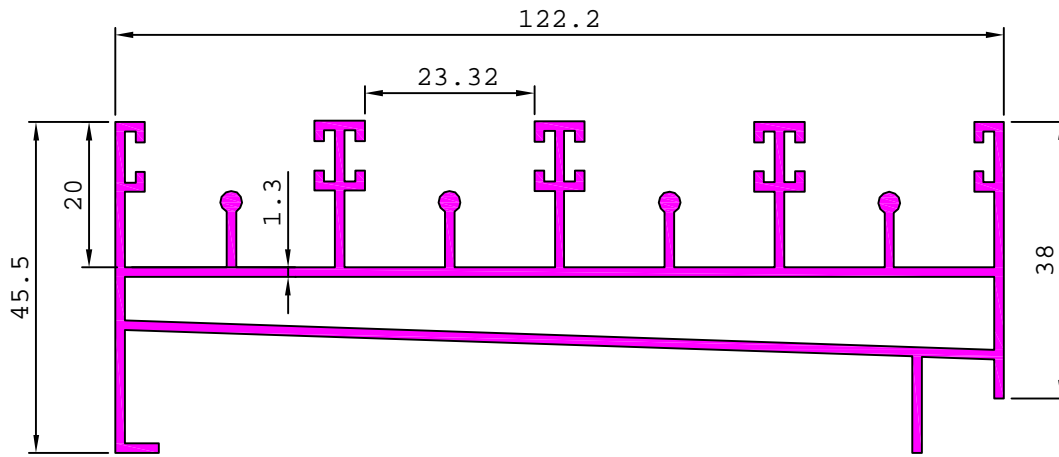

21028

1.792 kg/m

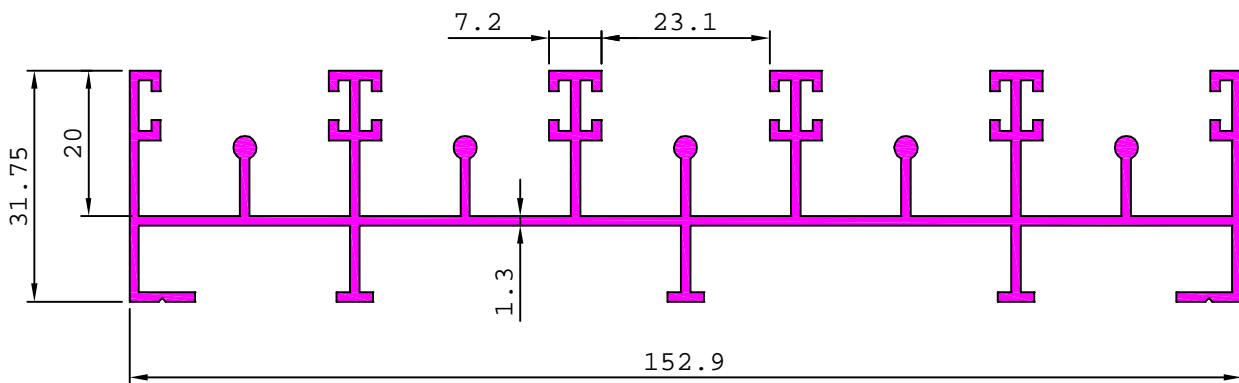

21029

1.523 kg/m

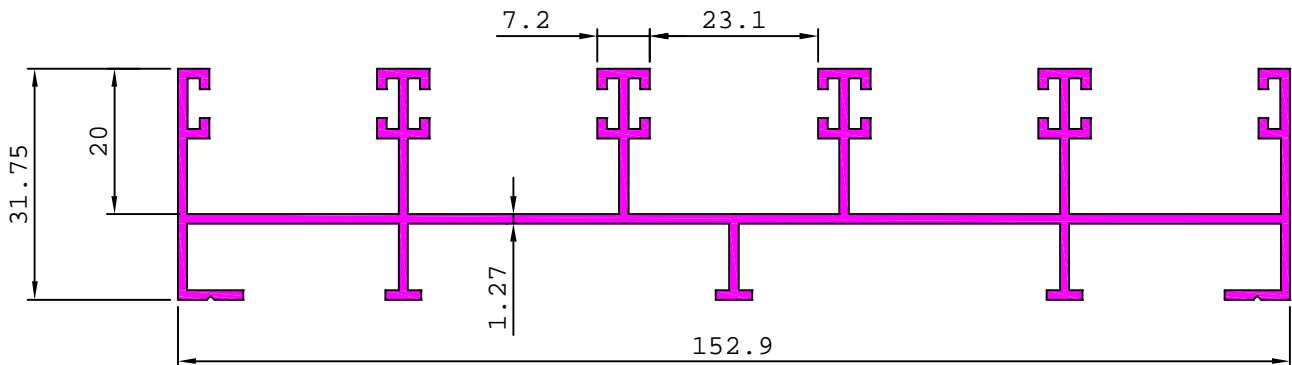

SHUTTER SECTION SLIDING WINDOW (SERIES -20 mm.)

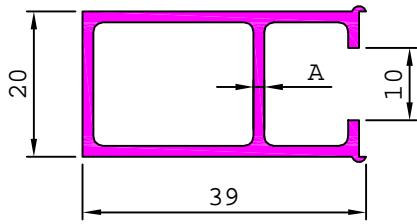

SL. No.	Section No.	A	Weight kg/m
1	20968	0.80	0.277
2	20931	1.00	0.342
3	20975	1.25	0.418
4	20709	1.50	0.488
5	21093	2.00	0.634

21357

0.571 kg/m

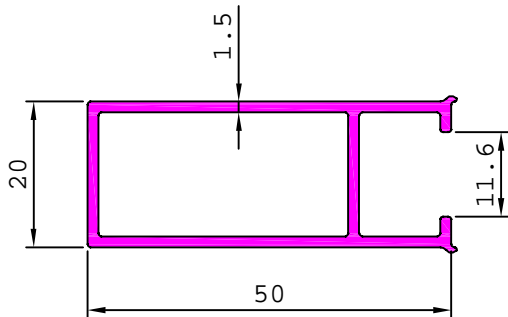

20530

0.571 kg/m

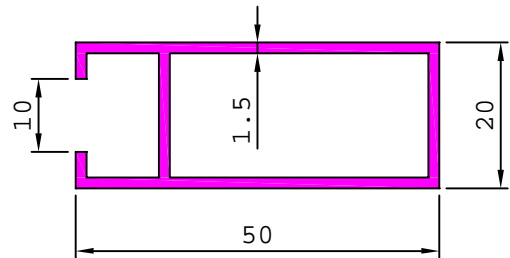

20544

0.495 kg/m

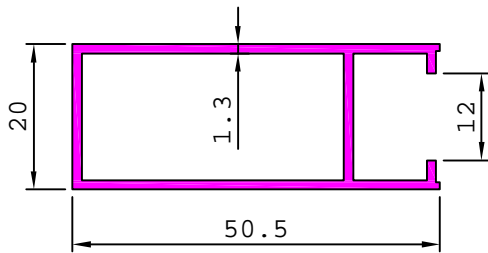

21616

0.242 kg/m

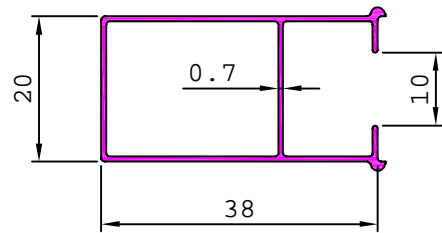

21283

0.512 kg/m

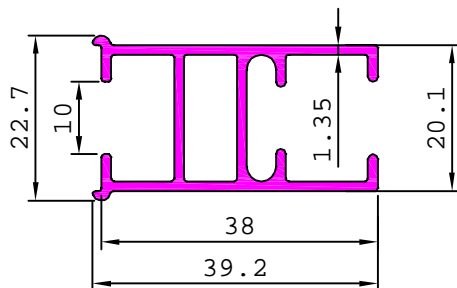

21320

0.477 kg/m

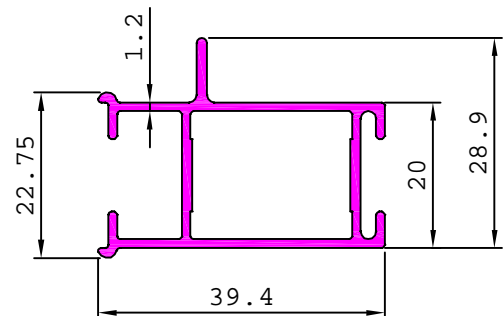

SHUTTER SECTION

SLIDING WINDOW

(SERIES -20 mm.)

20972

0.451 kg/m

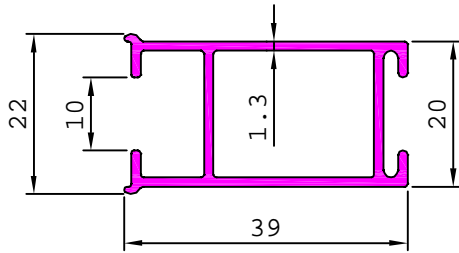

SHUTTER SECTION SLIDING WINDOW (SERIES -20 mm.)

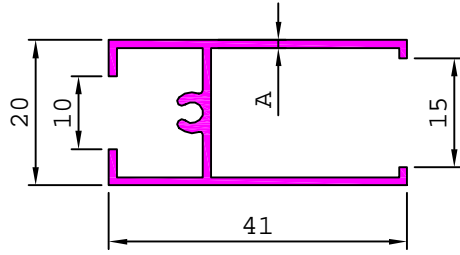

SL. No.	Section No.	A	Weight kg/m
1	20988	0.98	0.314
2	20710	1.10	0.355
3	21092	2.00	0.606

20529

0.642 kg/m

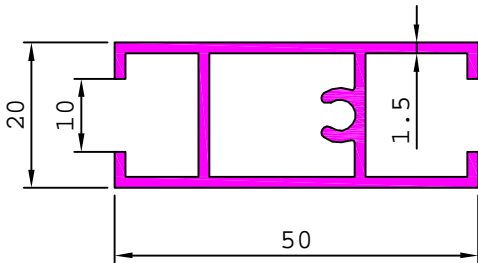

20551

0.484 kg/m

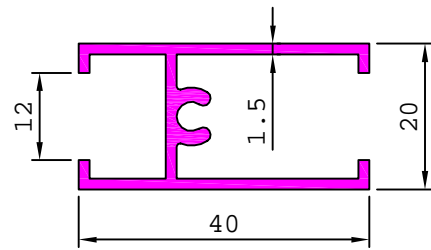

21850

0.470 kg/m

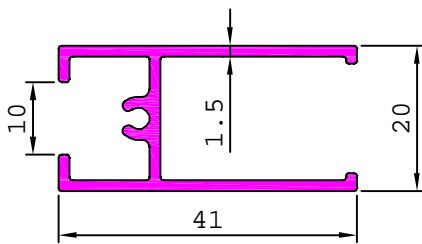

21022

0.539 kg/m

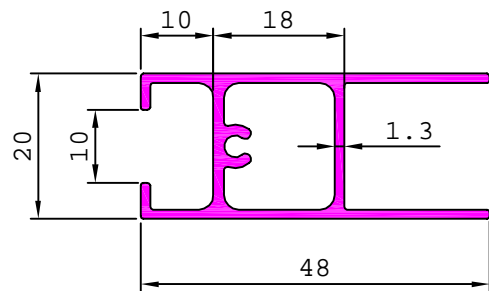

INTERLOCK SECTION

SLIDING WINDOW

(SERIES -20 mm.)

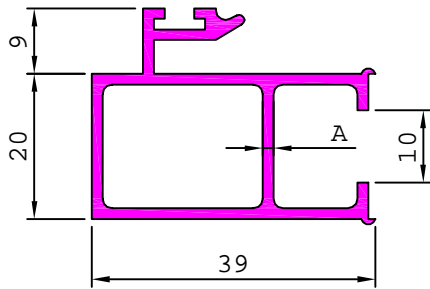

Sl. No.	Section No.	A	Weight kg/m
1	21052	1.00	0.409
2	20976	1.15	0.473
3	20708	1.50	0.605
4	21094	2.00	0.734

21849

0.344 kg/m

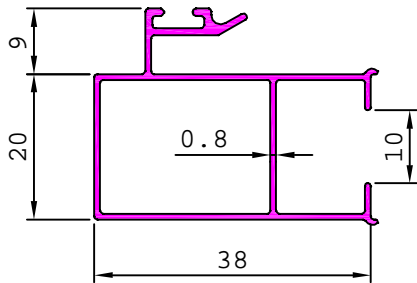

21611

0.435 kg/m

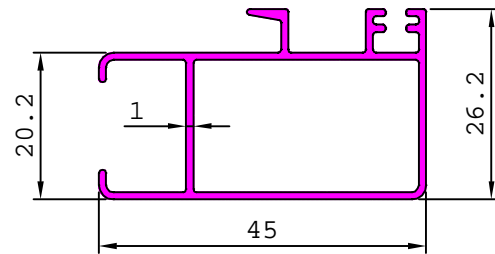

20566

0.693 kg/m

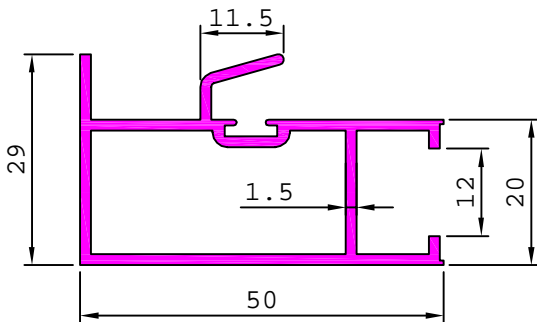

20531

0.697 kg/m

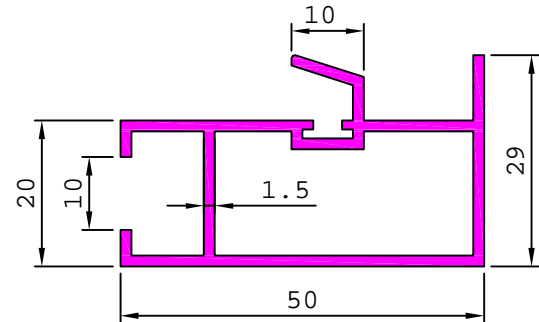

21356

0.678 kg/m

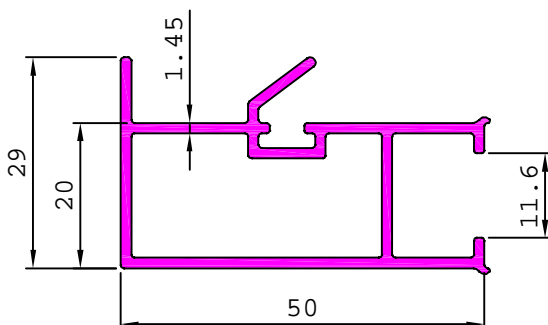

20840

0.594 kg/m

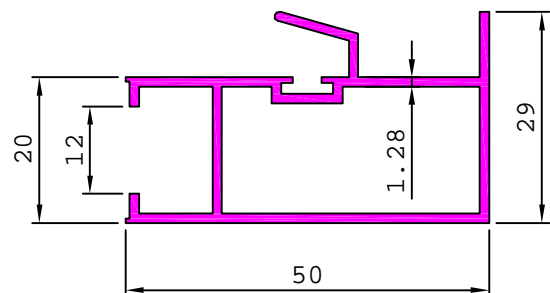

INTERLOCK SECTION

SLIDING WINDOW

(SERIES -20 mm.)

20973

0.503 kg/m

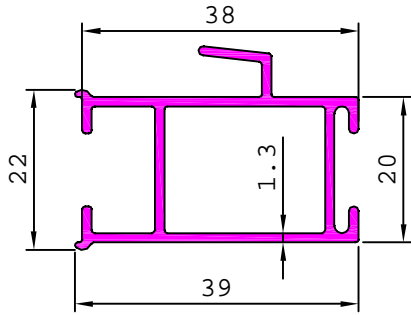

TRACK SECTION

SLIDING WINDOW

(SERIES -20 mm.)

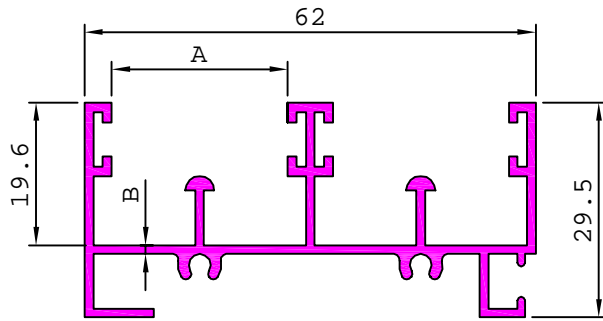

SL. No.	Section No.	A	B	Weight kg/m
1	21053	24.20	1.00	0.630
2	20703	24.20	1.20	0.726
3	21139	23.30	1.50	0.902

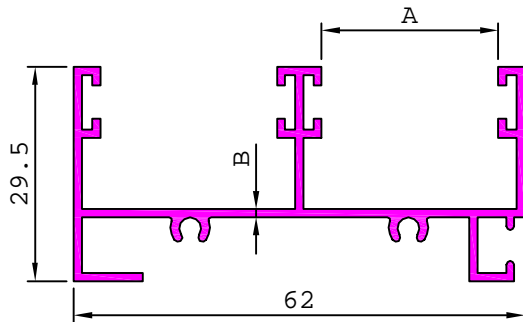

SL. No.	Section No.	A	B	Weight kg/m
1	20987	24.30	1.13	0.615
2	21138	23.30	1.50	0.807

20694

0.695 kg/m

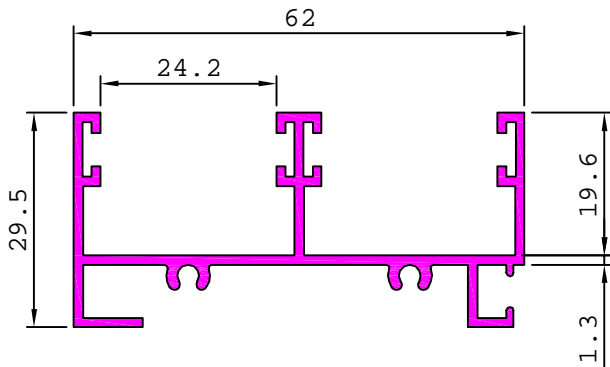

20695

1.088 kg/m

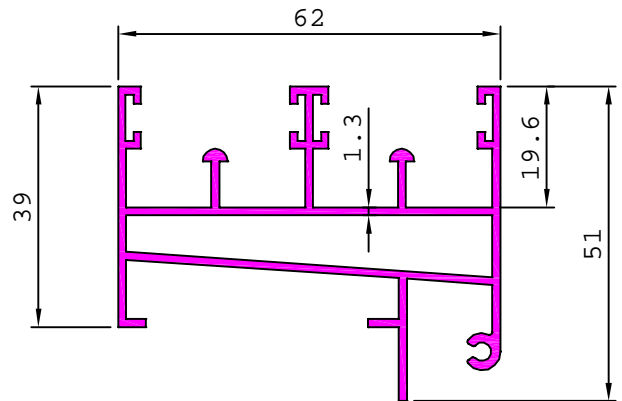

TRACK SECTION SLIDING WINDOW (SERIES -20 mm.)

21894 0.977 kg/m

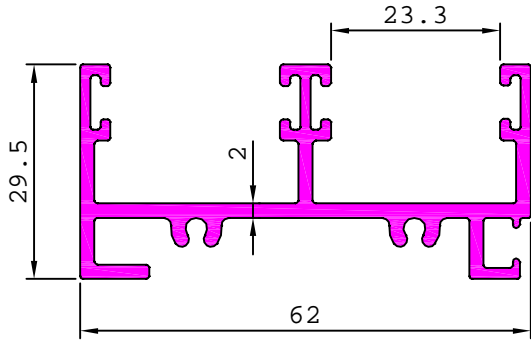

21895 1.092 kg/m

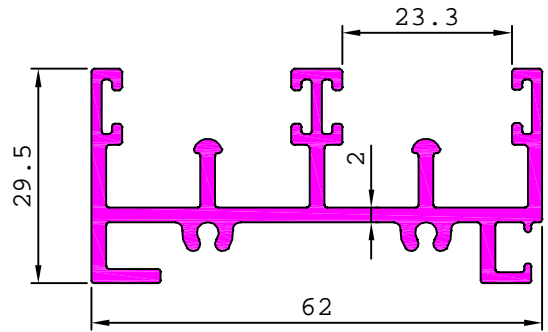

21848 0.554 kg/m

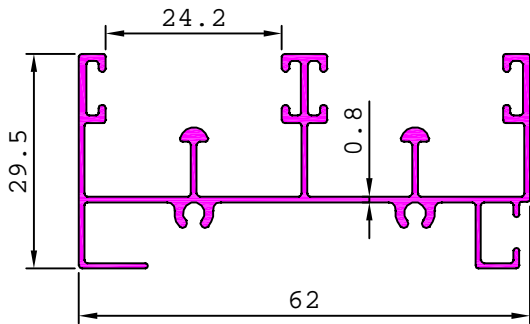

21847 0.517 kg/m

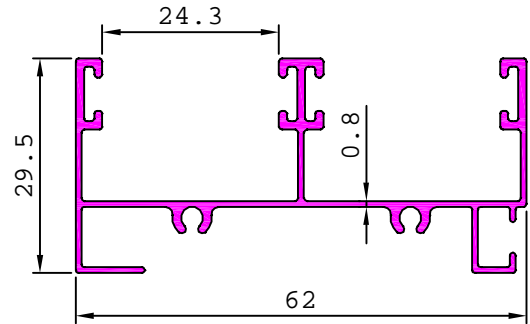

46121 1.105 kg/m

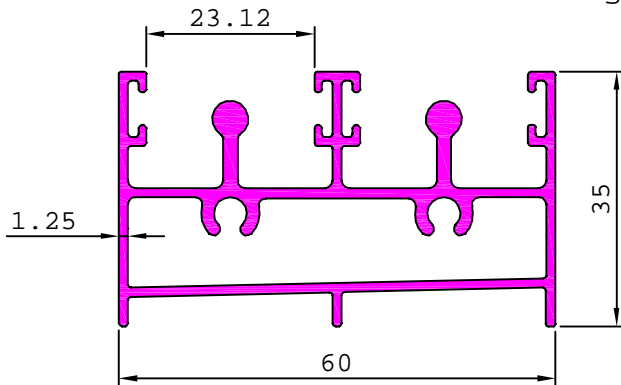

TRACK SECTION

SLIDING WINDOW

(SERIES -20 mm.)

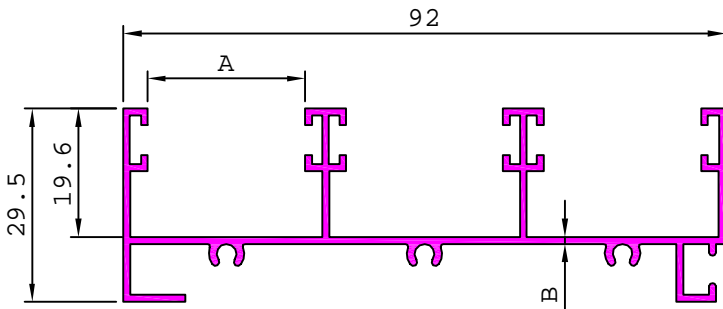

SL. No.	Section No.	A	B	Weight kg/m
1	21054	24.10	1.05	0.777
2	20696	24.10	1.20	0.907
3	20978	23.20	1.40	1.066
4	21137	23.20	1.50	1.102
4	21100	23.05	2.00	1.342

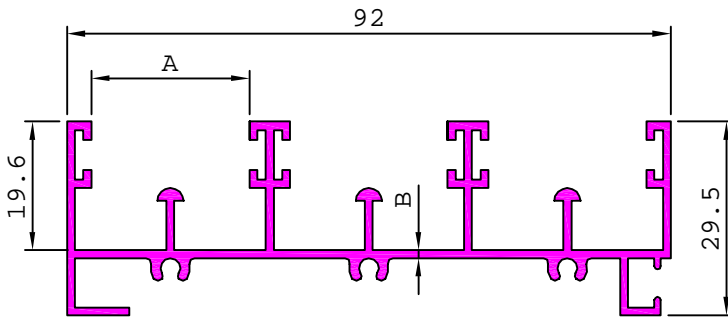

SL. No.	Section No.	A	B	Weight kg/m
1	21055	24.10	1.00	0.866
2	20704	24.10	1.20	1.036
3	20977	23.20	1.45	1.217
4	21099	23.05	2.00	1.516

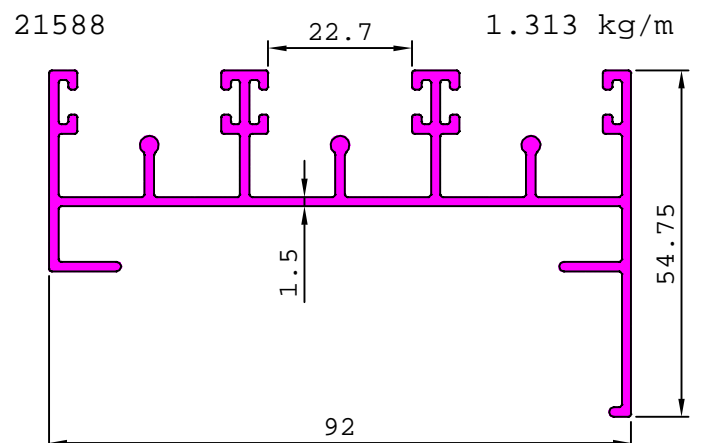
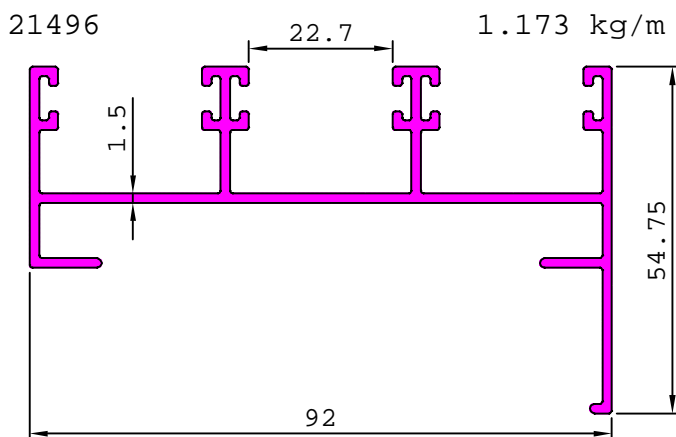
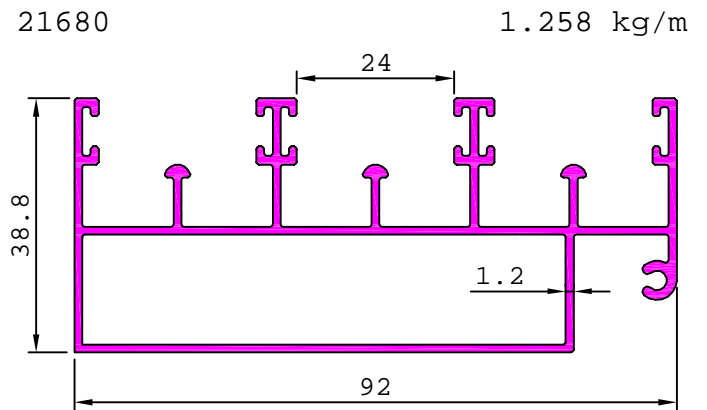
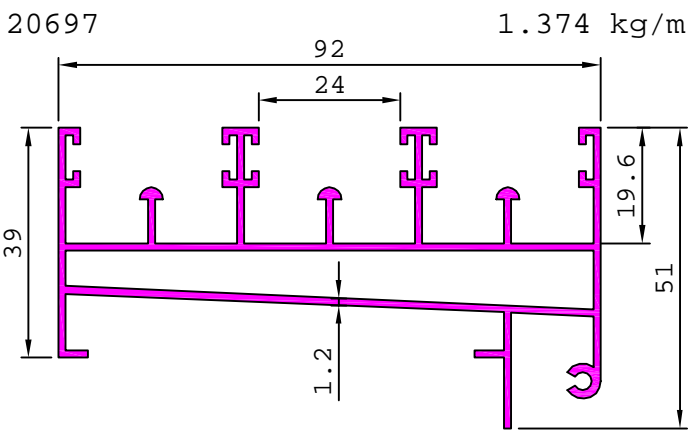

TRACK SECTION

SLIDING WINDOW

(SERIES -20 mm.)

21892

0.648 kg/m

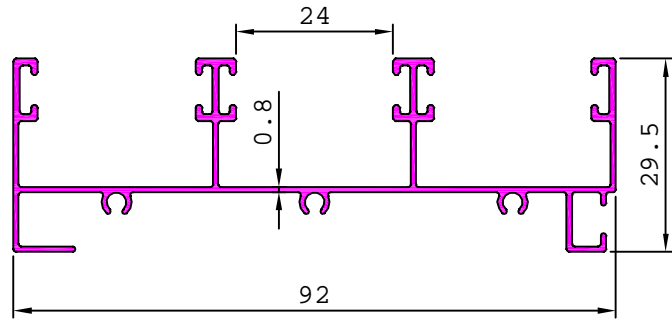

21833

0.748 kg/m

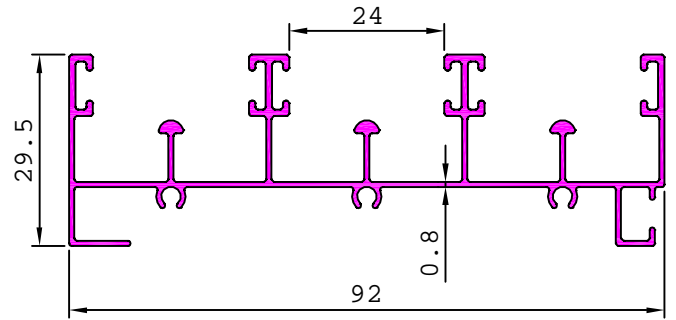

21692

1.369 kg/m

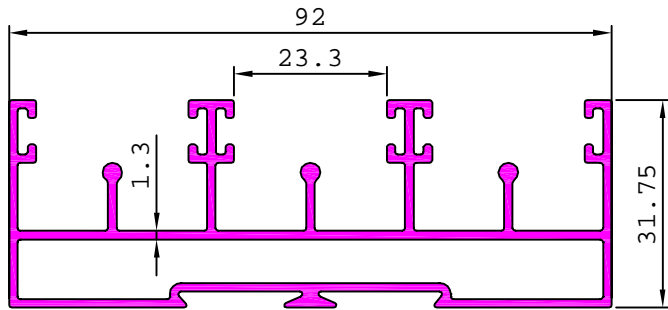

21216

1.233 kg/m

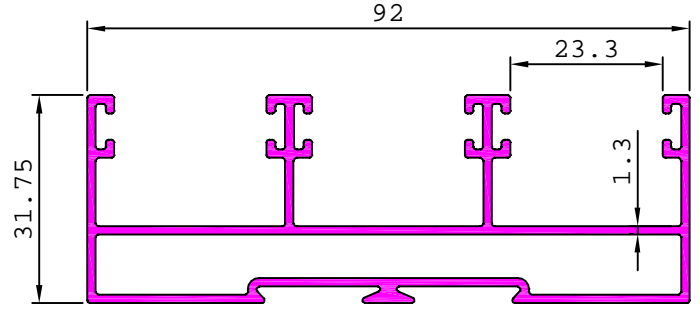

21650

1.685 kg/m

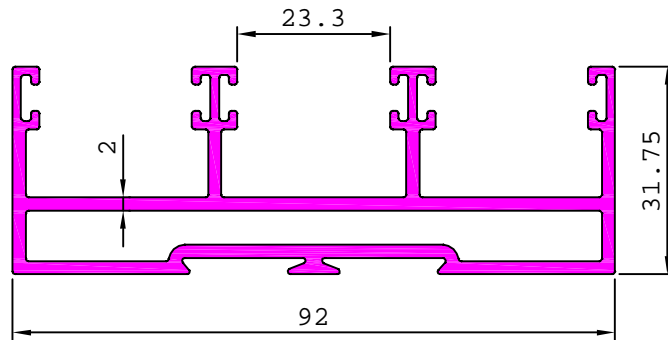

21651

1.864 kg/m

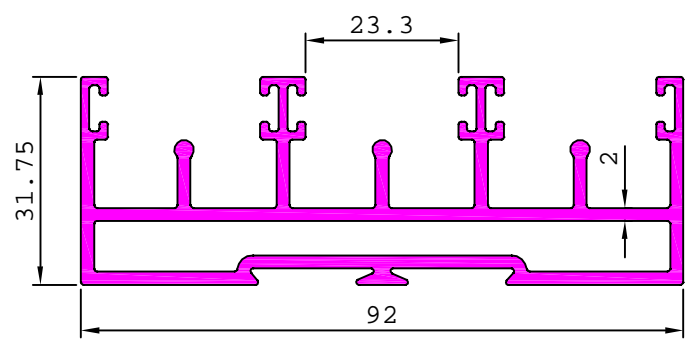

21495

1.174 kg/m

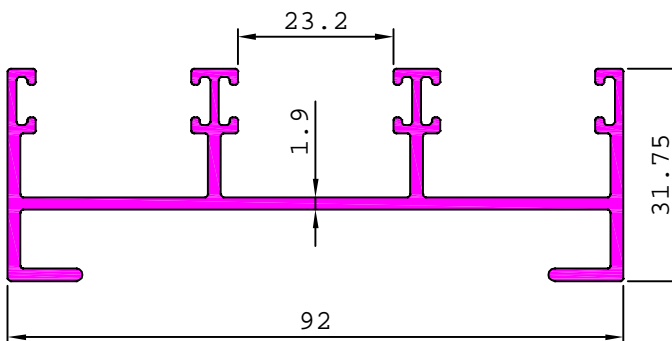

21501

1.336 kg/m

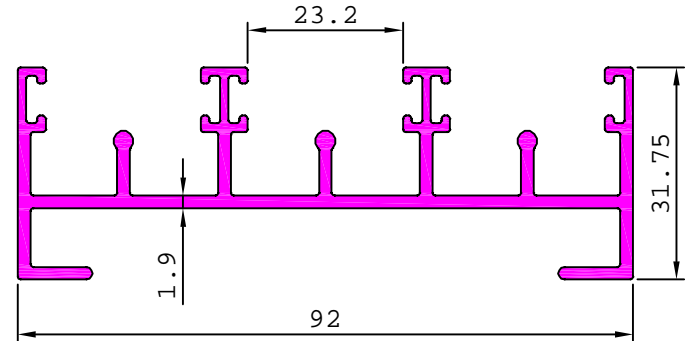

TRACK SECTION

SLIDING WINDOW

(SERIES -20 mm.)

21684

1.356 kg/m

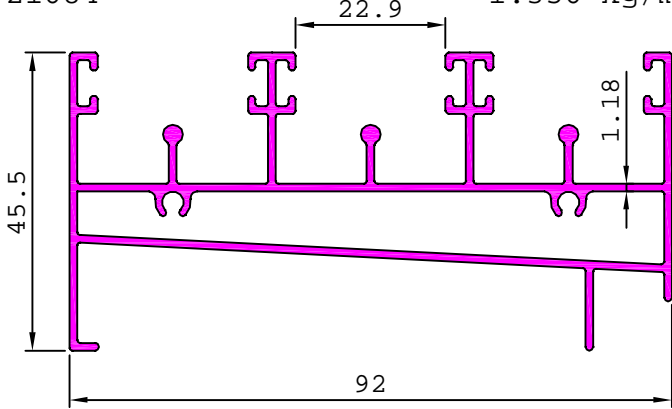

21749

0.933 kg/m

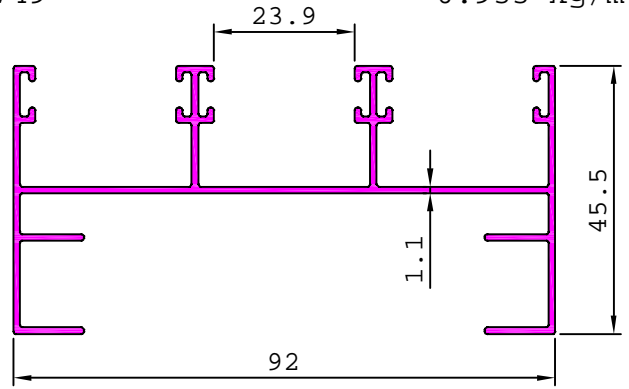

TRACK SECTION

SLIDING WINDOW

(SERIES -20 mm.)

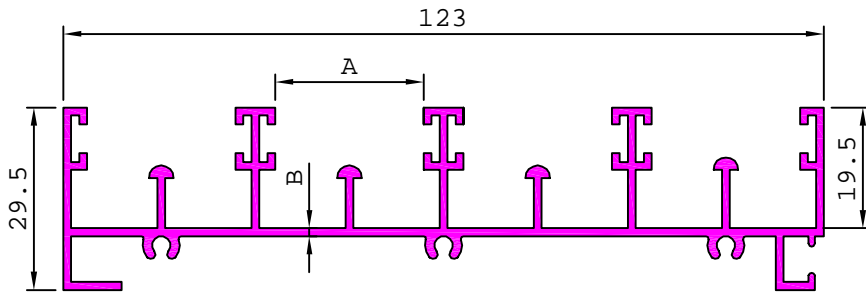

SL. No.	Section No.	A	B	Weight kg/m
1	20910	24.00	1.30	1.394
2	21101	23.30	2.00	1.915

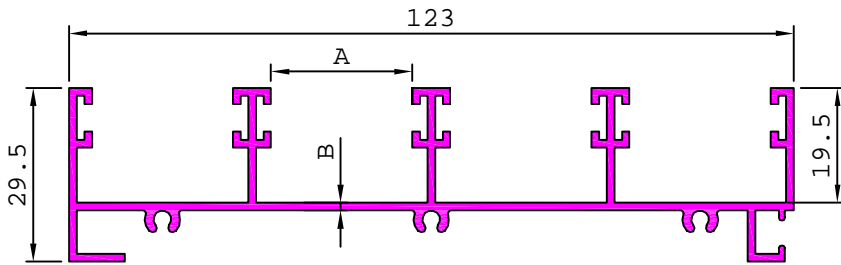

SL. No.	Section No.	A	B	Weight kg/m
1	20911	24.00	1.30	1.207
2	21098	23.30	2.00	1.670

SHUTTER SECTION SLIDING WINDOW (SERIES -25 mm.)

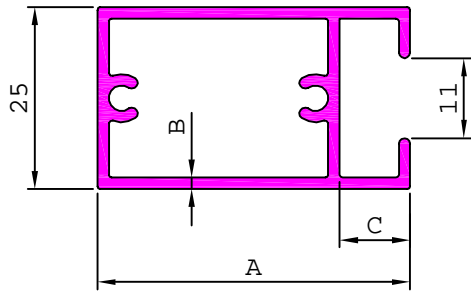

SL. No.	Section No.	A	B	C	Weight kg/m
1	20841	43.00	1.33	9.70	0.569
2	20602	43.00	1.57	9.70	0.665
3	21030	43.00	1.98	9.70	0.828
4	21253	50.00	1.00	12.20	0.483
5	20707	50.00	1.20	12.20	0.593
6	21056	50.00	1.51	12.51	0.717

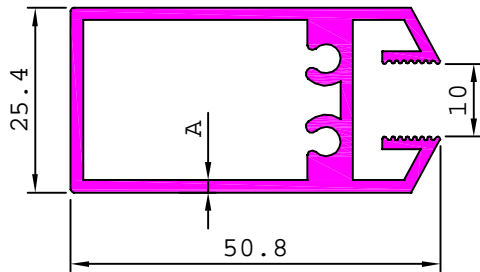

SL. No.	Section No.	A	Weight kg/m
1	21144	1.50	0.797
2	20715	1.70	0.886
3	21361	1.98	1.003

20507

0.642 kg/m

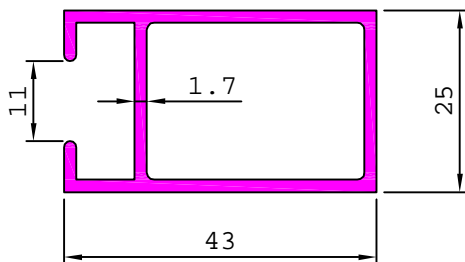

20516

0.560 kg/m

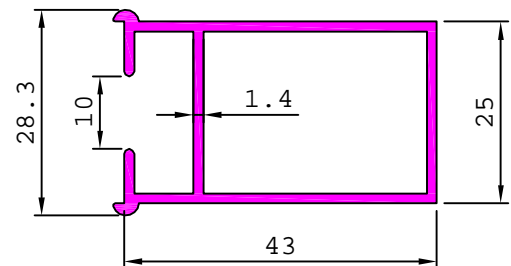

21393

0.508 kg/m

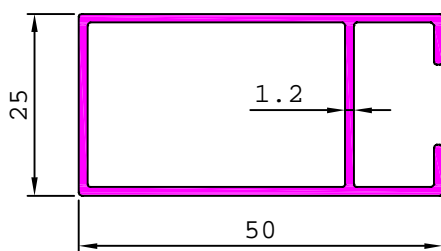

21045

0.475 kg/m

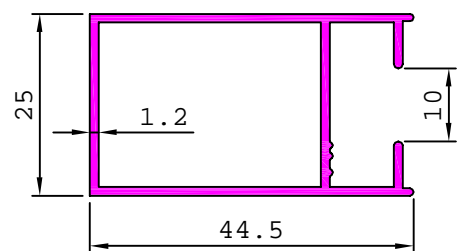

SHUTTER SECTION SLIDING WINDOW (SERIES -25 mm.)

20923

0.895 kg/m

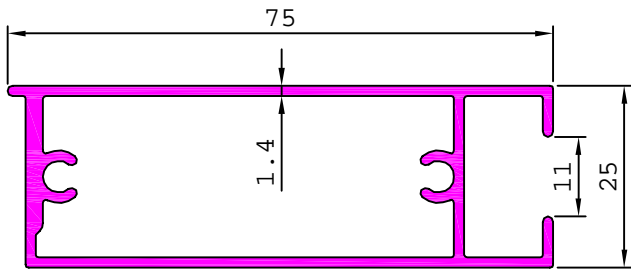

21382

0.779 kg/m

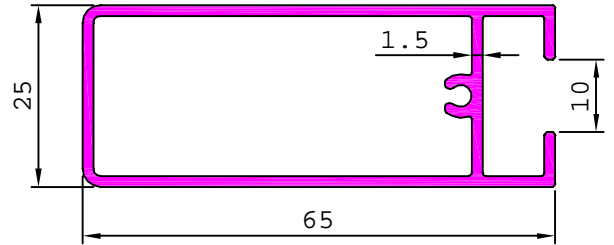

21355

0.598 kg/m

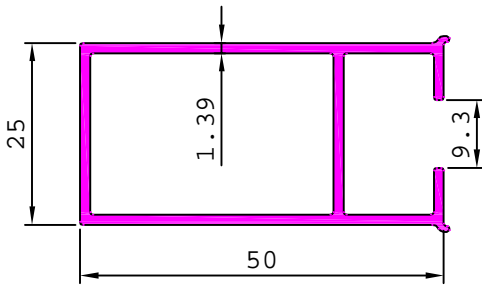

21349

0.887 kg/m

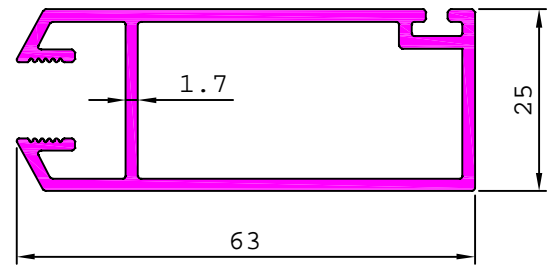

20506

0.717 kg/m

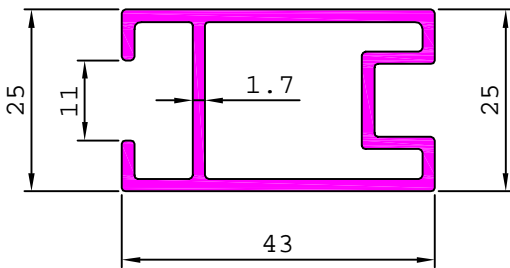

20518

0.675 kg/m

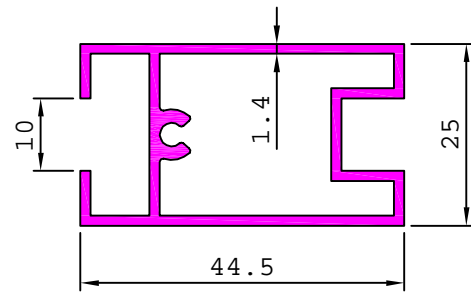

21484

0.833 kg/m

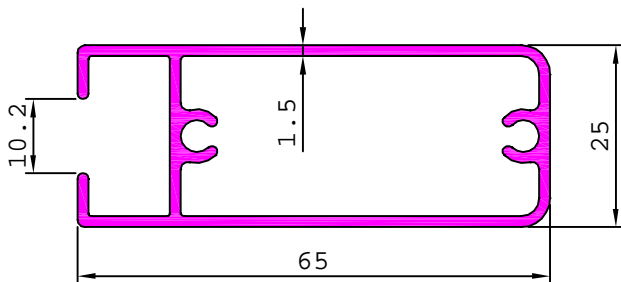

SHUTTER SECTION

SLIDING WINDOW

(SERIES -25 mm.)

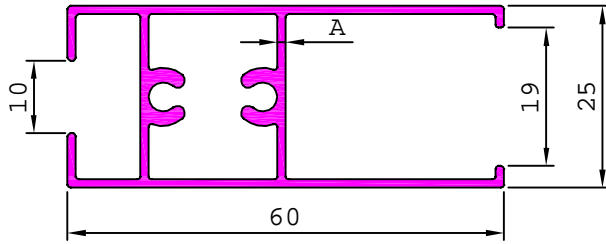

SL. No.	Section No.	A	Weight kg/m
1	20639	1.15	0.678
2	20842	1.45	0.781

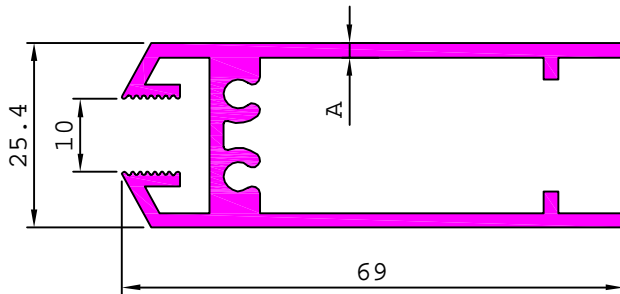

SL. No.	Section No.	A	Weight kg/m
1	21143	1.50	0.882
2	20716	2.00	1.119

20528

0.786 kg/m

20801

1.237 kg/m

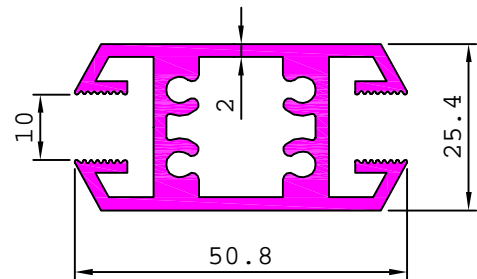
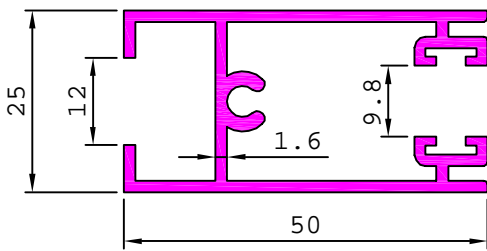

20757

0.602 kg/m

21539

0.638 kg/m

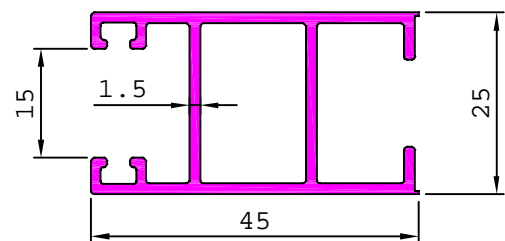
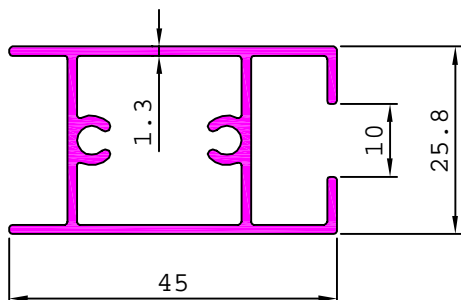

SHUTTER SECTION SLIDING WINDOW (SERIES -25 mm.)

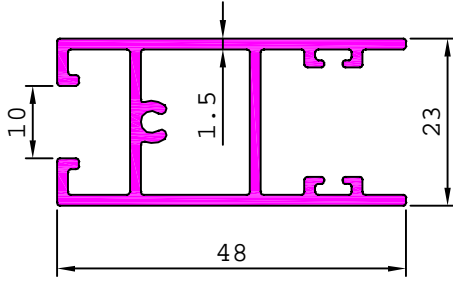
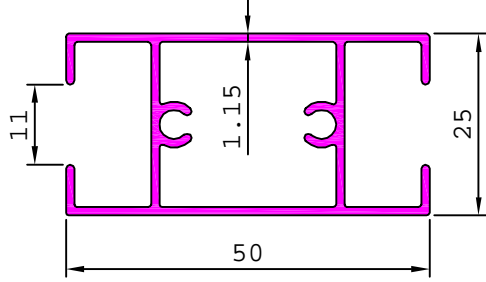
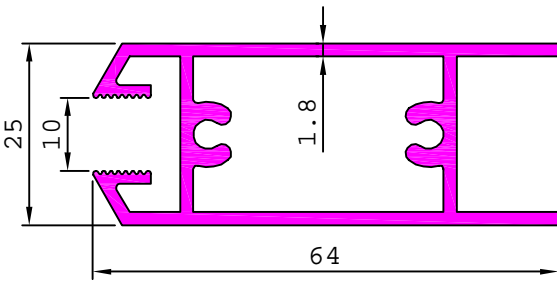
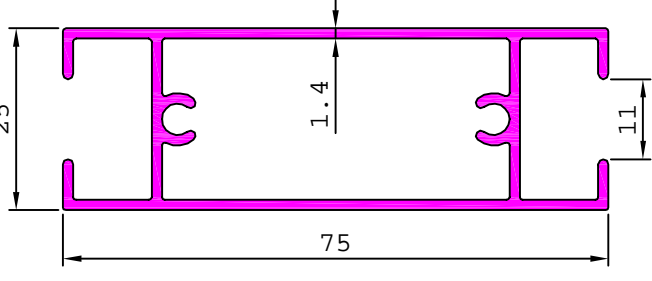
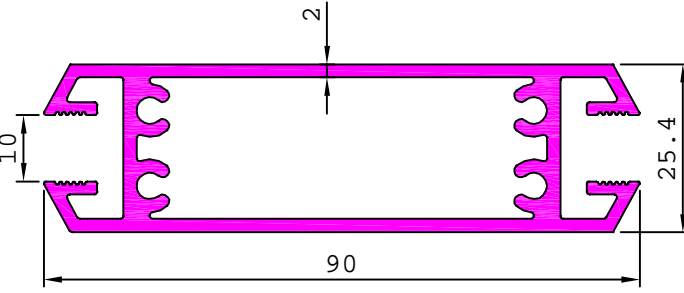
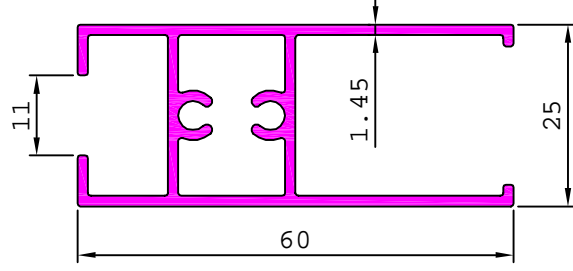
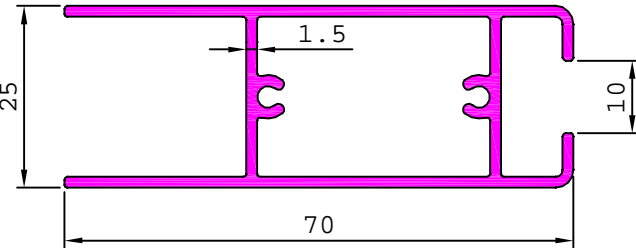
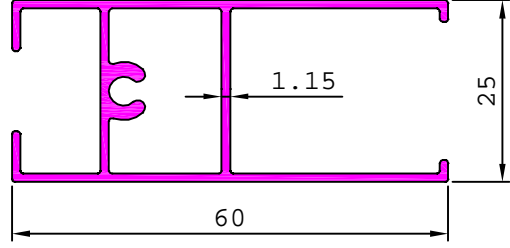
<p>20884 0.685 kg/m</p> 	<p>20921 0.584 kg/m</p> 
<p>20857 1.051 kg/m</p> 	<p>20922 0.925 kg/m</p> 
<p>21398 1.622 kg/m</p> 	<p>21556 0.778 kg/m</p> 
<p>21381 0.851 kg/m</p> 	<p>21394 0.618 kg/m</p> 

SHUTTER SECTION SLIDING WINDOW (SERIES -25 mm.)

21483

0.967 kg/m

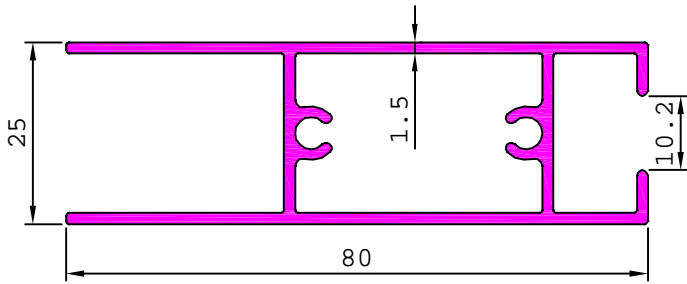

21891

0.645 kg/m

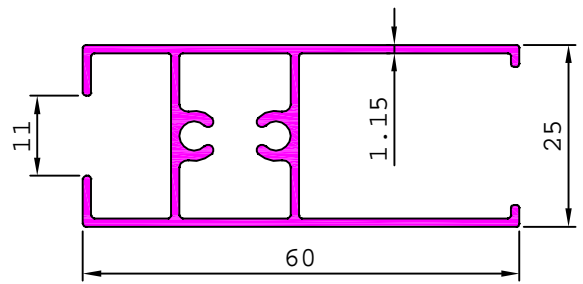

21750

0.701 kg/m

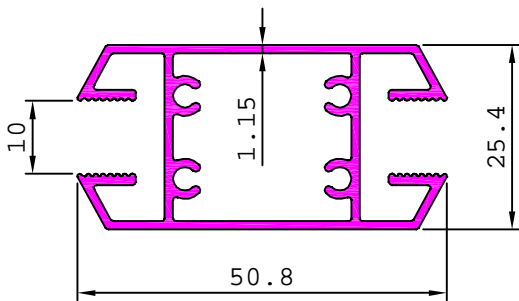

21930

0.488 kg/m

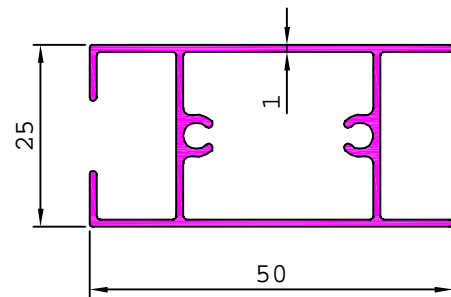

21354

0.685 kg/m

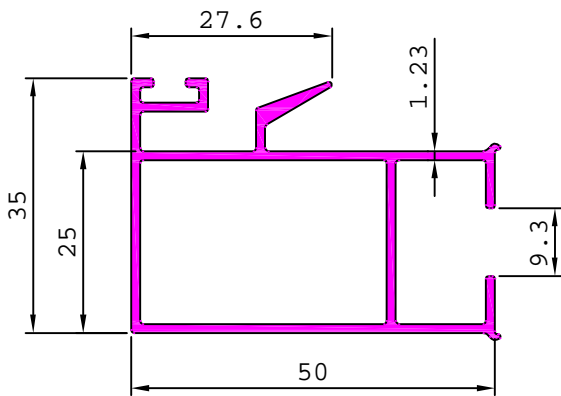

20517

0.698 kg/m

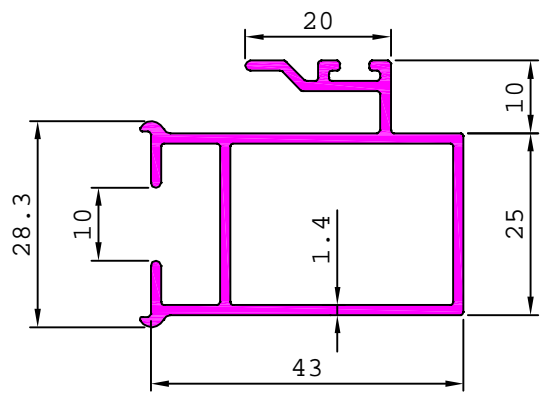

INTERLOCK SECTION

SLIDING WINDOW

(SERIES -25 mm.)

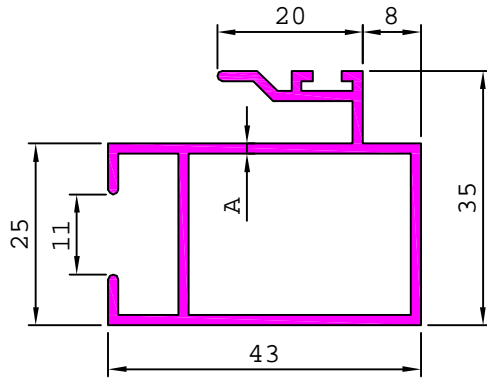

SL. No.	Section No.	A	Weight kg/m
1	20939	1.40	0.678
2	20508	1.70	0.802

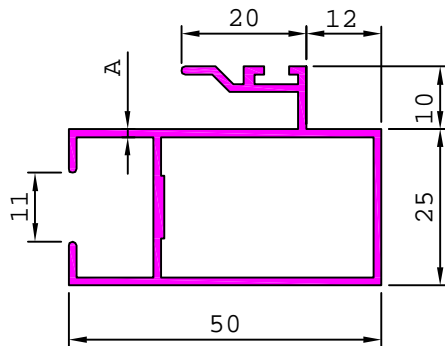

SL. No.	Section No.	A	Weight kg/m
1	20741	1.30	0.683
2	21091	1.48	0.776

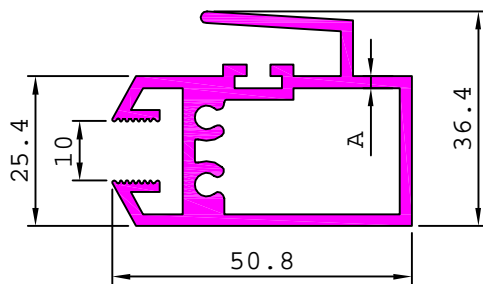

SL. No.	Section No.	A	Weight kg/m
1	21145	1.50	0.985
2	20711	1.68	1.090

21380

0.901 kg/m

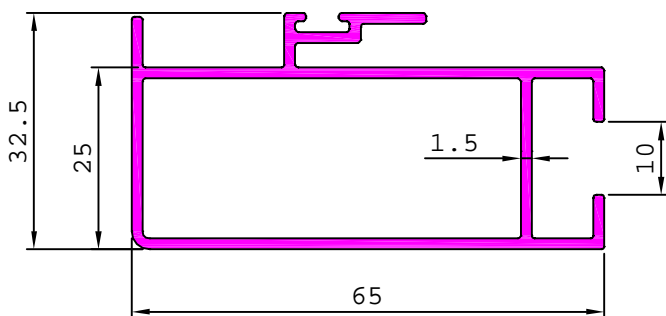

INTERLOCK SECTION **SLIDING WINDOW** (SERIES -25 mm.)

21437

0.637 kg/m

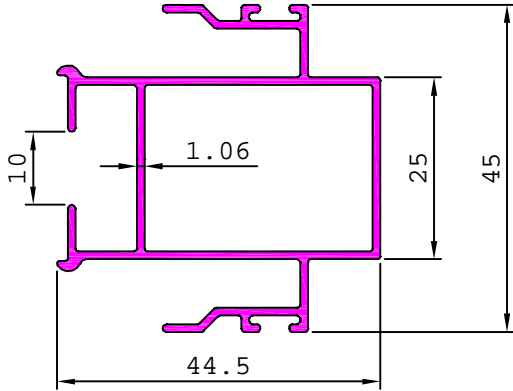

21485

0.893 kg/m

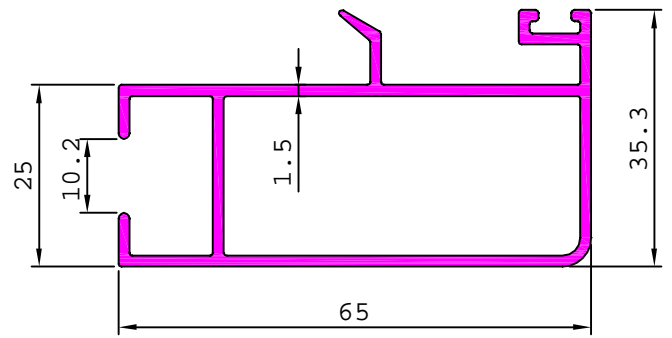

21928

1.488 kg/m

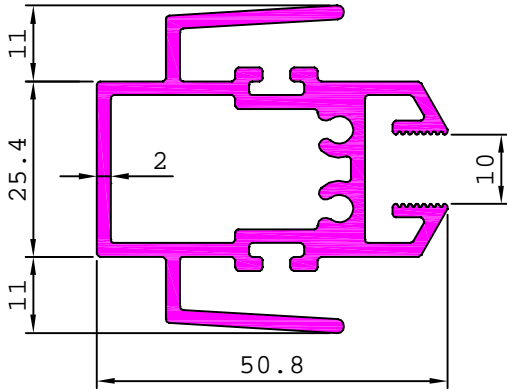

G101398

0.649 kg/m

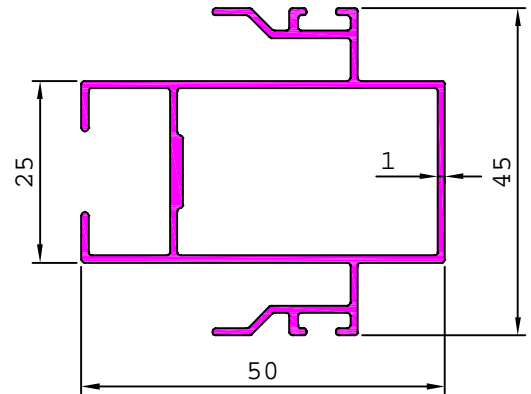

G101525

0.659 kg/m

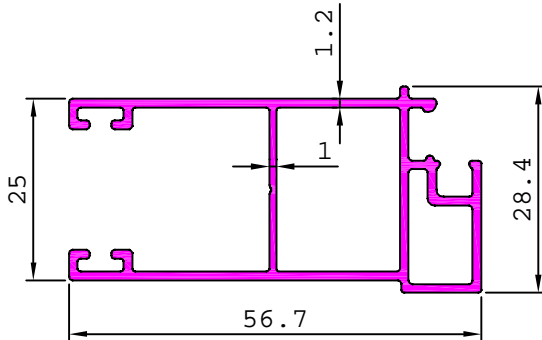

G101526

0.598 kg/m

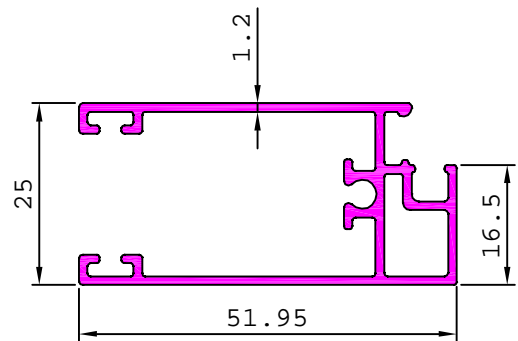

G101527

0.550 kg/m

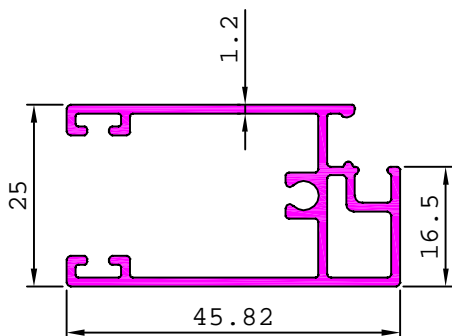

TRACK SECTION SLIDING WINDOW (SERIES -25 mm.)

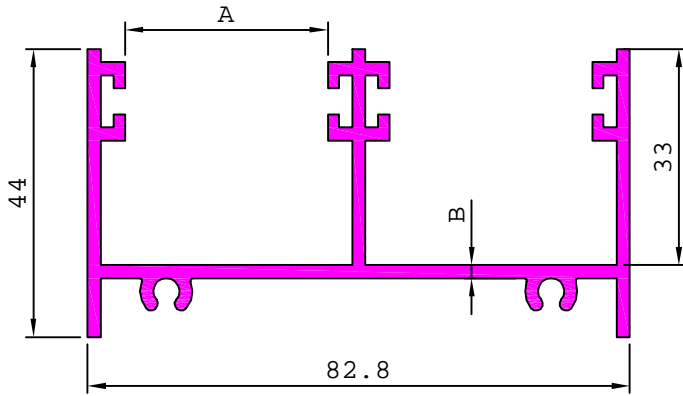

SL. No.	Section No.	A	B	Weight kg/m
1	21147	32.15	1.50	1.073
2	20713	31.00	2.00	1.429

20873 0.846 kg/m

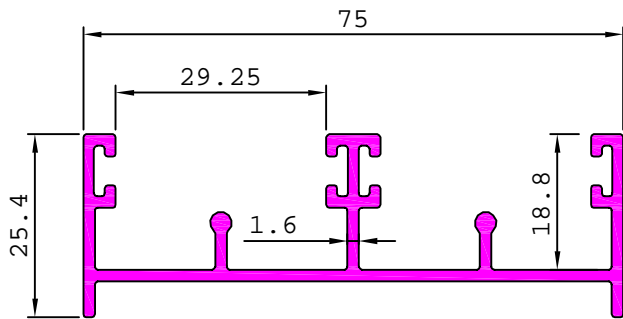

20874 0.800 kg/m

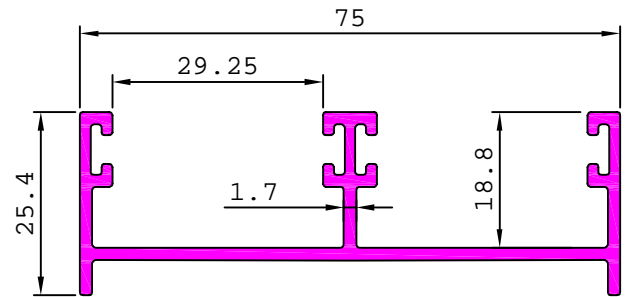

20633 0.676 kg/m

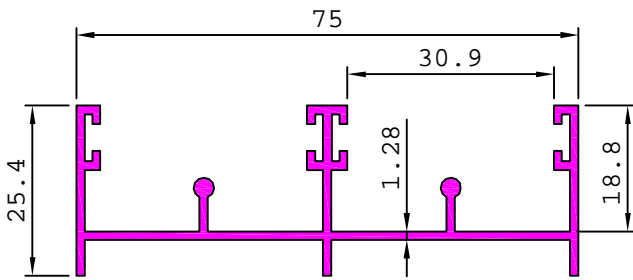

20634 0.619 kg/m

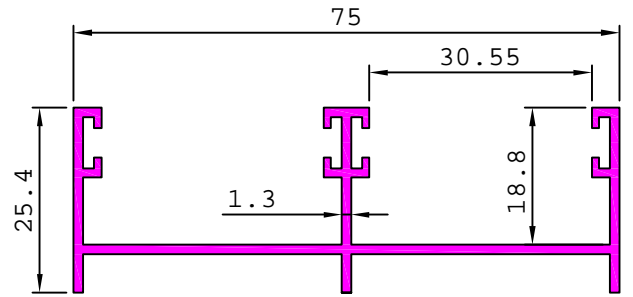

20676 1.075 kg/m

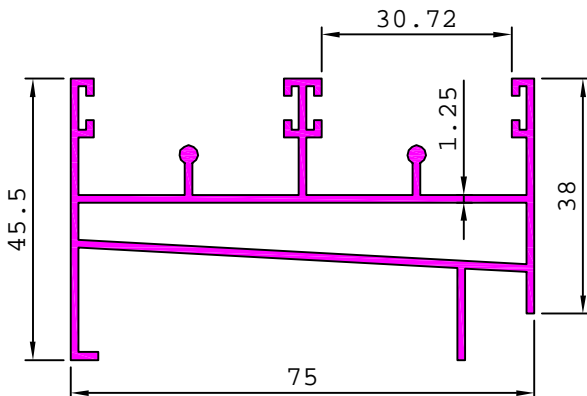

21841 1.135 kg/m

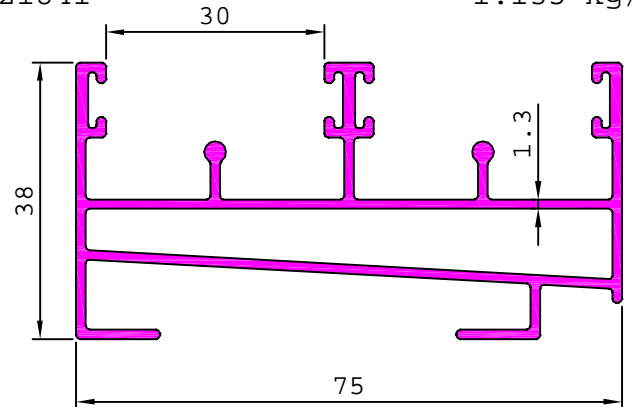

TRACK SECTION **SLIDING WINDOW** (SERIES -25 mm.)

21830 0.806 kg/m

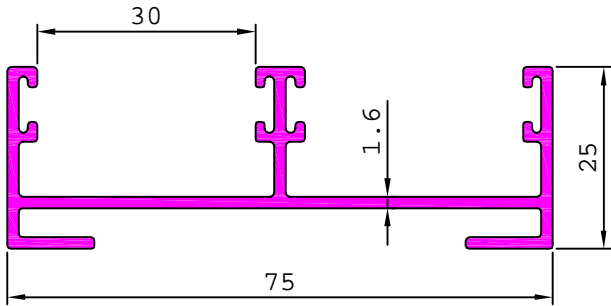

20732 0.669 kg/m

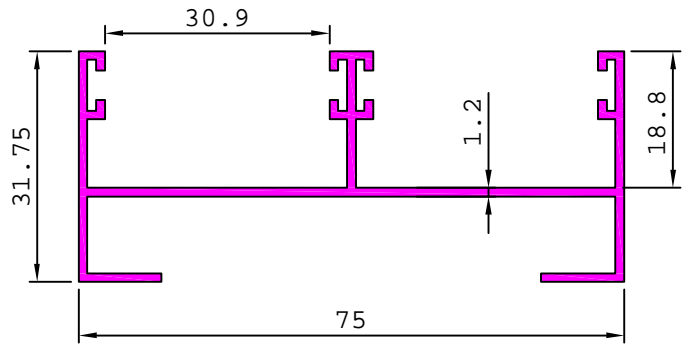

21346 0.735 kg/m

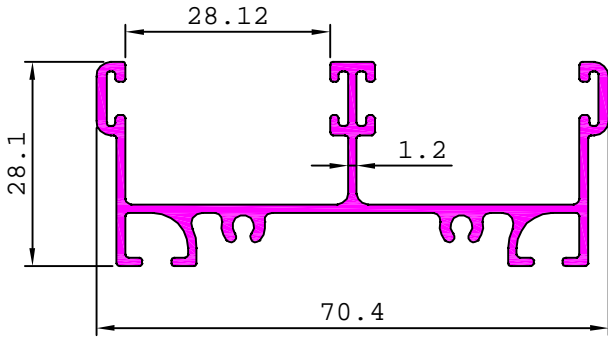

21460 0.621 kg/m

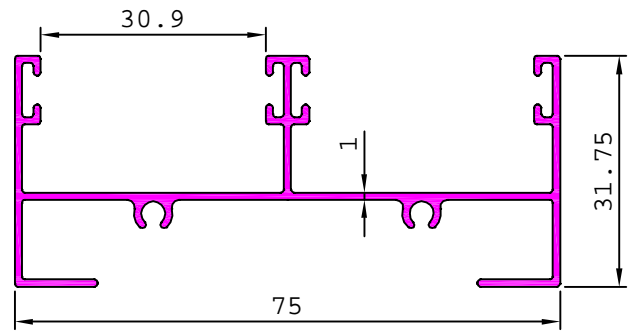

21146 1.308 kg/m

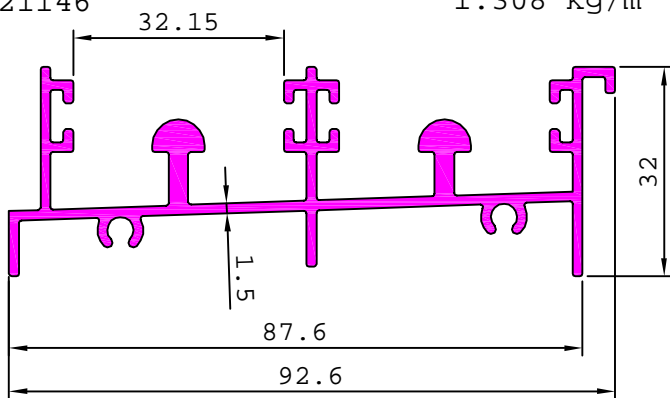

20712 1.805 kg/m

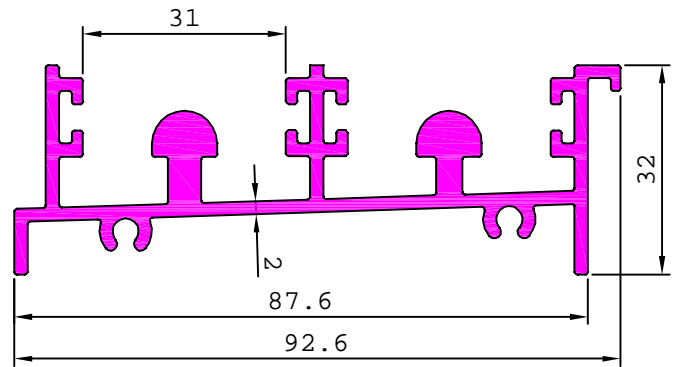

20717 2.572 kg/m

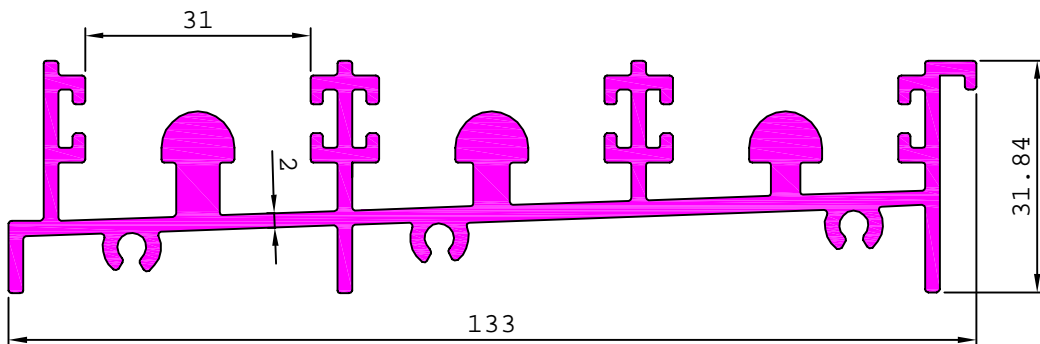

TRACK SECTION

SLIDING WINDOW

(SERIES -25 mm.)

21148

1.842 kg/m

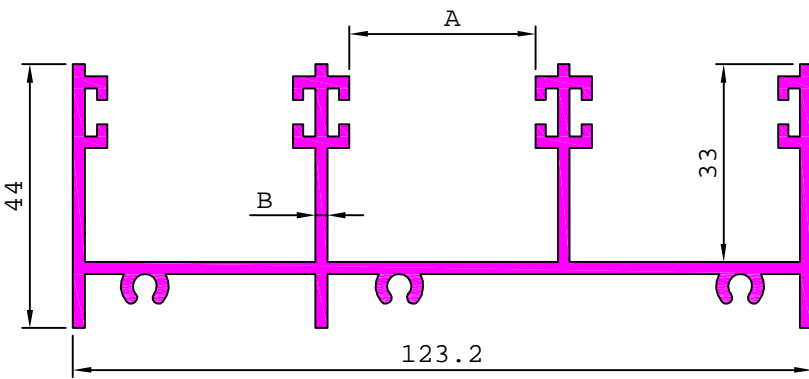
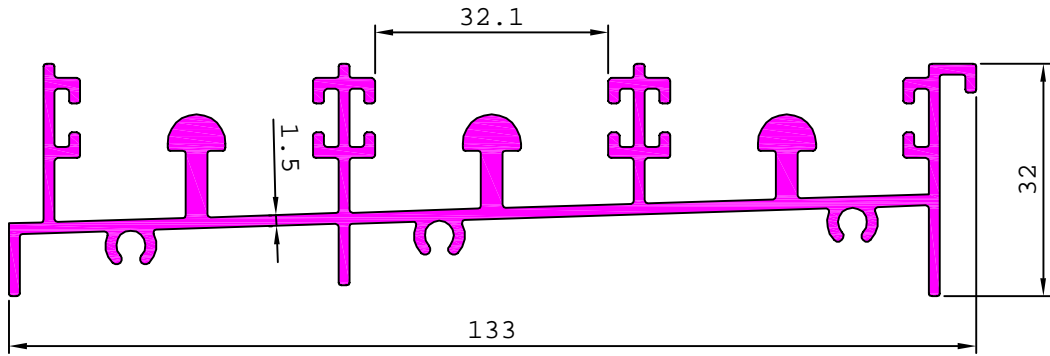

SL. No.	Section No.	A	B	Weight kg/m
1	21149	32.10	1.50	1.539
2	20714	31.00	2.00	2.062

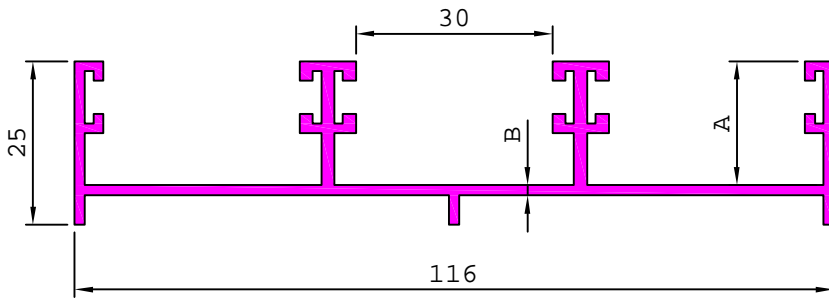

SL. No.	Section No.	A	B	Weight kg/m
1	21032	19.10	1.40	1.005
2	20678	18.90	1.70	1.194

21589

1.300 kg/m

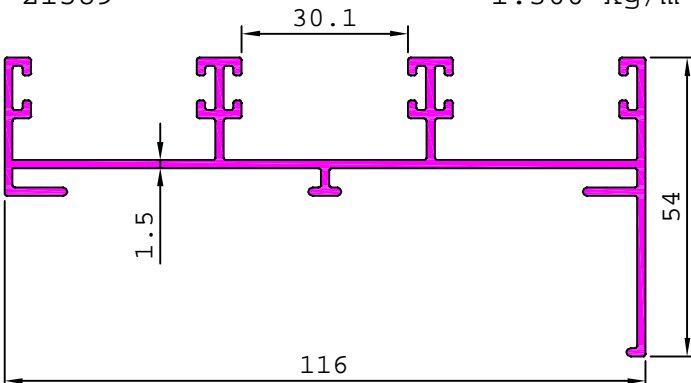

TRACK SECTION SLIDING WINDOW (SERIES -25 mm.)

20799 2.339 kg/m

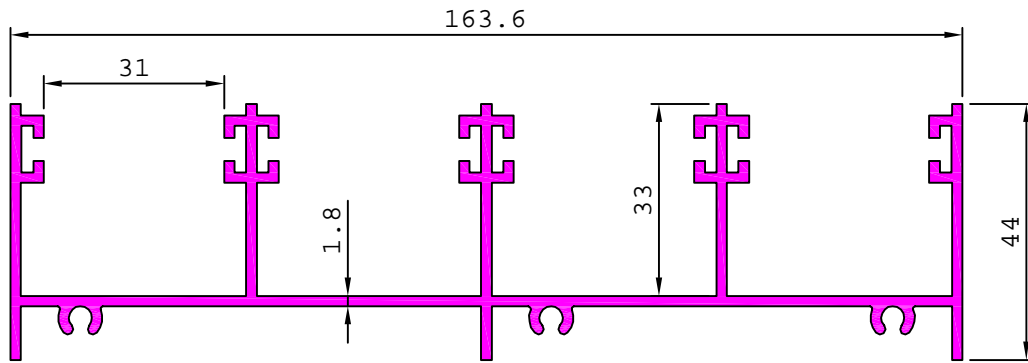

20677 1.674 kg/m

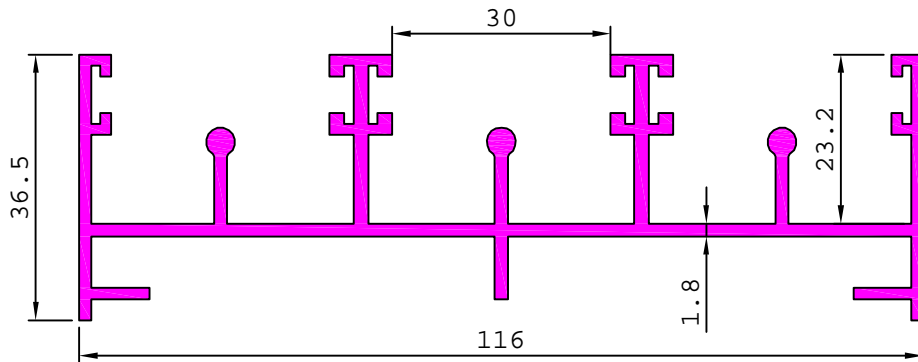

20798 1.160 kg/m

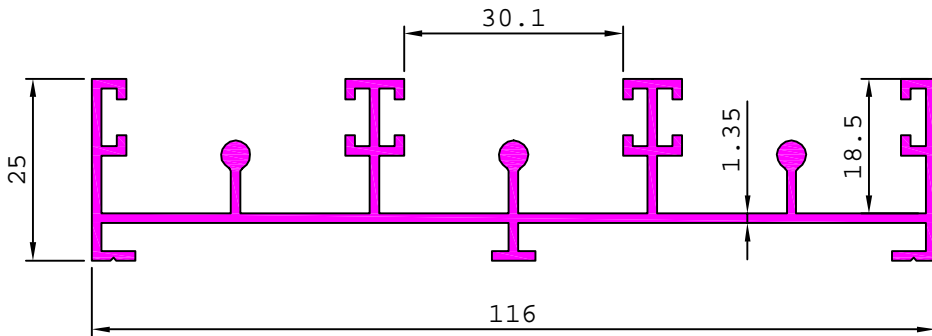

21462 0.909 kg/m

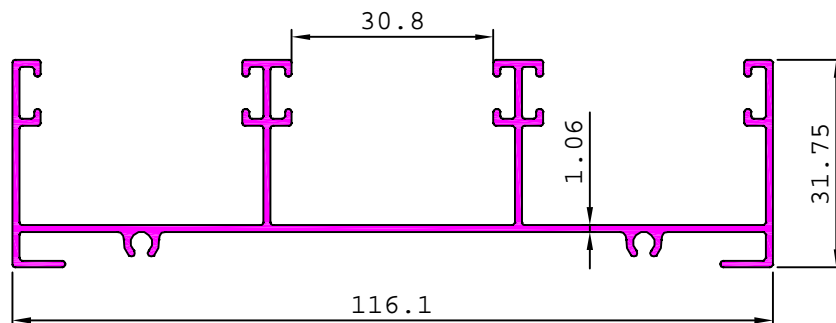

TRACK SECTION SLIDING WINDOW (SERIES -25 mm.)

21840

1.039 kg/m

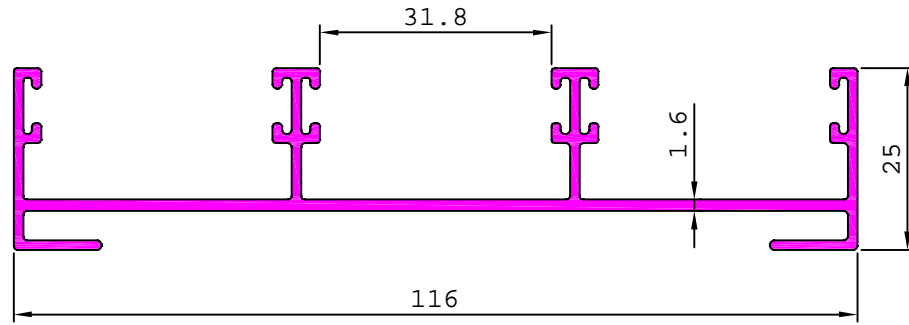

20673

1.619 kg/m

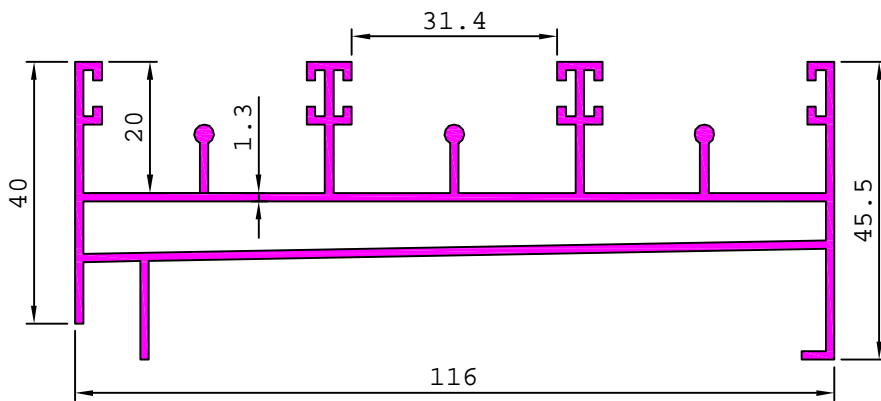

21304

1.082 kg/m

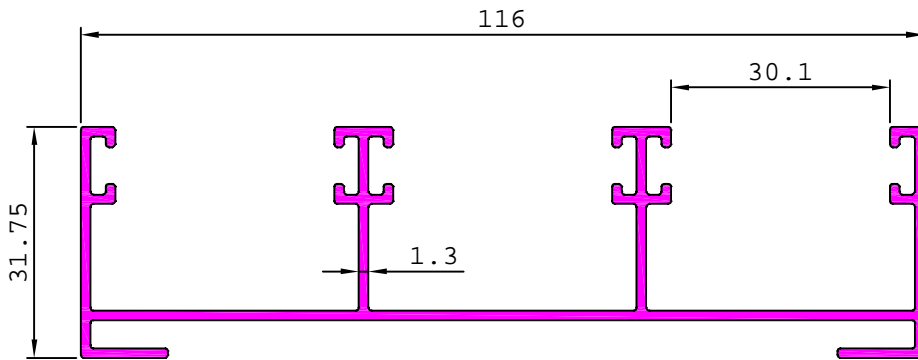

TRACK SECTION **SLIDING WINDOW** (SERIES -25 mm.)

21842

1.673 kg/m

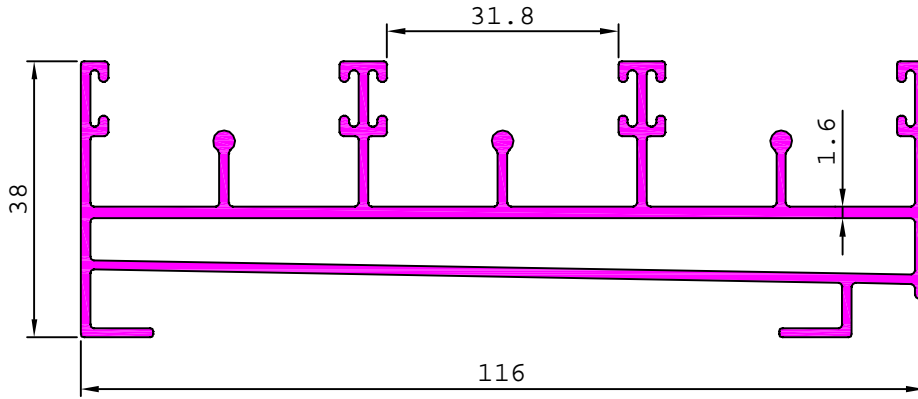

21878

1.668 kg/m

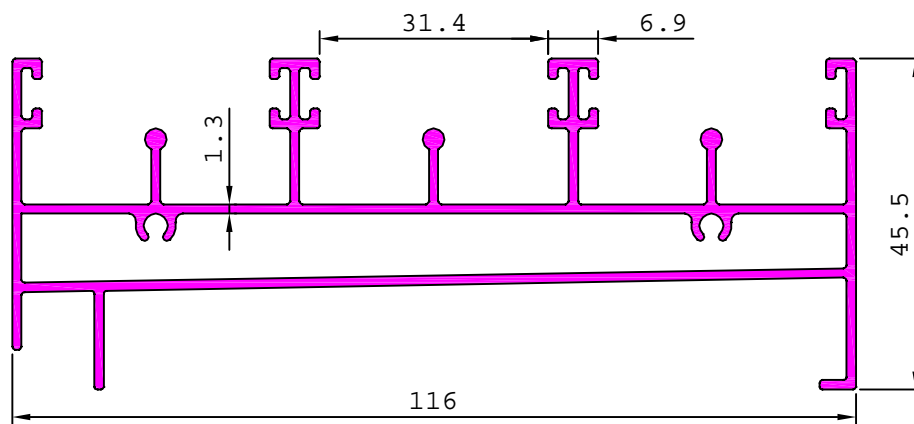

S6263

1.659 kg/m

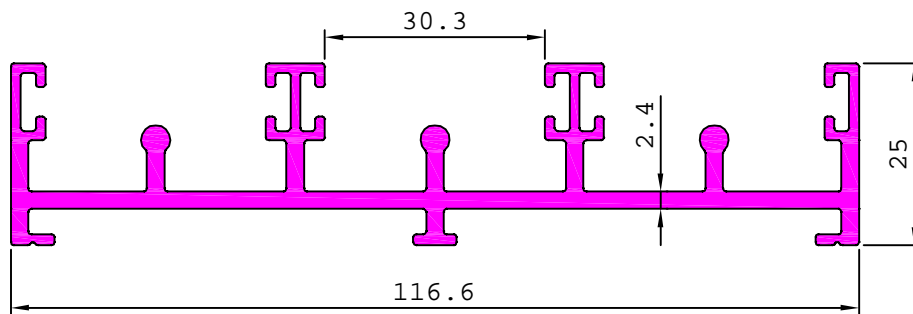

S6264

1.455 kg/m

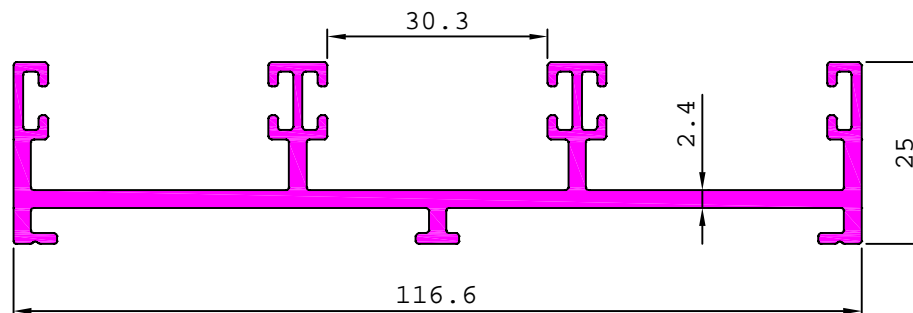

TRACK SECTION **SLIDING WINDOW** (SERIES -25 mm.)

20800 3.160 kg/m

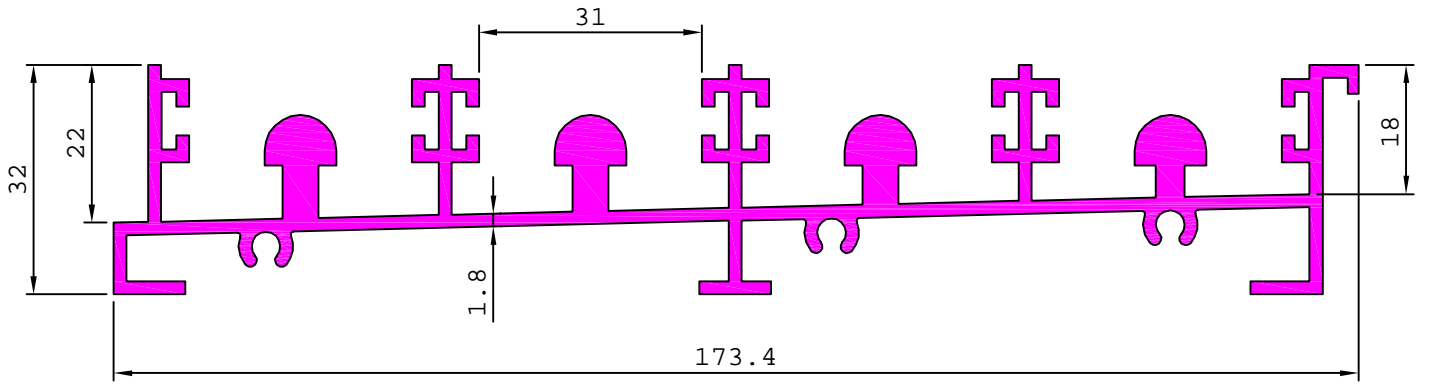

20796 1.434 kg/m

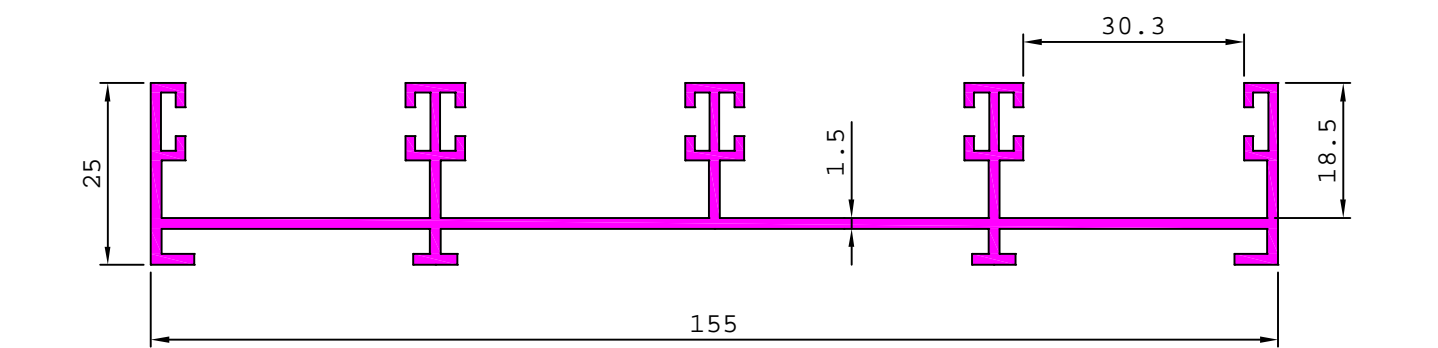

20797 1.667 kg/m

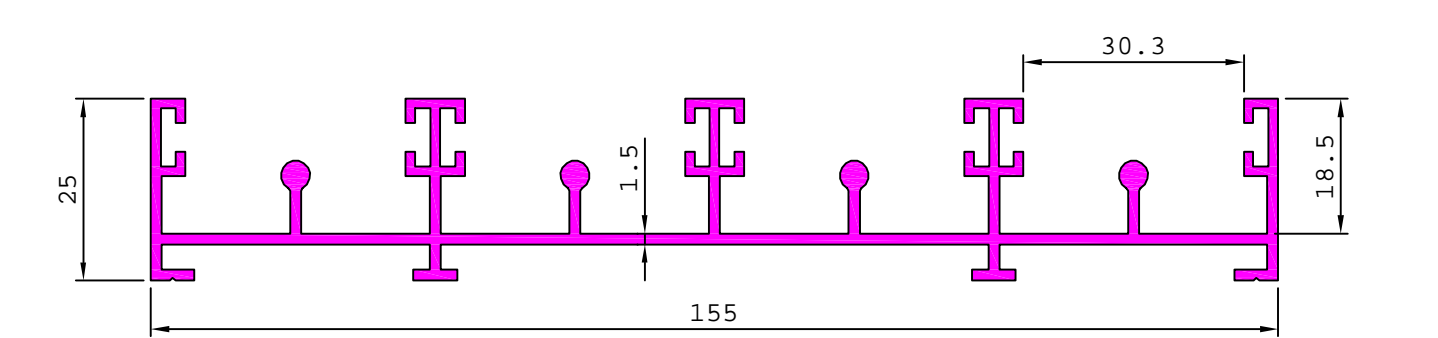

21321 2.329 kg/m

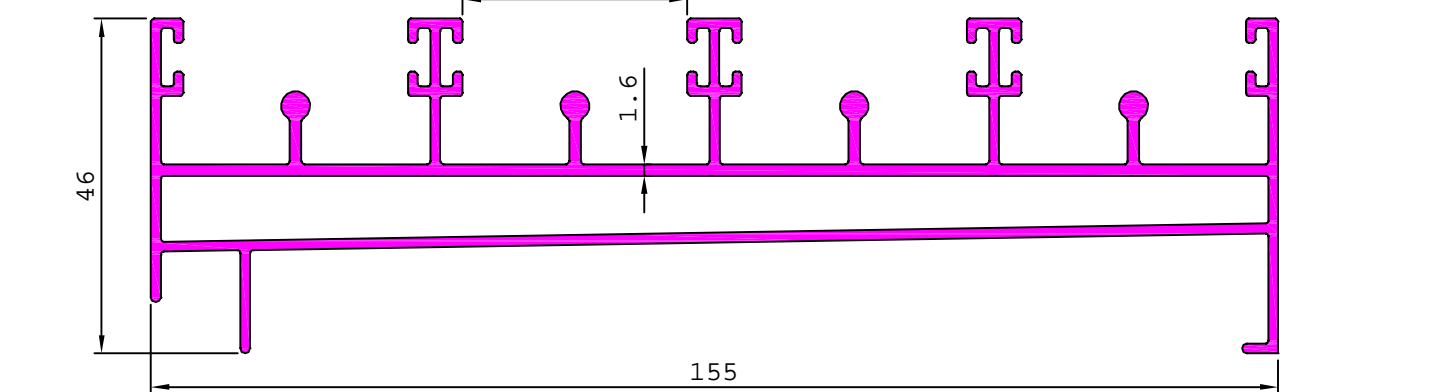

TRACK SECTION

SLIDING WINDOW

(SERIES -25 mm.)

S6099

2.182 kg/m

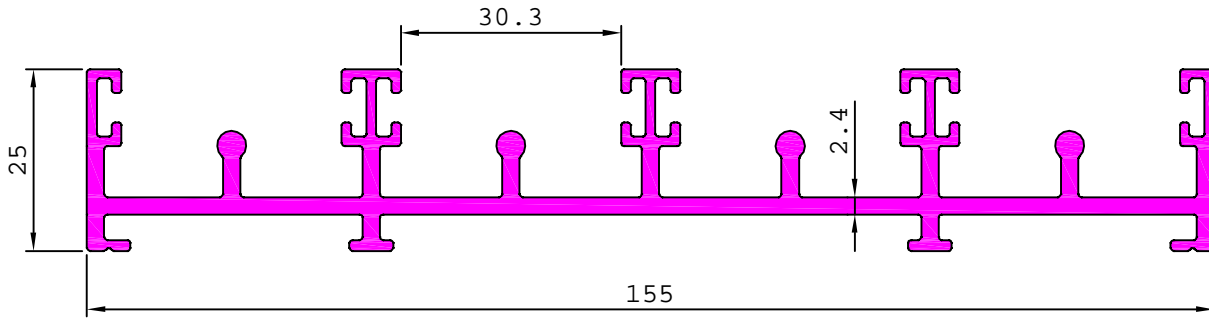

S6100

1.909 kg/m

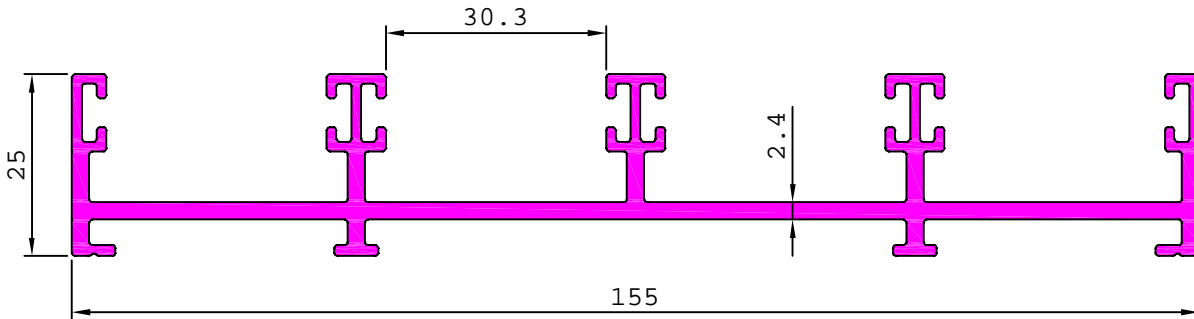

G101395

0.831 kg/m

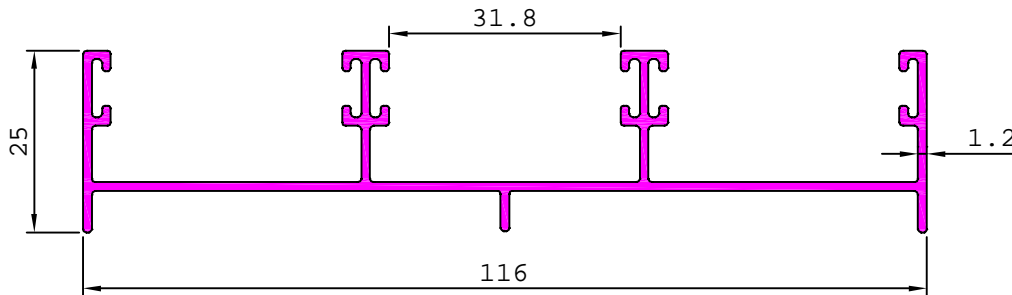

G101396

0.967 kg/m

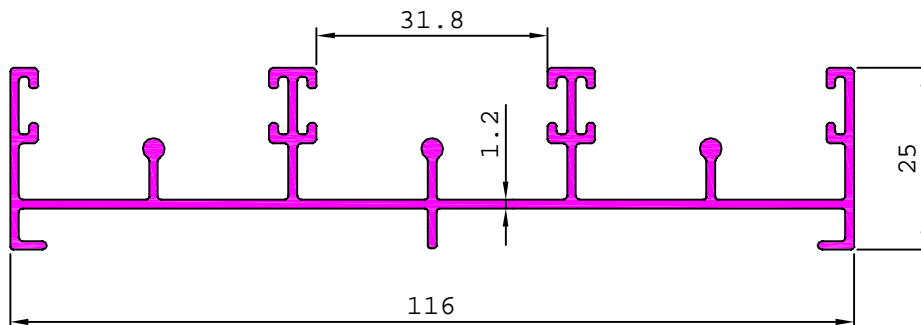

TRACK SECTION SLIDING WINDOW (SERIES -25 mm.)

21570

1.733 kg/m

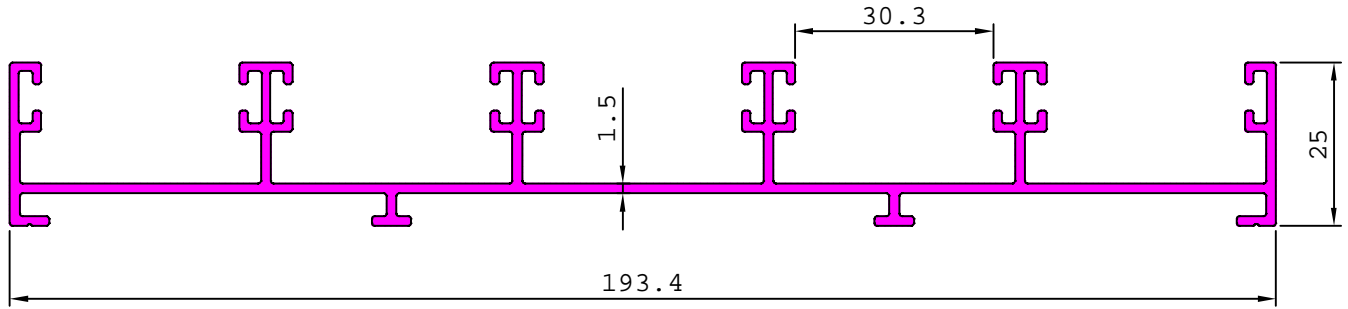

21571

2.026 kg/m

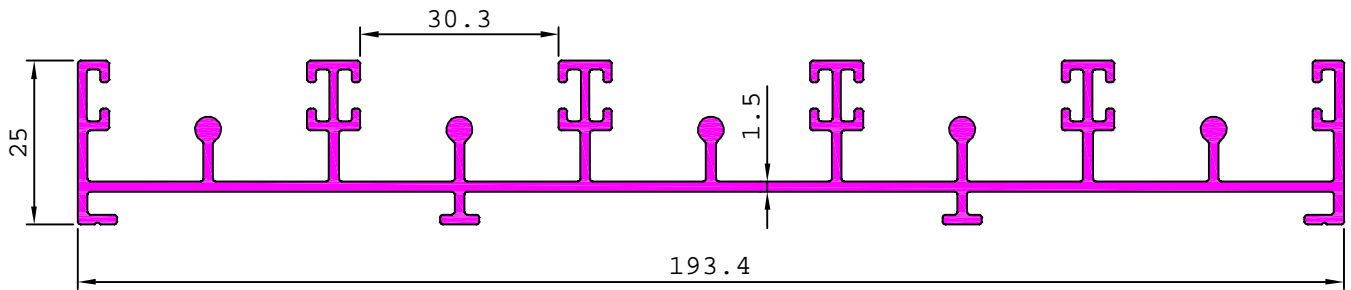

SHUTTER SECTION SLIDING WINDOW (SERIES -30 mm.)

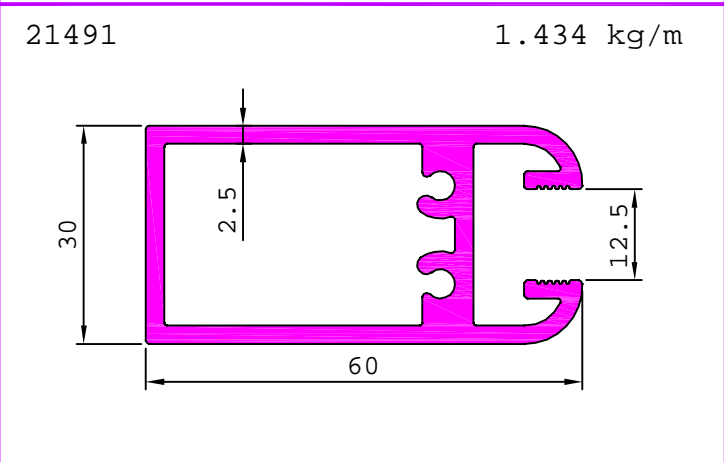
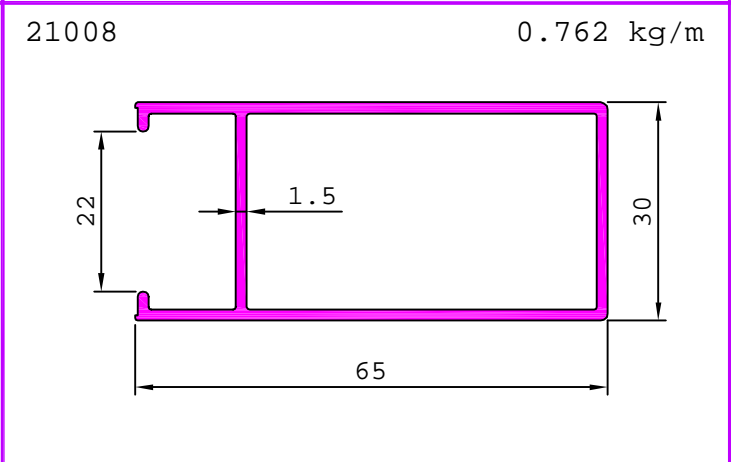
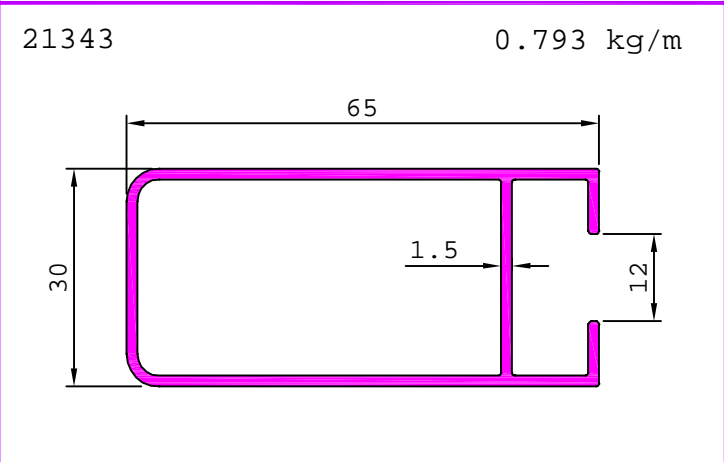
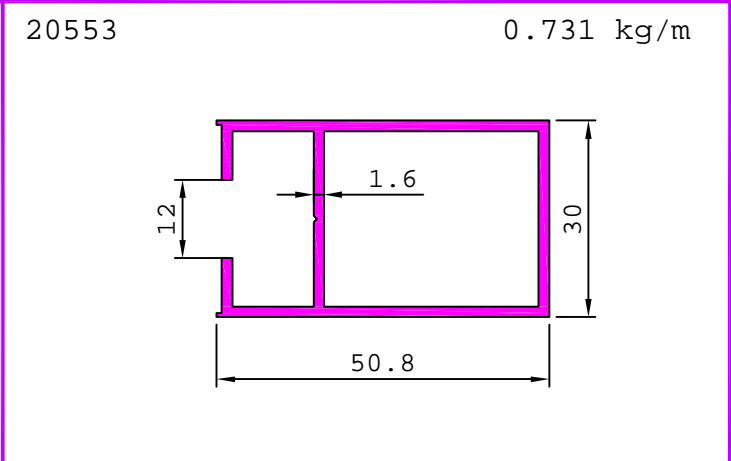
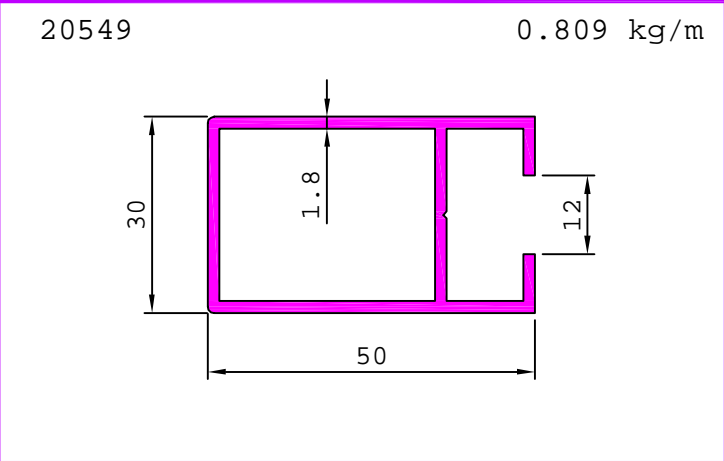

SHUTTER SECTION SLIDING WINDOW (SERIES -30 mm.)

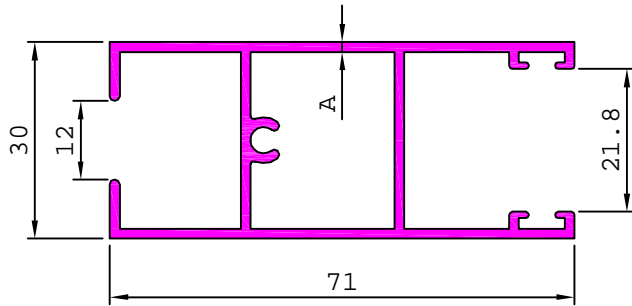

SL. No.	Section No.	A	Weight kg/m
1	20993	1.31	0.839
2	20772	1.50	0.948

20859 0.775 kg/m

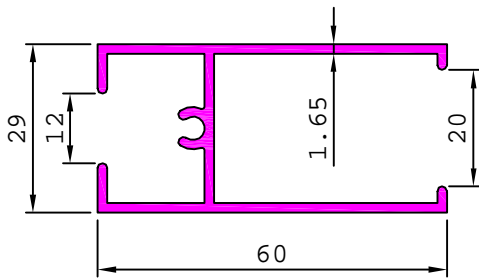

20979 0.950 kg/m

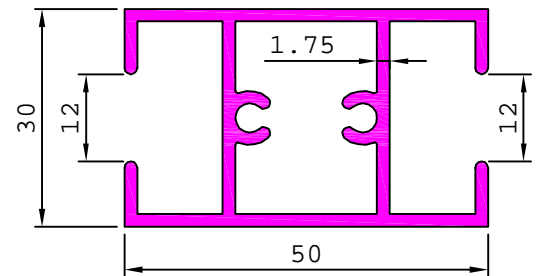

21010 0.995 kg/m

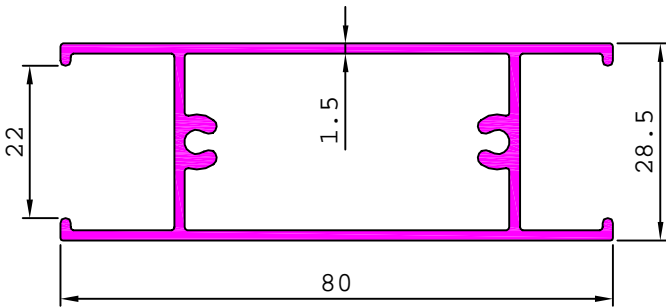

21246 1.305 kg/m

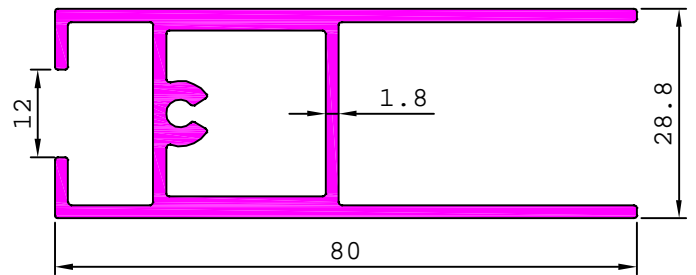

21345 1.010 kg/m

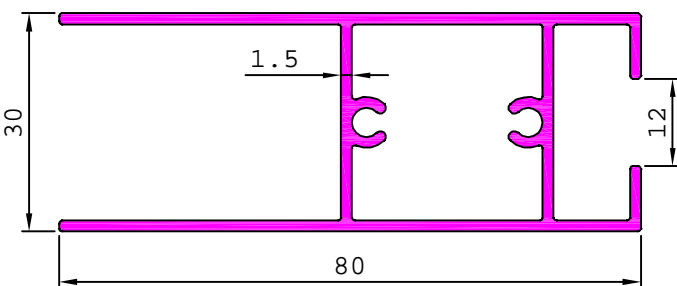

21412 0.592 kg/m

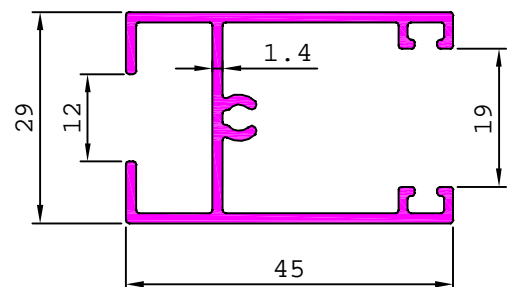

SLIDING WINDOW

(SERIES -30 mm.)

SHUTTER SECTION

21702

0.999 kg/m

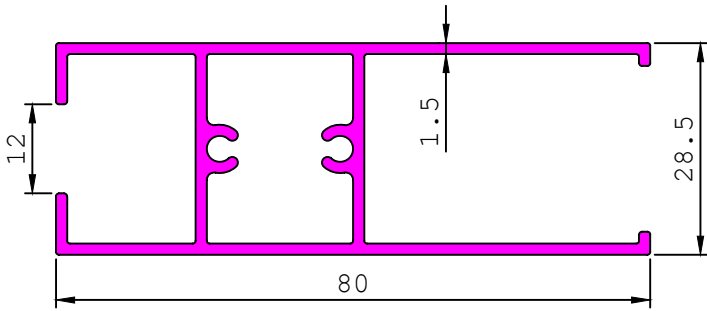

21492

1.720 kg/m

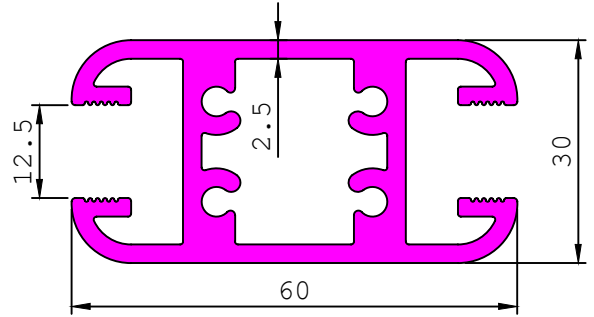

21675

0.766 kg/m

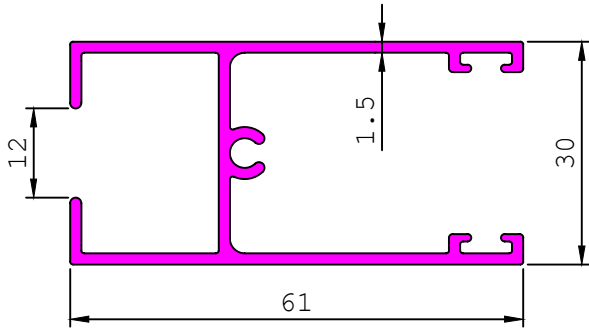

21414

0.705 kg/m

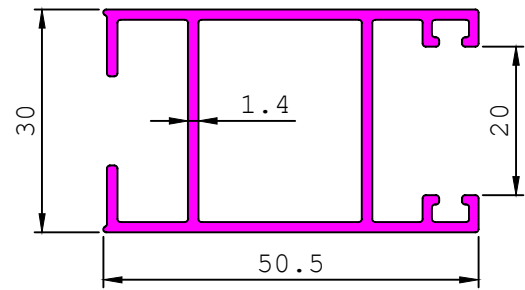

G100857

0.924 kg/m

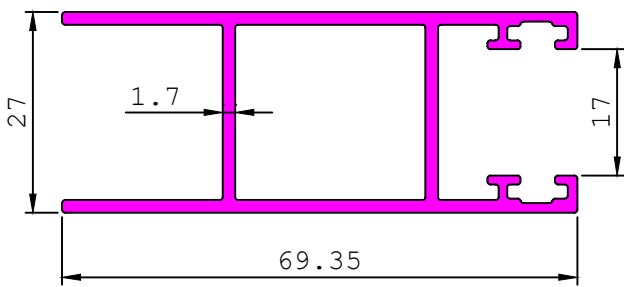

G100856

1.516 kg/m

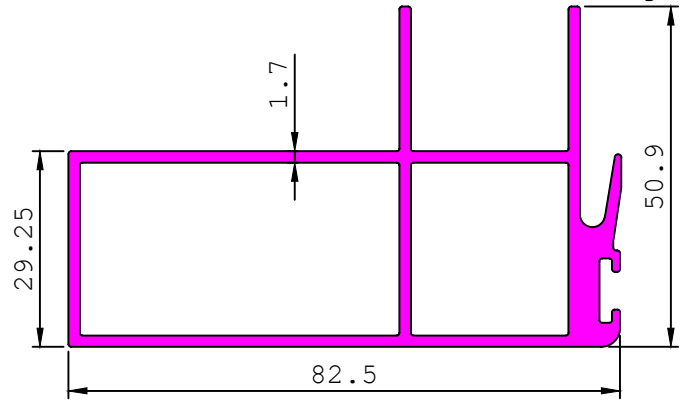

G100858

0.798 kg/m

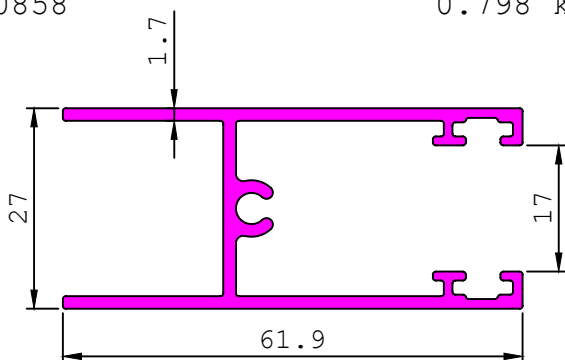

21543

0.699 kg/m

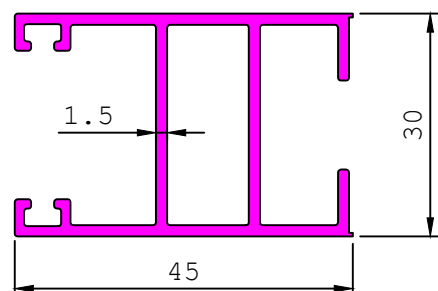

SLIDING WINDOW

INTERLOCK SECTION

(SERIES -30 mm.)

20550 0.994 kg/m

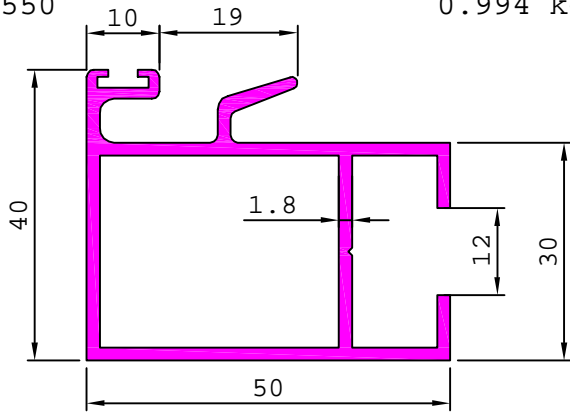

20555 0.869 kg/m

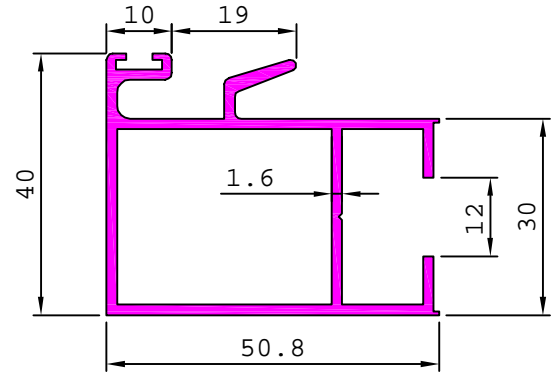

21009 0.964 kg/m

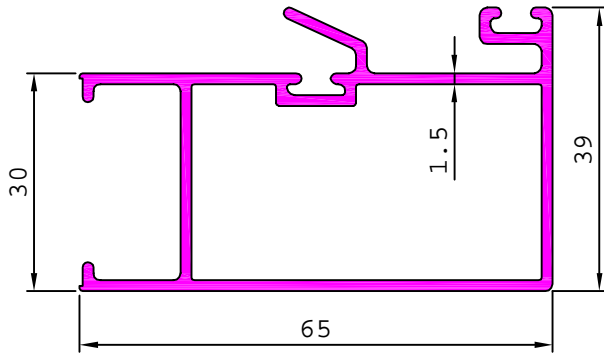

21397 0.646 kg/m

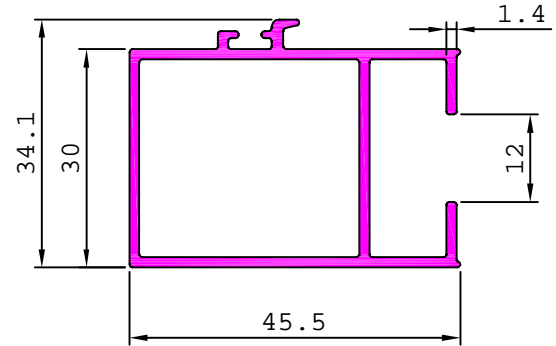

21344 0.938 kg/m

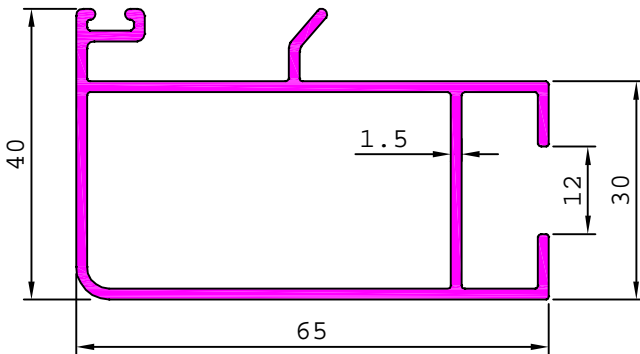

21592 0.925 kg/m

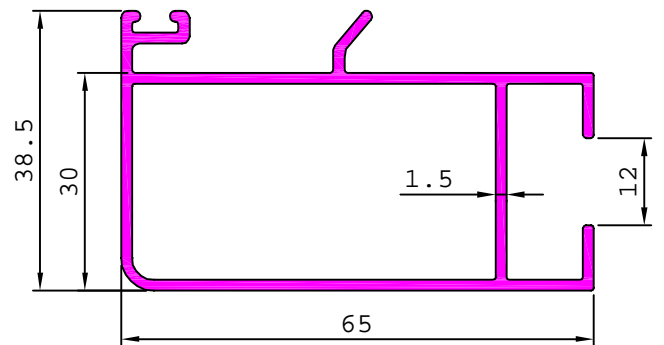

21798 1.497 kg/m

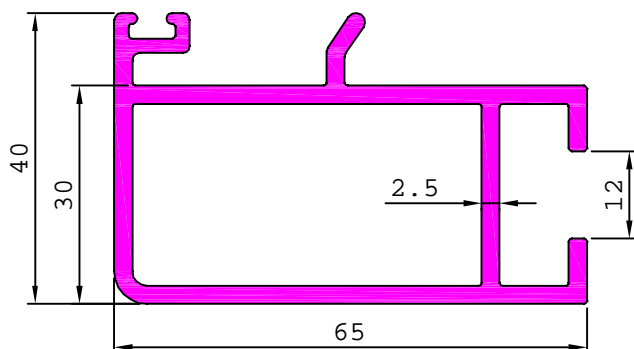

21717 0.933 kg/m

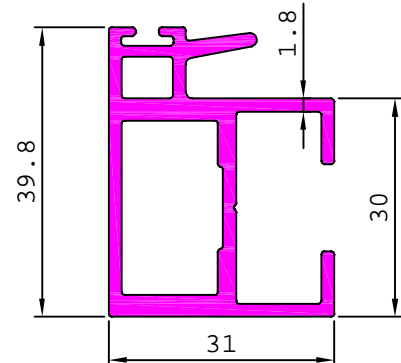

SLIDING WINDOW

INTERLOCK SECTION

(SERIES -30 mm.)

21743

0.999 kg/m

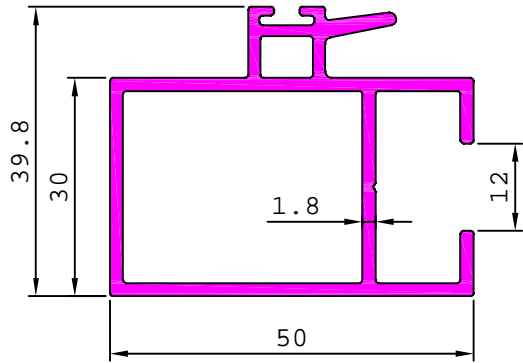

21742

1.121 kg/m

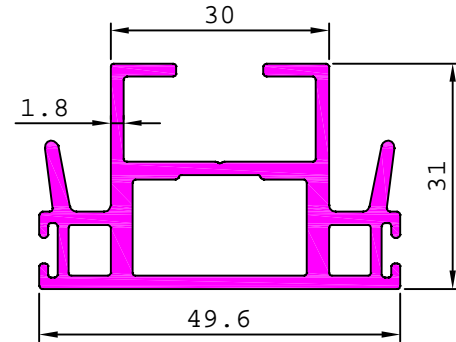

G101540

0.763 kg/m

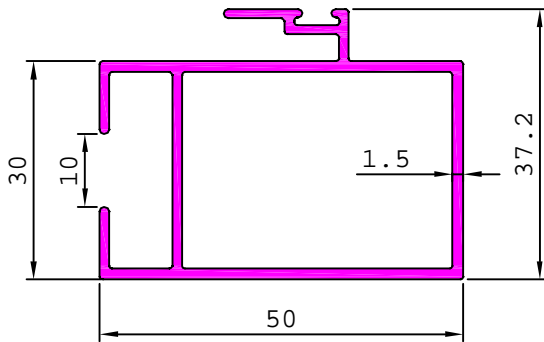

TRACK SECTION

SLIDING WINDOW

(SERIES -30 mm.)

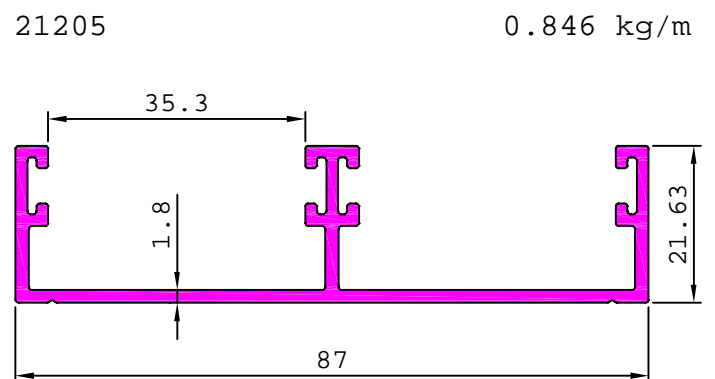
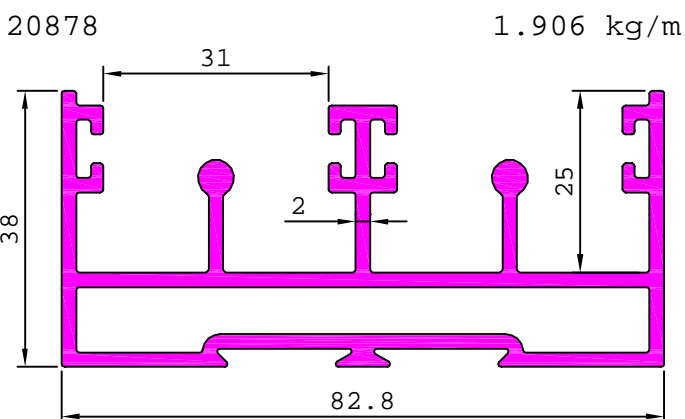
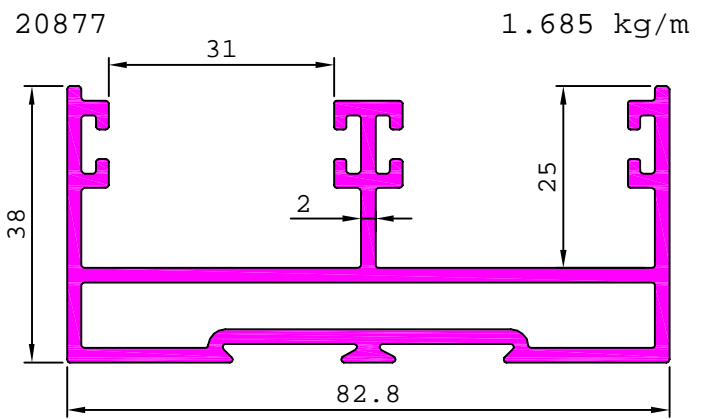
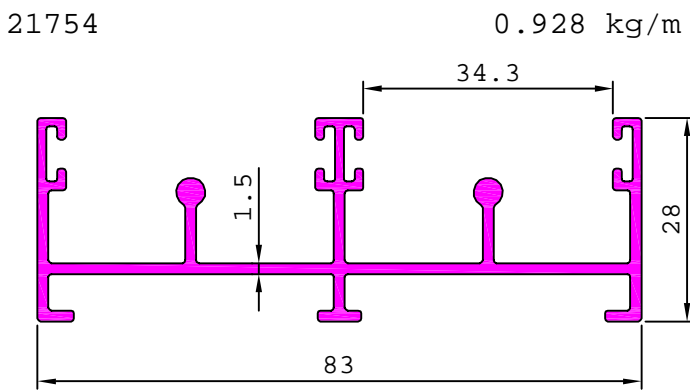
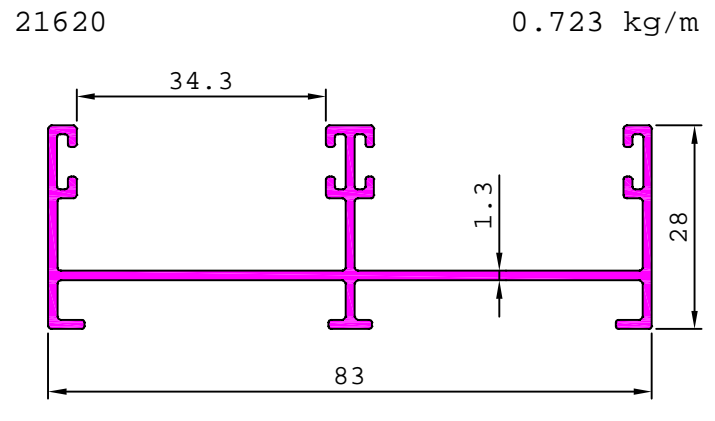
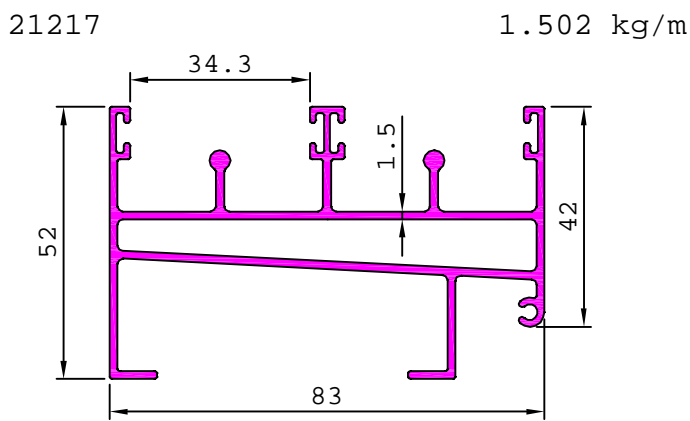
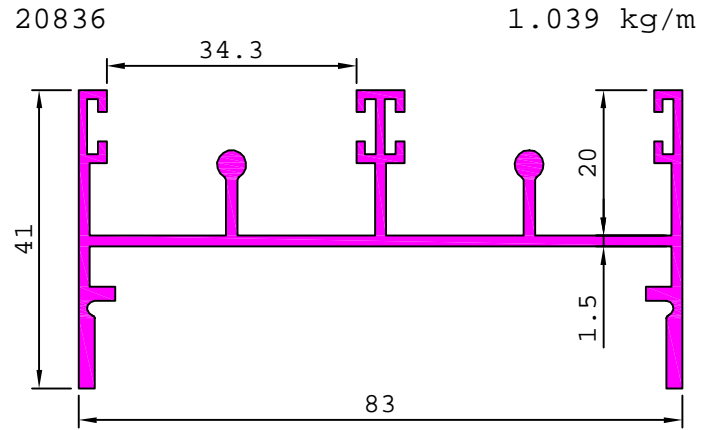
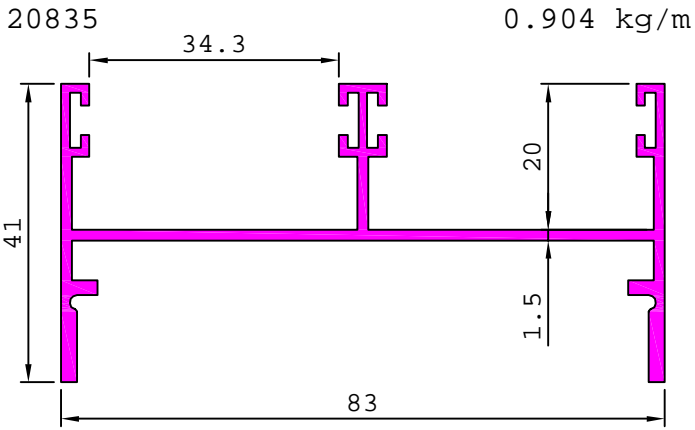

TRACK SECTION

SLIDING WINDOW

(SERIES -30 mm.)

21247

1.745 kg/m

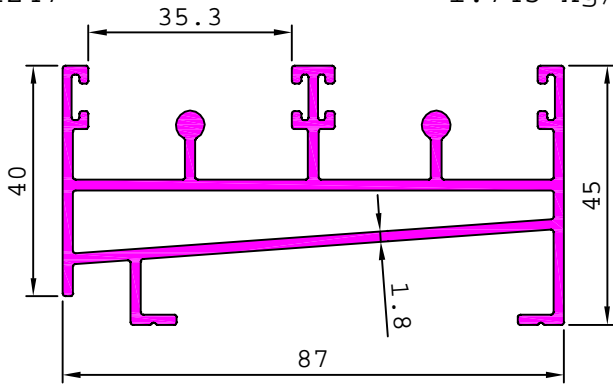

20659

1.278 kg/m

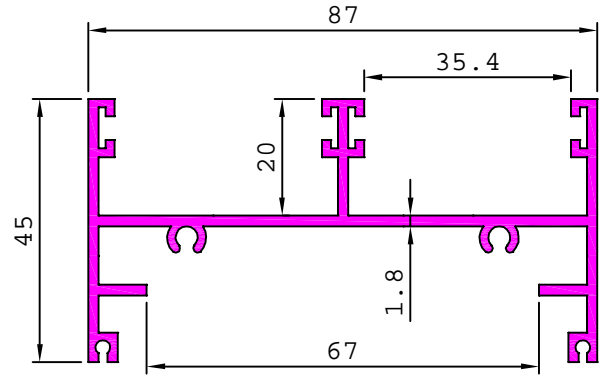

20660

1.709 kg/m

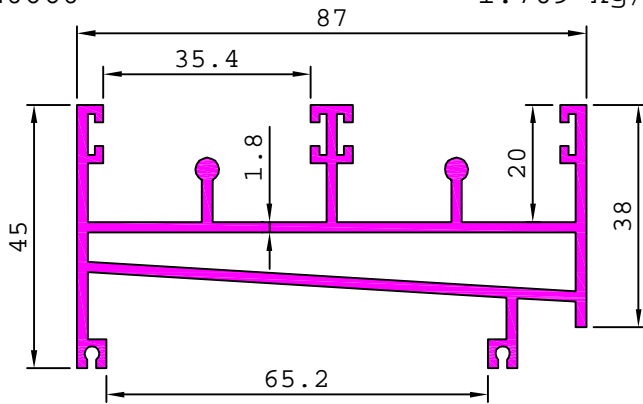

TRACK SECTION

SLIDING WINDOW

(SERIES -30 mm.)

20837

1.197 kg/m

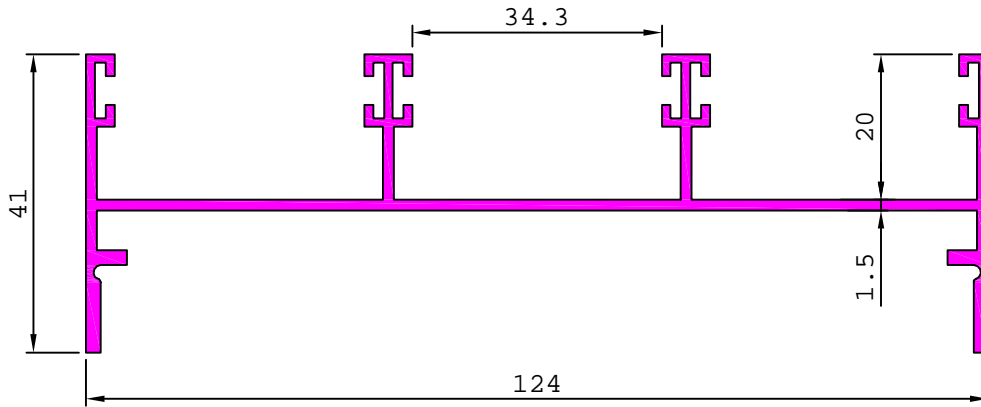

20838

1.518 kg/m

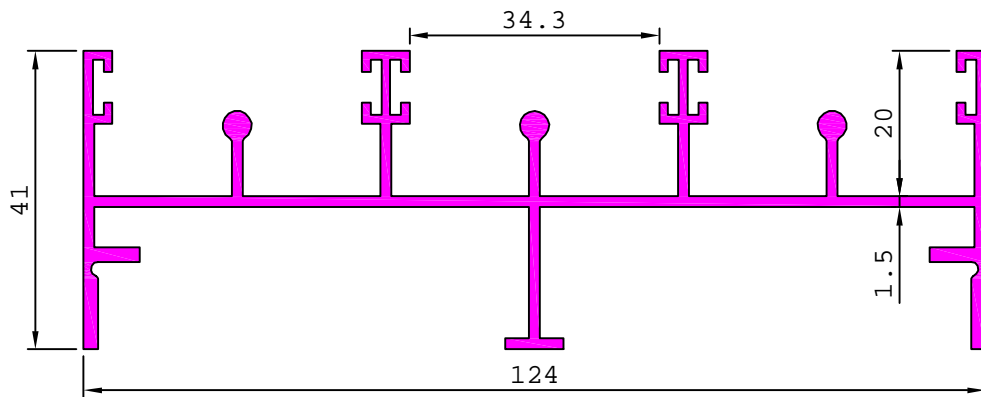

20928

2.032 kg/m

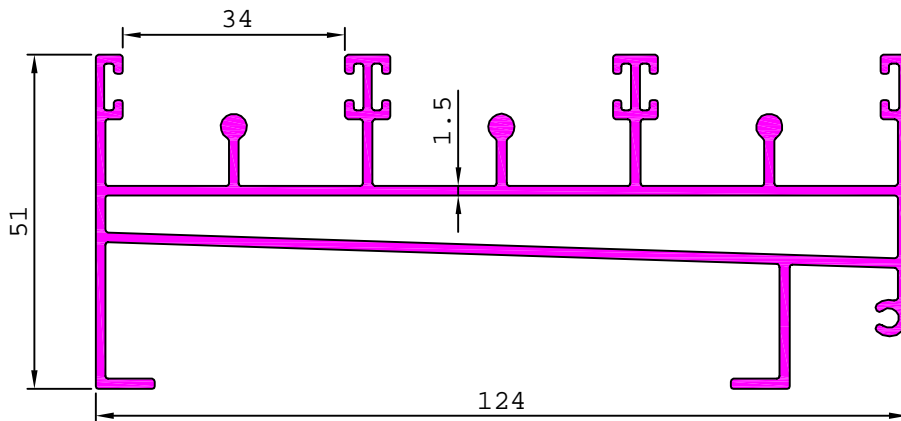

S4455

1.307 kg/m

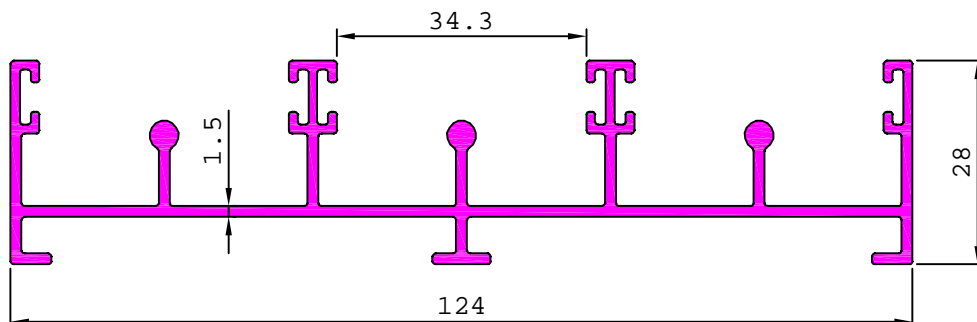

TRACK SECTION SLIDING WINDOW (SERIES -30 mm.)

21203

2.073 kg/m

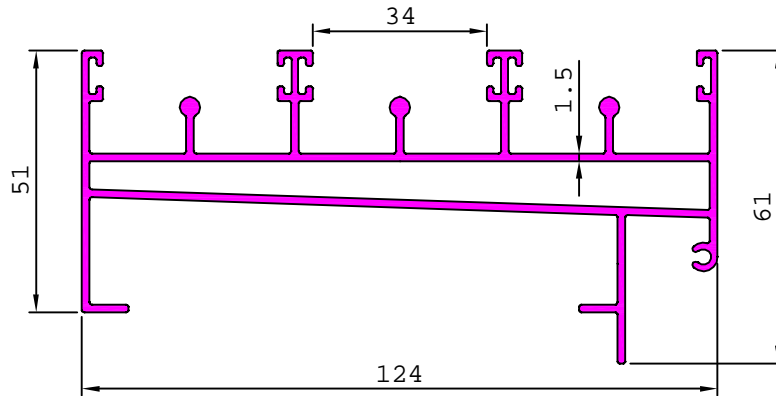

21621

1.007 kg/m

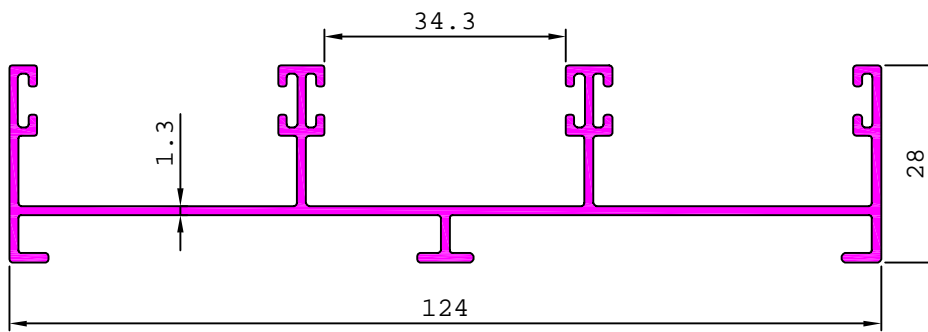

21831

1.163 kg/m

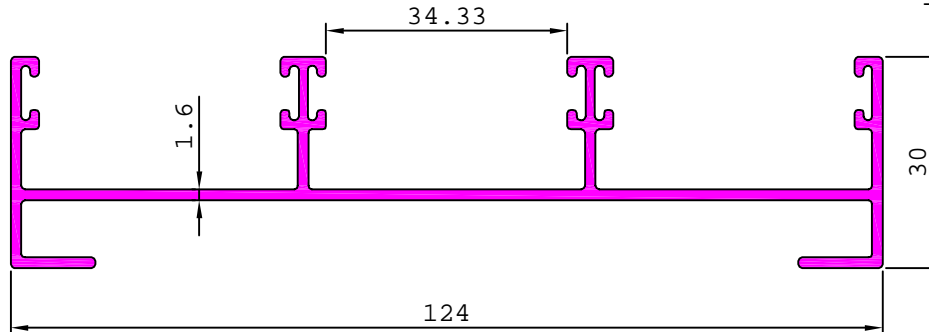

21738

1.262 kg/m

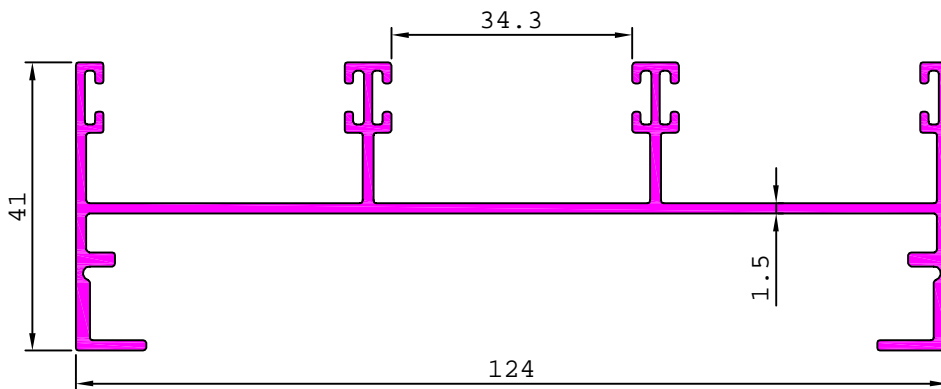

TRACK SECTION

SLIDING WINDOW

(SERIES -30 mm.)

21843

1.923 kg/m

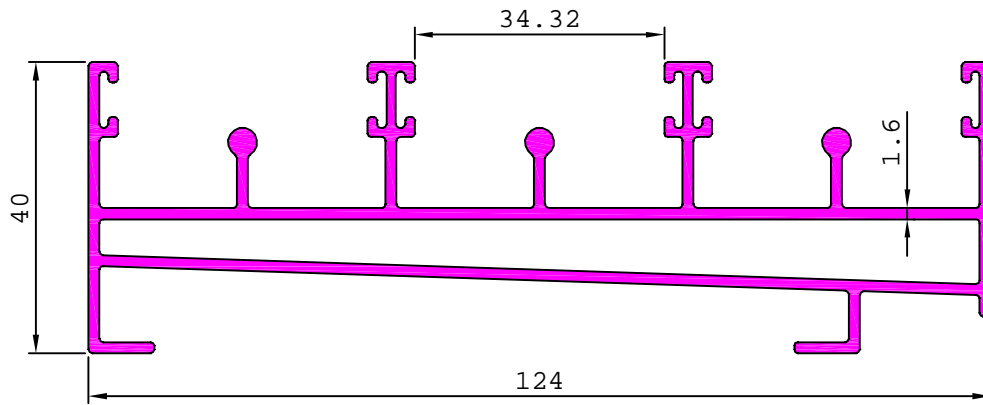

TRACK SECTION

SLIDING WINDOW

(SERIES -30 mm.)

20631

1.613 kg/m

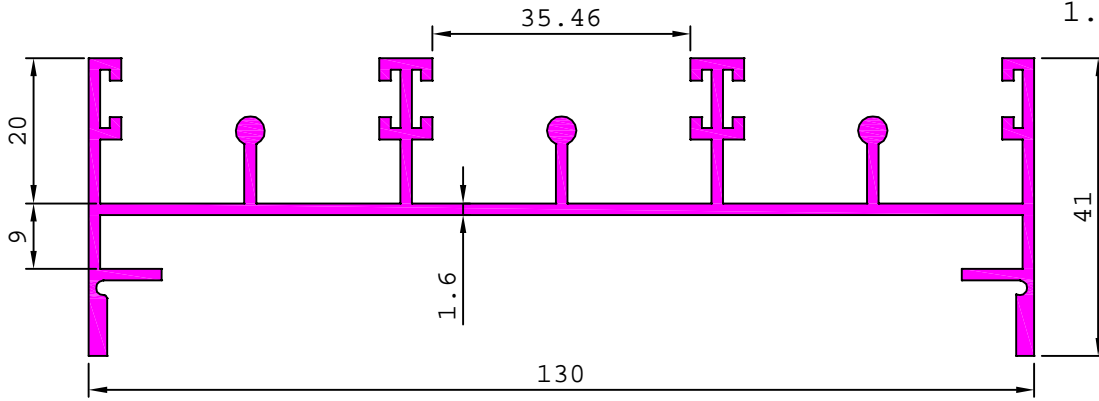

20632

1.408 kg/m

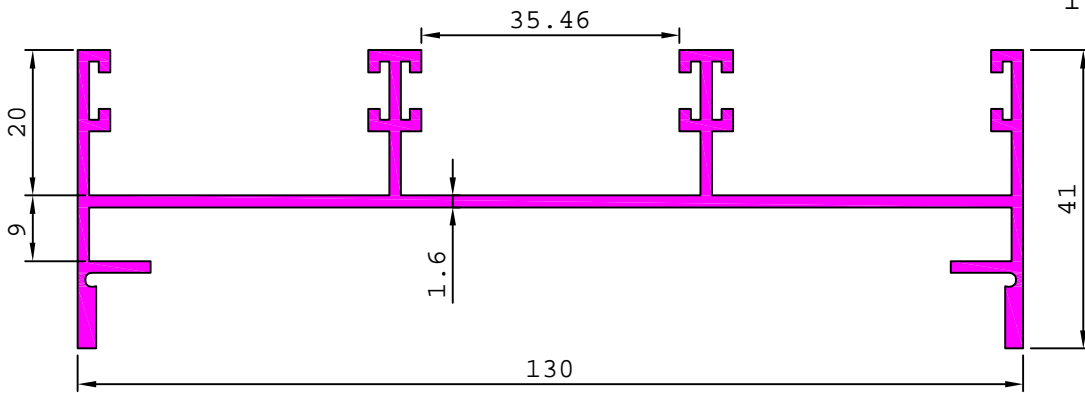

21206

1.223 kg/m

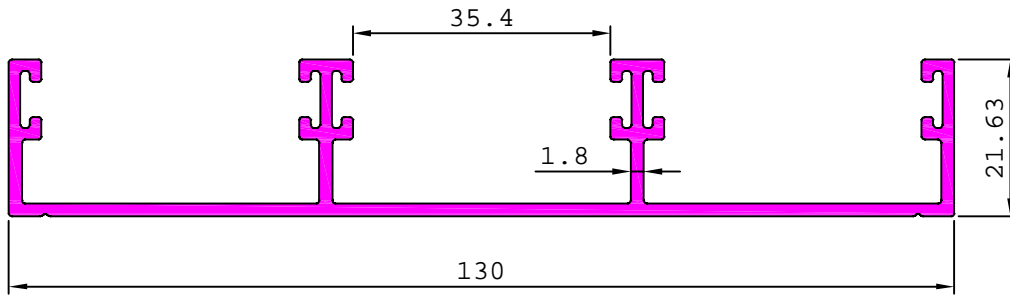

21243

2.586 kg/m

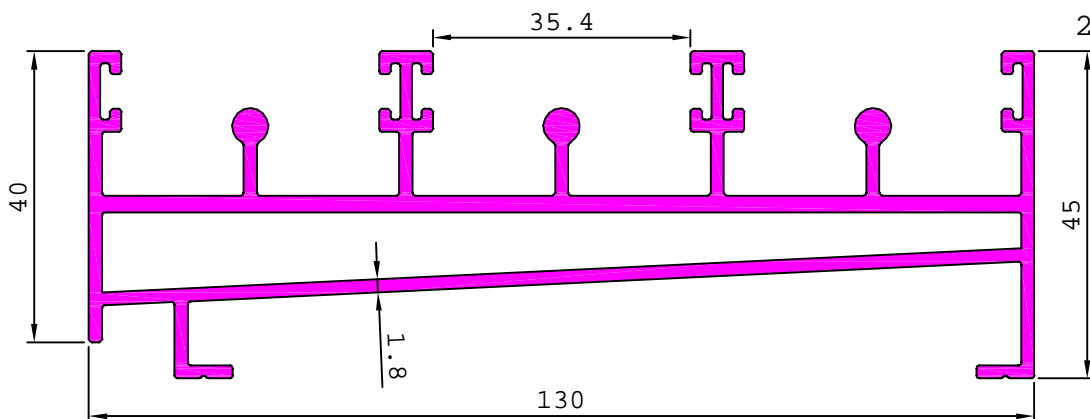

TRACK SECTION SLIDING WINDOW (SERIES -30 mm.)

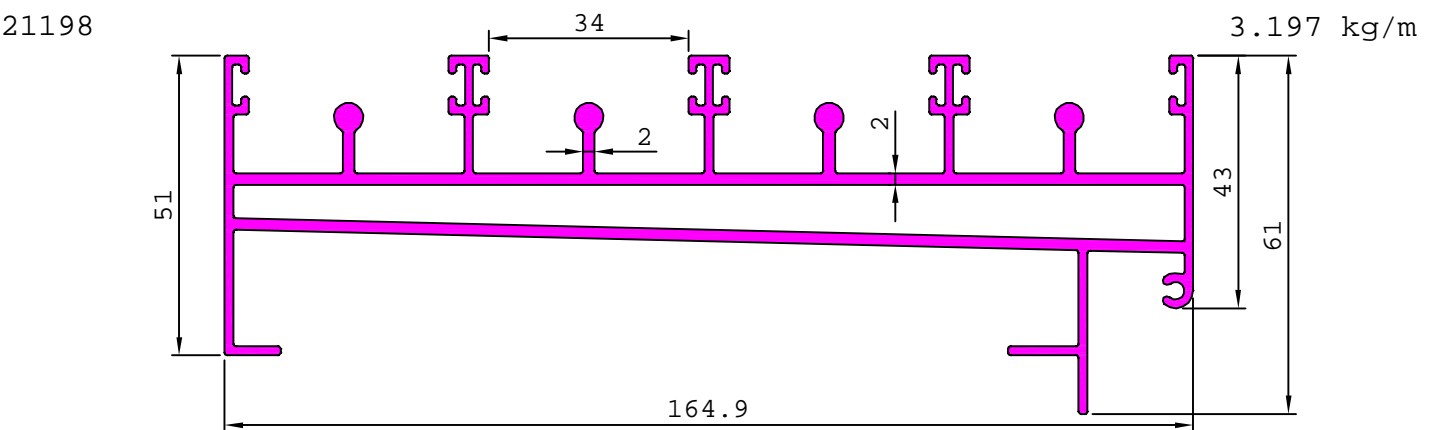
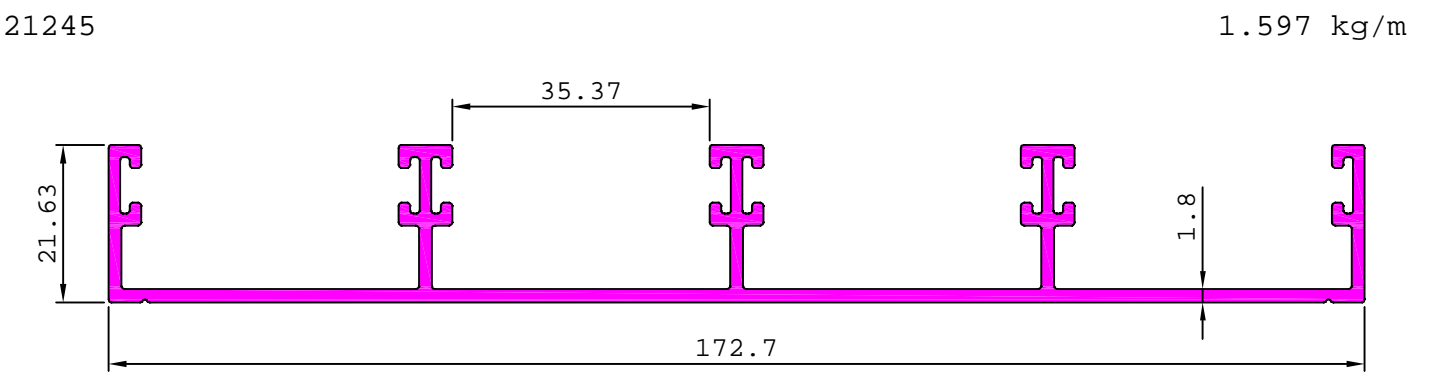
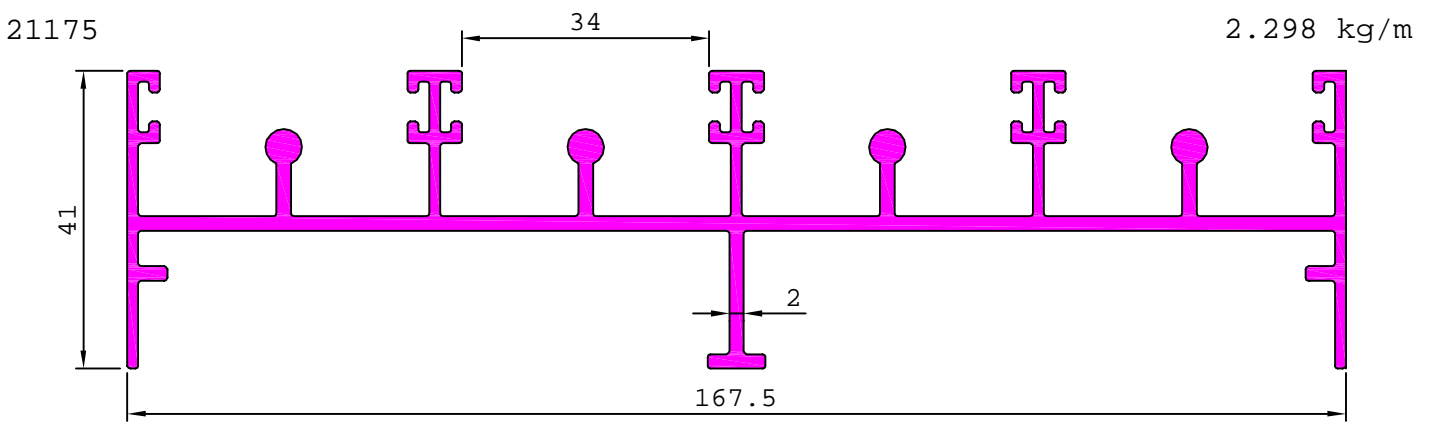
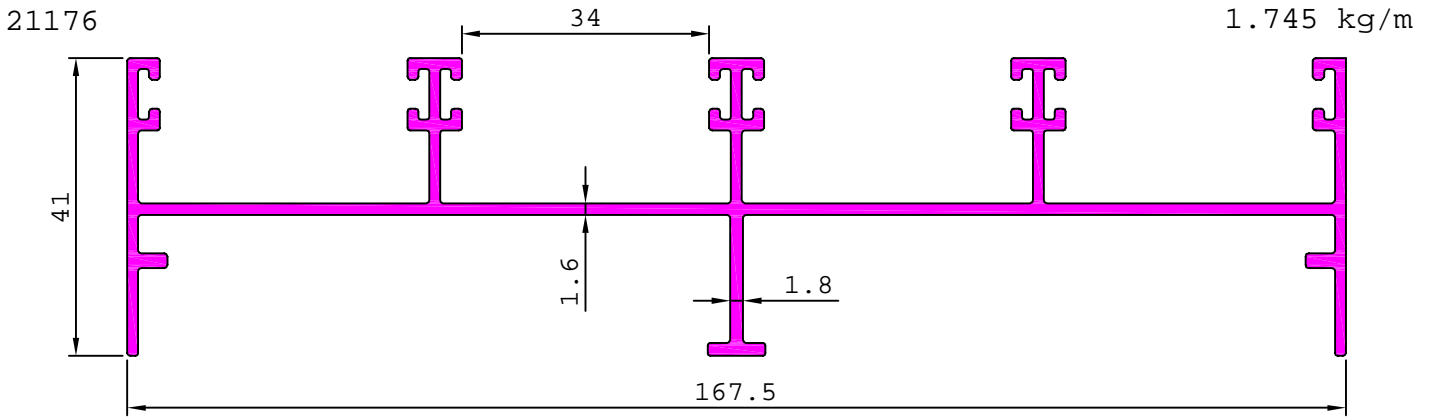

TRACK SECTION **SLIDING WINDOW** (SERIES -30 mm.)

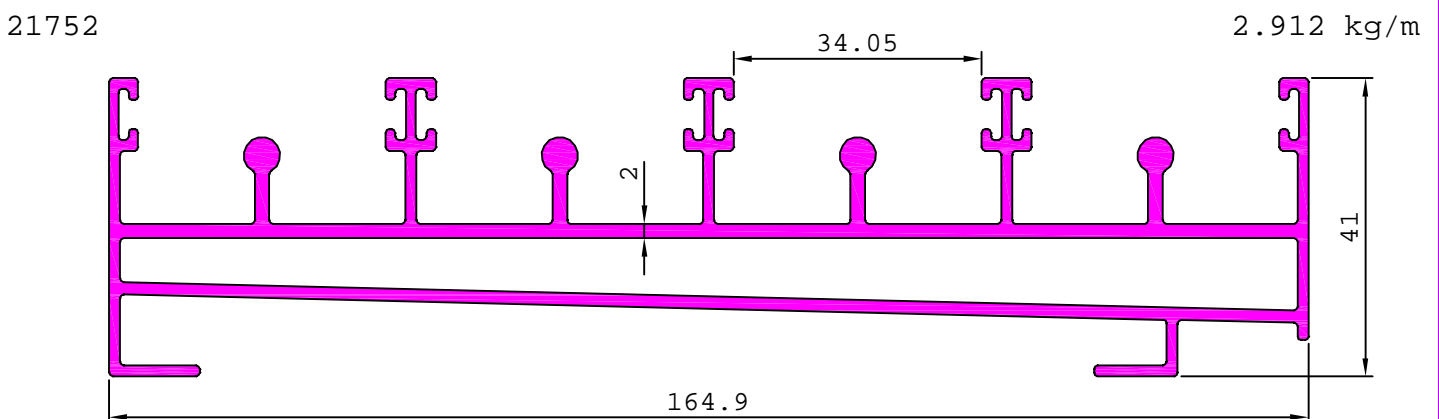
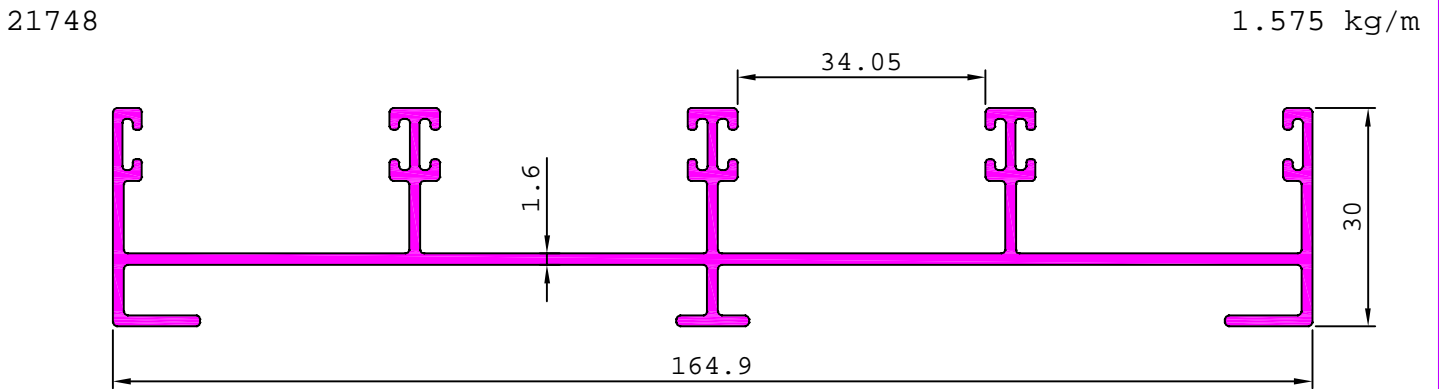
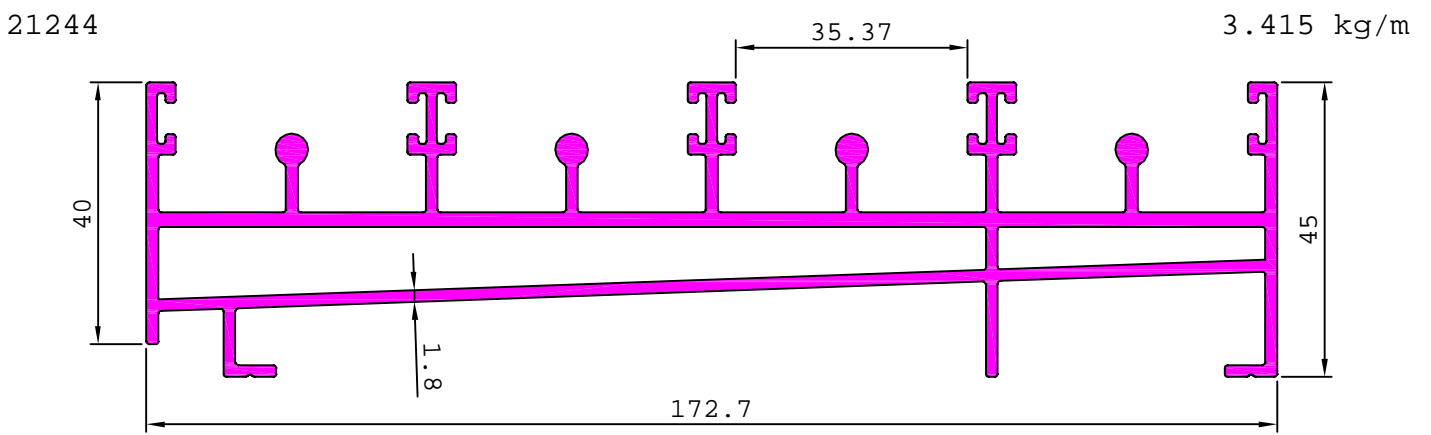
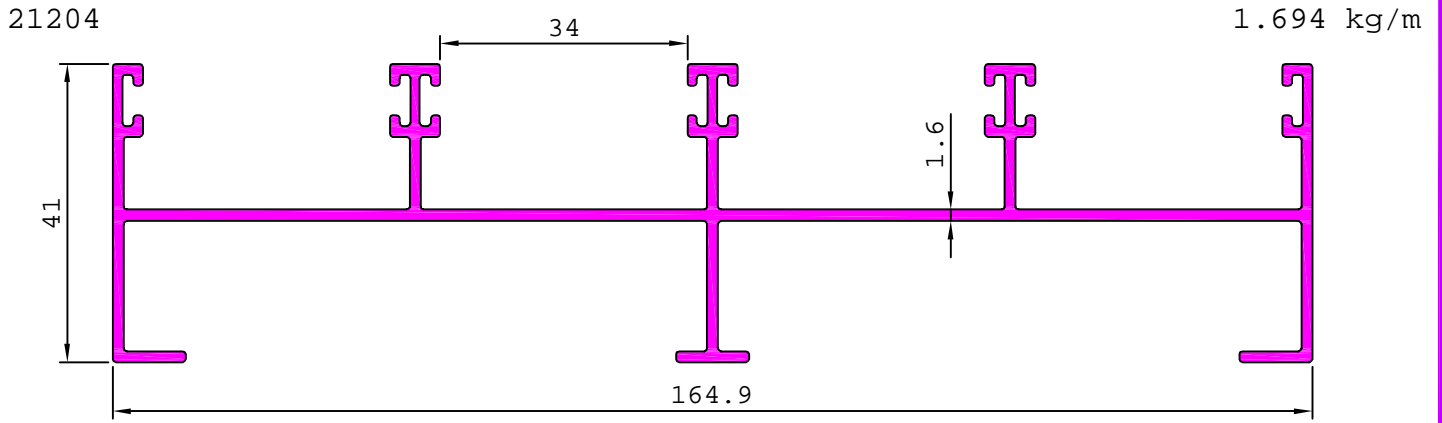

SHUTTER SECTION SLIDING WINDOW (SERIES -35 mm.)

21773

0.890 kg/m

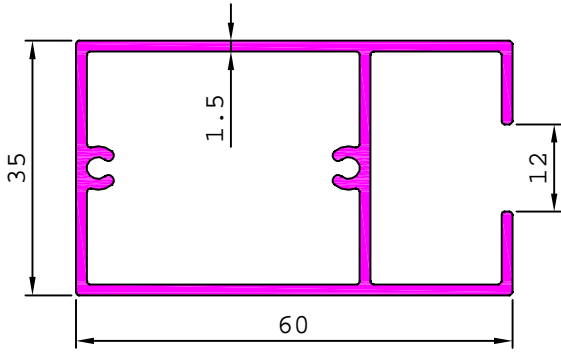

21775

0.938 kg/m

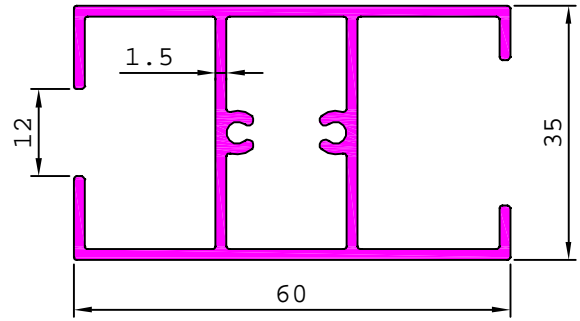

20788

1.005 kg/m

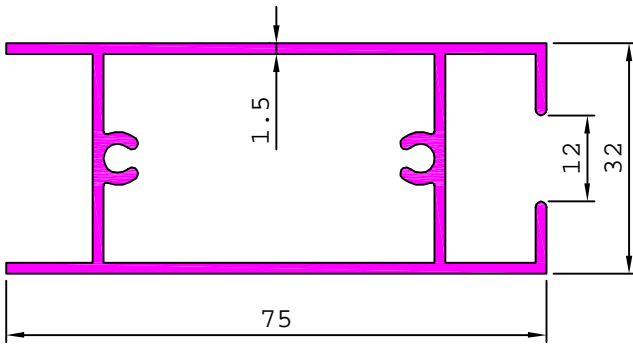

21996

1.206 kg/m

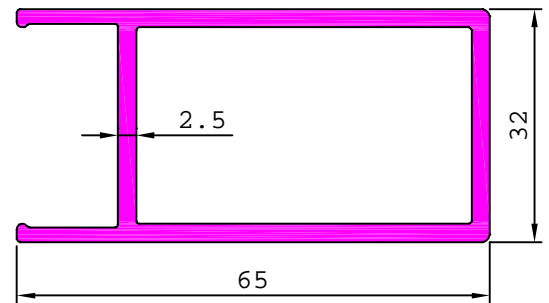

21997

1.501 kg/m

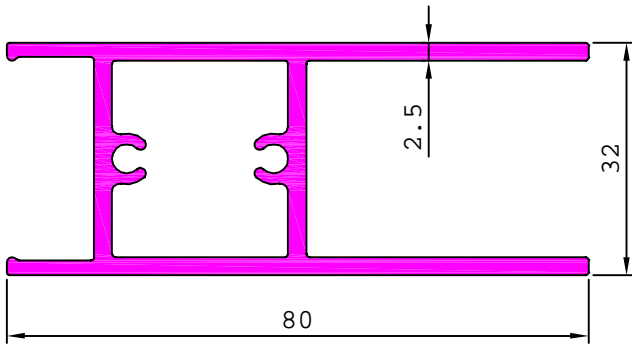

21774

1.026 kg/m

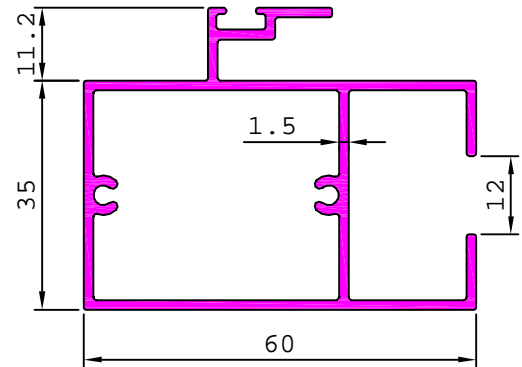

21788

1.162 kg/m

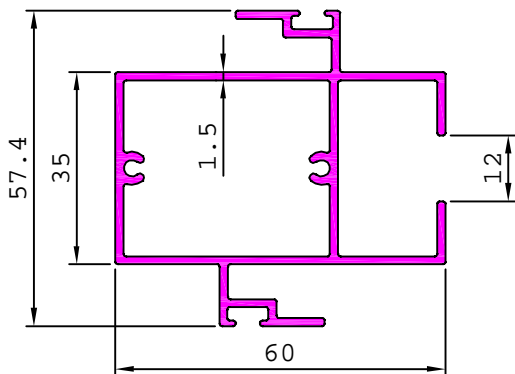

21789

1.026 kg/m

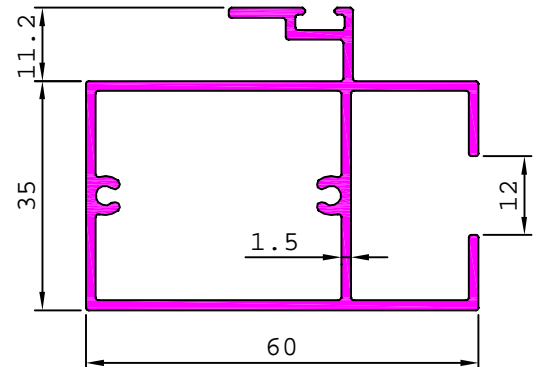

SLIDING WINDOW

INTERLOCK SECTION

(SERIES -35 mm.)

G100795

0.636 kg/m

21995

1.441 kg/m

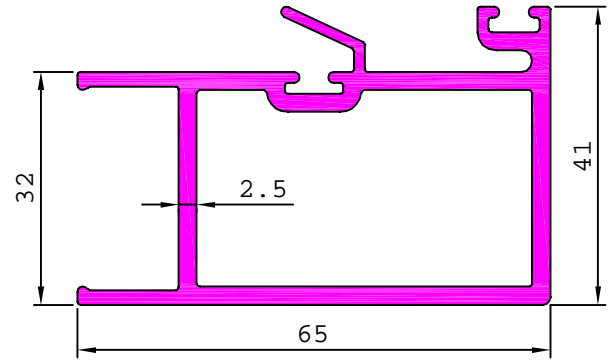
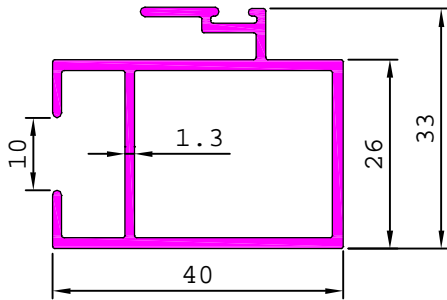

G100853

0.862 kg/m

G101397

0.548 kg/m

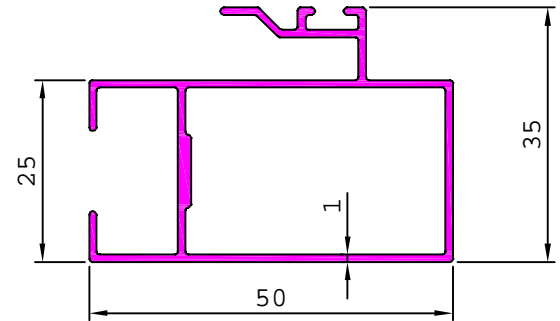
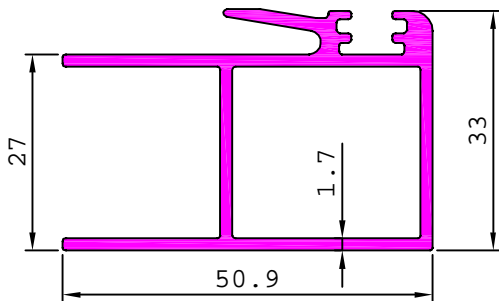

SLIDING WINDOW

(SERIES -35 mm.)

21771

1.640 kg/m

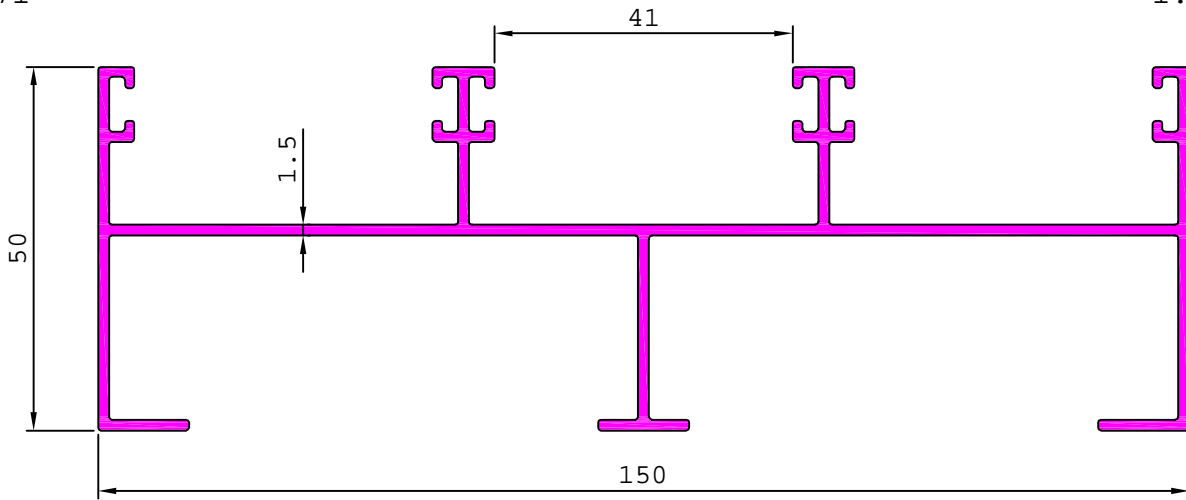

21772

1.852 kg/m

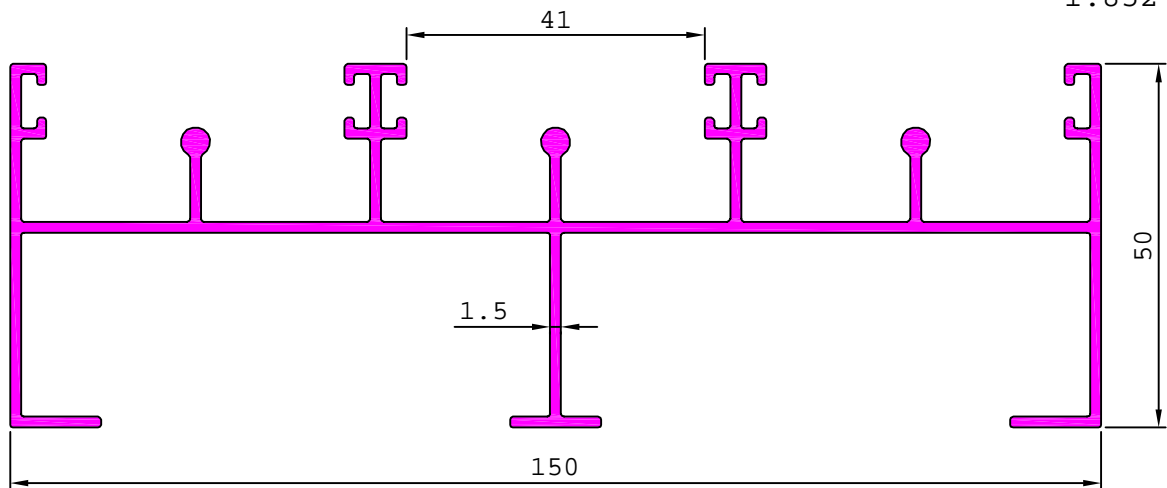

SLIDING WINDOW

(SERIES -40 mm.)

21124

2.314 kg/m

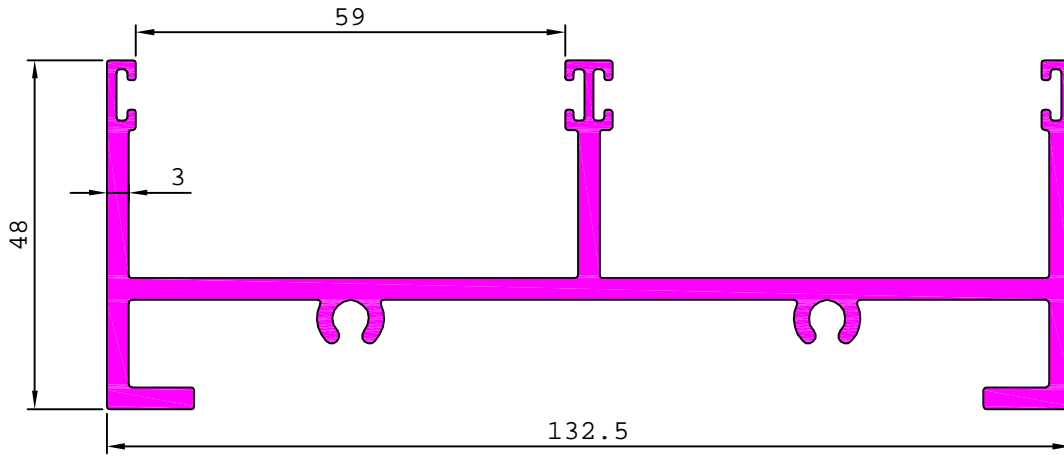

SLIDING WINDOW

(SERIES -60 mm.)

21266

3.652 kg/m

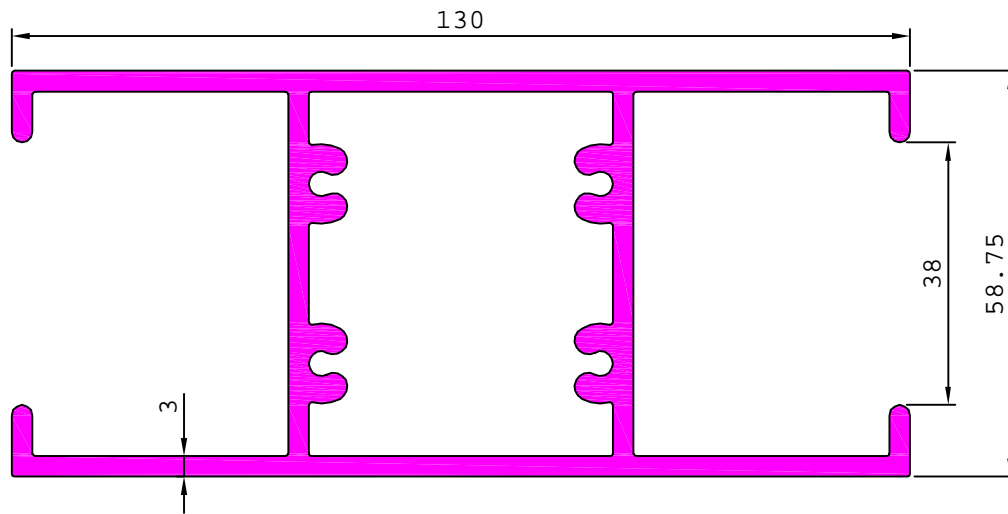

21265

2.815 kg/m

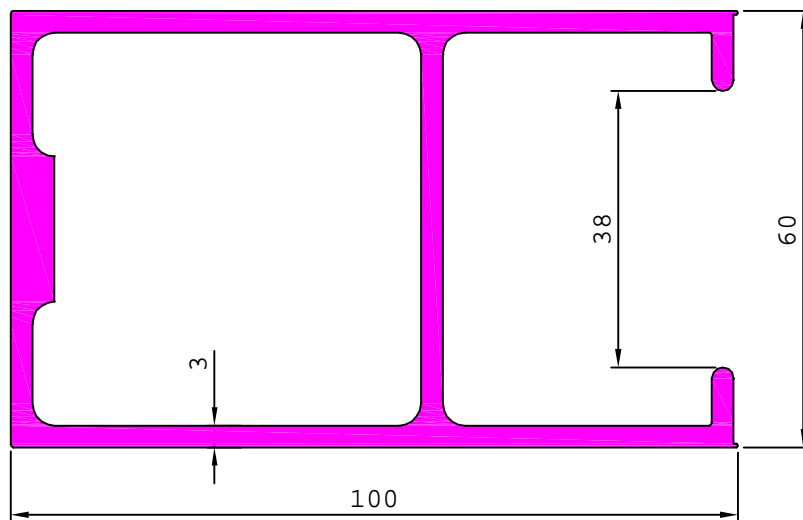

21258

3.185 kg/m

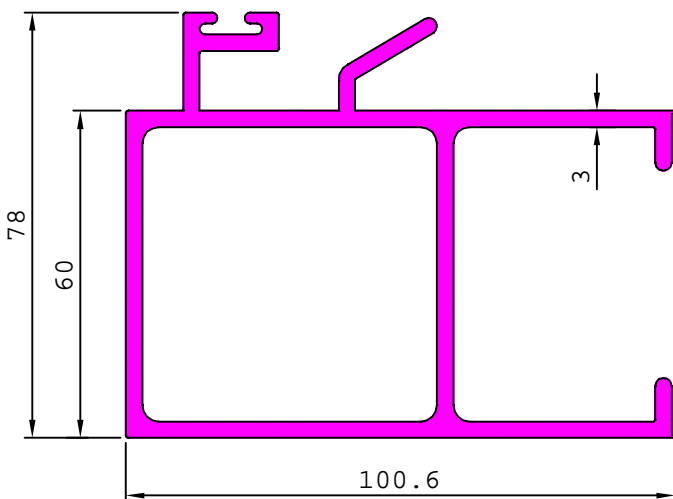

SLIDING WINDOW

(SERIES -60 mm.)

21267

3.642 kg/m

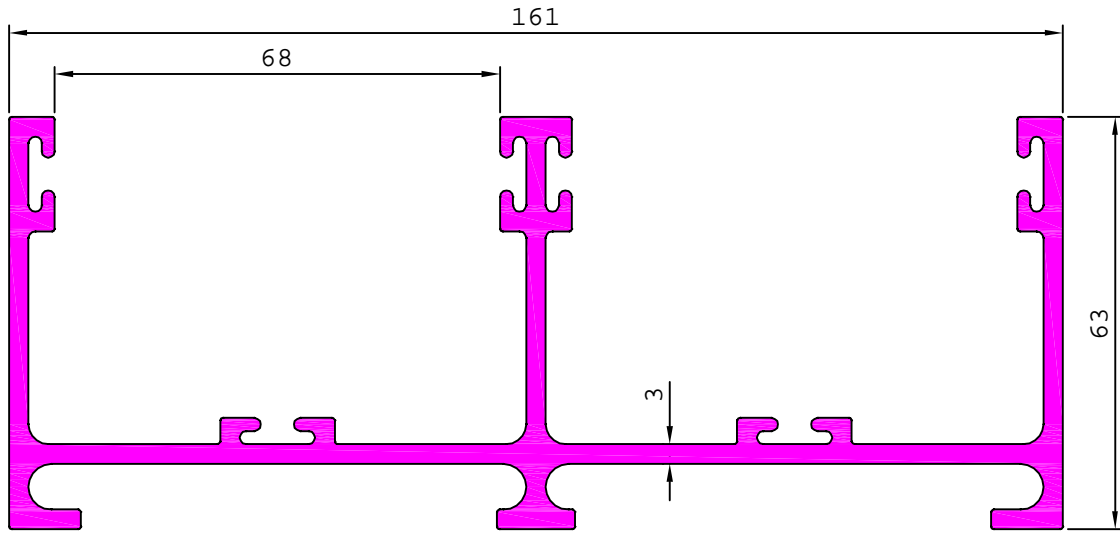

21268

6.662 kg/m

