

## CURTAIN WALL SECTION

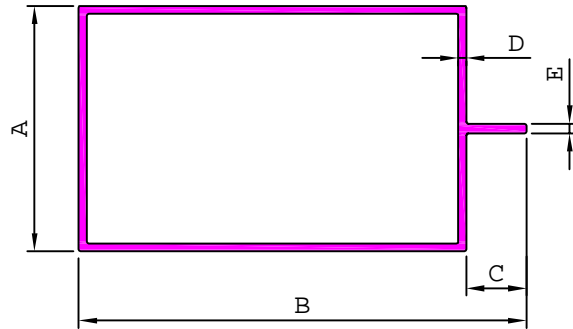

SL. No.	Section No.	A	B	C	D	E	Weight kg/m
1	<b>35587</b>	50.00	55.00	5.00	1.40	1.40	0.754
2	<b>35984</b>	50.00	55.00	5.00	3.00	3.00	1.564
3	<b>36145</b>	50.00	56.00	6.00	1.80	4.00	1.002
4	<b>S5519</b>	50.00	86.00	6.00	1.80	4.00	1.293
5	<b>35551</b>	50.00	86.00	6.00	1.90	1.80	1.324
6	<b>35544</b>	50.00	86.00	6.00	2.85	1.80	1.942
7	<b>35862</b>	50.00	86.00	6.00	3.00	2.80	2.054
8	<b>35548</b>	50.00	86.50	26.50	3.00	2.00	1.498
9	<b>22776</b>	50.00	160.00	10.00	2.00	2.00	2.171
10	<b>22785</b>	50.00	175.00	25.00	2.00	2.00	2.252
11	<b>S4206</b>	50.00	190.00	10.00	3.00	5.00	3.764
12	<b>35871</b>	51.00	85.50	5.00	1.64	1.95	1.162
13	<b>22753</b>	51.00	93.00	12.50	1.64	1.95	1.201
14	<b>22764</b>	55.00	112.00	12.00	2.00	2.00	1.696
15	<b>35512</b>	57.00	91.50	28.00	2.25	6.00	1.863
16	<b>35648</b>	57.00	150.00	10.00	3.00	5.00	2.506
16	<b>35586</b>	58.00	69.00	5.00	1.40	1.40	0.920
17	<b>35565</b>	63.50	134.30	20.00	2.50	3.00	2.494
18	<b>35752</b>	67.00	74.00	24.00	1.50	3.00	1.119
19	<b>35750</b>	67.00	160.16	24.00	2.00	3.00	2.346

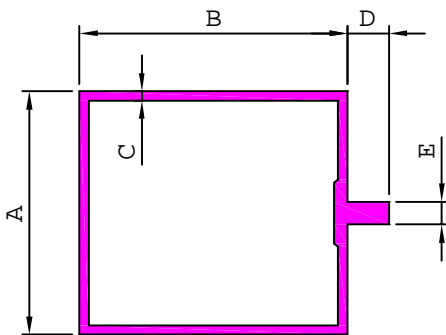

SL. No.	Section No.	A	B	C	D	E	Weight kg/m
1	<b>29231</b>	58.00	64.00	1.50	10.00	3.00	1.081
2	<b>22796</b>	58.00	64.00	1.63	5.00	5.00	1.126
3	<b>35704</b>	58.00	64.00	1.70	5.00	5.00	1.197
4	<b>22735</b>	58.00	64.00	1.70	10.00	5.00	1.264
5	<b>22716</b>	58.00	64.00	2.00	10.00	5.00	1.450
6	<b>22719</b>	63.50	63.50	2.50	5.00	5.00	1.755
7	<b>22718</b>	63.50	114.30	2.50	5.00	5.00	2.440

## CURTAIN WALL SECTION

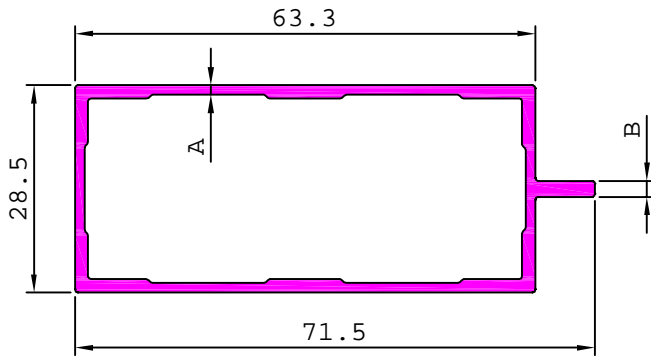

SL. No.	Section No.	A	B	Weight kg/m
1	<b>35861</b>	0.80	1.10	0.484
2	<b>22786</b>	1.10	1.40	0.634
3	<b>22768</b>	1.32	2.20	0.796

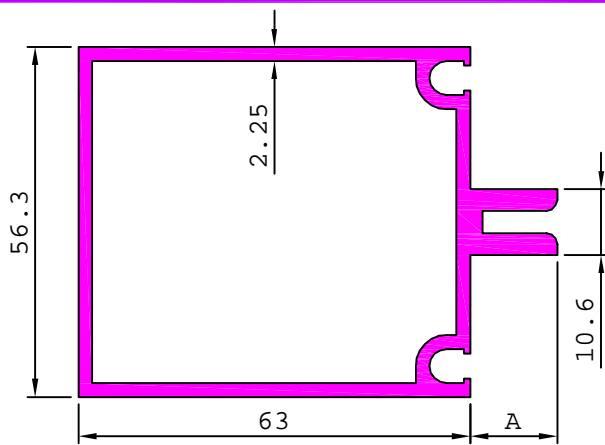

SL. No.	Section No.	A	Weight kg/m
1	<b>22703</b>	14.00	1.751
2	<b>22741</b>	18.00	1.869

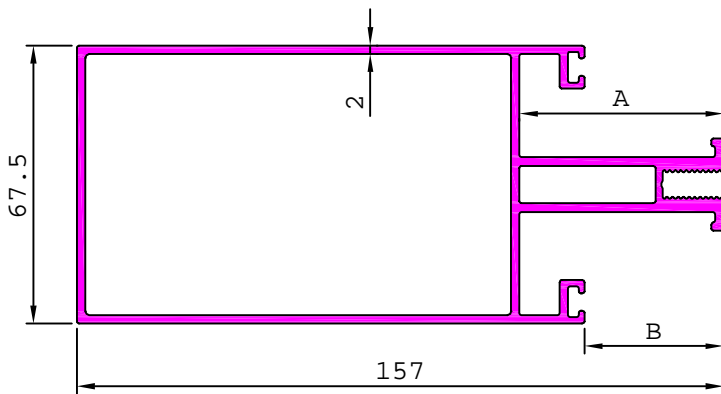

SL. No.	Section No.	A	B	Weight kg/m
1	<b>35872</b>	49.55	33.80	2.952
2	<b>35873</b>	31.30	27.30	2.698

22783 0.957 kg/m

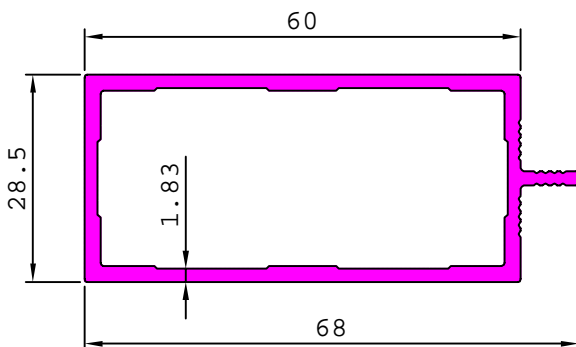

## CURTAIN WALL SECTION

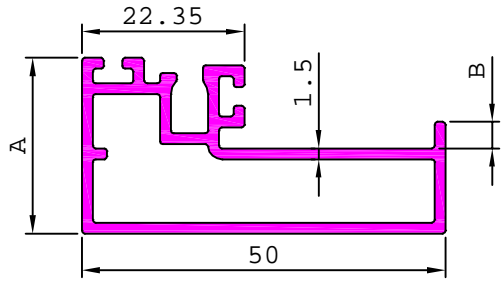

SL. No.	Section No.	A	B	Weight kg/m
1	<b>35780</b>	24.15	3.65	0.703
2	<b>35847</b>	31.65	6.15	0.774

S6543

0.879 kg/m

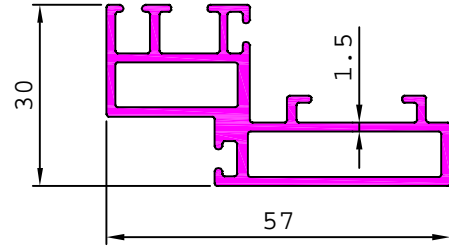

21391

0.906 kg/m

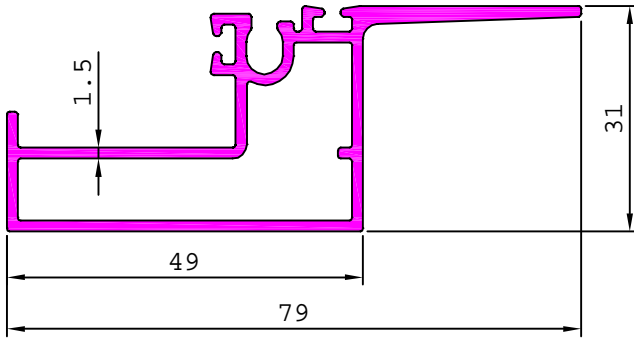

21392

0.955 kg/m

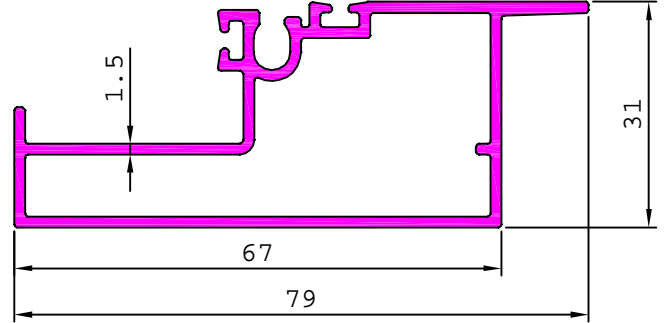

29157

0.783 kg/m

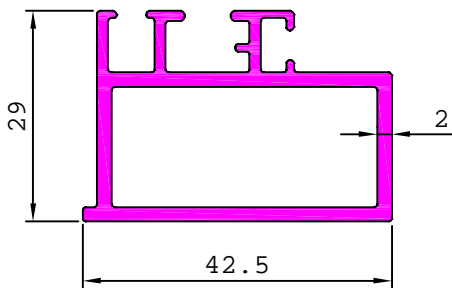

35509

1.021 kg/m

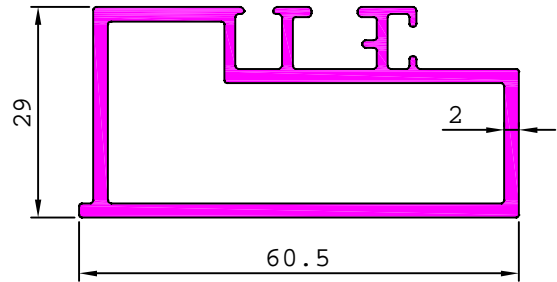

35580

0.545 kg/m

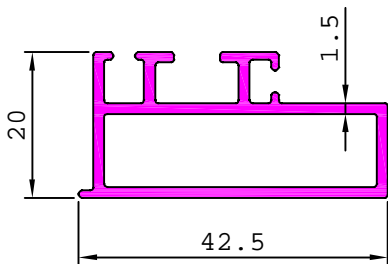

35662

0.715 kg/m

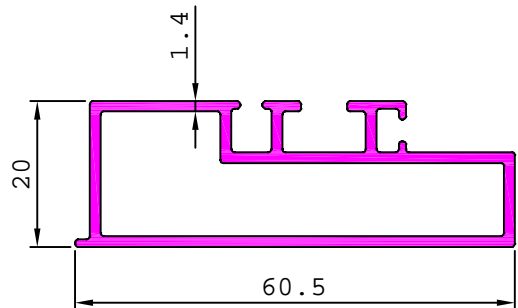

## CURTAIN WALL SECTION

35858

0.553 kg/m

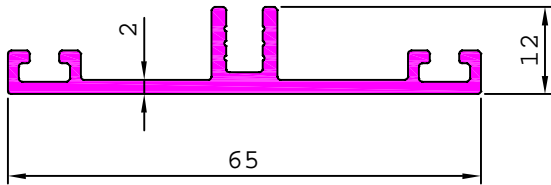

36149

1.607 kg/m

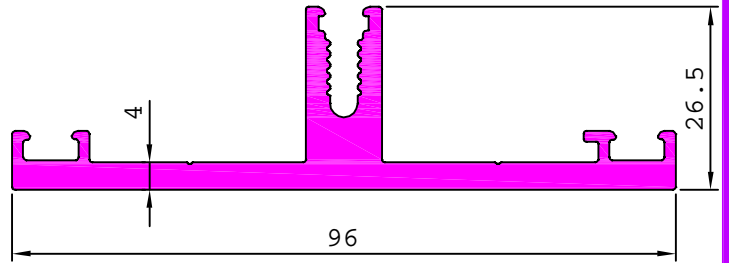

36186

0.715 kg/m

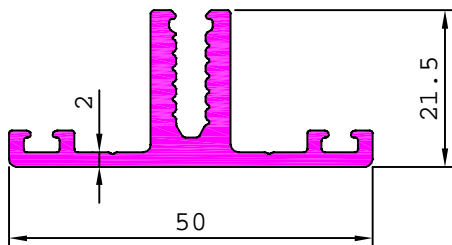

S6224

0.766 kg/m

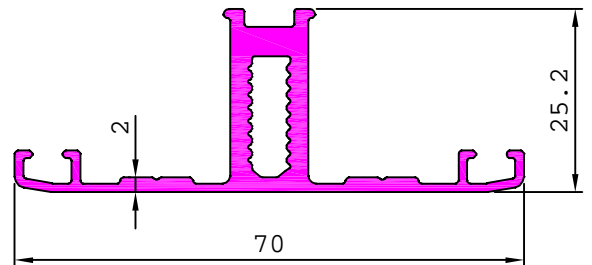

S6471

1.650 kg/m

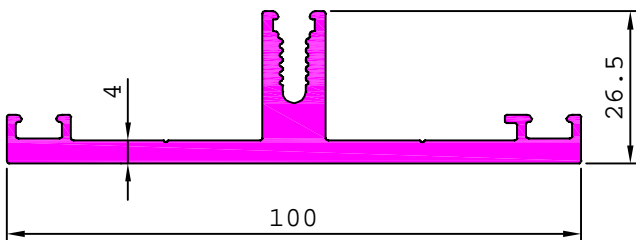

S6472

3.133 kg/m

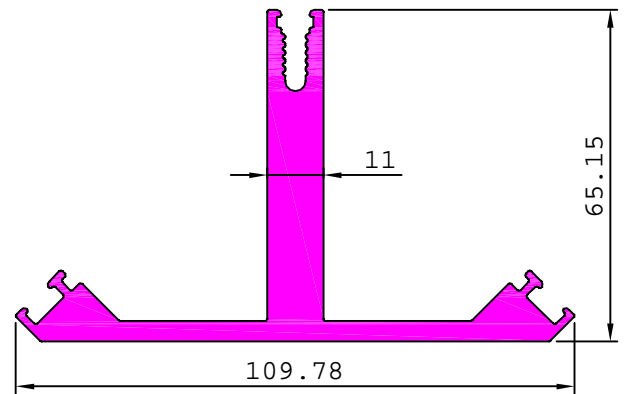

22770

1.391 kg/m

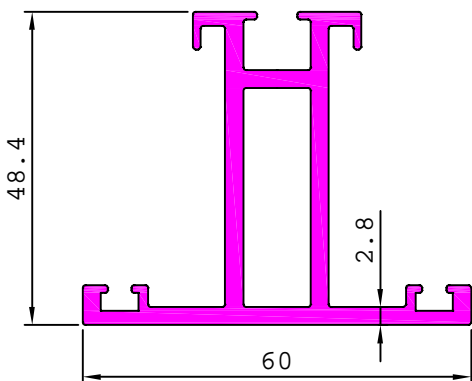

22893

0.900 kg/m

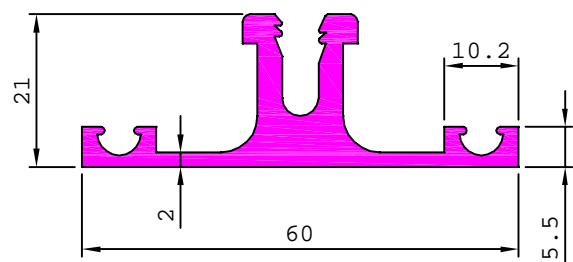

## CURTAIN WALL SECTION

22908

0.485 kg/m

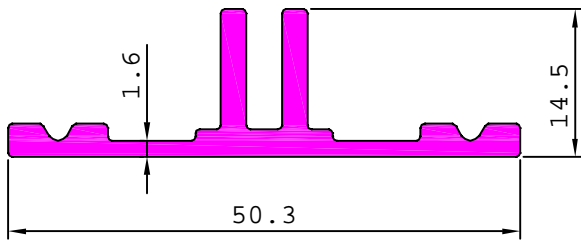

22909

0.326 kg/m

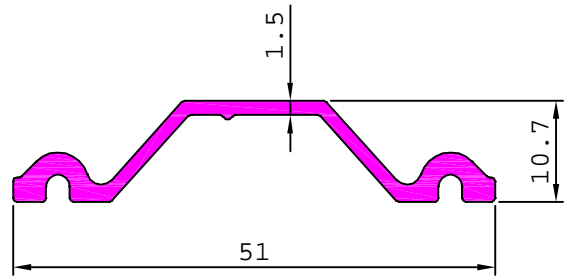

22892

0.480 kg/m

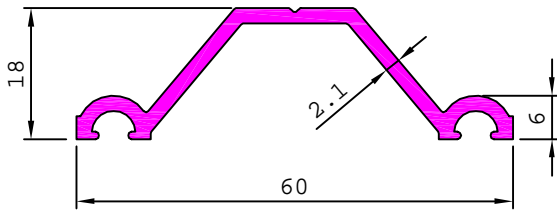

## CURTAIN WALL SECTION - 40 mm.

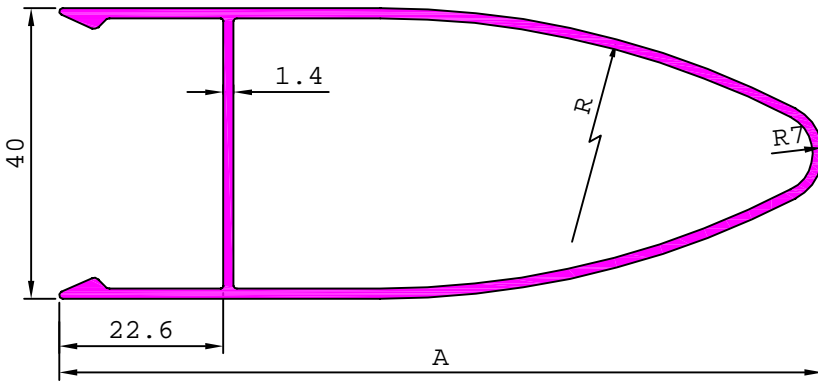

SL. No.	Section No.	A	R	Weight kg/m
1	<b>35810</b>	125.00	150.00	1.143
2	<b>35811</b>	105.00	125.00	0.994
3	<b>35812</b>	80.00	75.00	0.810

**MATCHING WITH 35817**

35817

0.449 kg/m

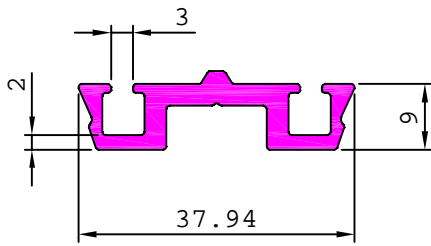

**MATCHING WITH 35810, 35811, 35812, 35816**

35816

0.271 kg/m

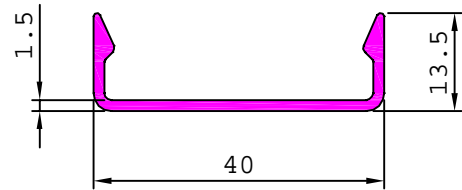

**MATCHING WITH 35817**

S6035

0.252 kg/m

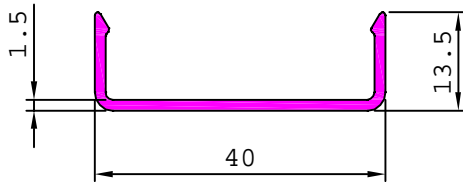

**MATCHING WITH S6036**

S6036

0.319 kg/m

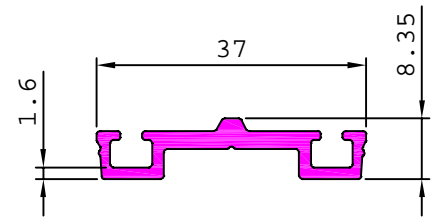

**MATCHING WITH S6035**

S6034

1.089 kg/m

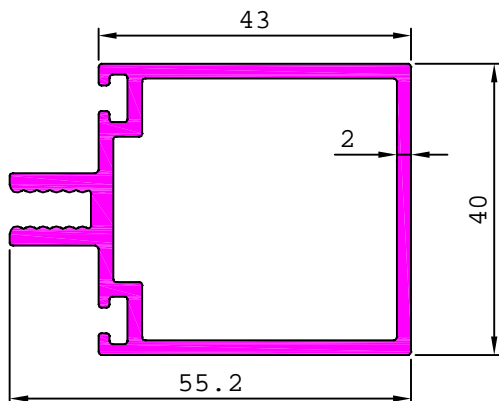

35814

0.918 kg/m

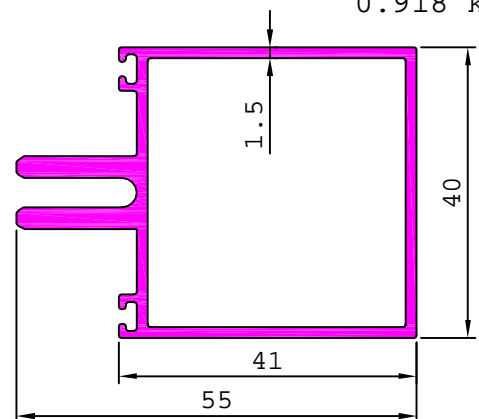

## CURTAIN WALL SECTION - 45 mm.

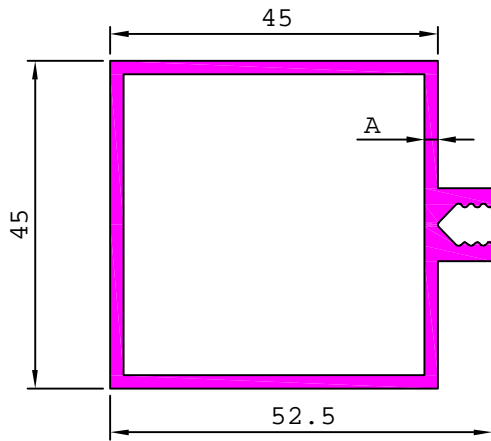

SL. No.	Section No.	A	Weight kg/m
1	<b>22754</b>	1.40	0.765
2	<b>22717</b>	1.80	0.951

22704

0.245 kg/m

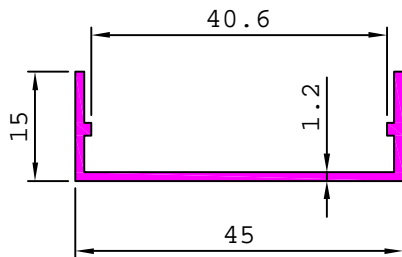

**MATCHING WITH 22706**

22706

0.529 kg/m

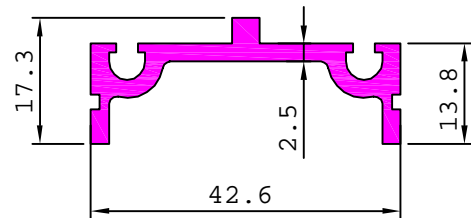

**MATCHING WITH 22704, 22769**

22769

0.243 kg/m

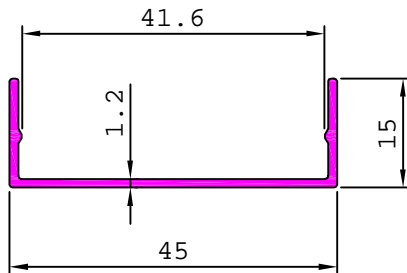

**MATCHING WITH 22779**

22779

0.387 kg/m

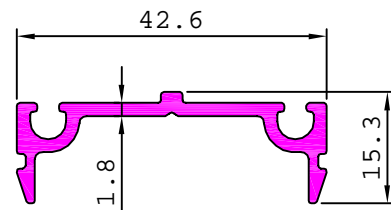

**MATCHING WITH 22769**

## CURTAIN WALL SECTION - 45 mm.

22705 1.915 kg/m

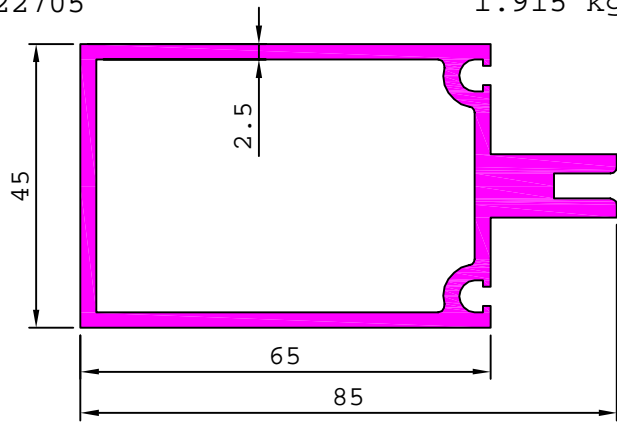

22765 1.254 kg/m

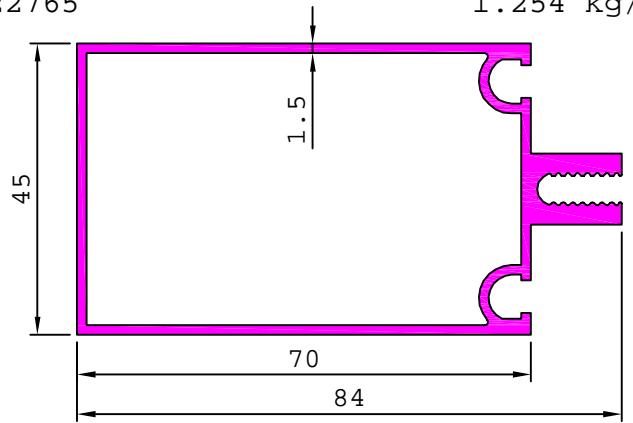

35680 1.708 kg/m

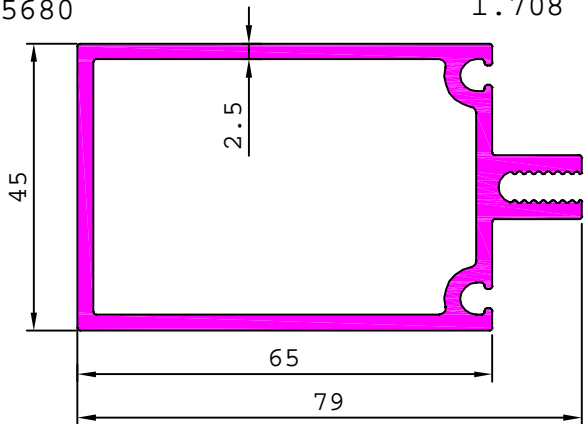

22720 2.341 kg/m

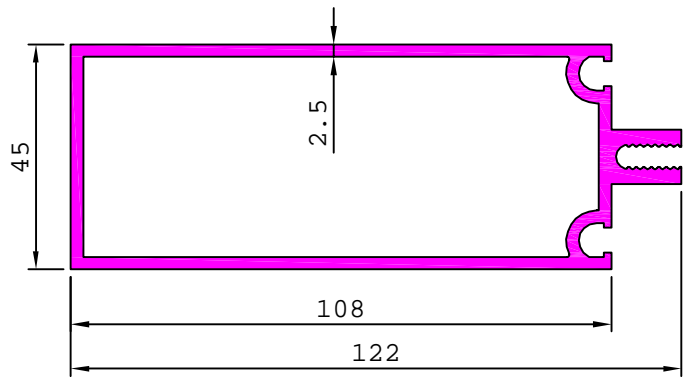

36004 2.006 kg/m

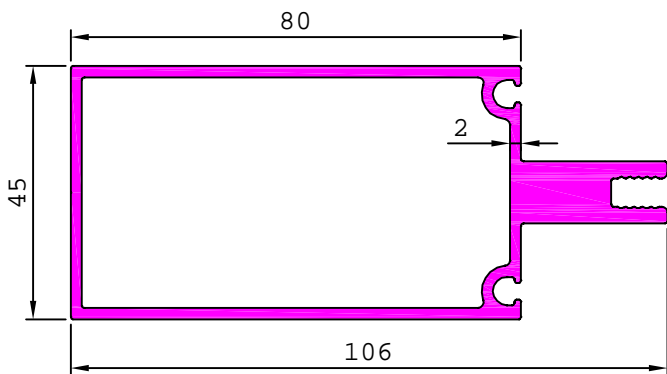

22777 1.889 kg/m

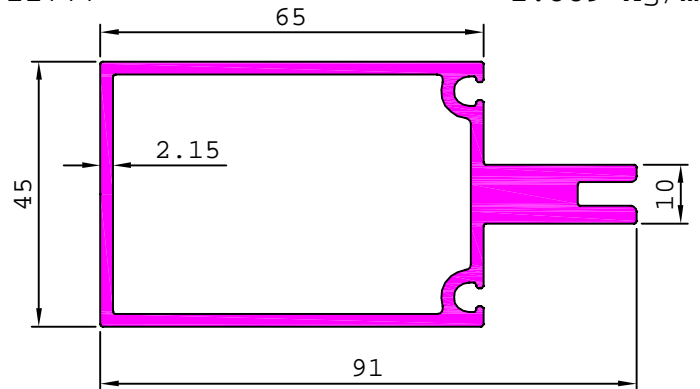

22782 1.532 kg/m

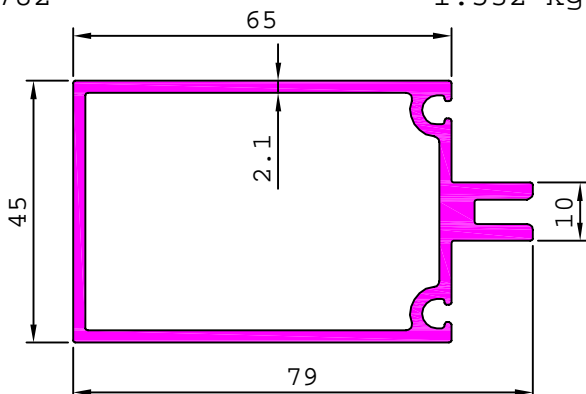

35985 1.133 kg/m

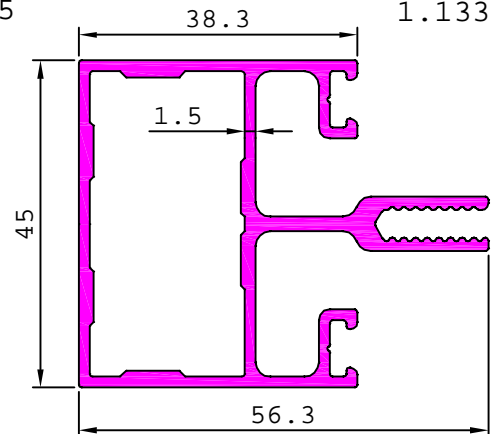

### CURTAIN WALL SECTION - 45 mm.

35650

2.545 kg/m

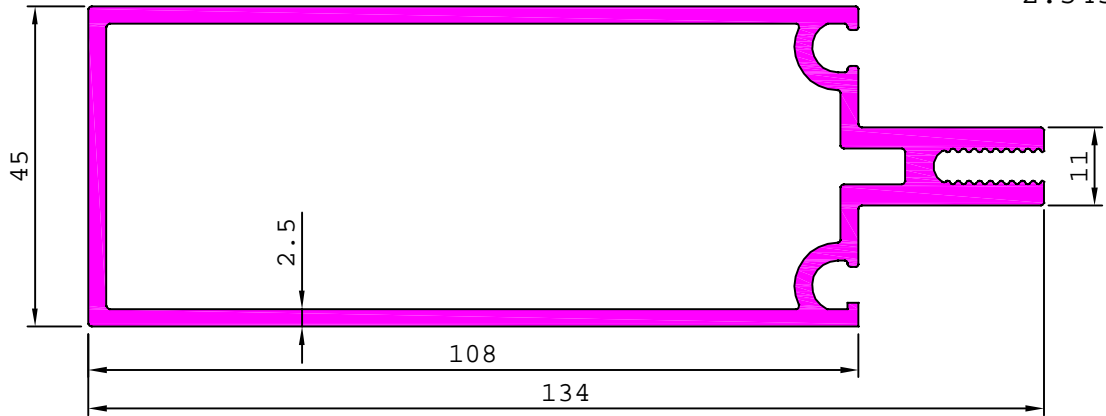

35751

3.537 kg/m

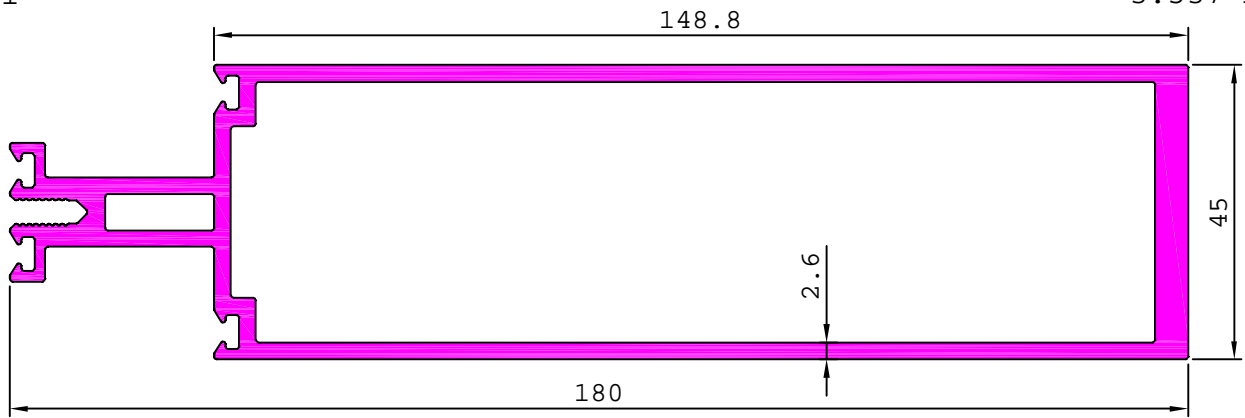

## CURTAIN WALL SECTION - 50 mm.

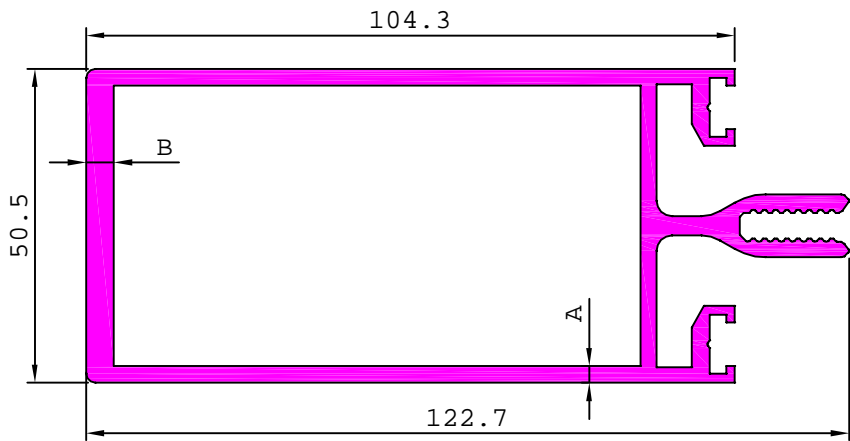
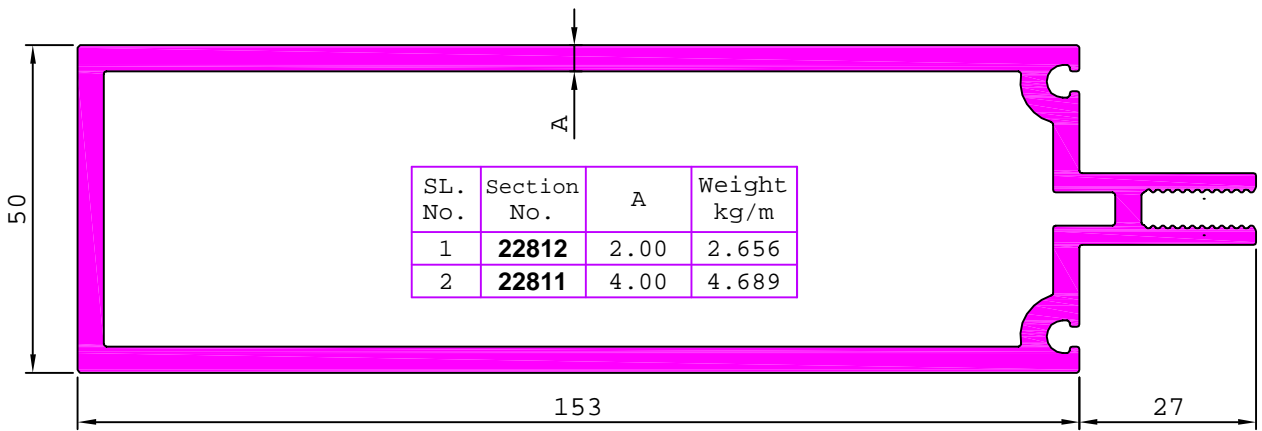
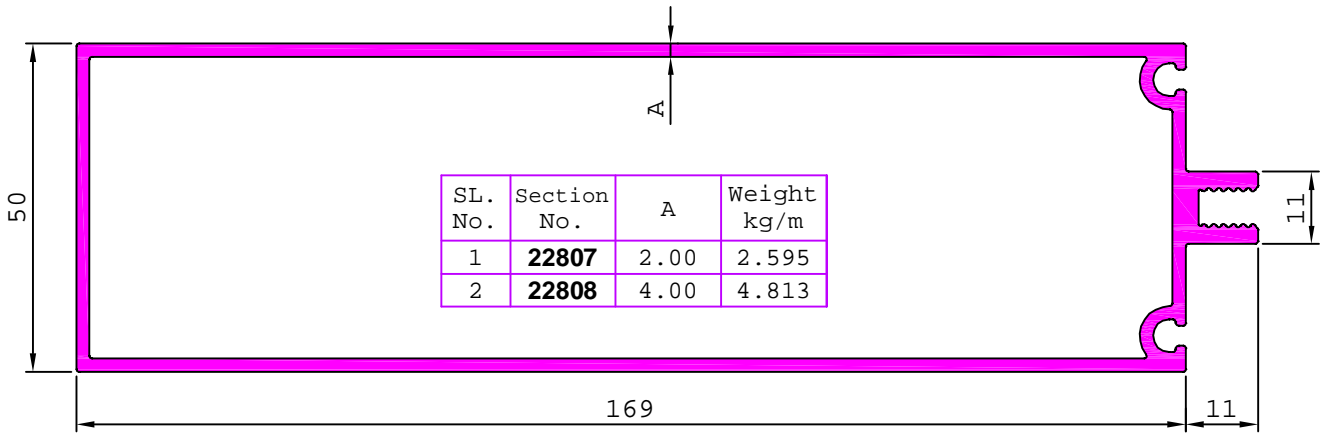

36001 0.252 kg/m

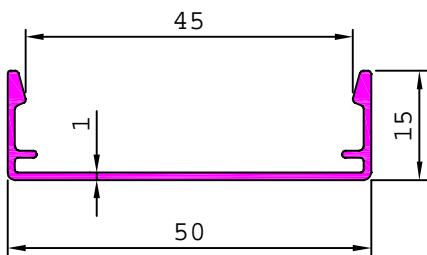

36002 0.219 kg/m

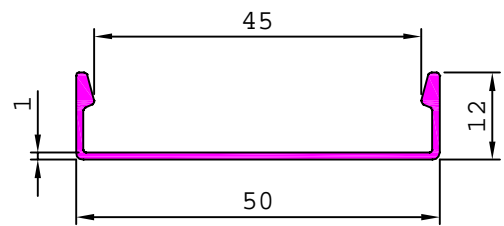

## CURTAIN WALL SECTION - 50 mm.

36003

0.365 kg/m

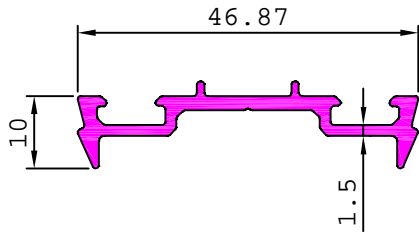

**MATCHING SECTION No. 36268,G102062**

36268

0.375 kg/m

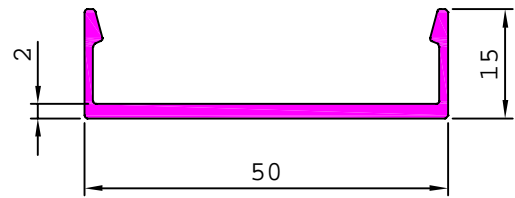

**MATCHING SECTION No. 36003**

36261

0.384 kg/m

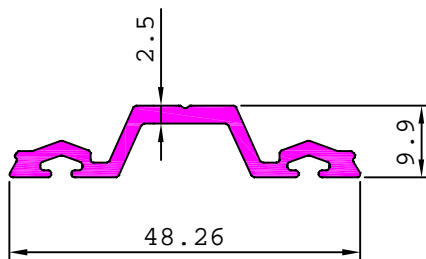

36260

0.283 kg/m

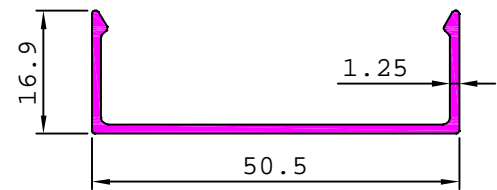

22773

0.318 kg/m

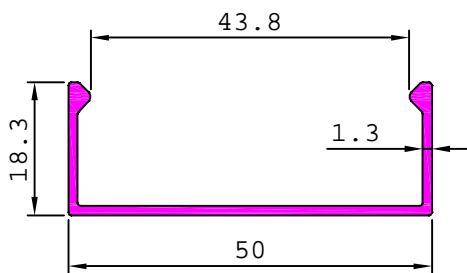

22774

0.404 kg/m

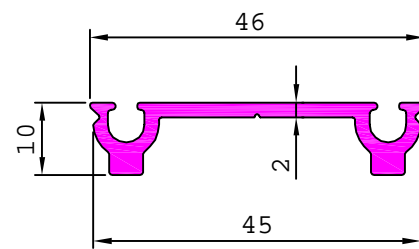

22797

1.485 kg/m

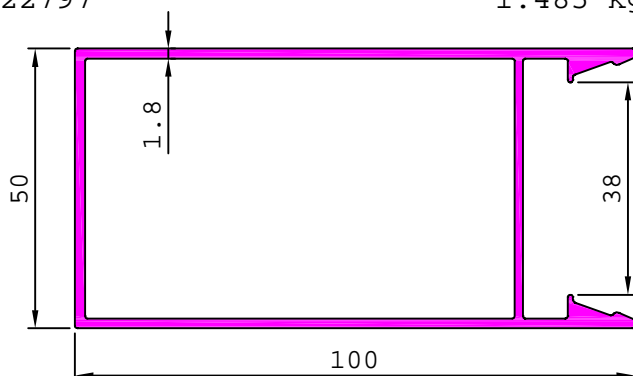

**MATCHING SECTION No. 22798**

22798

0.447 kg/m

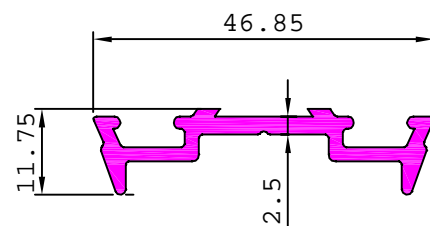

**MATCHING SECTION No. 22797**

**CURTAIN WALL SECTION - 50 mm.**

S6438

0.515 kg/m

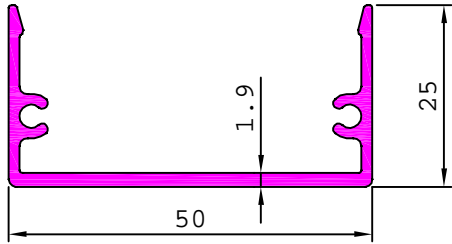

S6439

0.360 kg/m

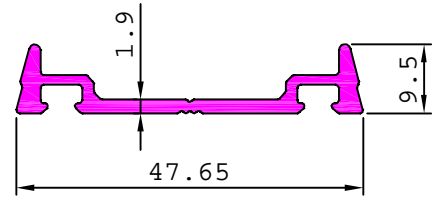

22850

2.926 kg/m

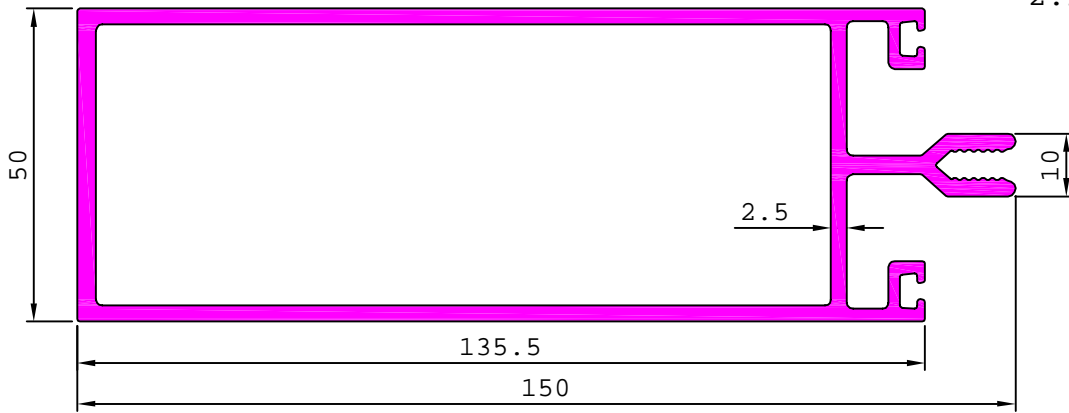

22849

2.264 kg/m

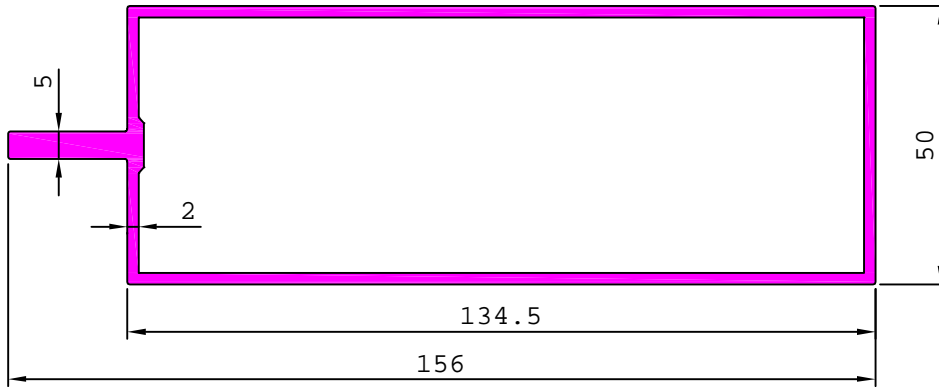

22784

3.775 kg/m

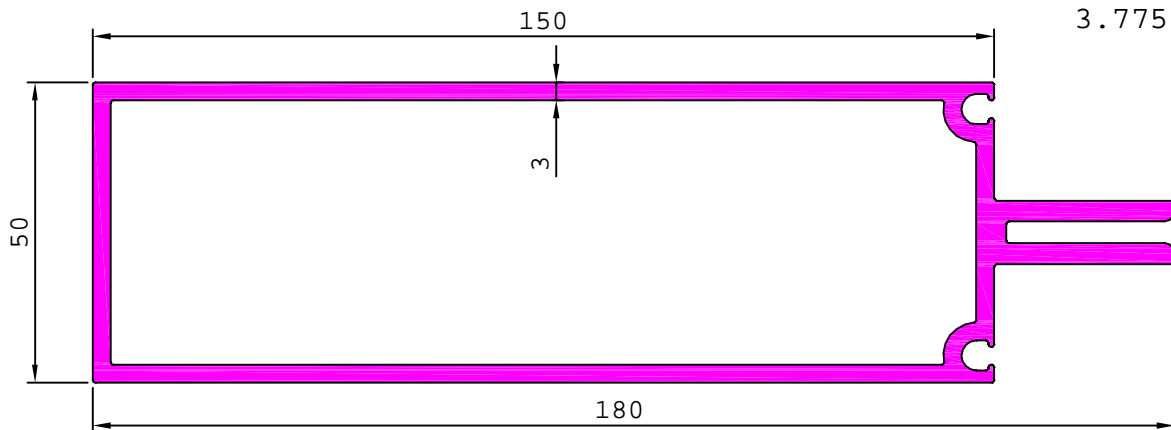

### CURTAIN WALL SECTION - 50 mm.

22775

5.291 kg/m

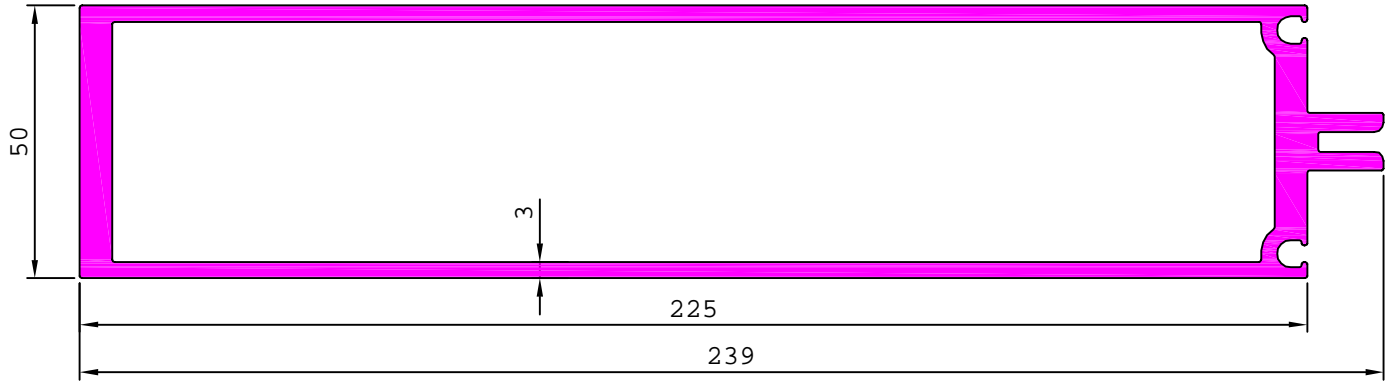

22787

3.440 kg/m

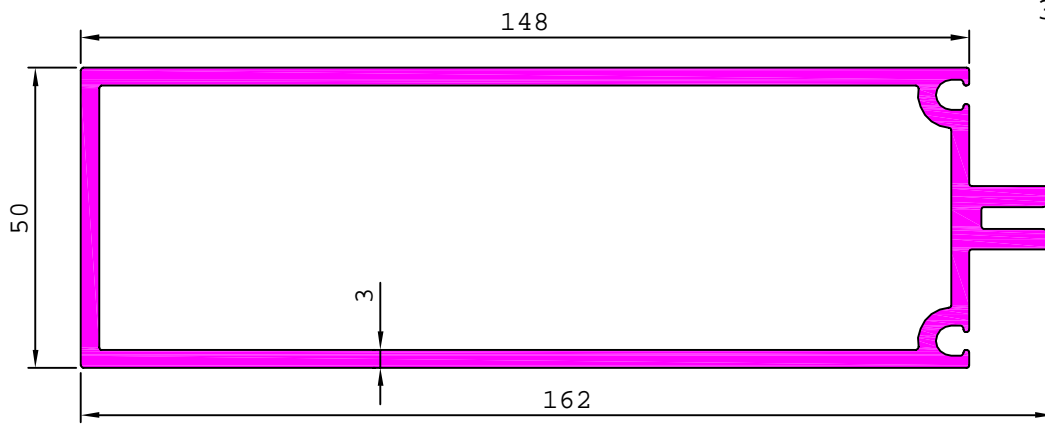

35998

2.910 kg/m

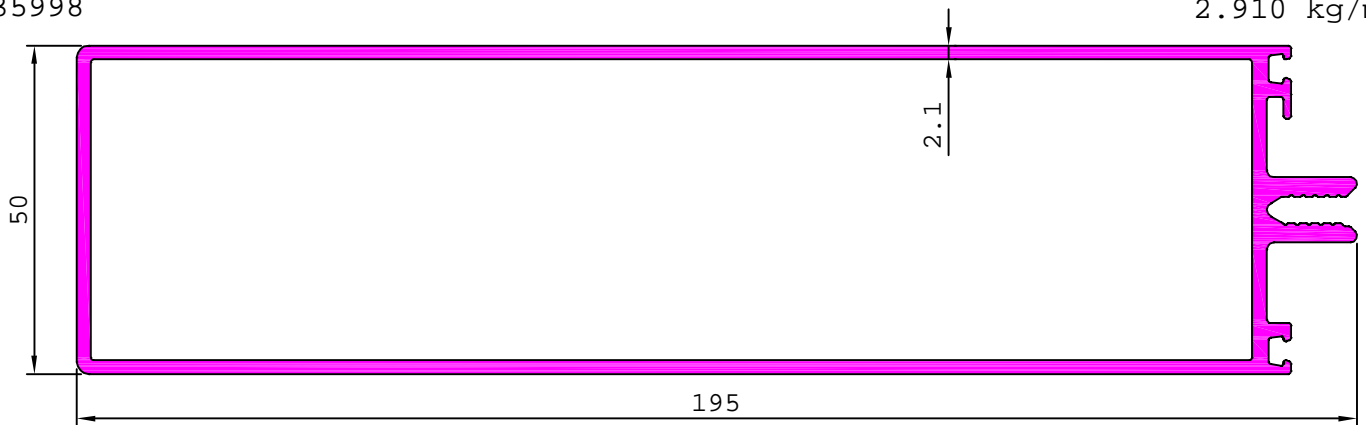

22835

1.976 kg/m

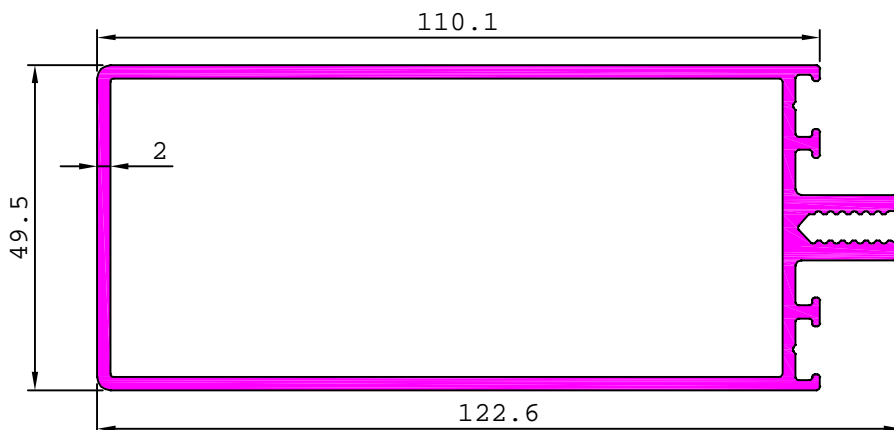

## CURTAIN WALL SECTION - 50 mm.

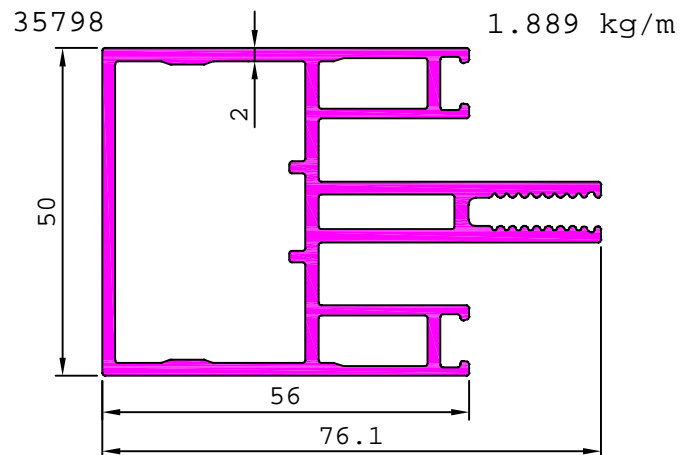
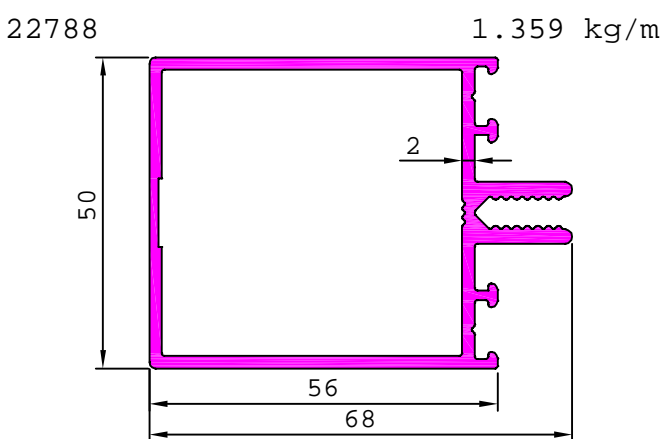
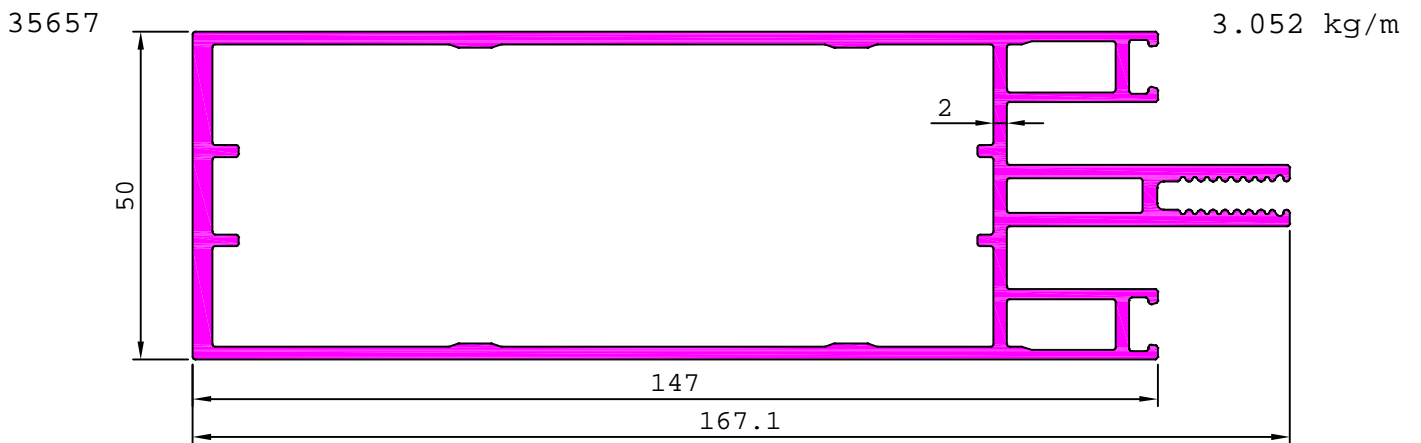
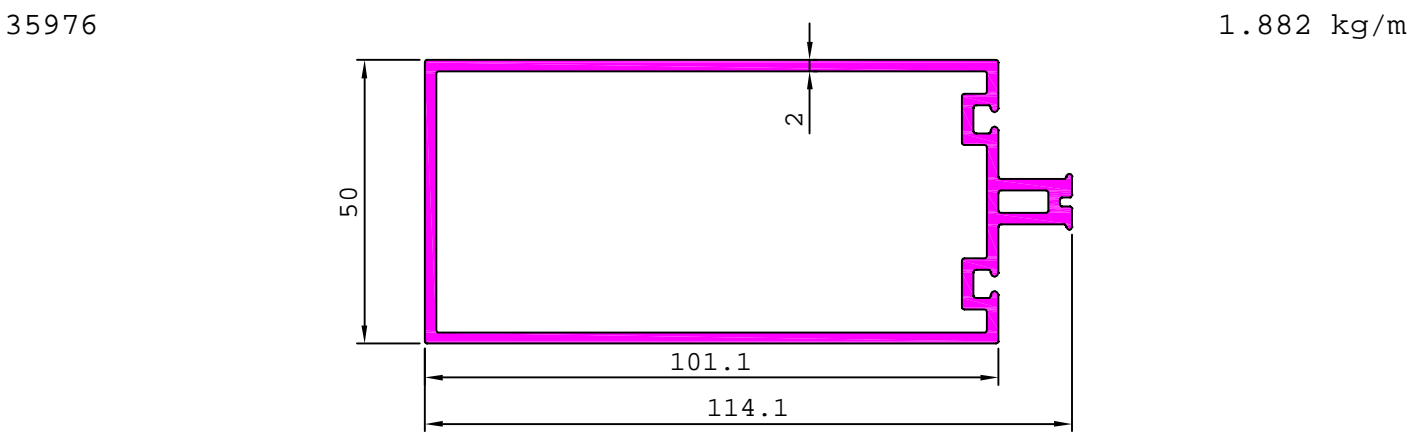
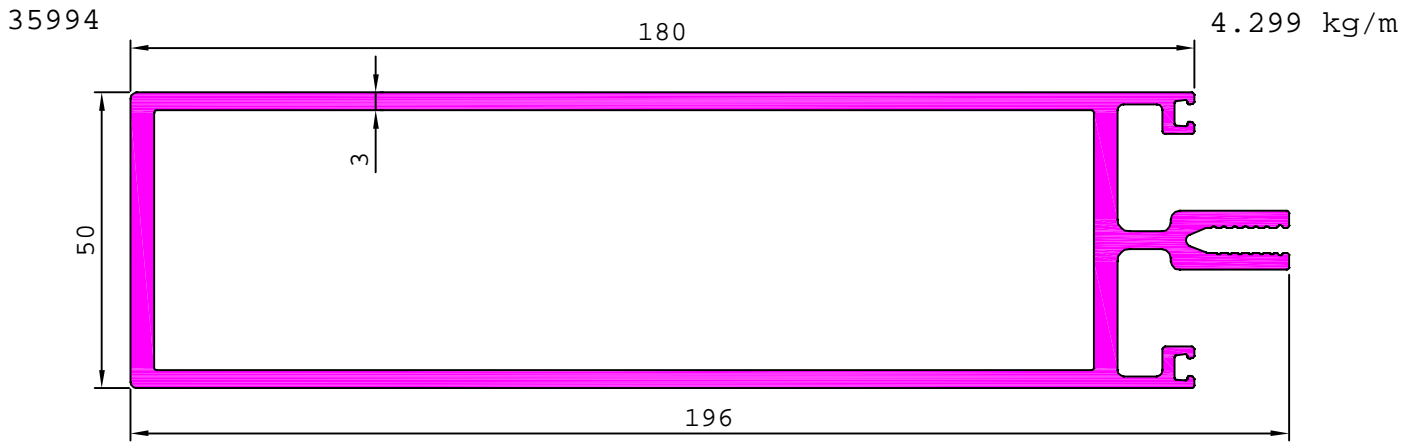

## CURTAIN WALL SECTION - 50 mm.

35799

3.230 kg/m

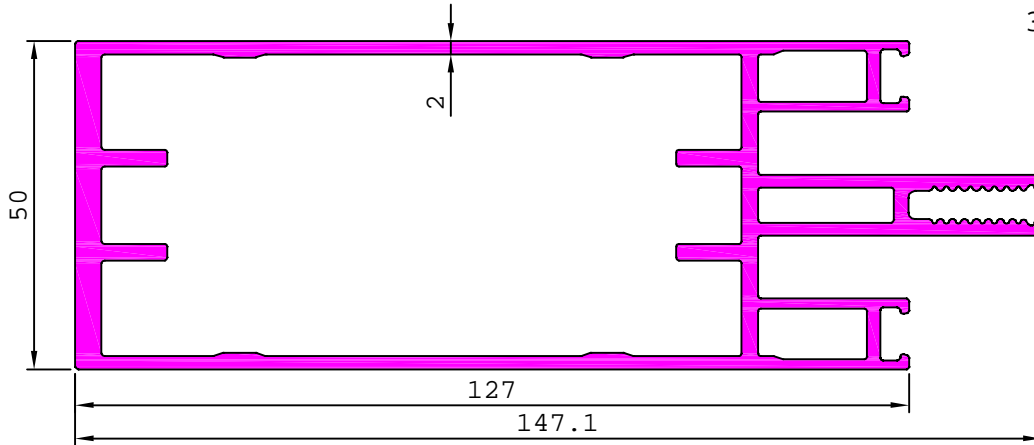

35800

0.548 kg/m

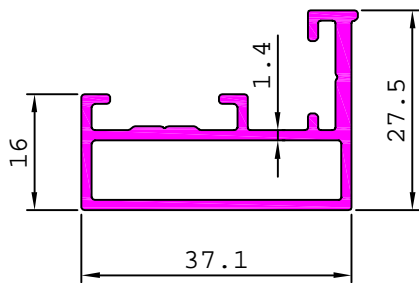

35801

0.822 kg/m

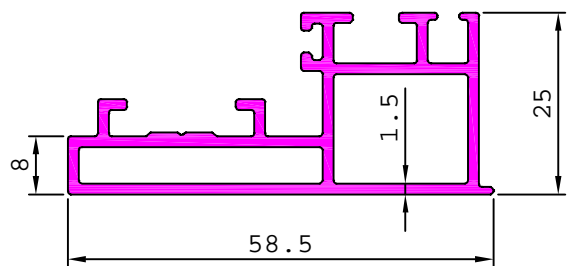

S6407

1.276 kg/m

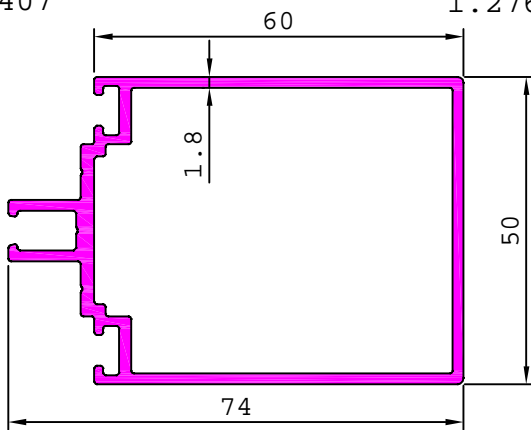

S6406

1.790 kg/m

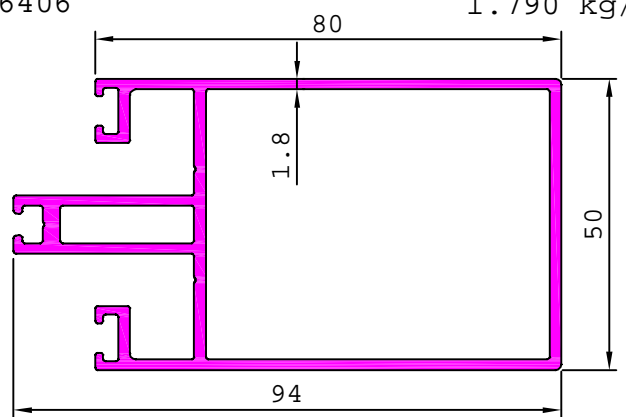

36223

2.865 kg/m

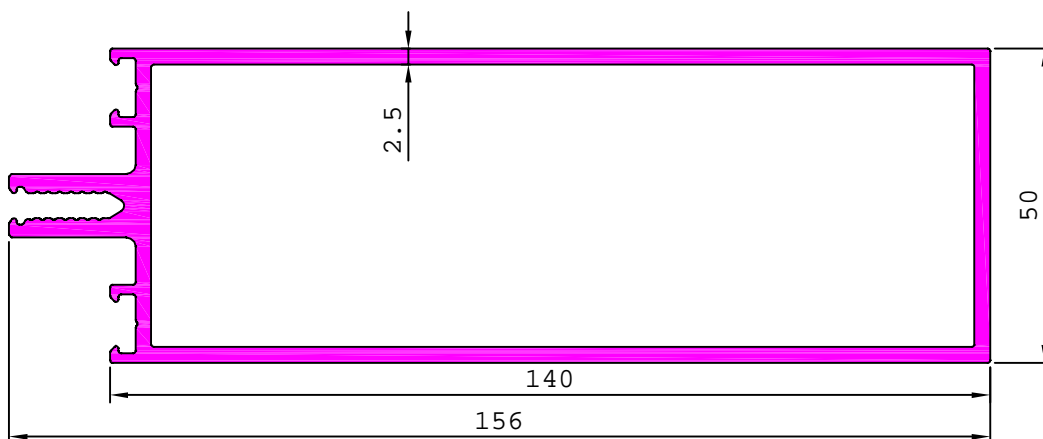

## CURTAIN WALL SECTION - 50 mm.

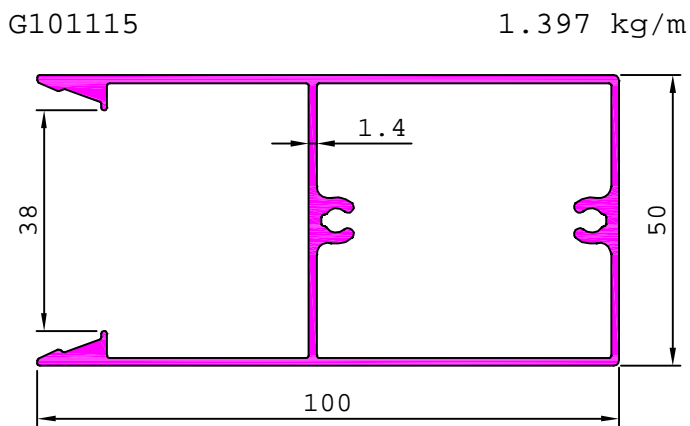
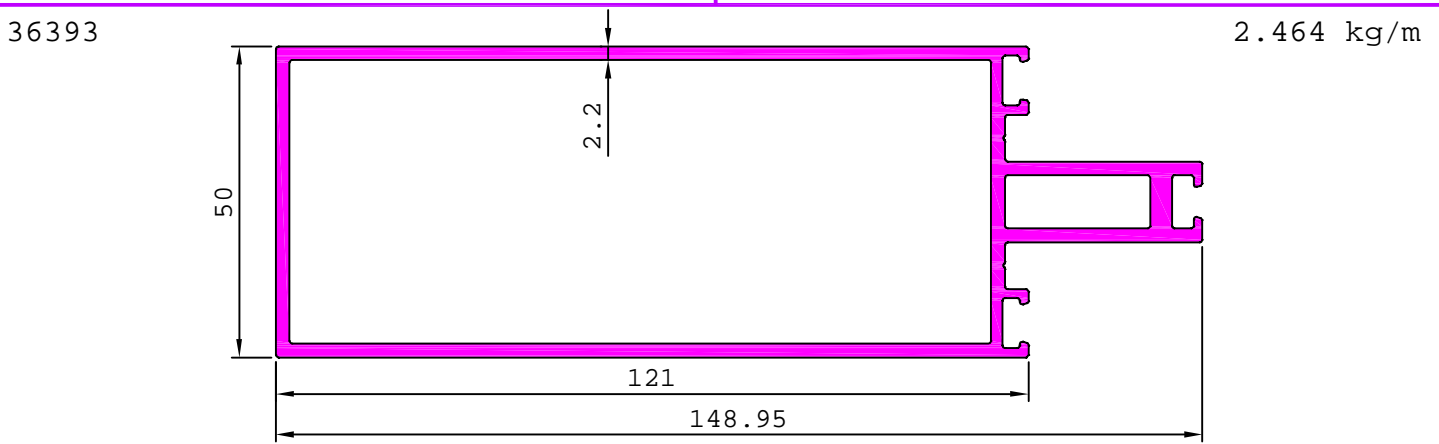
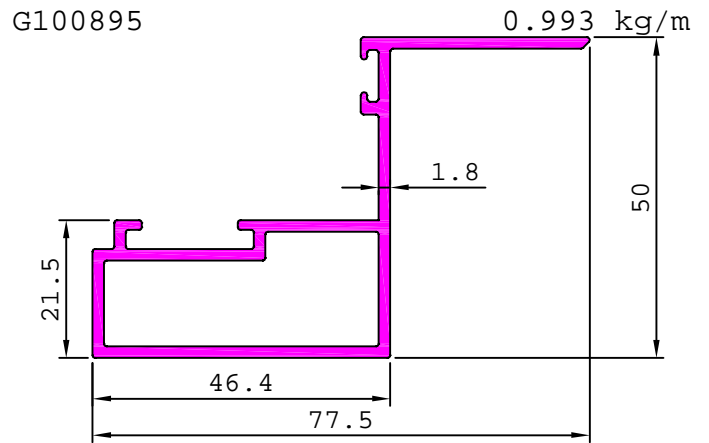
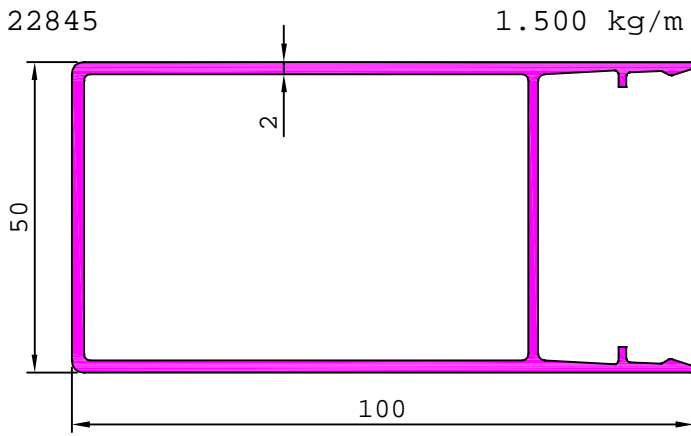

MATCHING WITH 22798

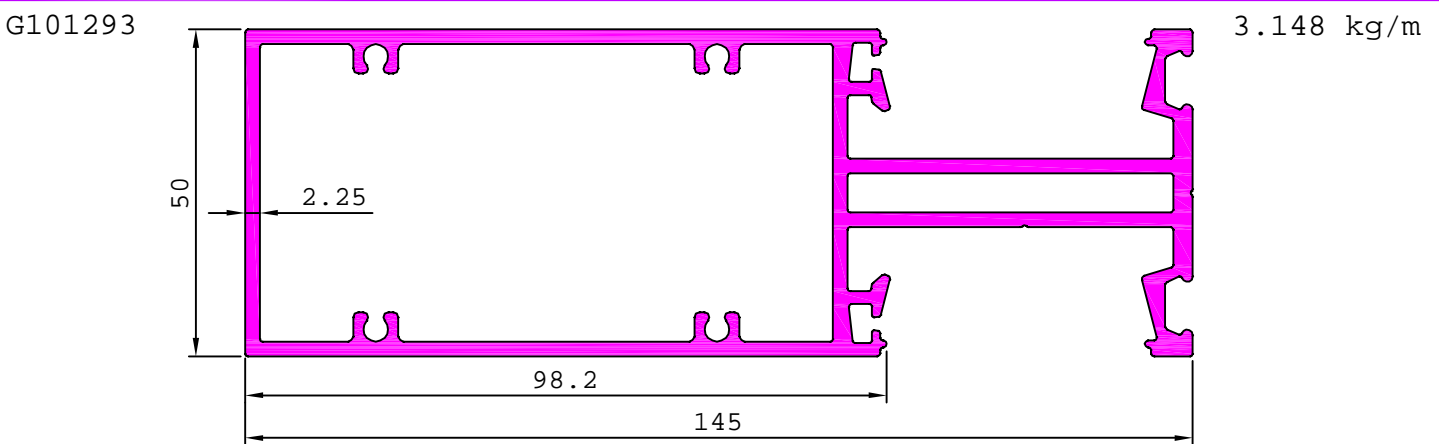
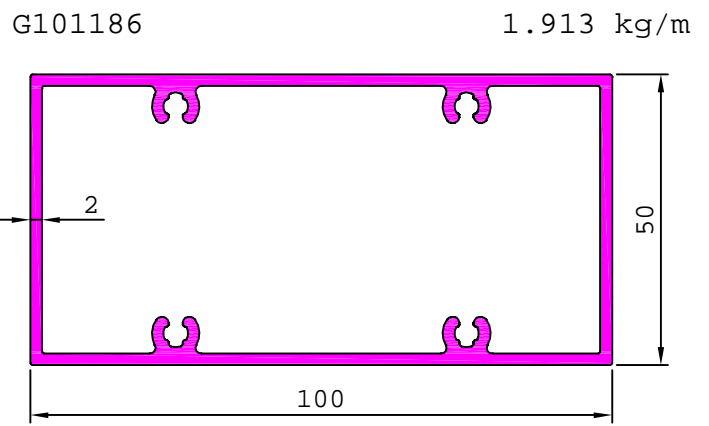

# CURTAIN WALL SECTION - 50 mm.

G101833

3.045 kg/m

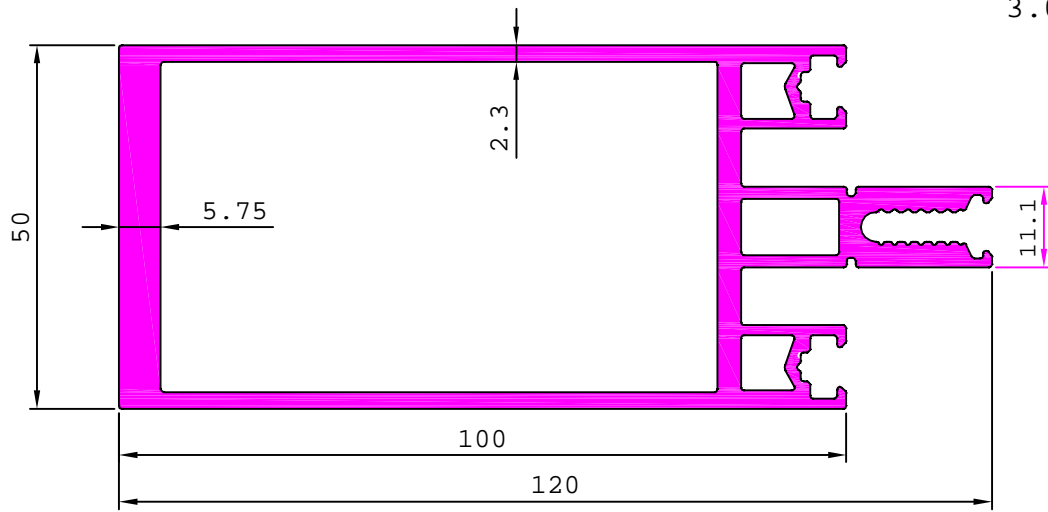

## CURTAIN WALL SECTION - 54 mm.

22729

0.441 kg/m

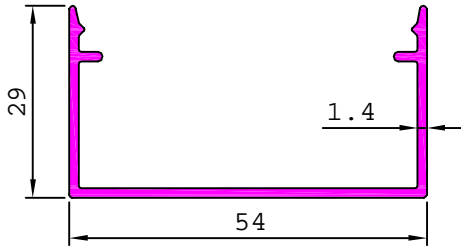

22731

0.527 kg/m

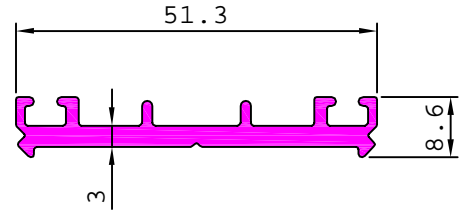

22728

0.366 kg/m

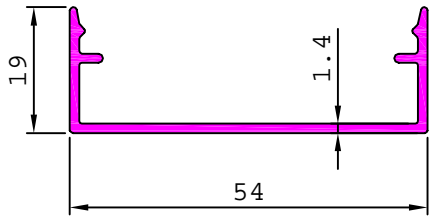

22730

0.820 kg/m

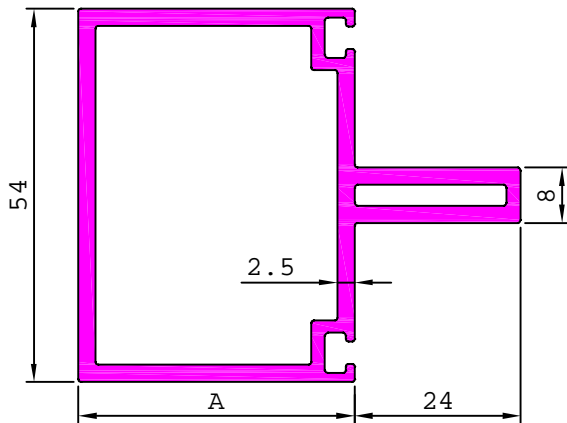
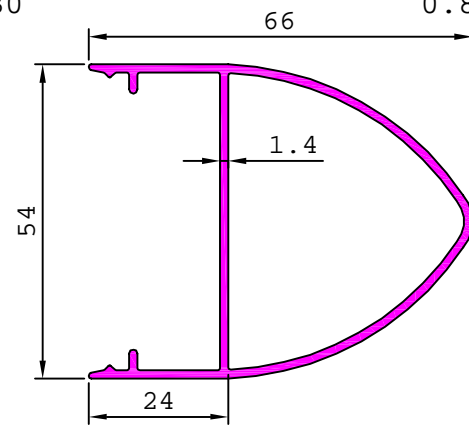

SL. No.	Section No.	A	Weight kg/m
1	29217	40.00	1.557
2	29218	100.00	2.367

22725

1.476 kg/m

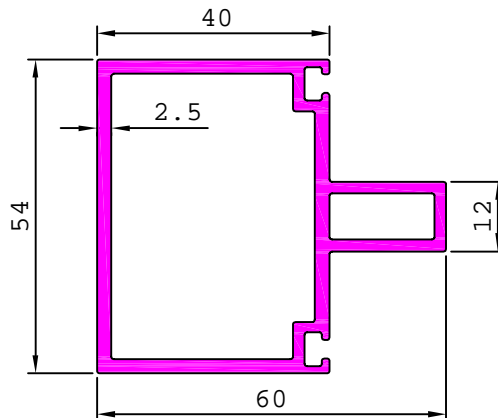

**CURTAIN WALL SECTION - 54 mm.**

22734

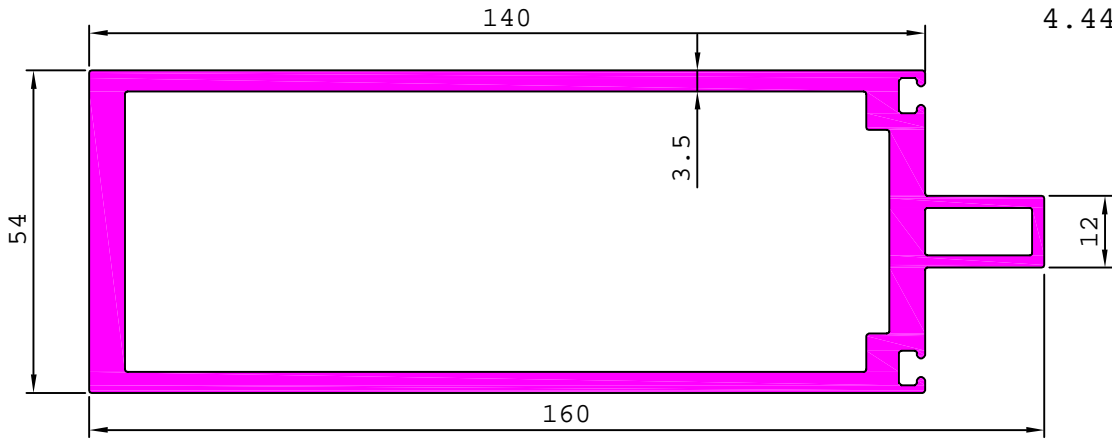

4.443 kg/m

35521

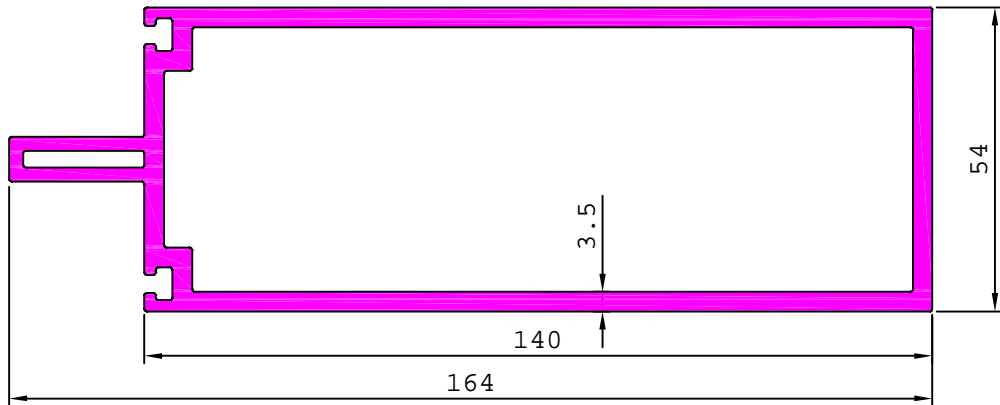

3.961 kg/m

35835

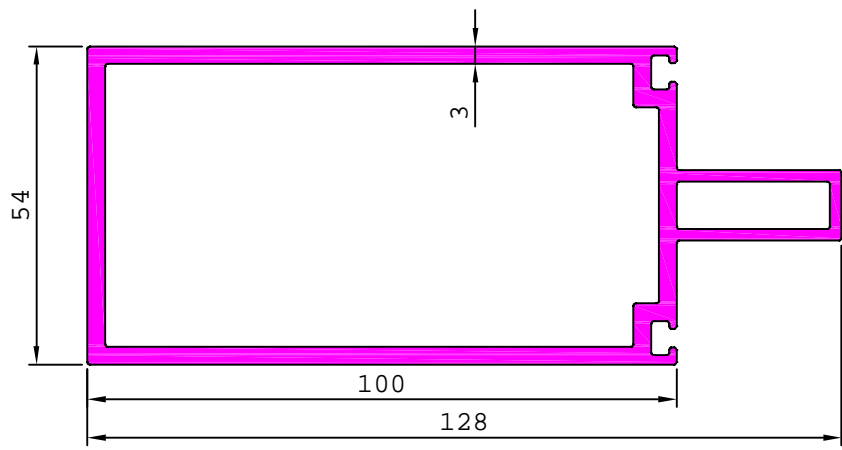

2.798 kg/m

22727

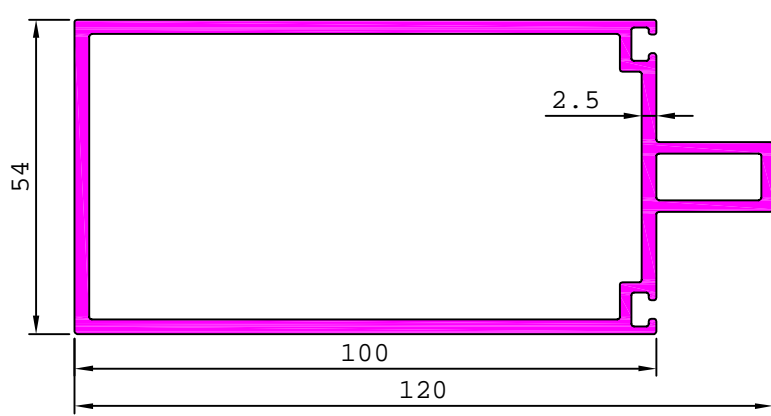

2.286 kg/m

## CURTAIN WALL SECTION - 55 mm.

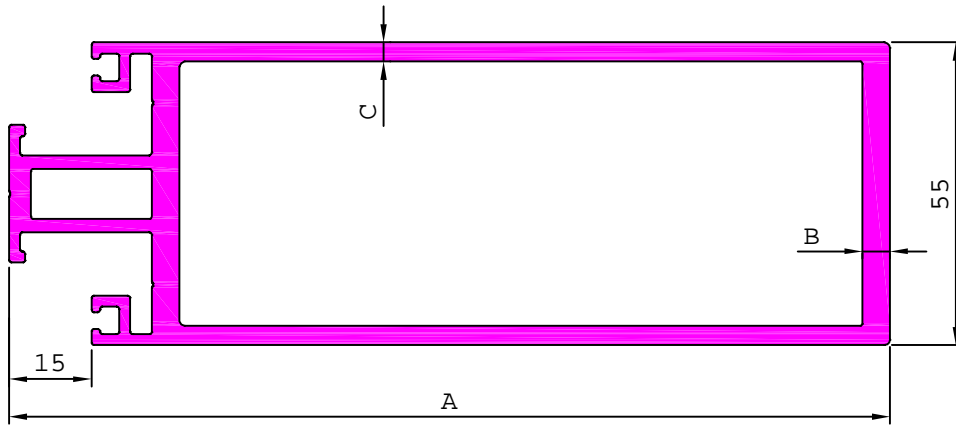

SL. No.	Section No.	A	B	C	Weight kg/m
1	<b>36162</b>	160.00	5.00	3.50	4.611
2	<b>36065</b>	165.00	5.00	3.75	4.877

36052

3.707 kg/m

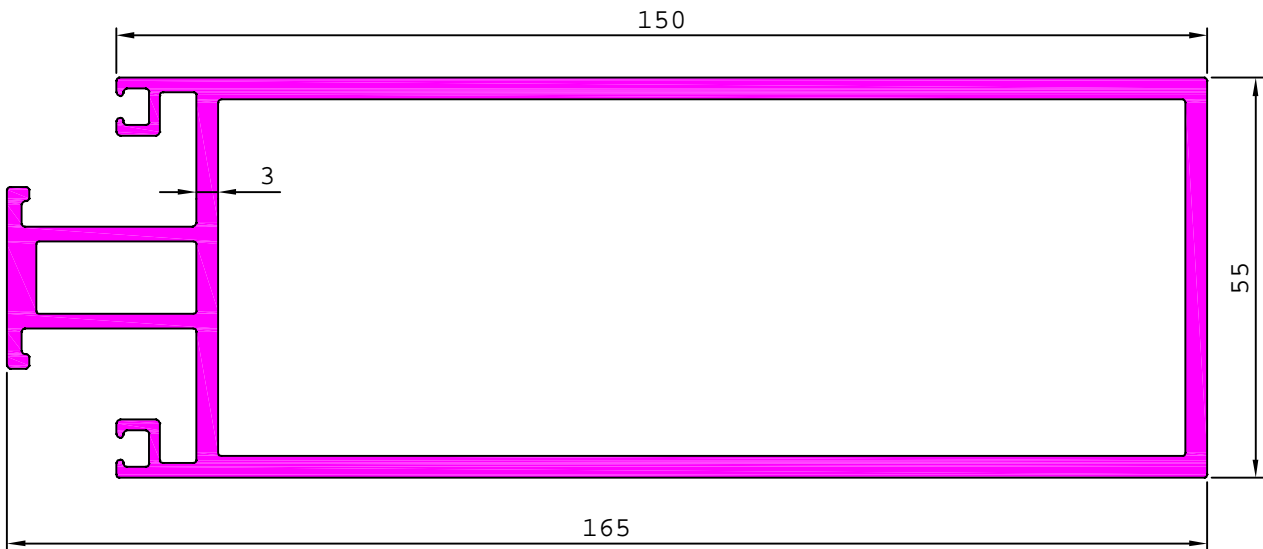

35642

2.591 kg/m

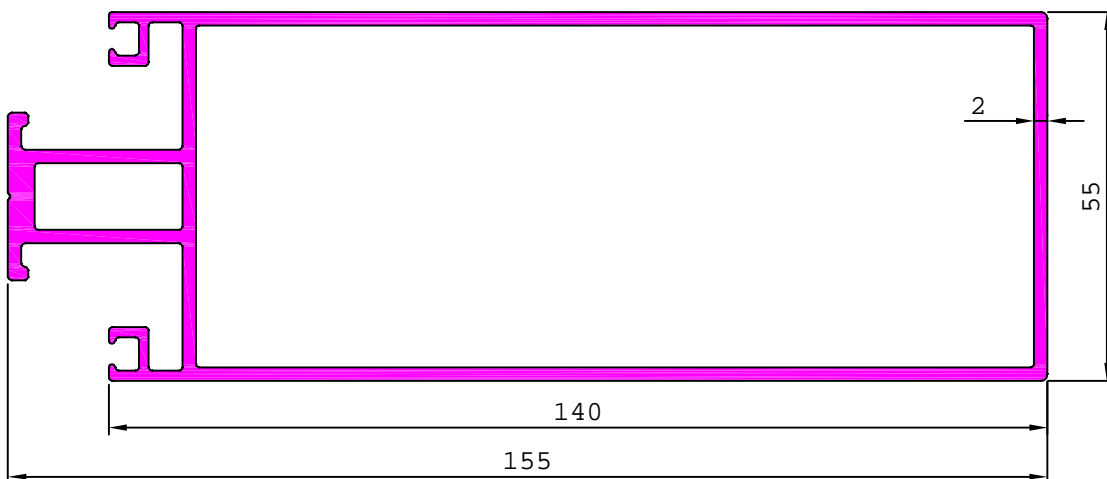

## CURTAIN WALL SECTION - 55 mm.

35707

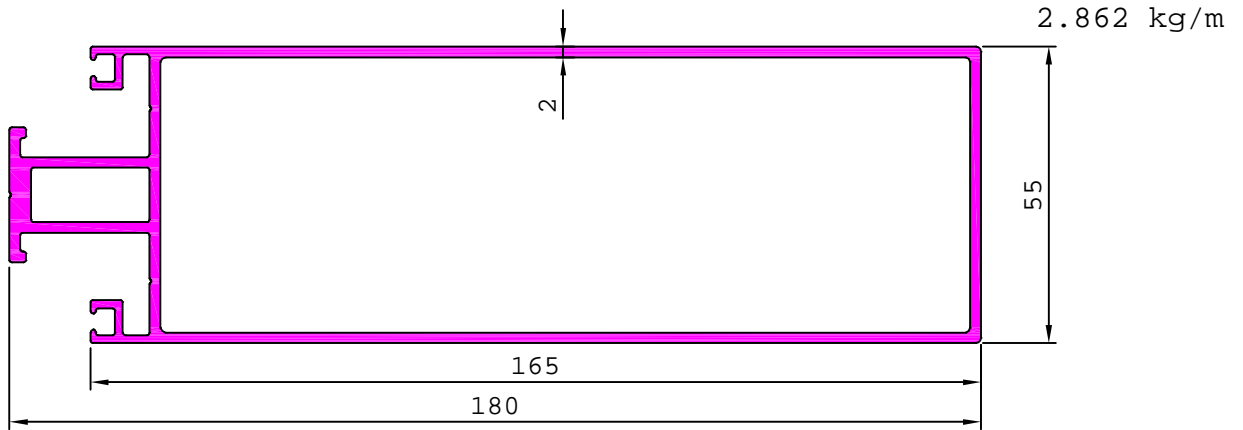

36022

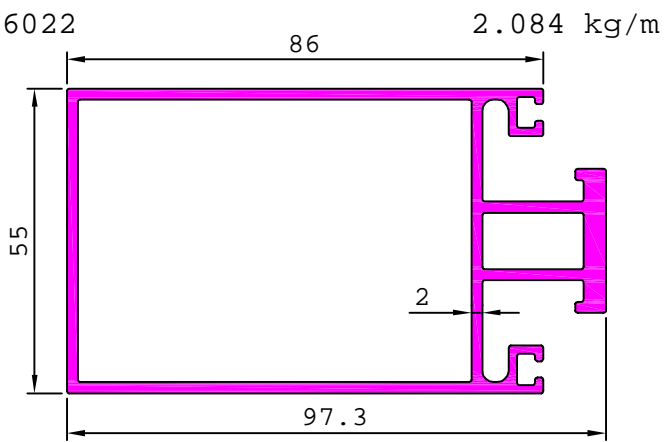

36053

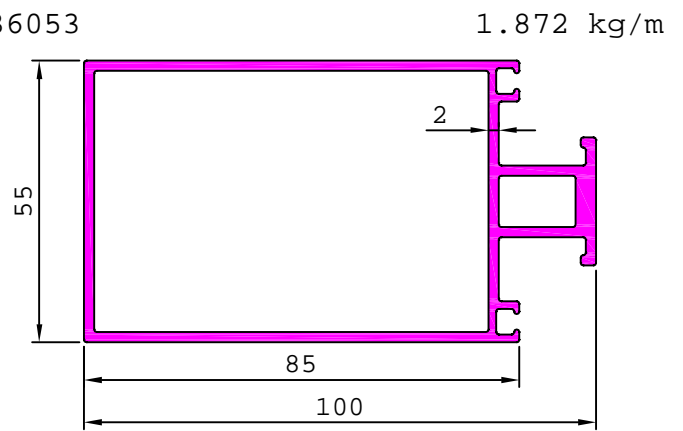

35679

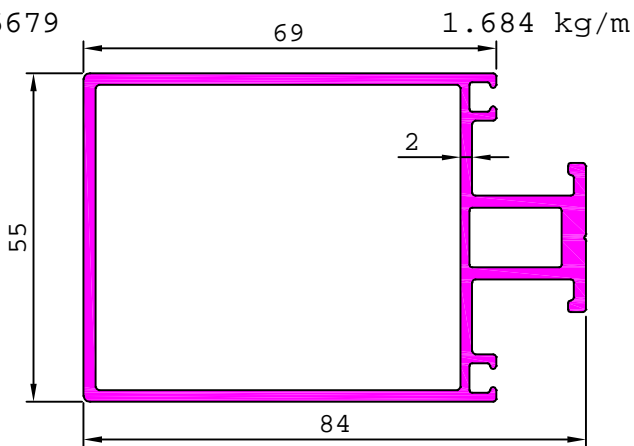

35978

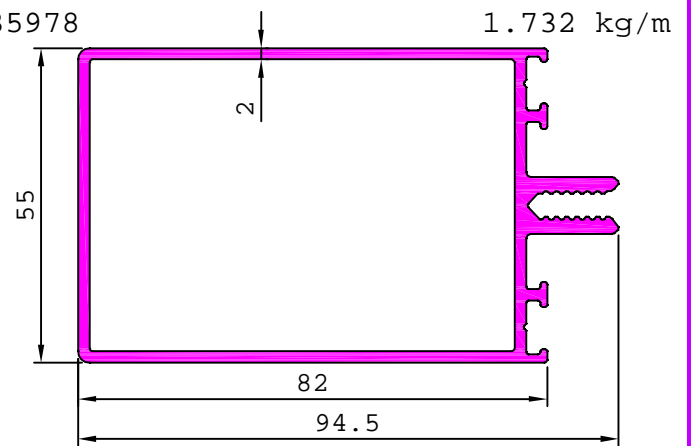

36123

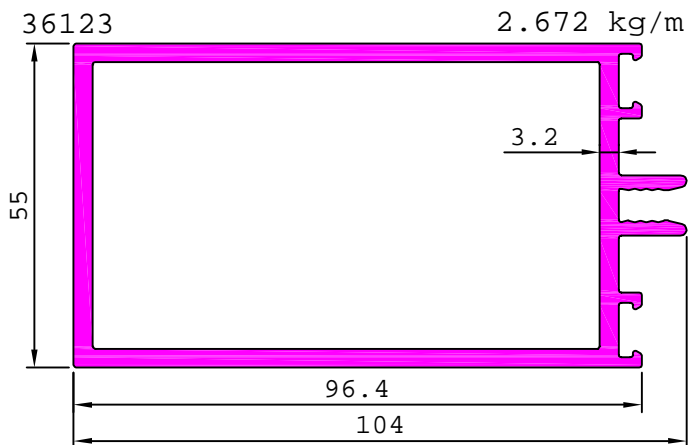

35568

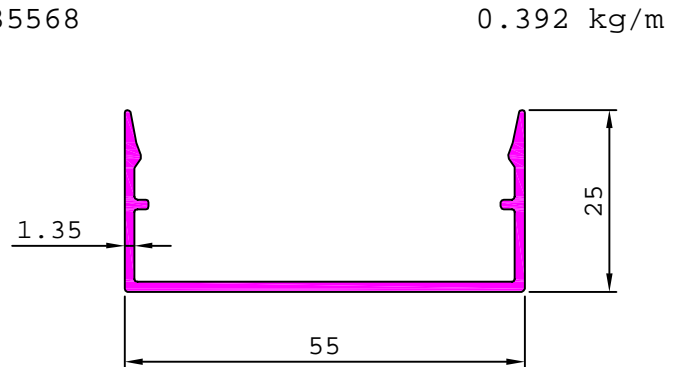

## CURTAIN WALL SECTION - 55 mm.

22748

1.701 Kg/m

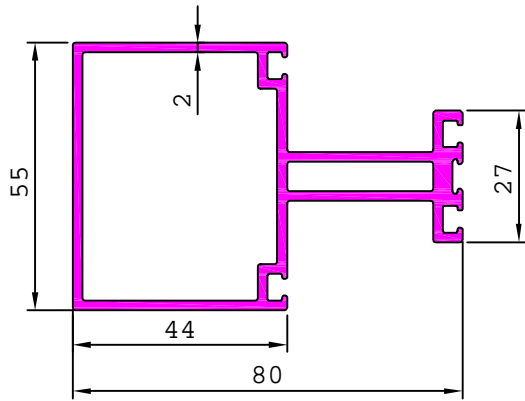

22749

2.783 Kg/m

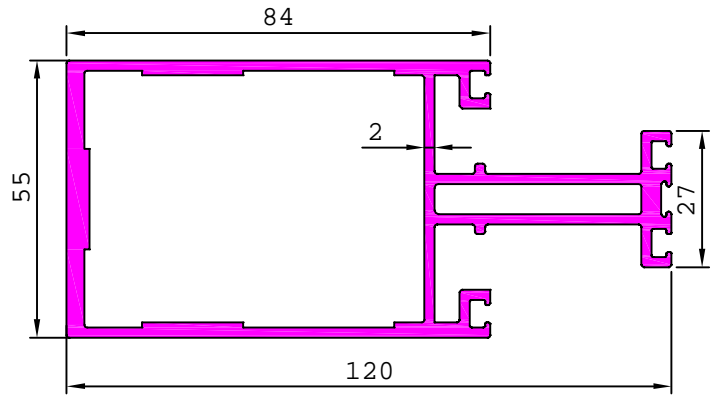

29190

0.277 kg/m

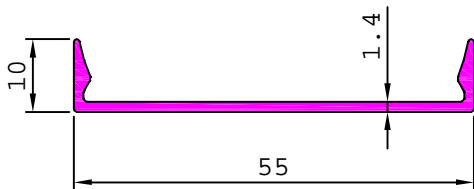

29191

0.532 kg/m

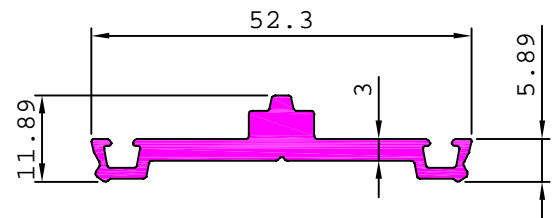

S6209

0.468 kg/m

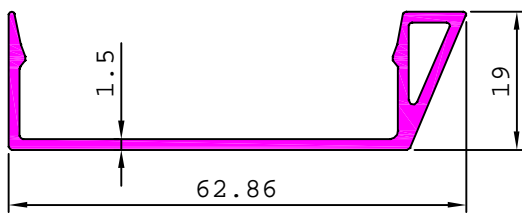

S6210

0.568 kg/m

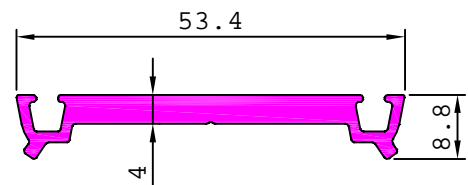

MATCHING WITH S6209, S6211

S6211

0.335 kg/m

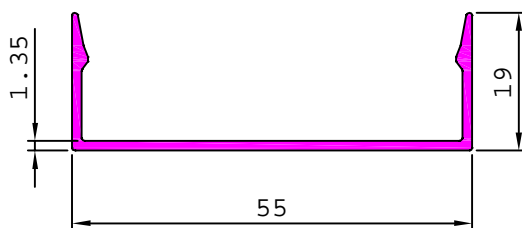

35567

0.531 kg/m

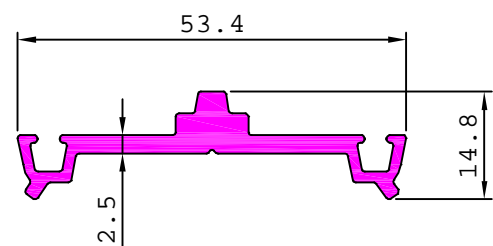

### CURTAIN WALL SECTION - 55 mm.

G100780

2.745 Kg/m

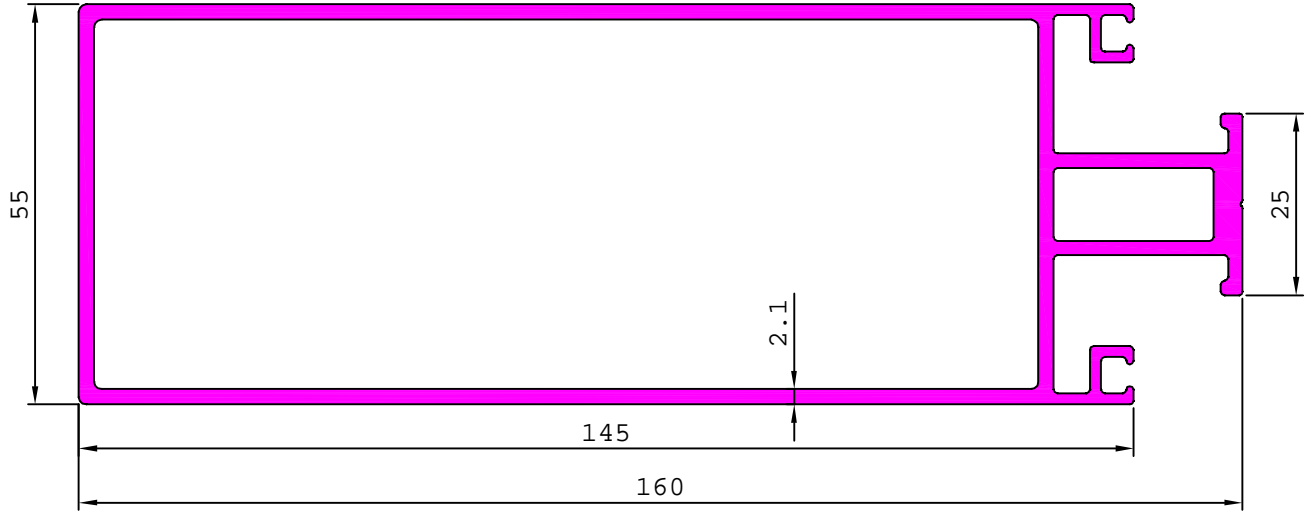

G100781

2.020 Kg/m

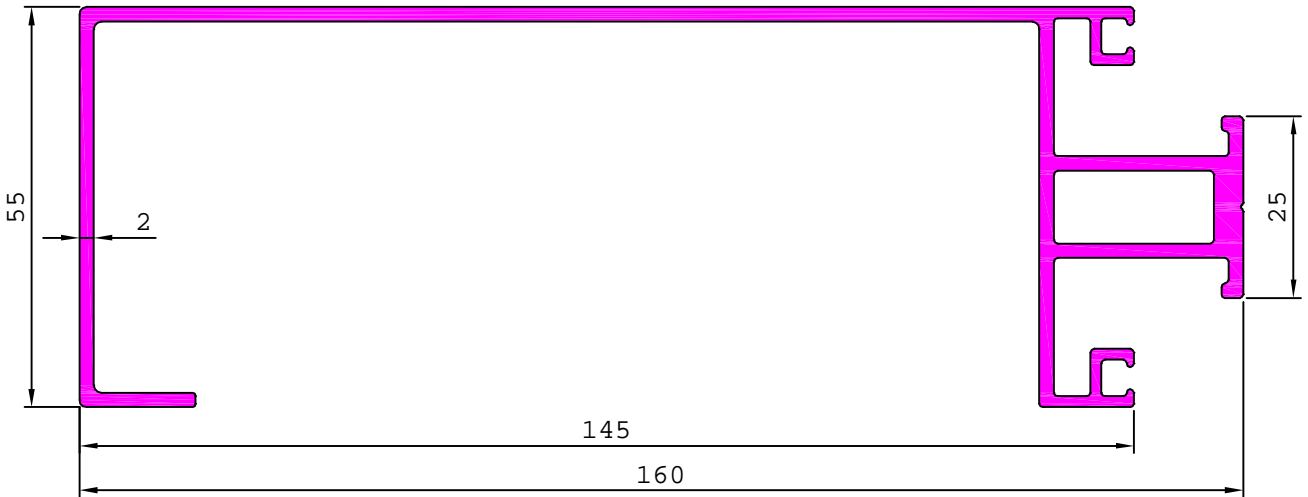

G101118

2.334 Kg/m

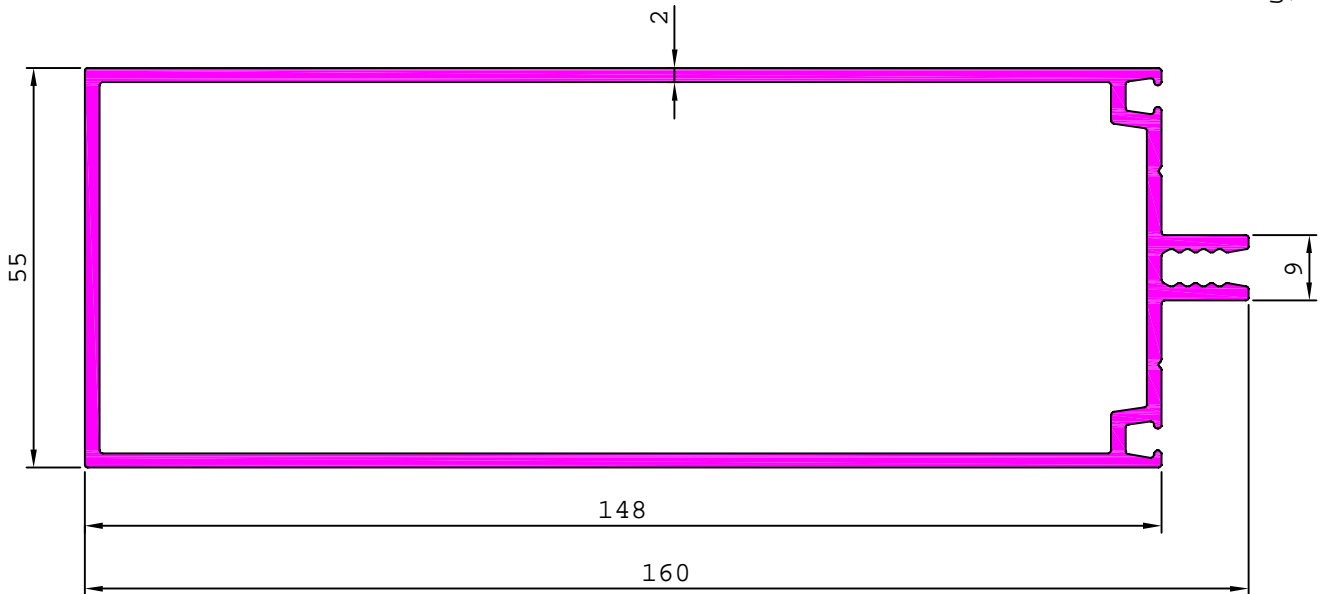

MATCHING WITH G101119

**CURTAIN WALL SECTION - 55 mm.**

G101119

0.406 kg/m

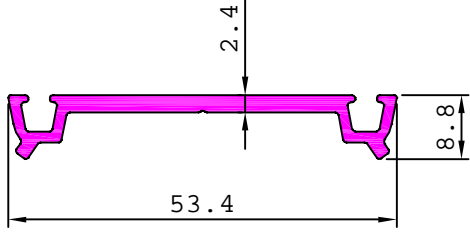

MATCHING WITH G101118,G101120

G101120

0.342 kg/m

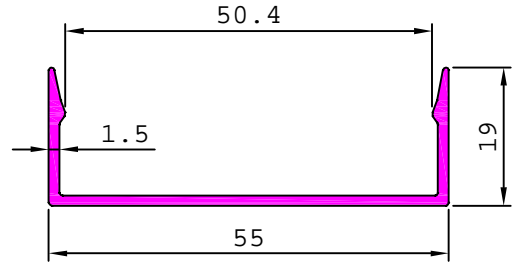

MATCHING WITH G101119

G101581

2.751 kg/m

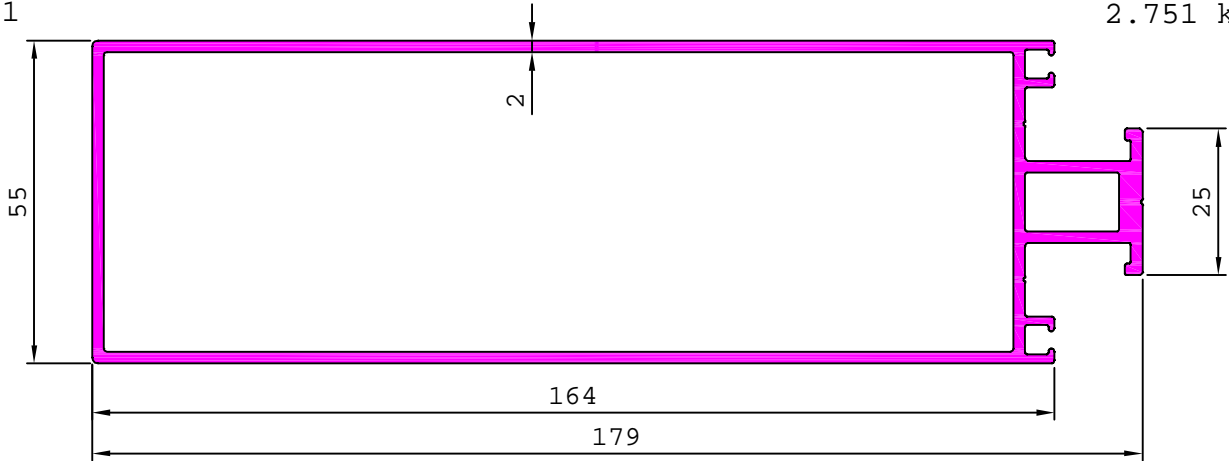

G101580

2.481 kg/m

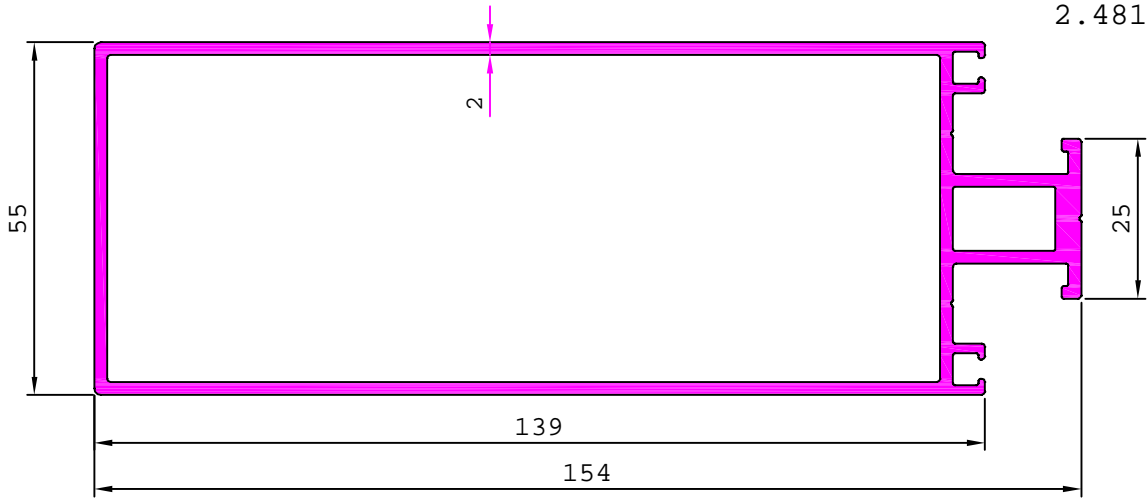

G101579

2.020 kg/m

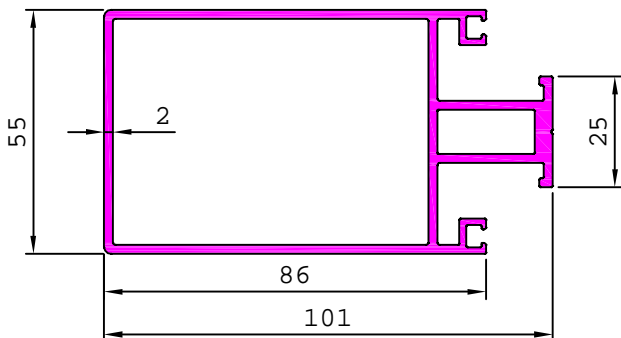

# CURTAIN WALL SECTION - 55 mm.

G101452

2.182 kg/m

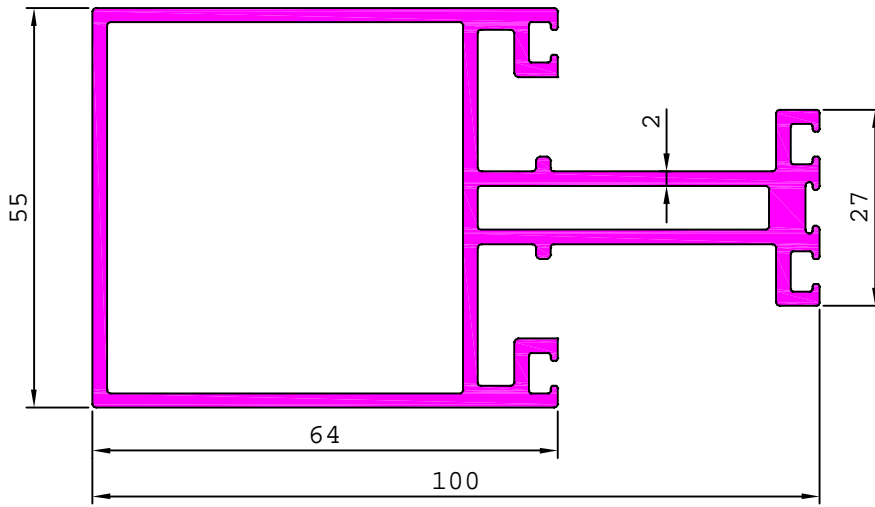

## CURTAIN WALL SECTION - 56 mm.

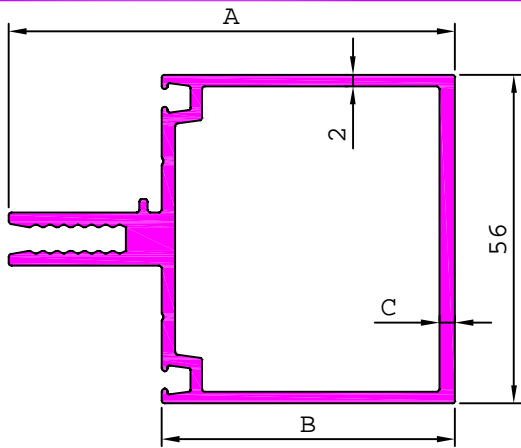

SL. No.	Section No.	A	B	C	Weight kg/m
1	<b>29188</b>	56.00	30.00	2.70	1.458
2	<b>29187</b>	76.00	50.00	2.70	1.674
3	<b>29189</b>	131.00	105.00	2.70	2.268
4	<b>35637</b>	166.00	140.00	2.00	2.517
5	<b>35638</b>	91.00	65.00	2.00	1.707
6	<b>35639</b>	181.00	155.00	2.00	2.679

35818

2.357 kg/m

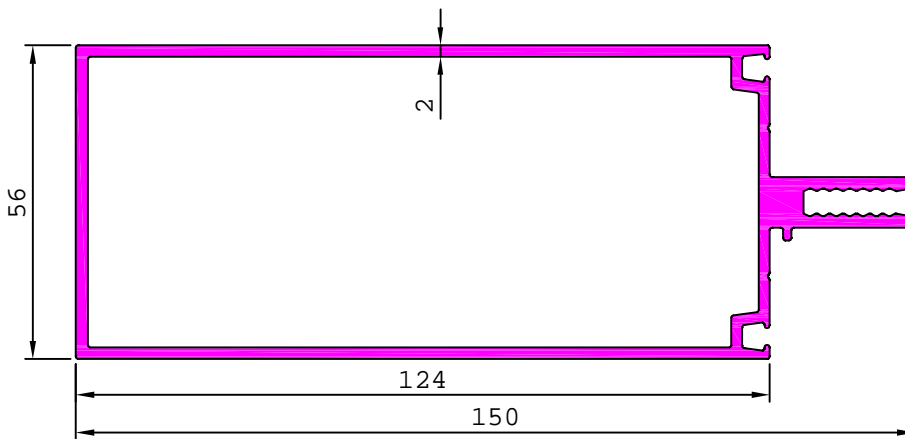

29148

2.859 kg/m

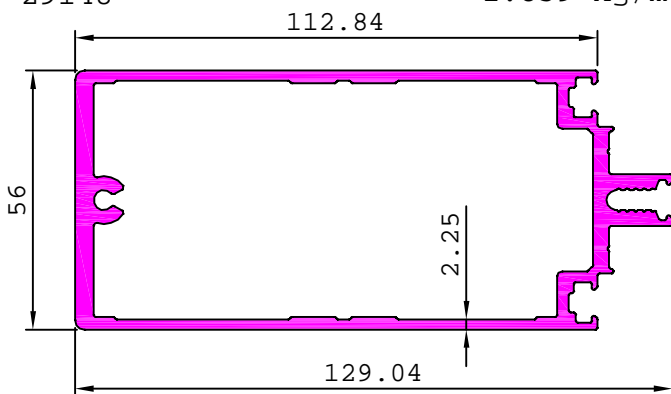

29149

3.309 kg/m

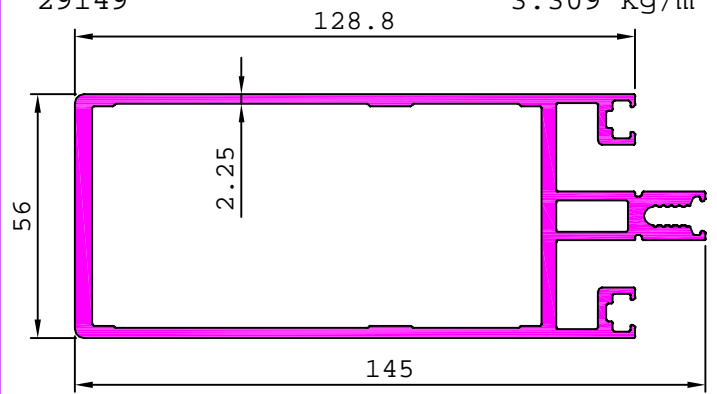

35546

1.301 kg/m

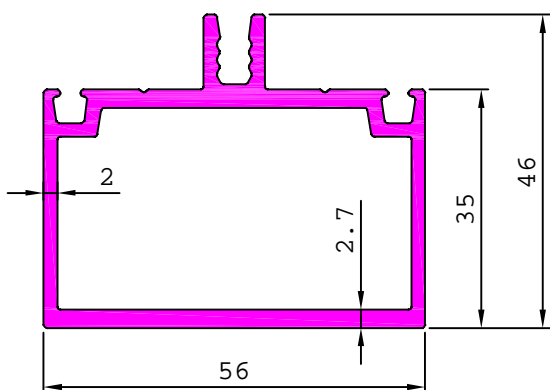

## CURTAIN WALL SECTION - 57 mm.

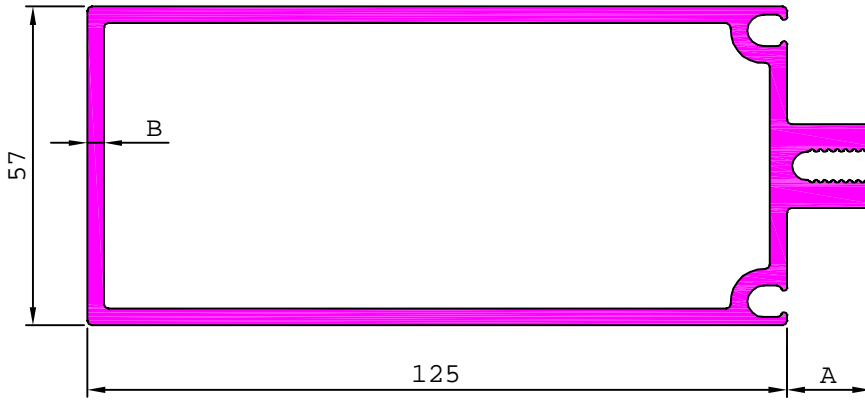

SL. No.	Section No.	A	B	Weight kg/m
1	<b>35793</b>	15.00	3.00	3.308
2	<b>S6012</b>	14.30	3.75	4.097

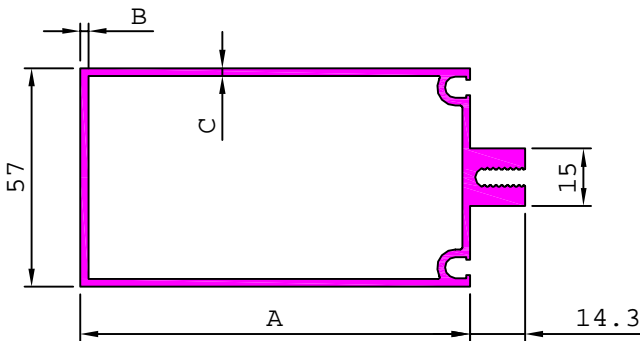

SL. No.	Section No.	A	B	C	Weight kg/m
1	<b>22715</b>	64.00	2.00	2.00	1.777
2	<b>22713</b>	101.60	2.10	2.00	2.187
3	<b>22702</b>	101.60	3.00	2.50	2.664
4	<b>22714</b>	101.60	4.00	3.00	3.124

22711

0.434 kg/m

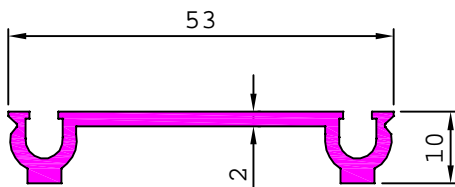

MATCHING WITH 22712

22712

0.343 kg/m

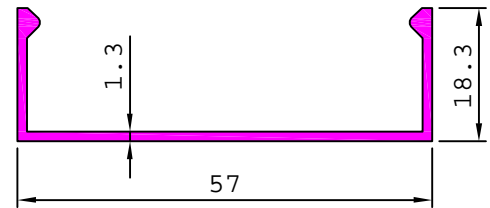

MATCHING WITH 22711

S6619

0.604 kg/m

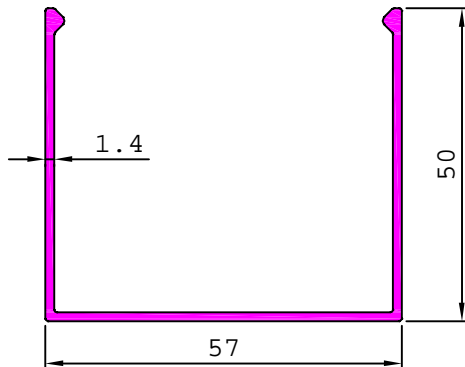

MATCHING WITH 22711

35865

0.350 kg/m

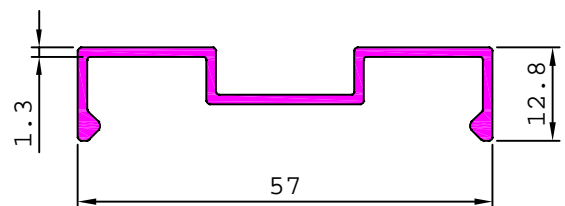

## CURTAIN WALL SECTION - 57 mm.

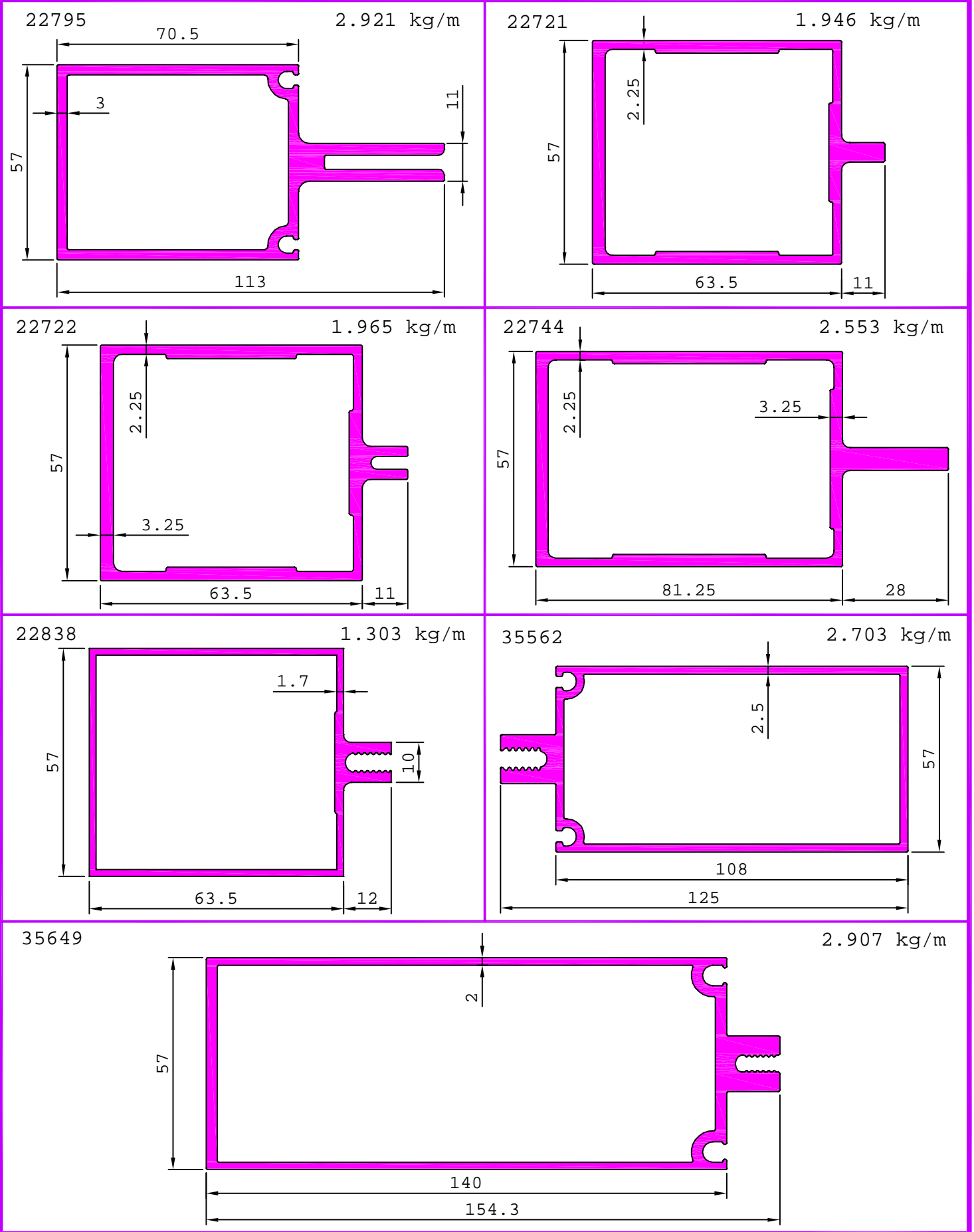

## CURTAIN WALL SECTION - 60 mm.

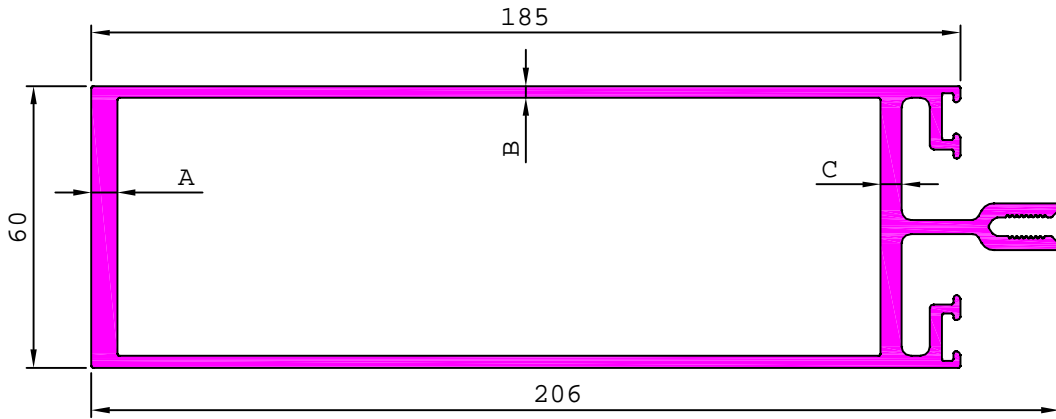

SL. No.	Section No.	A	B	C	Weight kg/m
1	<b>22822</b>	2.00	2.00	2.00	3.270
2	<b>22821</b>	5.50	2.50	4.50	4.616

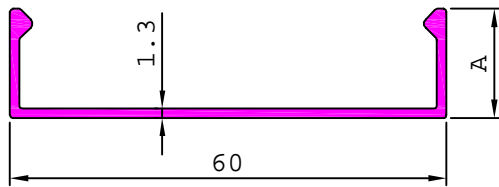

SL. No.	Section No.	A	Weight kg/m
1	<b>S6411</b>	12.00	0.309
2	<b>S6409</b>	15.00	0.330

S6410

0.420 kg/m

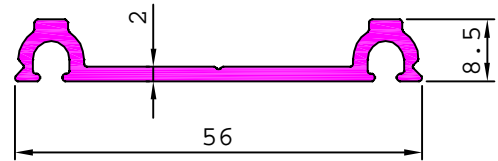

S5291

0.499 kg/m

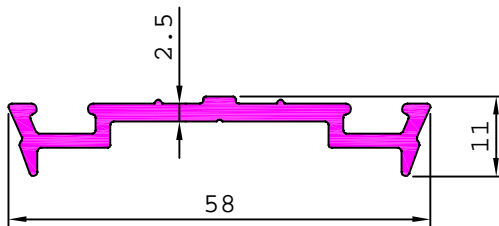

**MATCHING WITH 35534**

### CURTAIN WALL SECTION - 60 mm.

S5807

2.490 kg/m

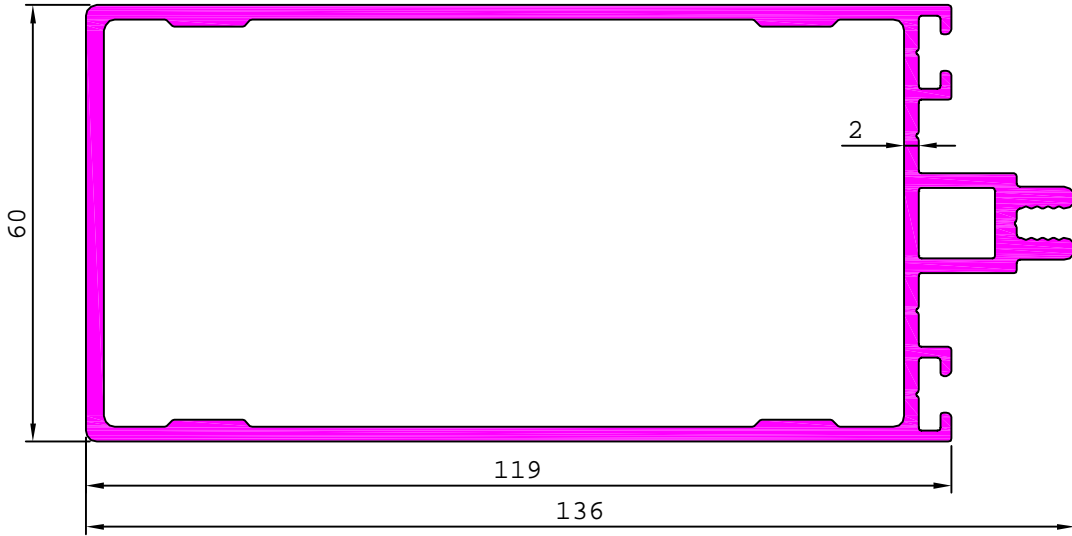

S6107

2.894 kg/m

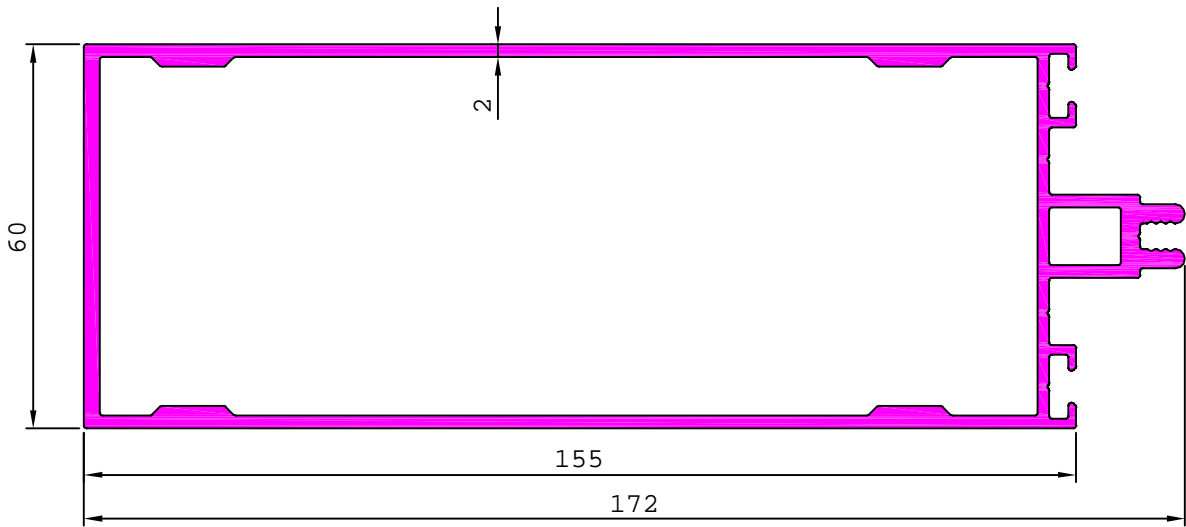

S6156

2.375 kg/m

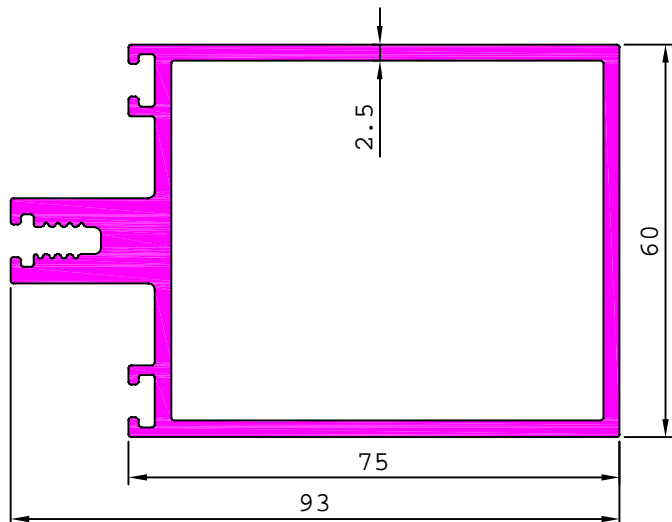

35535

1.754 kg/m

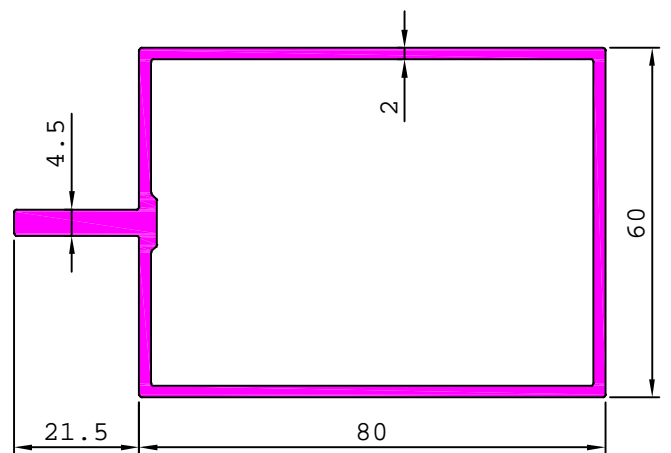

## CURTAIN WALL SECTION - 60 mm.

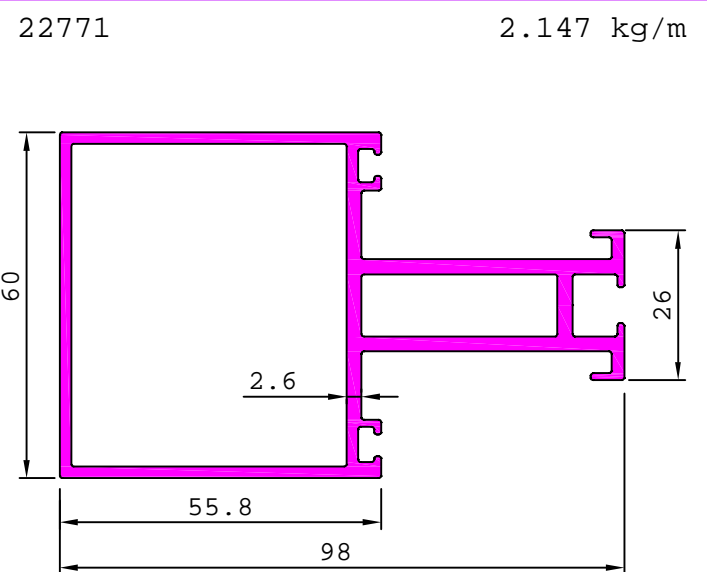
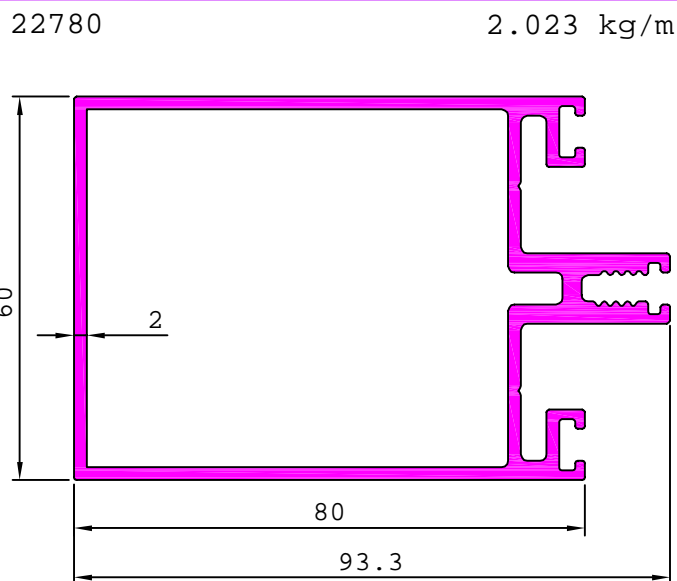
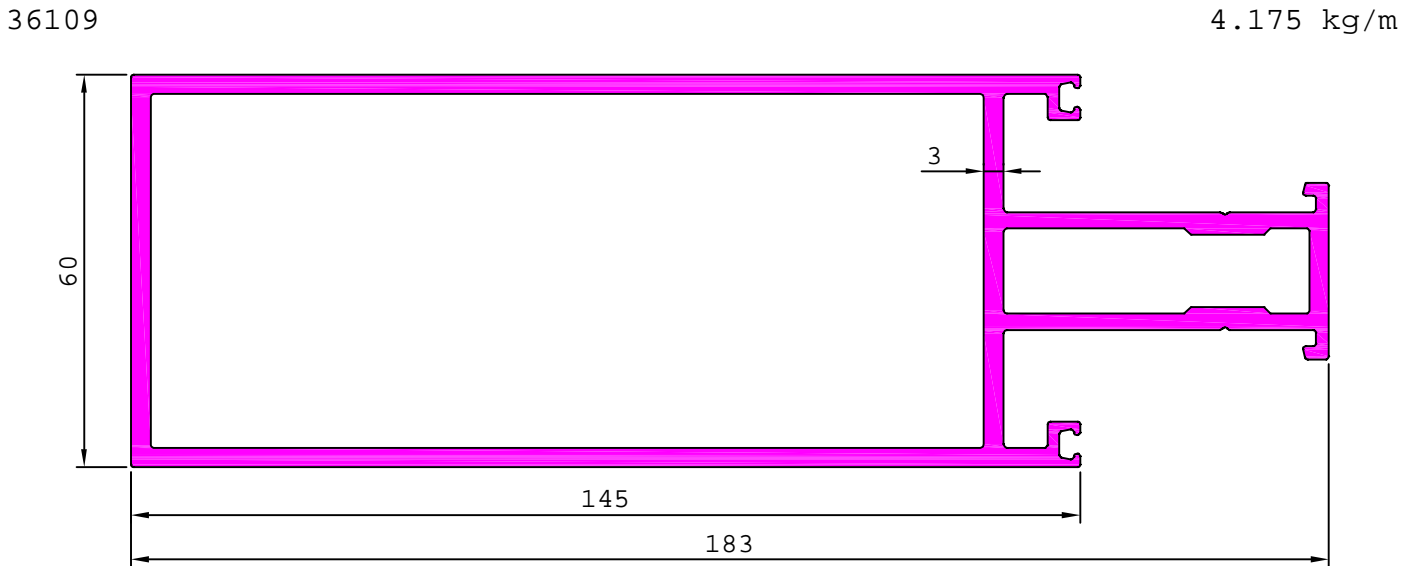
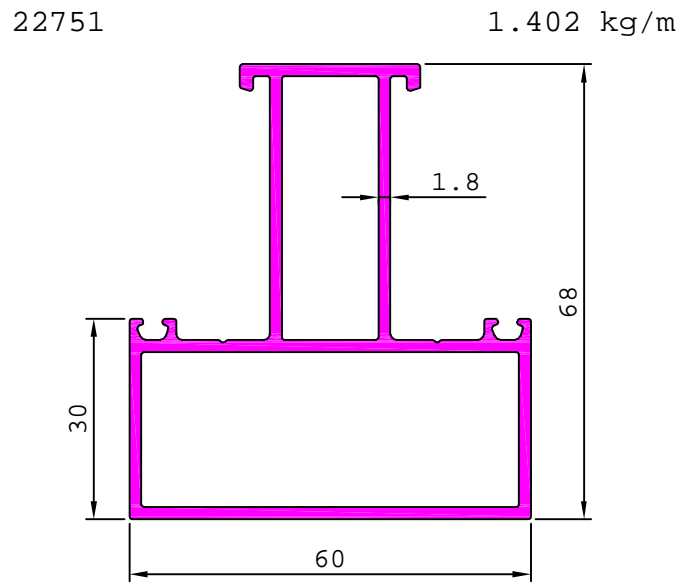
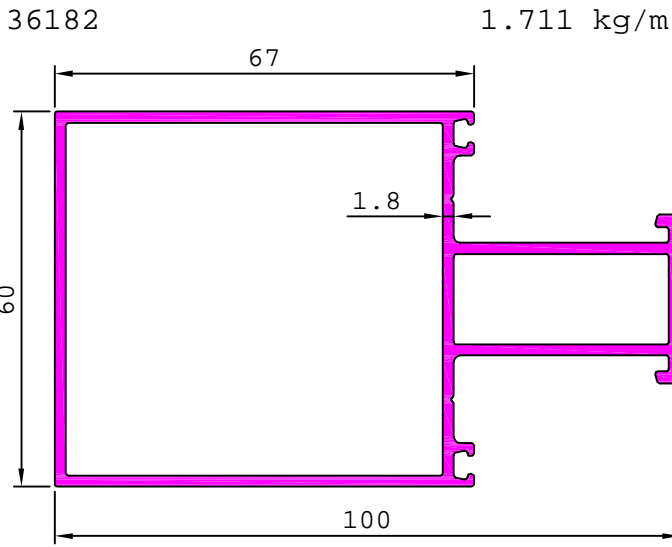

## CURTAIN WALL SECTION - 60 mm.

36110

1.043 kg/m

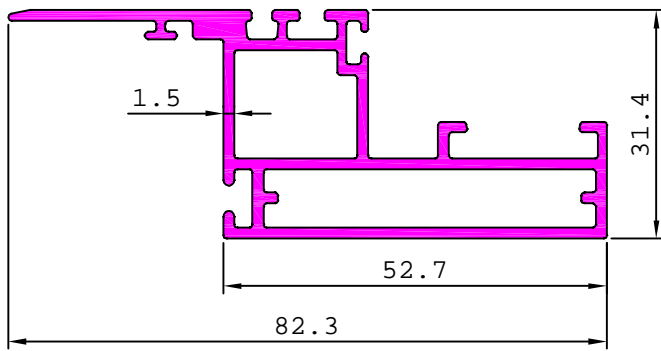

35983

1.875 kg/m

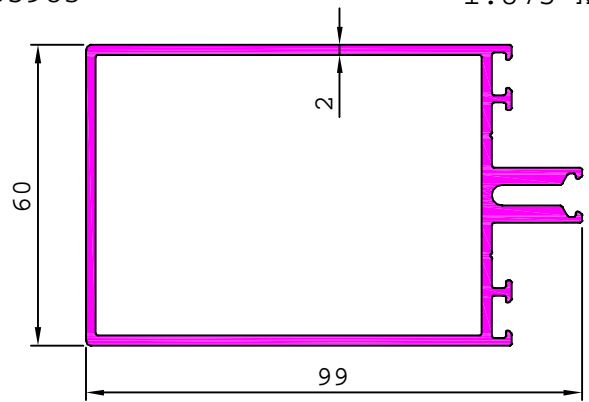

22781

4.125 kg/m

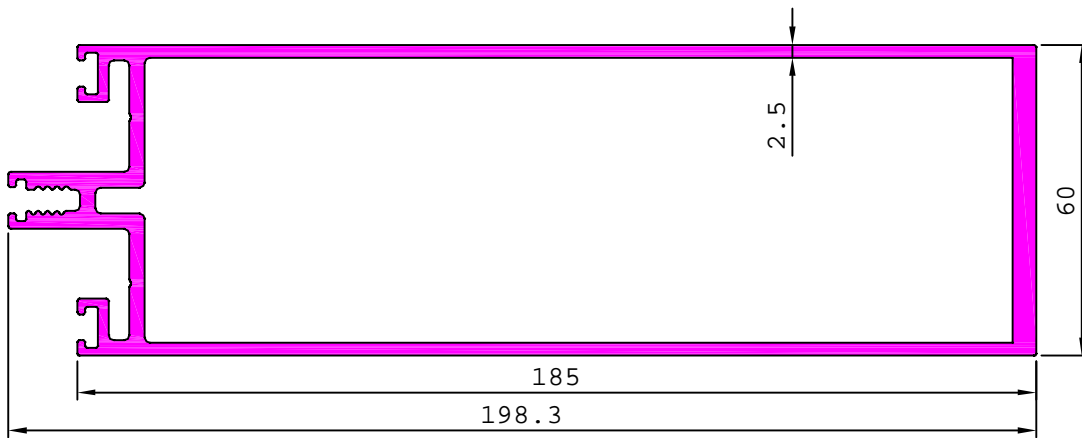

22802

3.138 kg/m

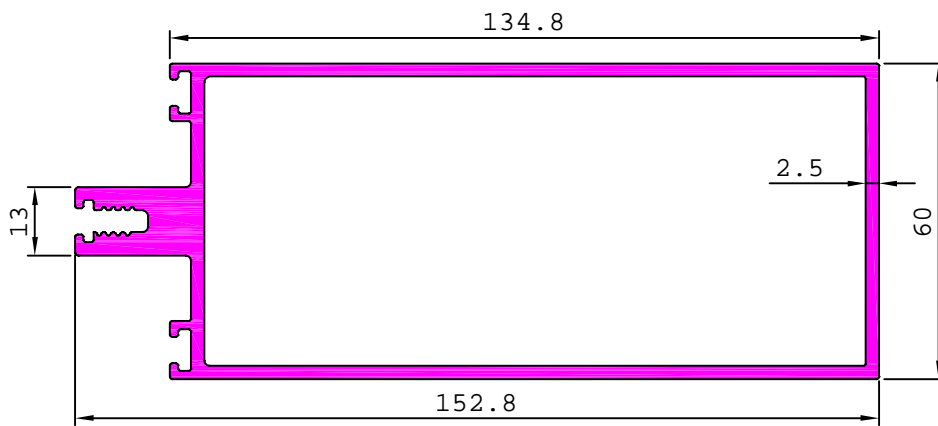

22803

4.208 kg/m

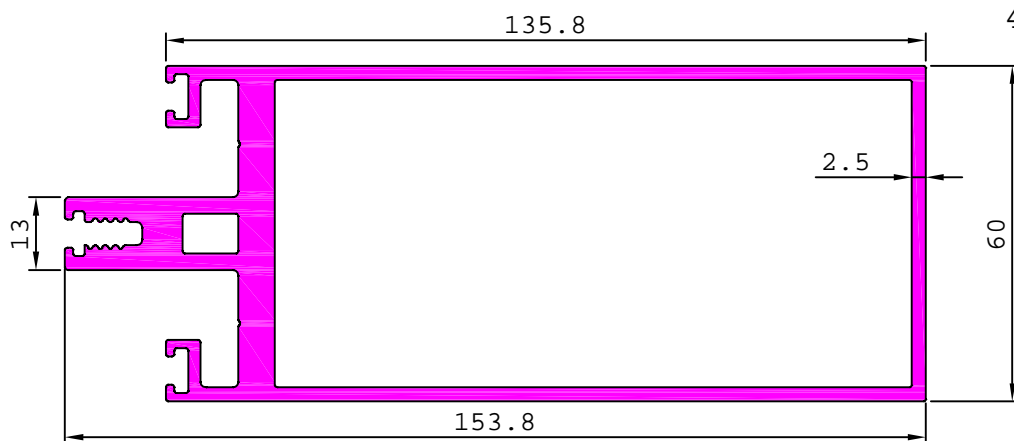

## CURTAIN WALL SECTION - 60 mm.

22804

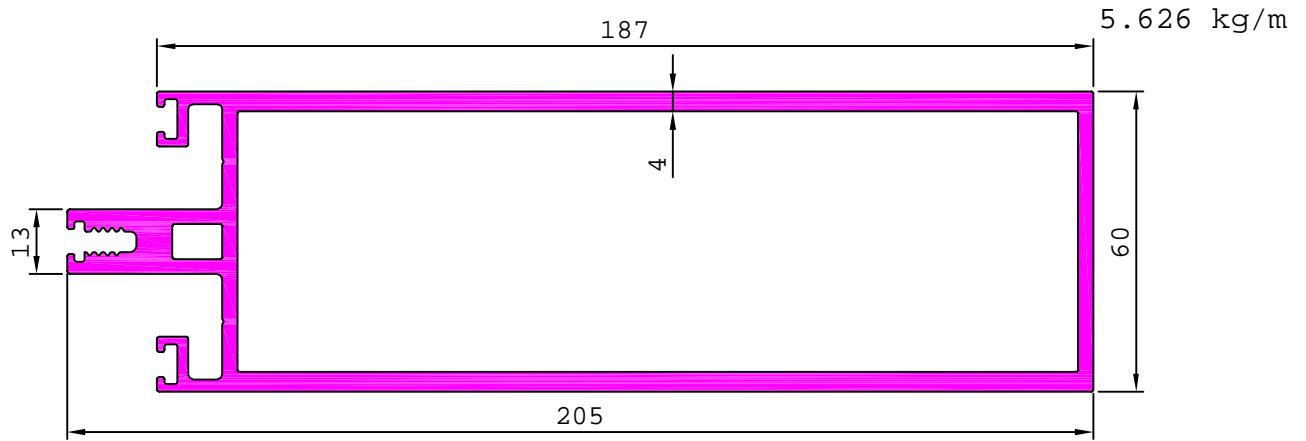

22805

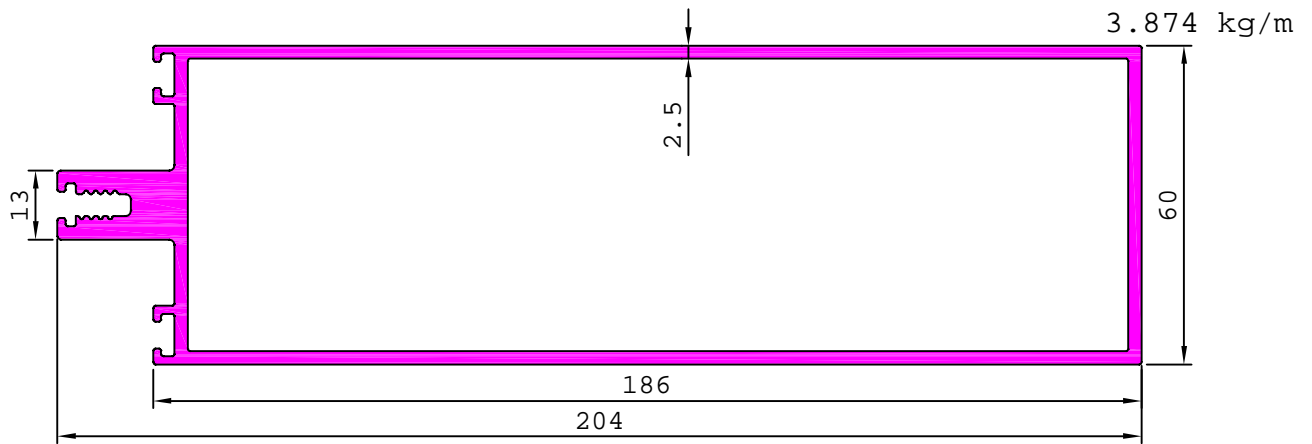

22813

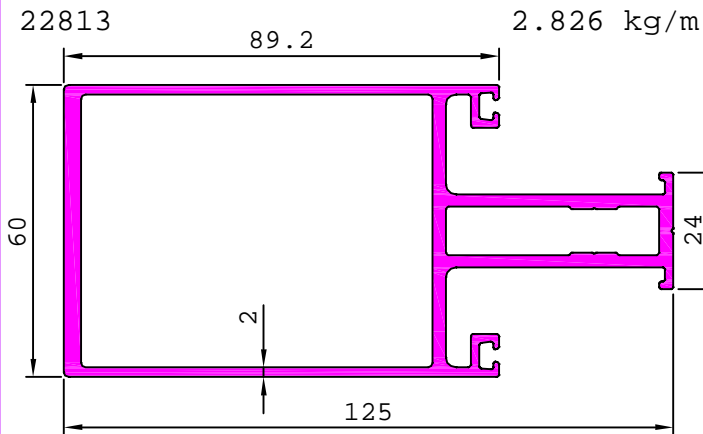

22814

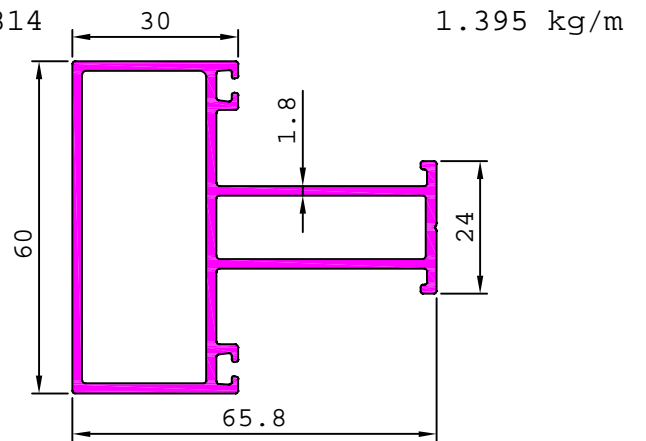

22815

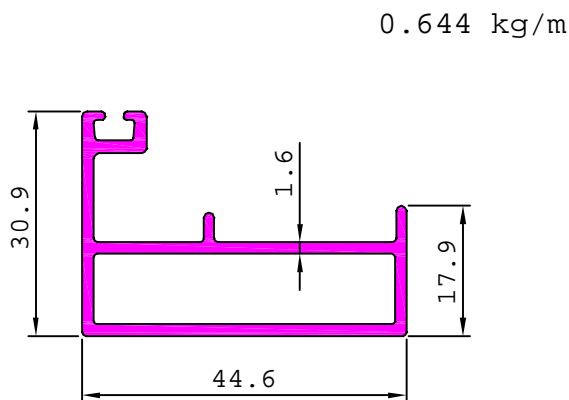

22847

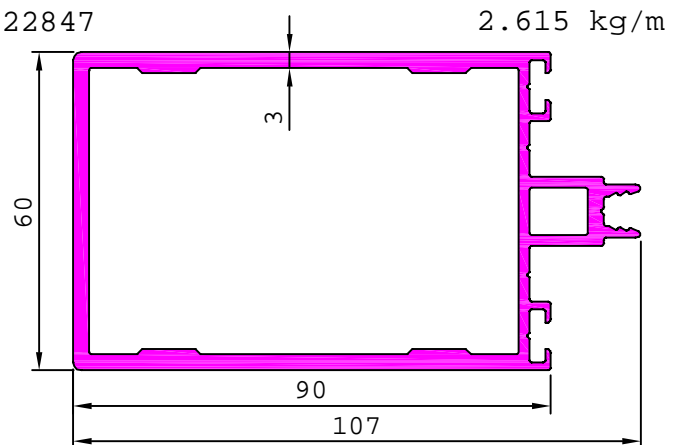

## CURTAIN WALL SECTION - 60 mm.

22743

2.359 kg/m

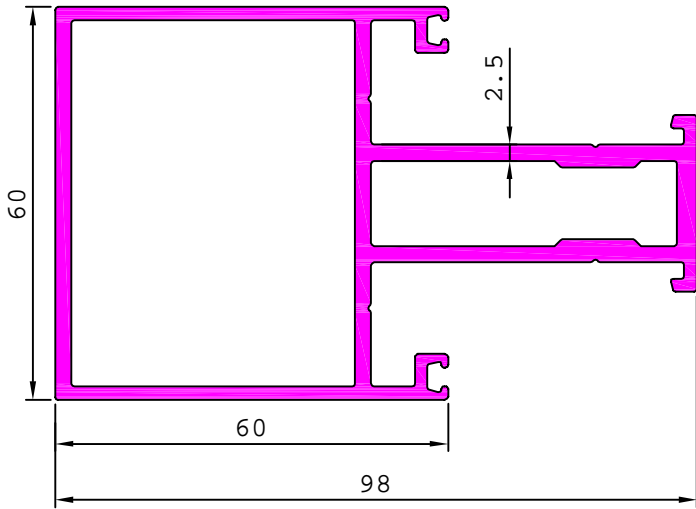

22832

1.711 kg/m

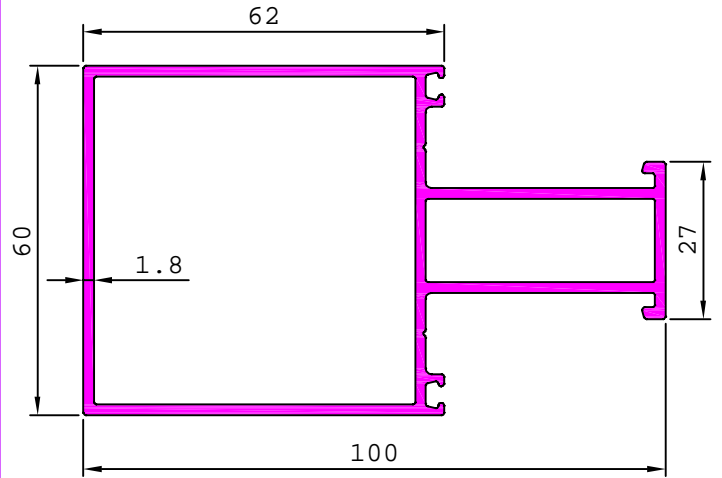

22833

3.300 kg/m

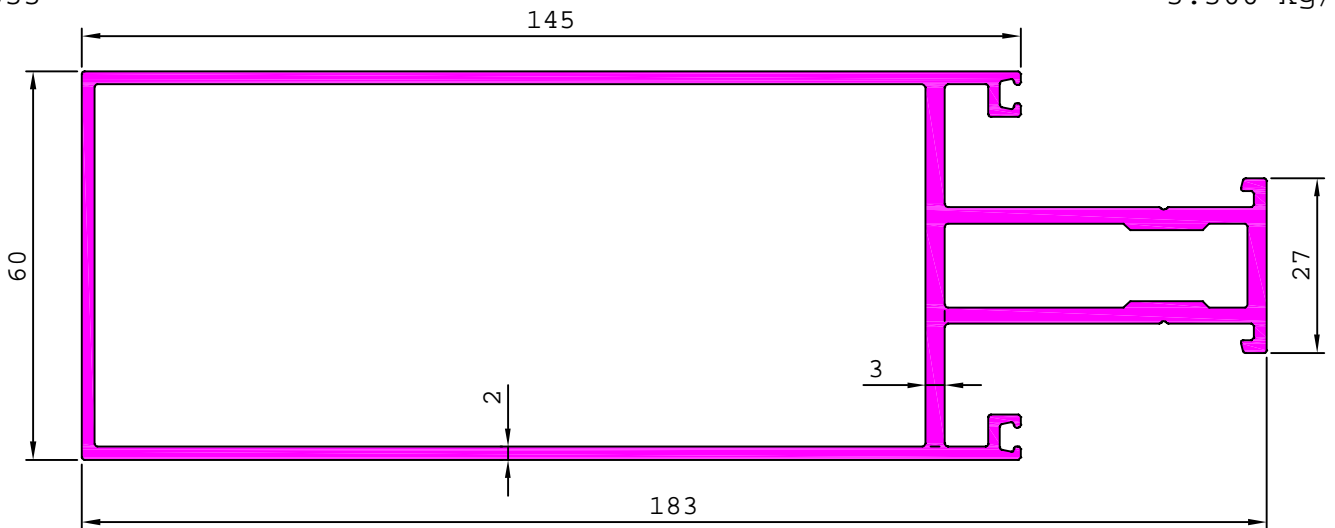

35516

1.946 kg/m

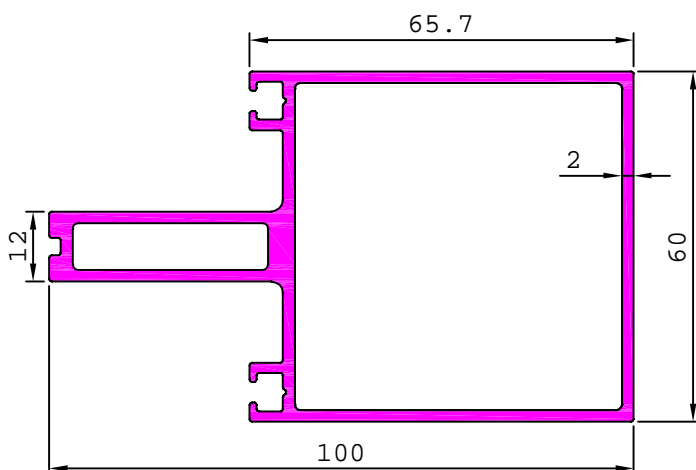

35820

0.776 kg/m

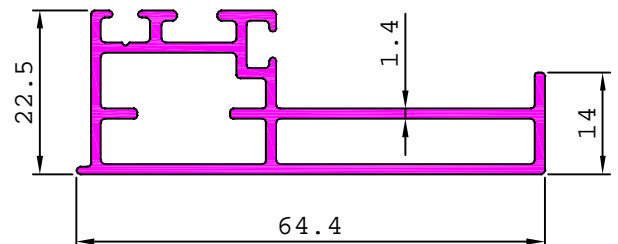

## CURTAIN WALL SECTION - 60 mm.

35853

3.949 kg/m

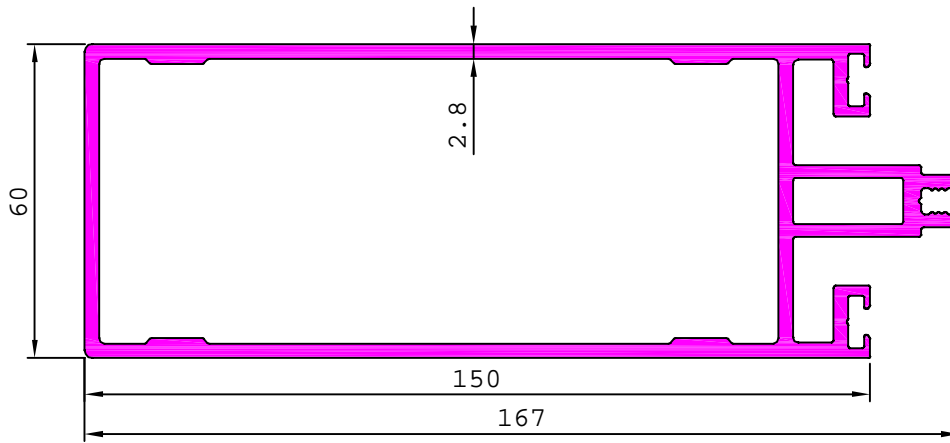

35527

1.697 kg/m

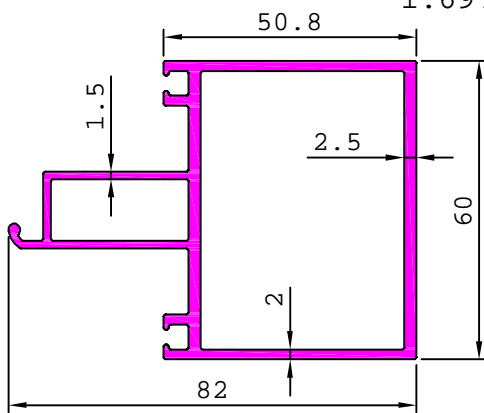

35528

1.281 kg/m

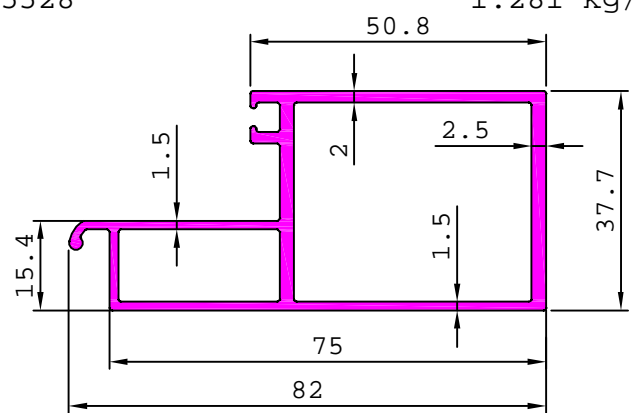

35529

0.602 kg/m

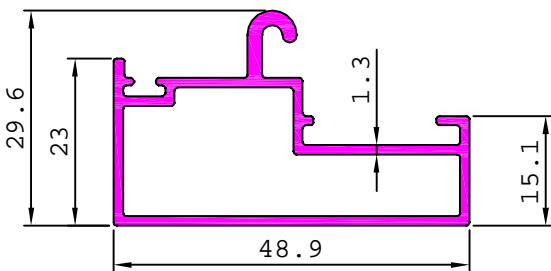

35530

0.550 kg/m

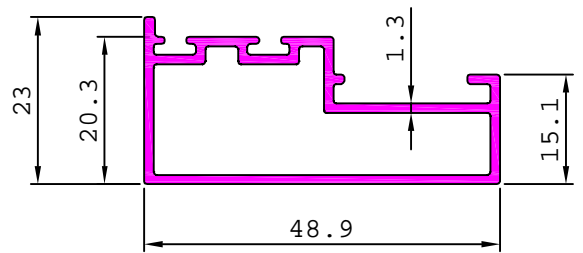

35693

0.563 kg/m

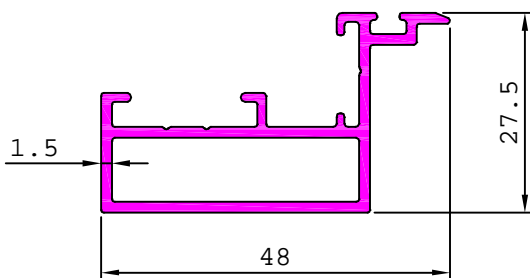

35705

0.541 kg/m

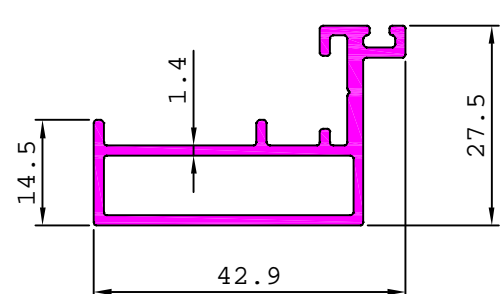

## CURTAIN WALL SECTION - 60 mm.

35525

2.612 kg/m

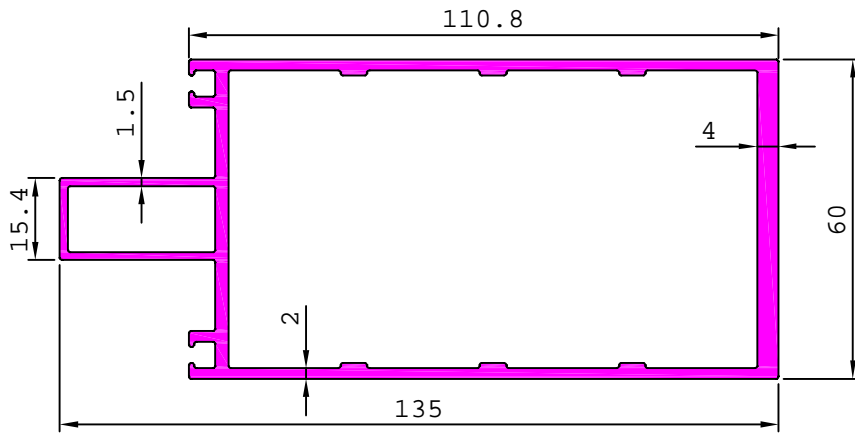

35526

1.987 kg/m

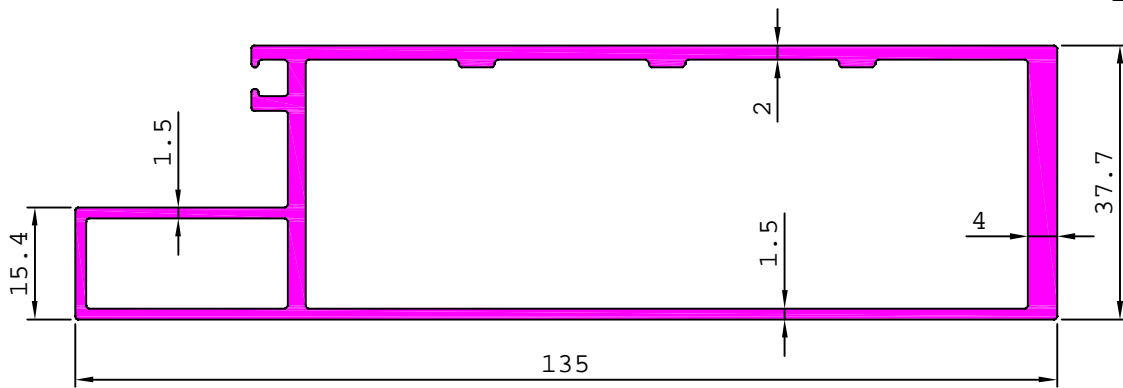

35533

4.957 kg/m

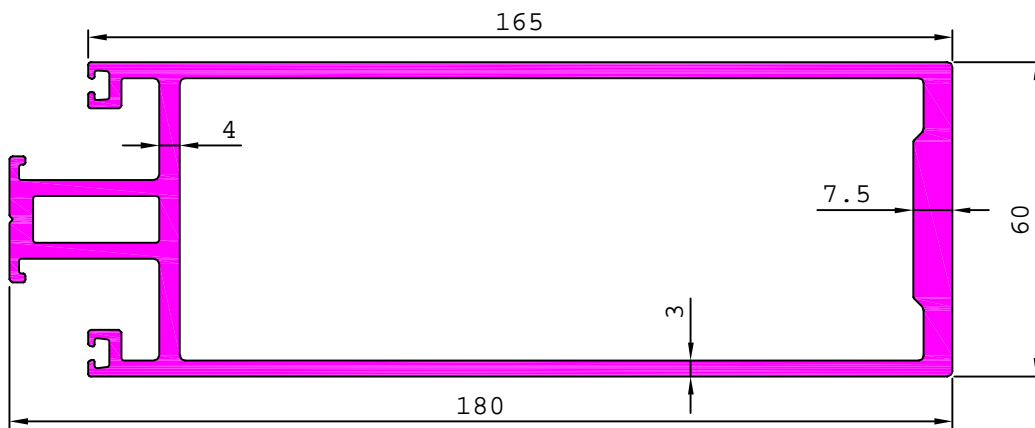

35534

1.587 kg/m

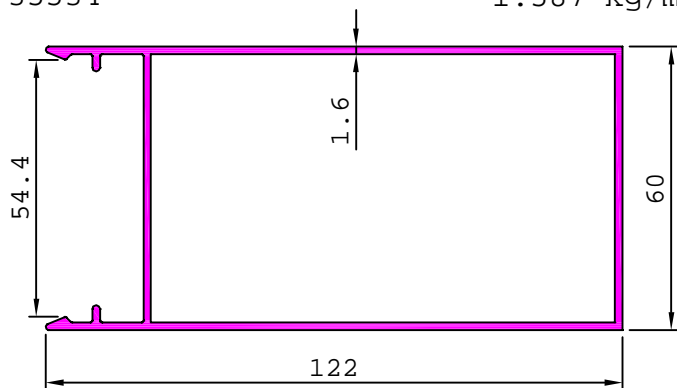

MATCHING WITH S5291

35572

1.707 kg/m

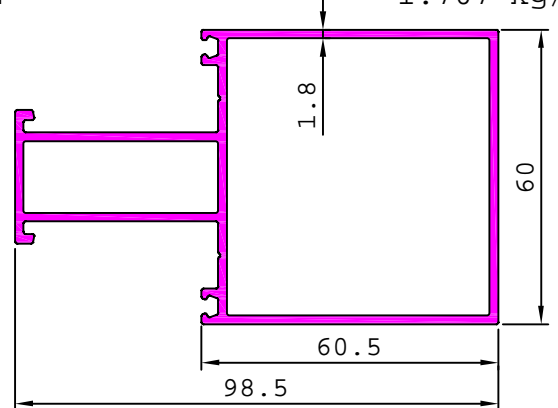

# CURTAIN WALL SECTION - 60 mm.

35694

3.606 kg/m

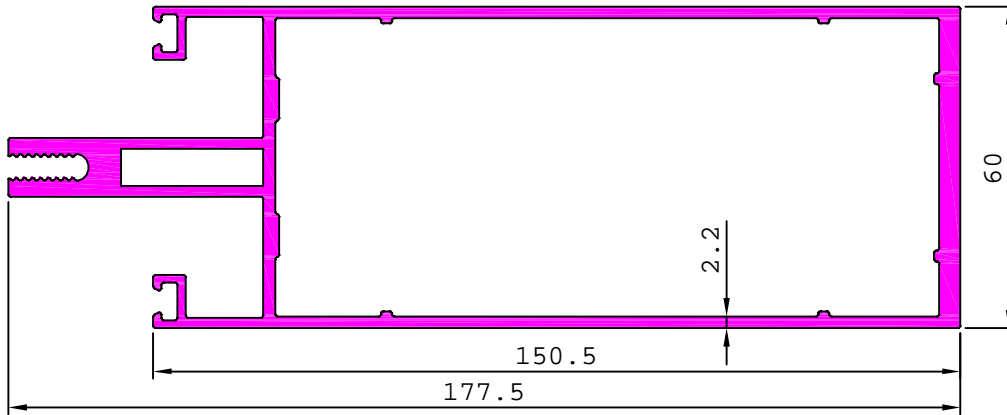

35708

2.298 kg/m

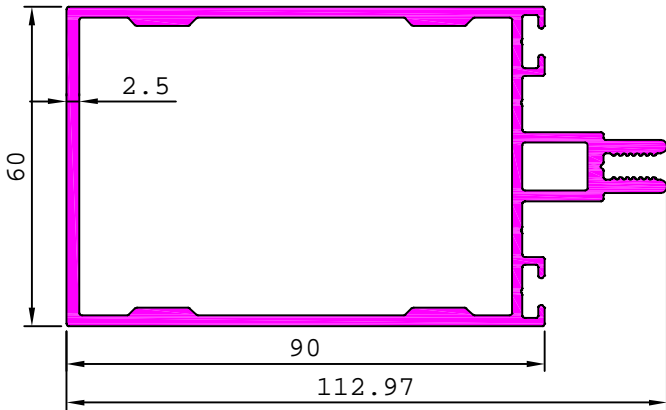

35748

2.239 kg/m

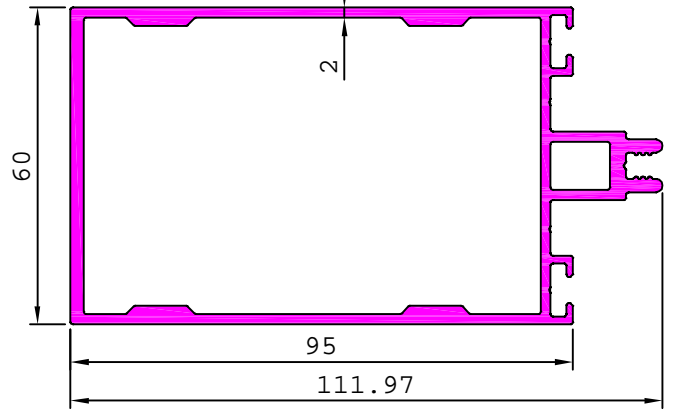

35822

1.902 kg/m

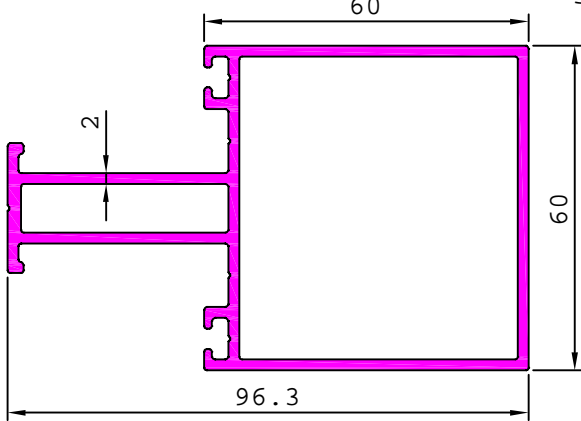

35802

2.421 kg/m

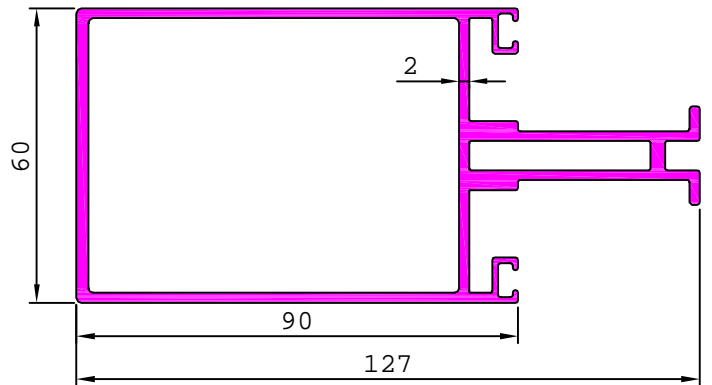

35541

3.619 kg/m

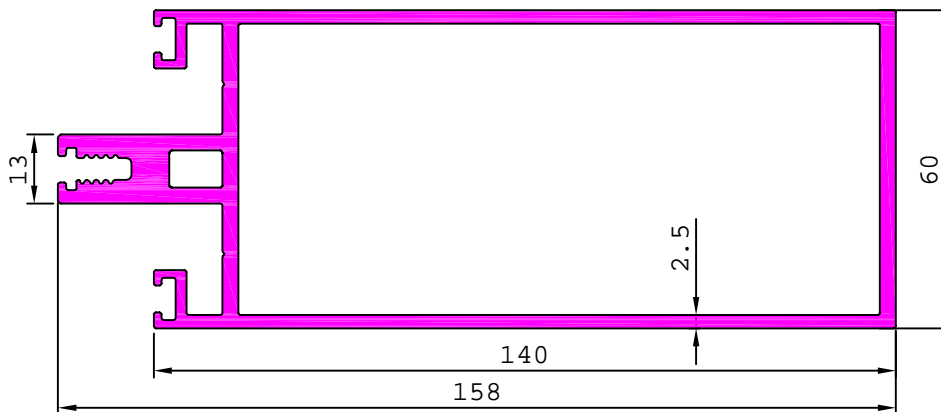

## CURTAIN WALL SECTION - 60 mm.

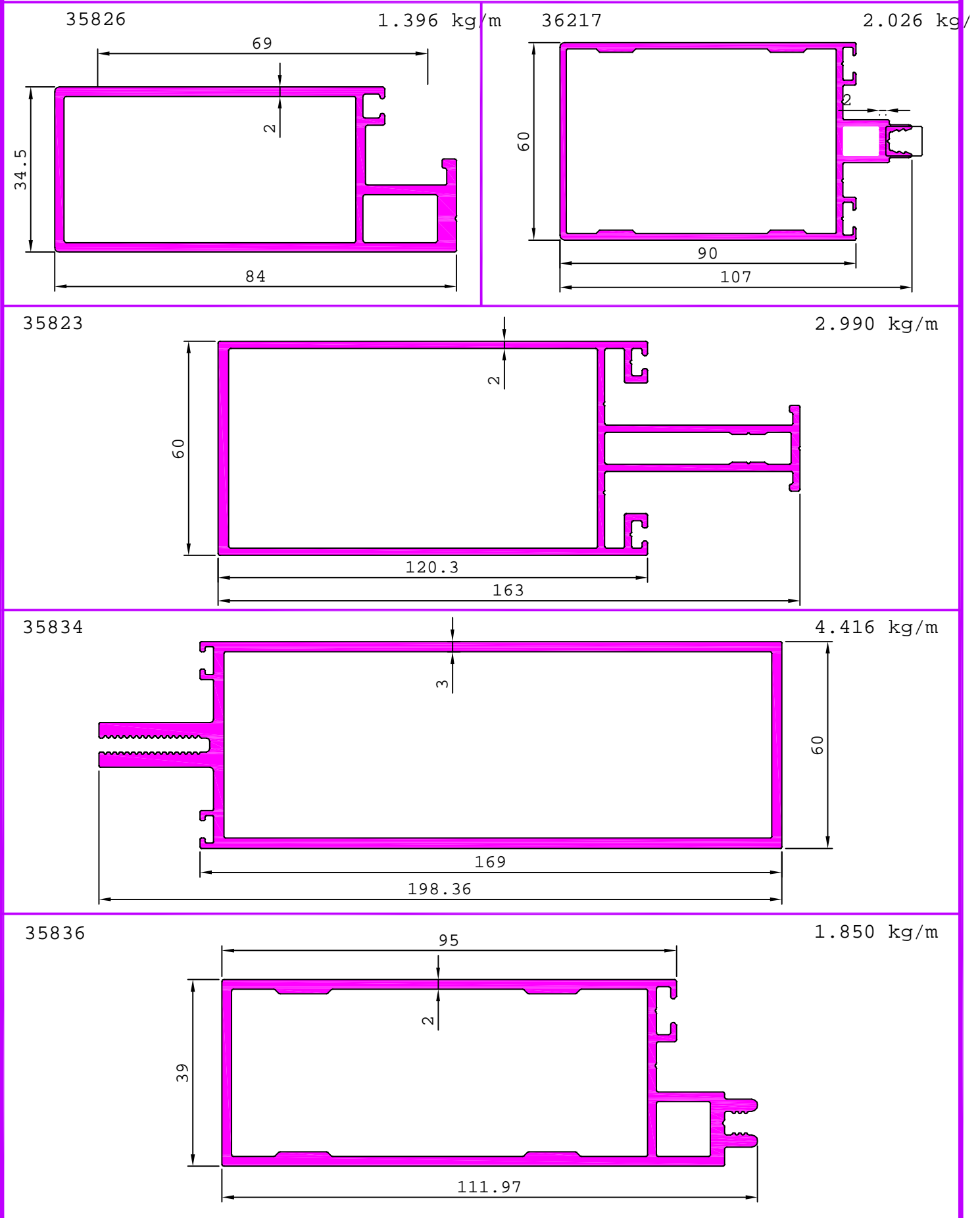

**CURTAIN WALL SECTION - 60 mm.**

35837

0.756 kg/m

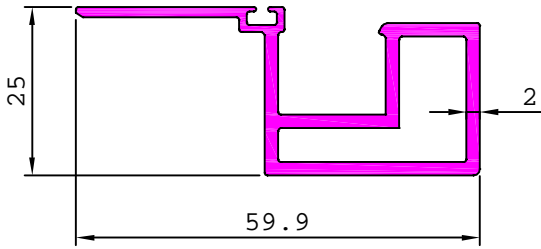

S4756

3.593 kg/m

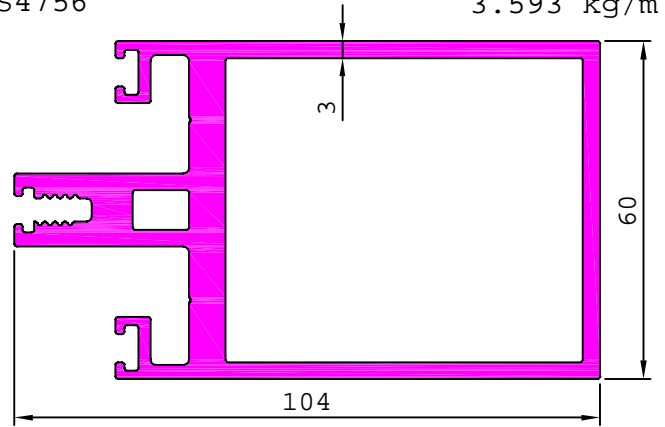

35868

3.708 kg/m

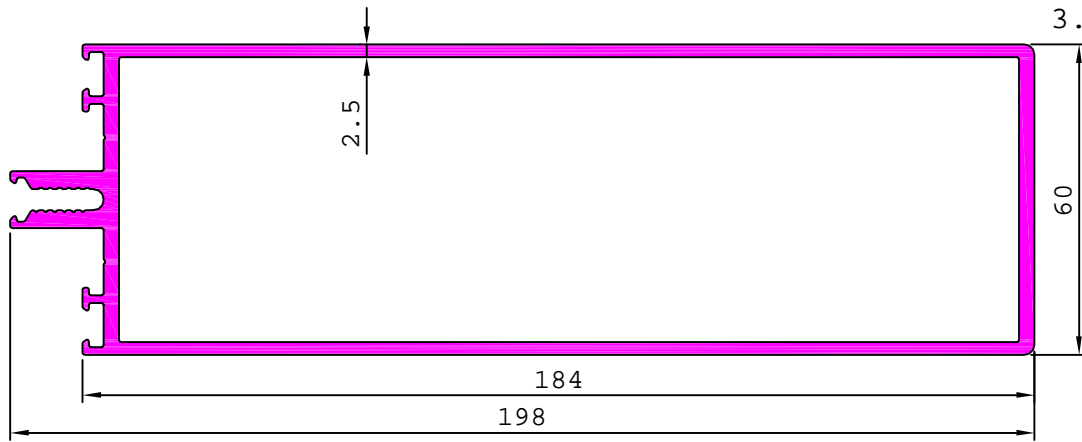

36153

1.341 kg/m

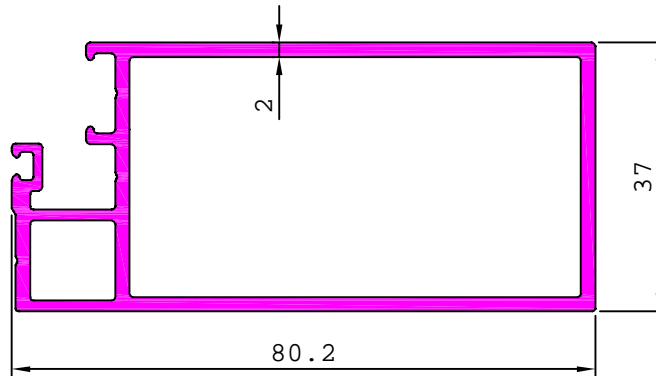

S5805

3.078 kg/m

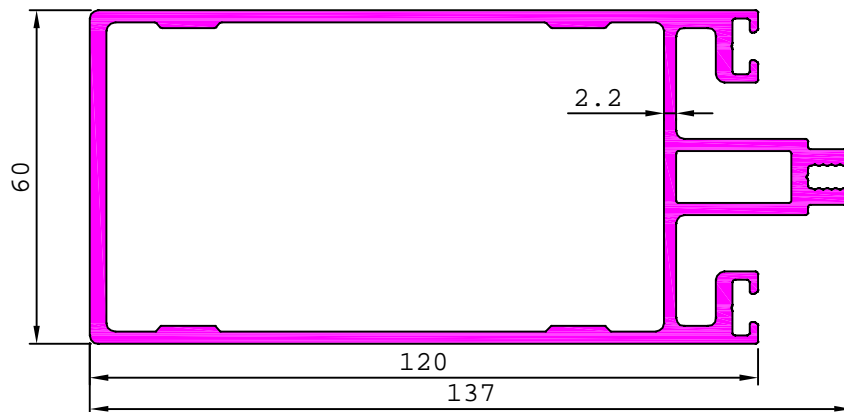

**CURTAIN WALL SECTION - 60 mm.**

S6412

3.436 kg/m

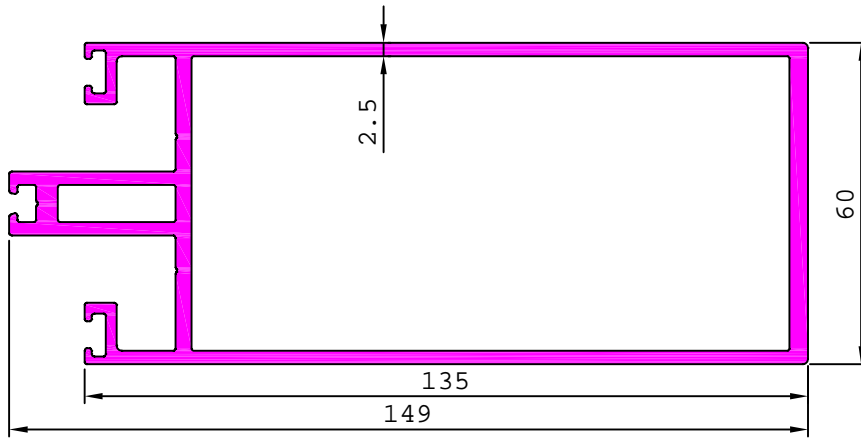

S6413

2.293 kg/m

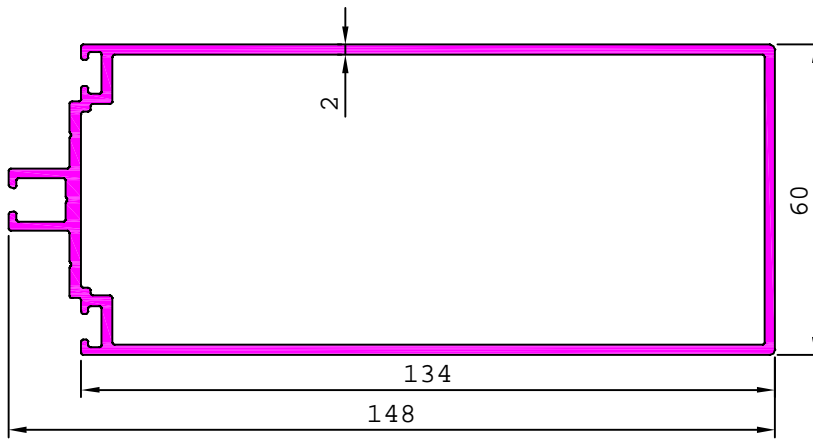

36134

4.599 kg/m

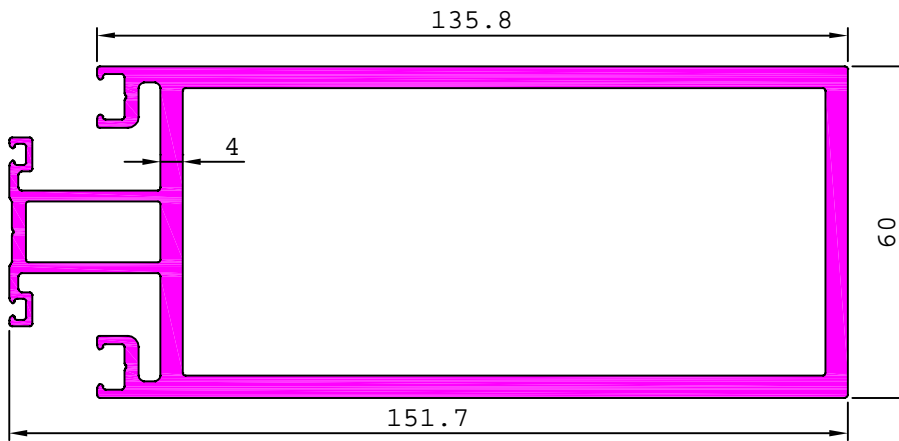

36152

2.179 kg/m

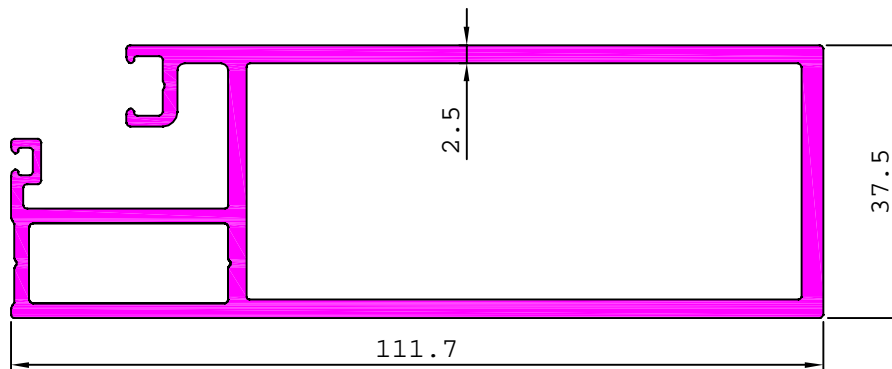

### CURTAIN WALL SECTION - 60 mm.

29161

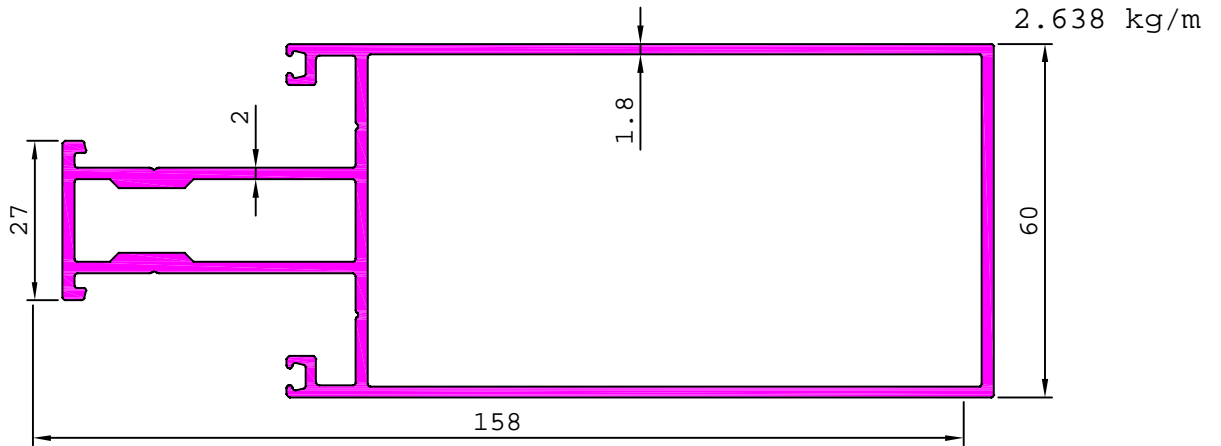

36164

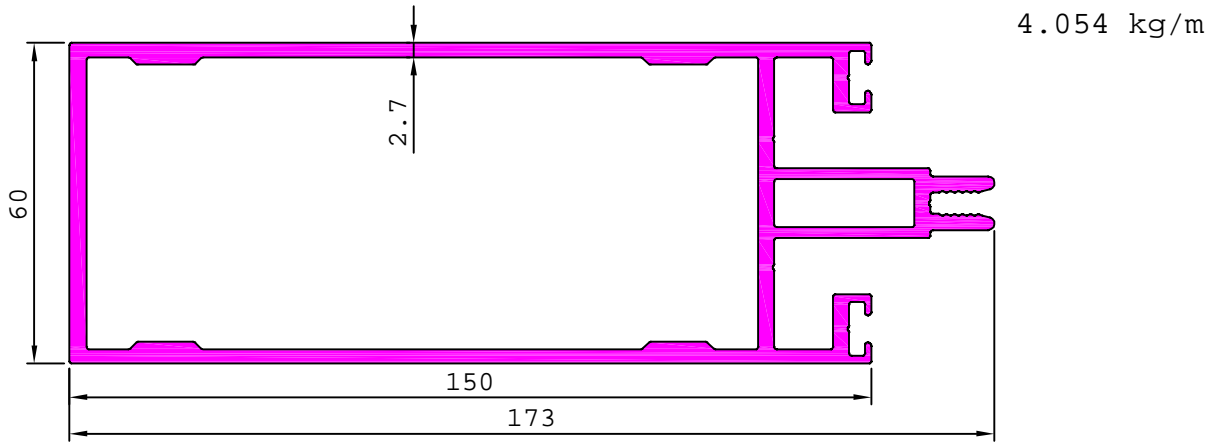

S6781

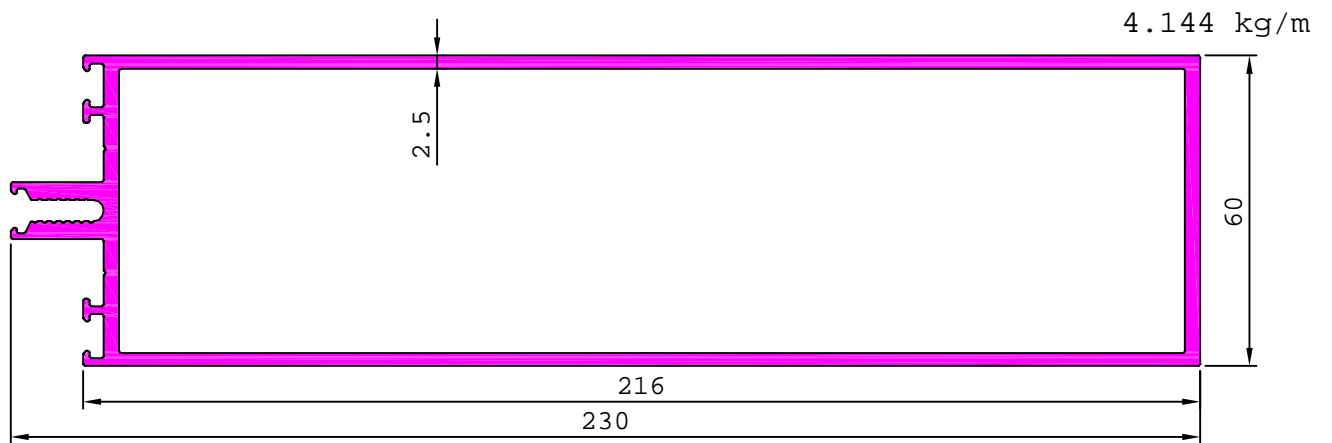

S6782

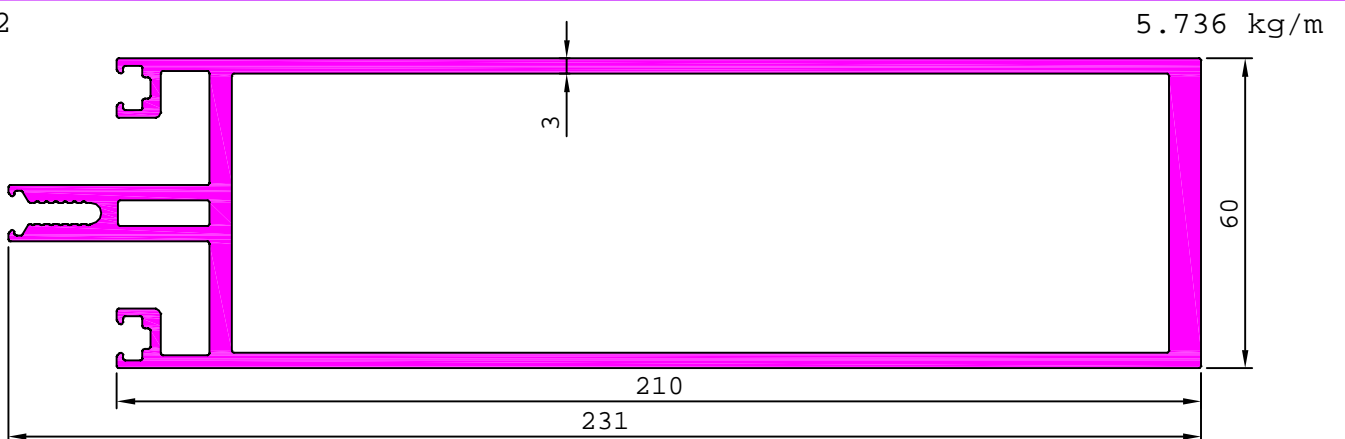

### CURTAIN WALL SECTION - 60 mm.

36210

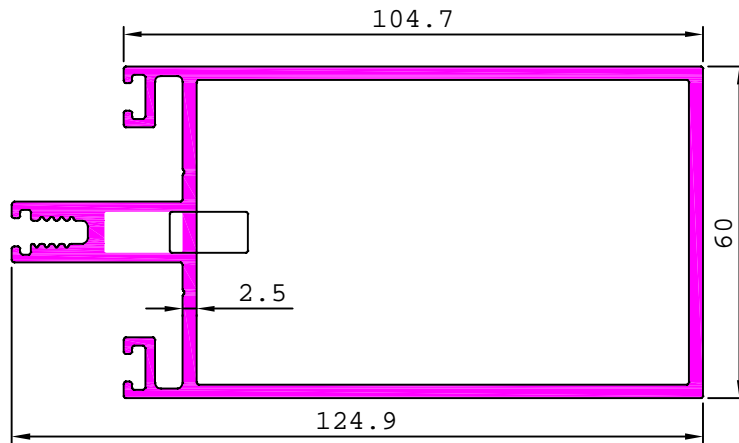

2.698 kg/m

36211

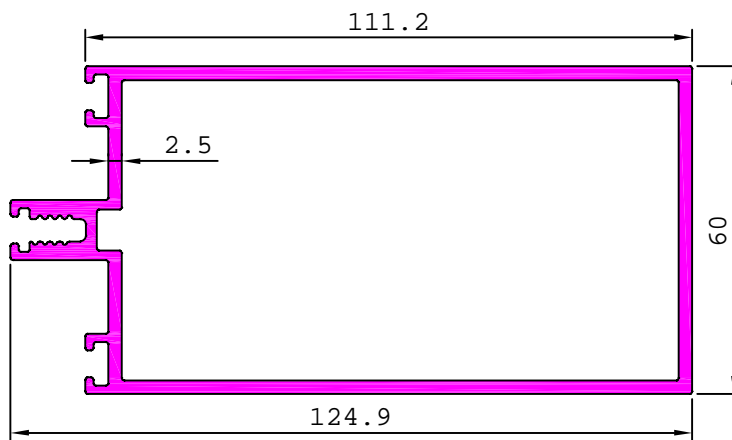

2.530 kg/m

36212

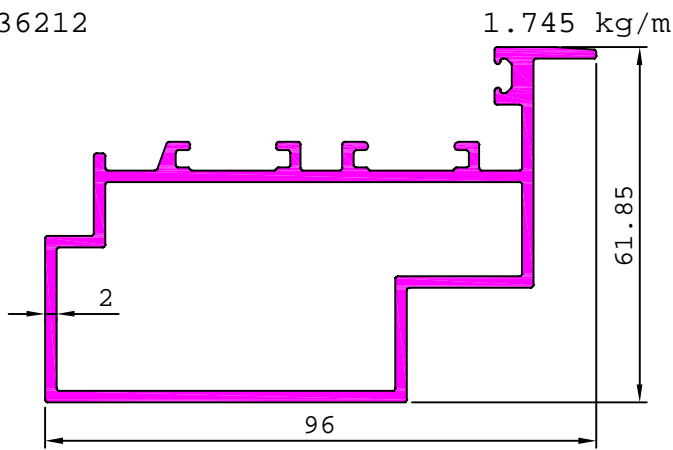

1.745 kg/m

36213

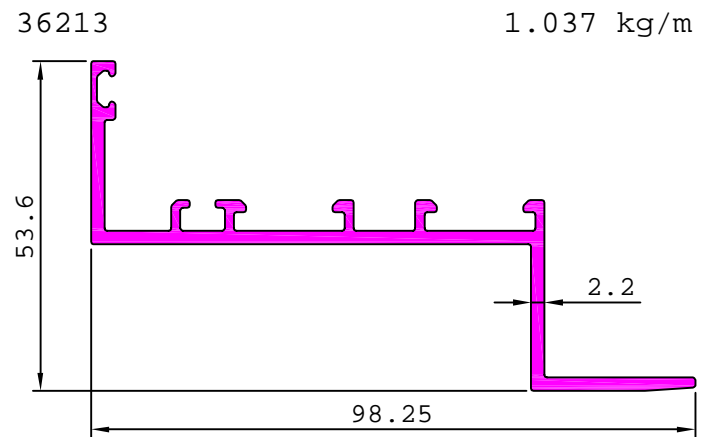

1.037 kg/m

36080

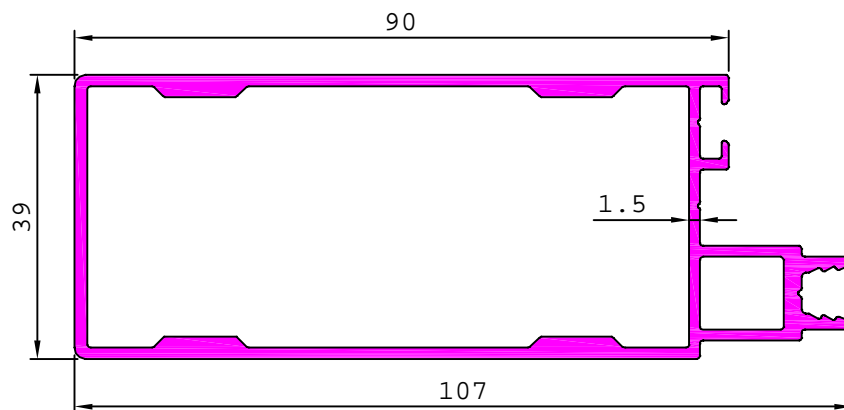

1.490 kg/m

### CURTAIN WALL SECTION - 60 mm.

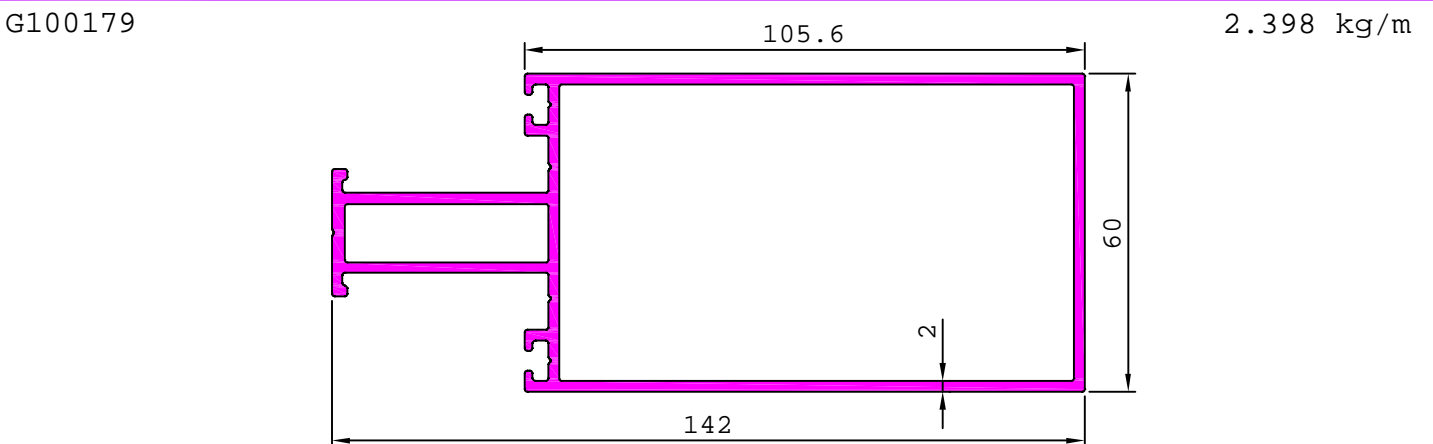
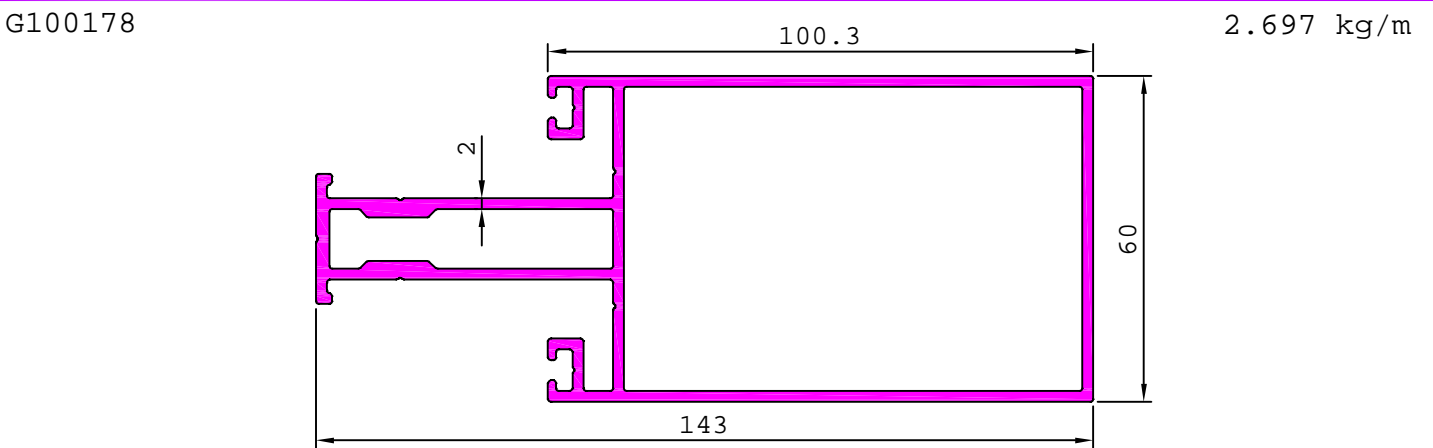
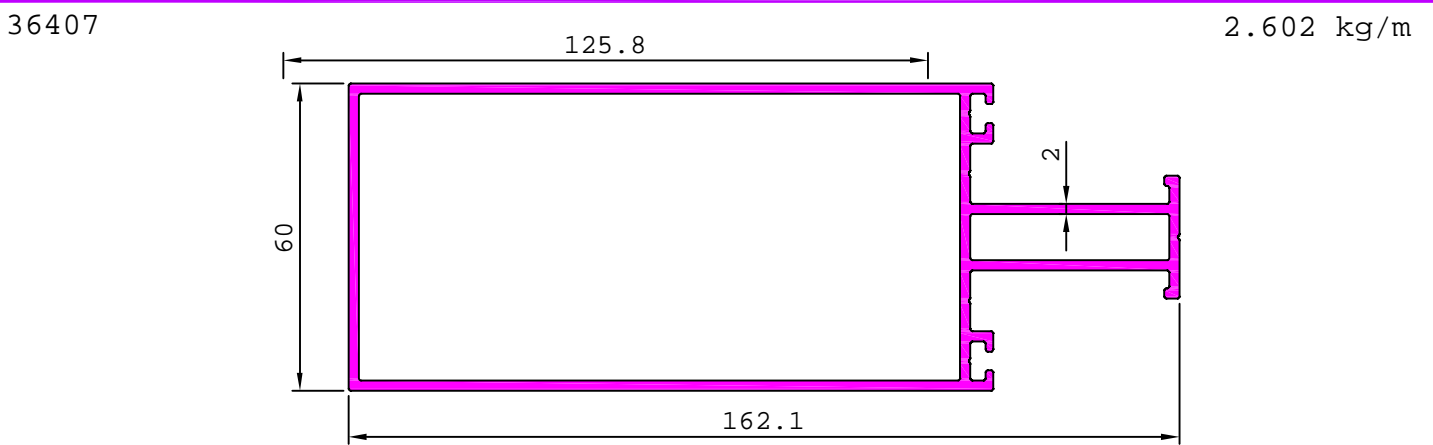
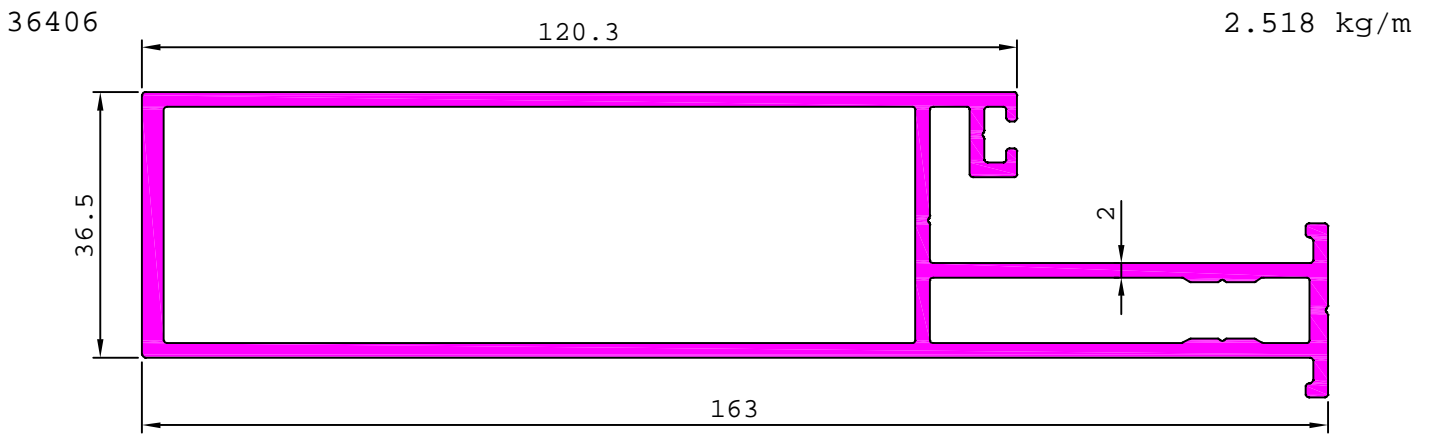

## CURTAIN WALL SECTION - 60 mm.

G100593

4.435 kg/m

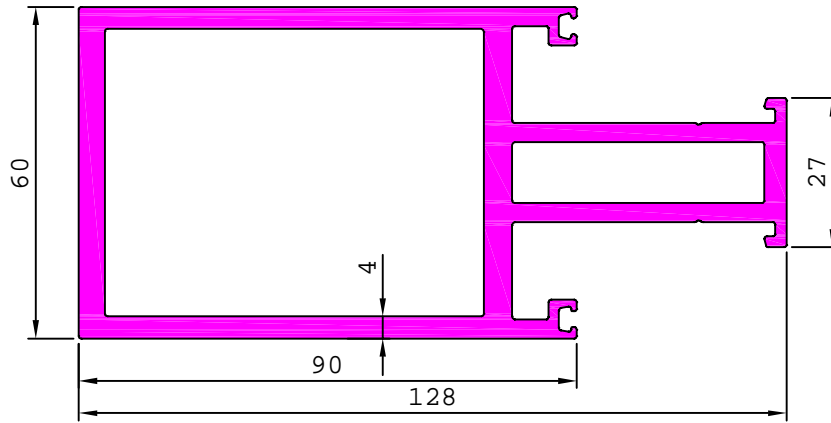

G100594

2.596 kg/m

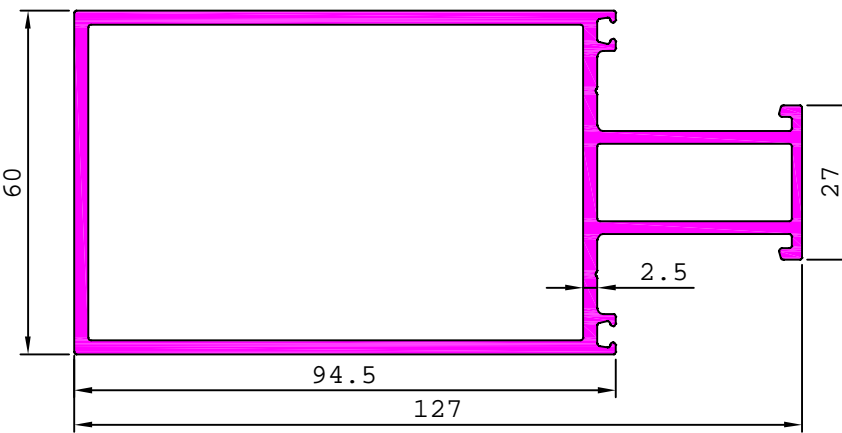

G100729

5.925 kg/m

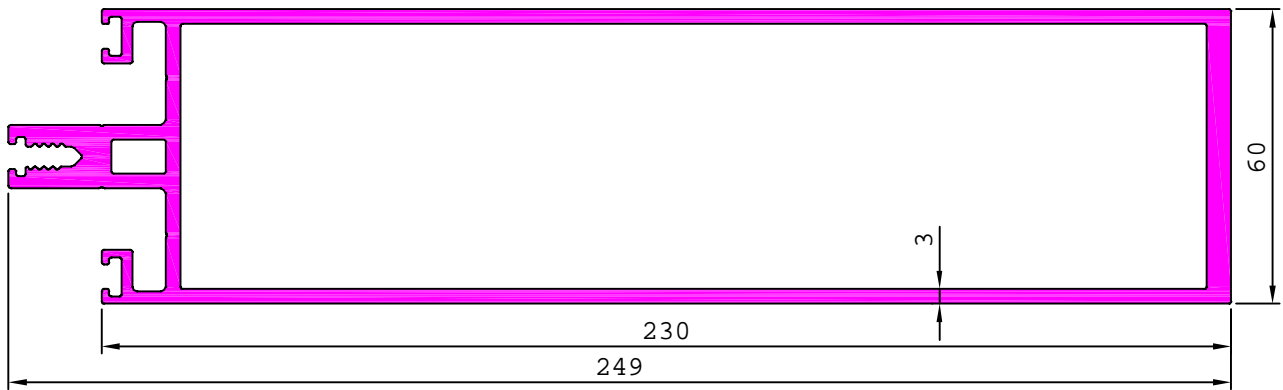

G100730

0.389 kg/m

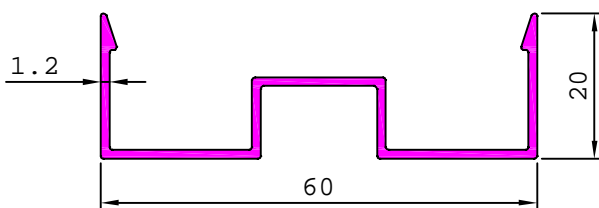

### CURTAIN WALL SECTION - 60 mm.

36205

2.723 kg/m

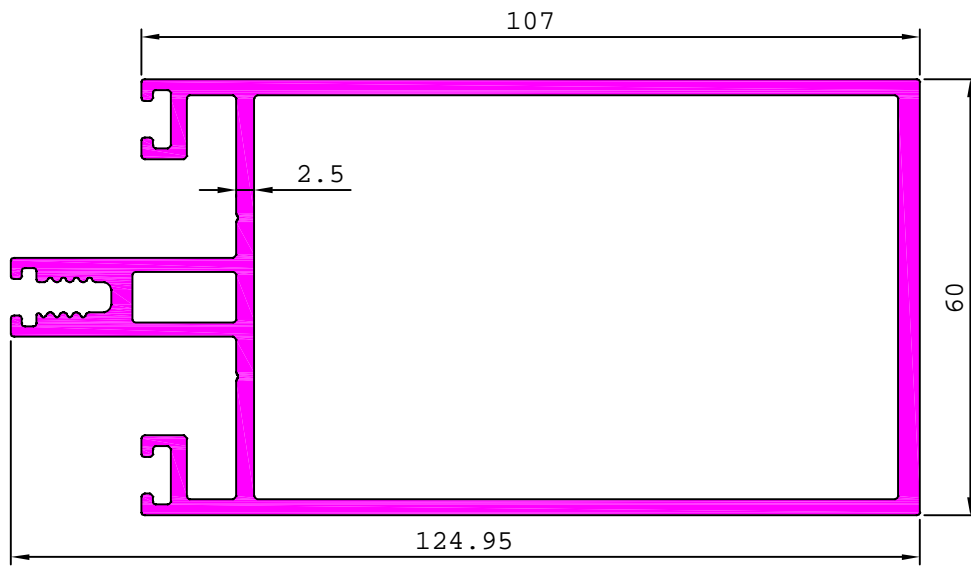

G102601

3.177 kg/m

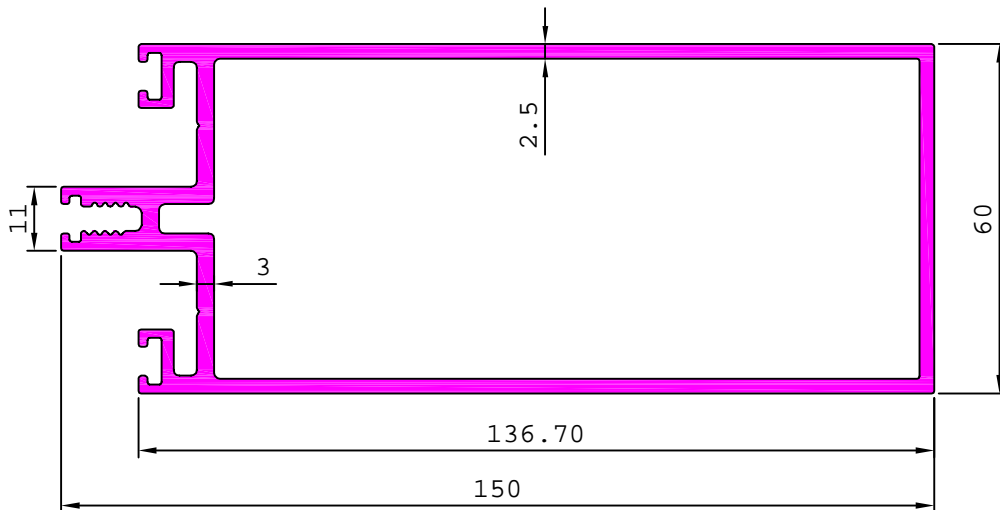

## CURTAIN WALL SECTION - 61.5 mm.

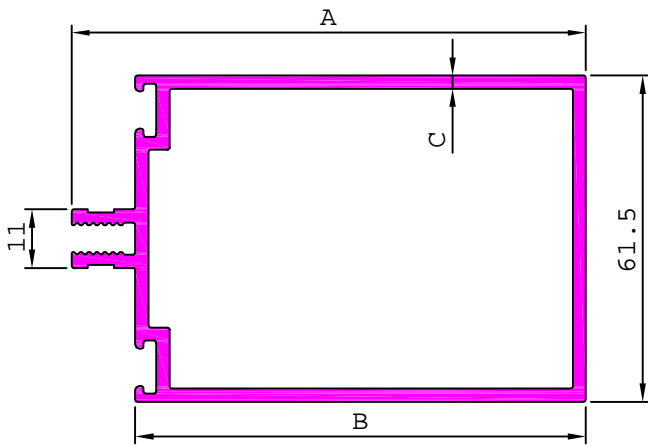

SL No	SECTION No	A	B	C	WEIGHT kg/m
1	<b>35505</b>	82.00	70.00	2.00	1.595
2	<b>35506</b>	97.00	85.00	2.50	2.128

22707

0.395 kg/m

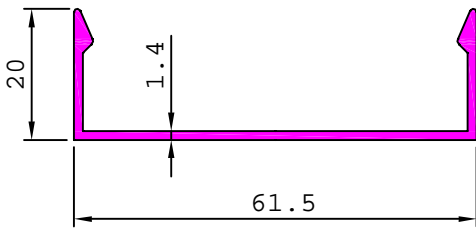

22709

0.536 kg/m

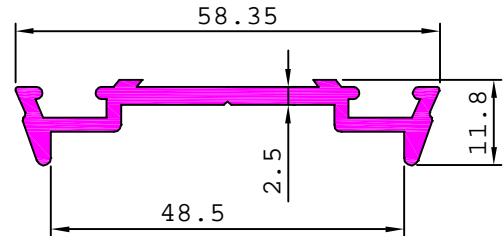

35972

3.373 kg/m

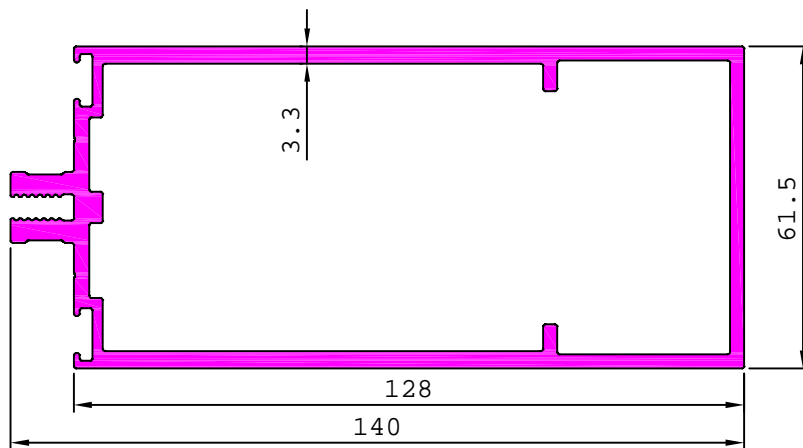

35973

0.398 kg/m

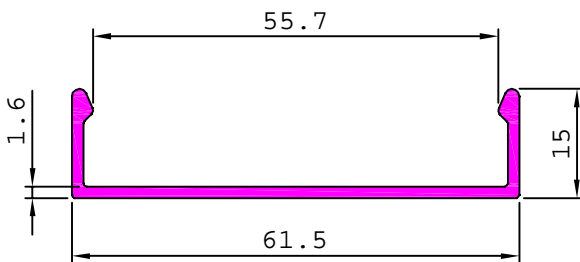

22710

2.166 kg/m

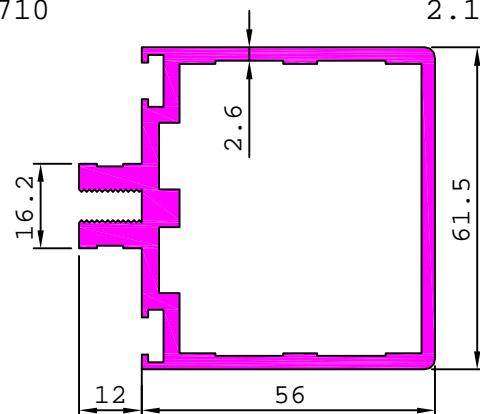

## CURTAIN WALL SECTION - 61.5 mm.

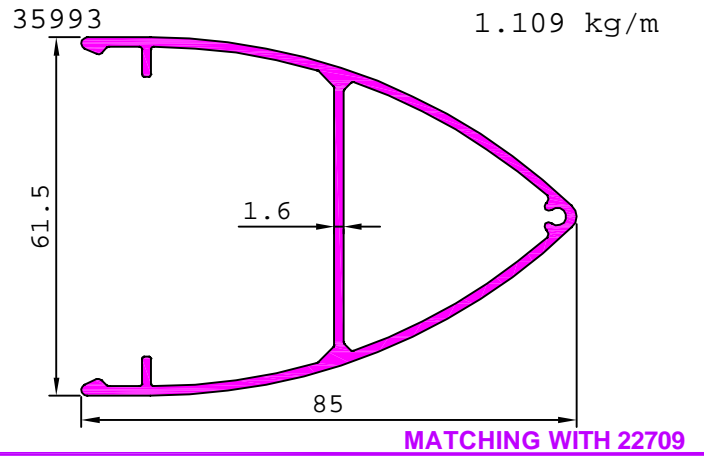
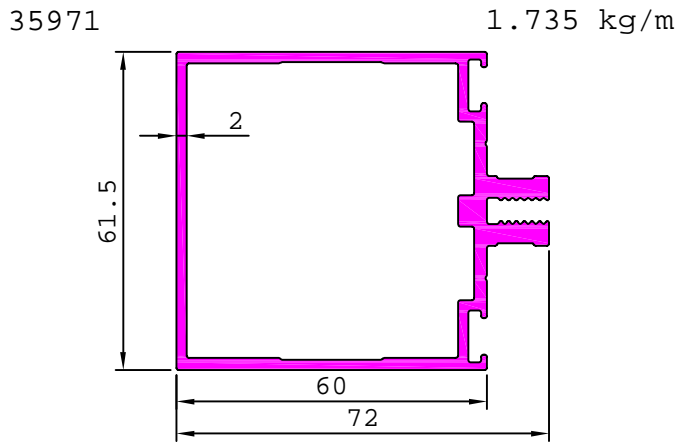

**CURTAIN WALL SECTION - 63 mm.**

35646

2.447 kg/m

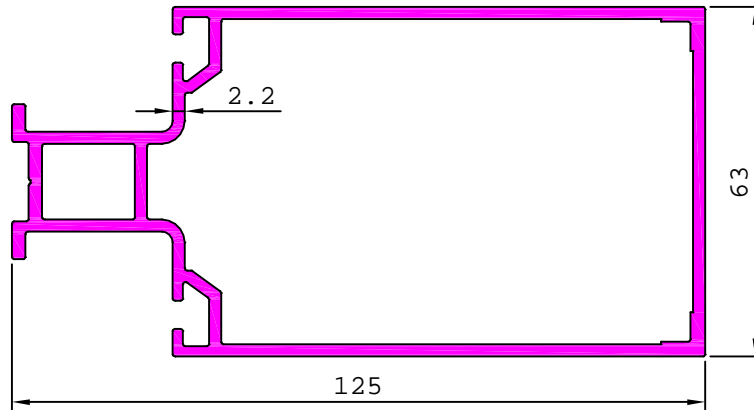

36027

1.551 kg/m

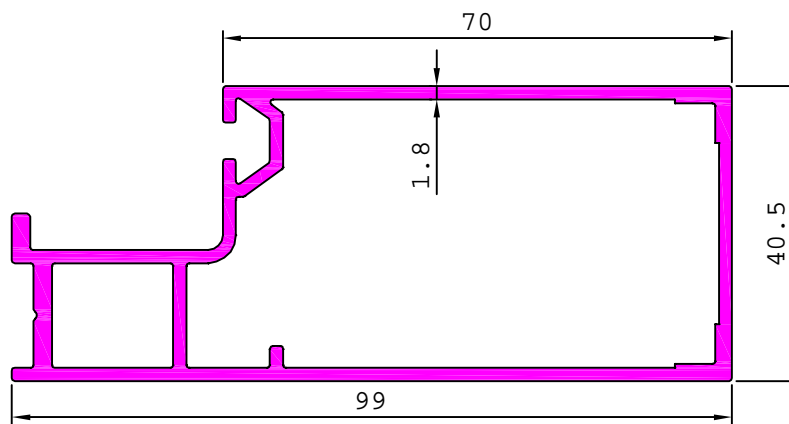

36026

1.844 kg/m

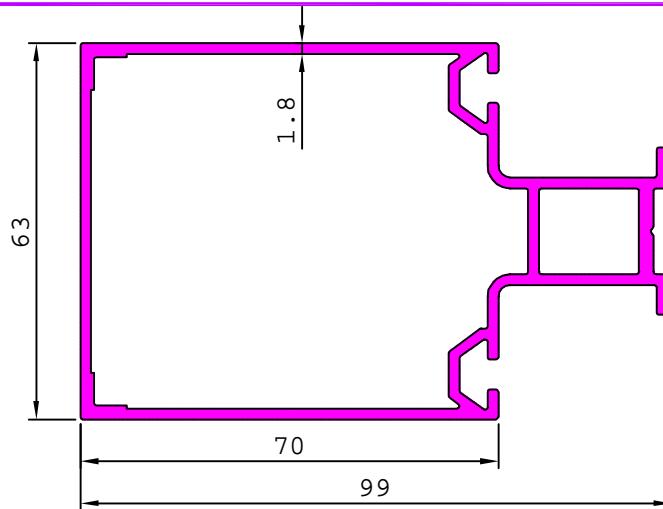

36028

0.794 kg/m

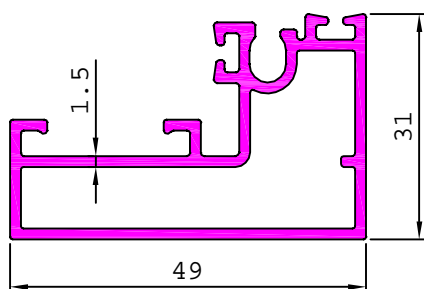

## CURTAIN WALL SECTION - 65 mm.

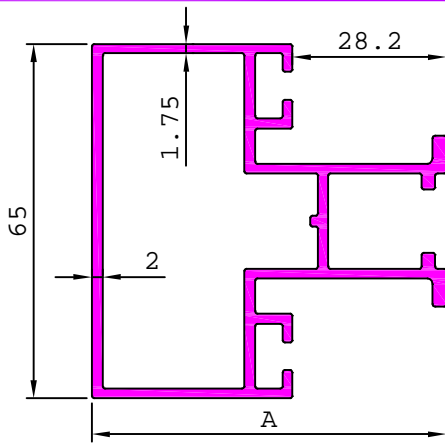

SL. No.	Section No.	A	Weight kg/m
1	<b>35778</b>	65.00	1.600
2	<b>35844</b>	120.00	2.120

35846

1.767 kg/m

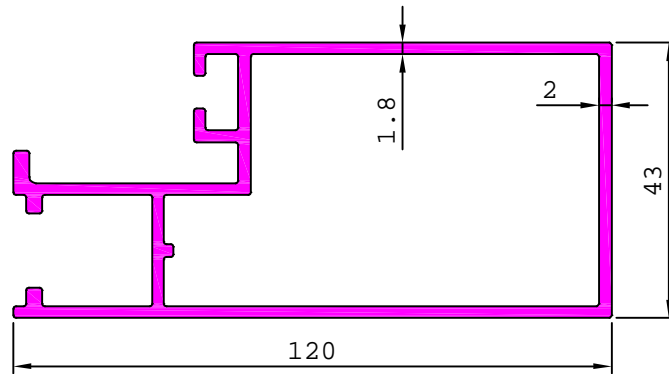

S6565

2.355 kg/m

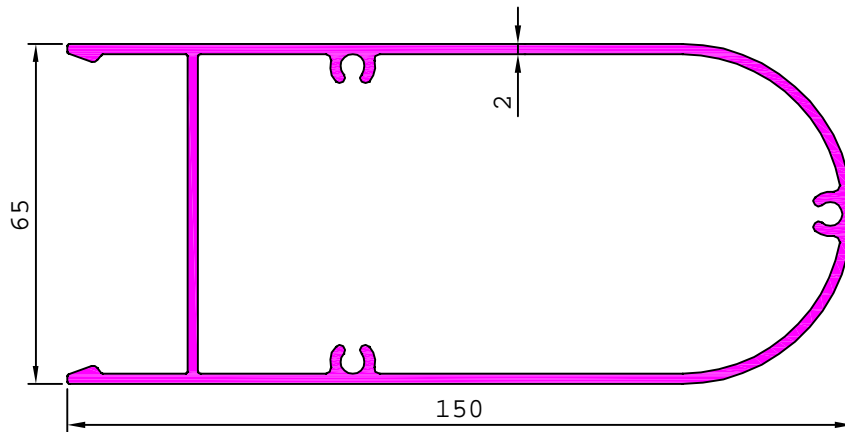

S6566

0.730 kg/m

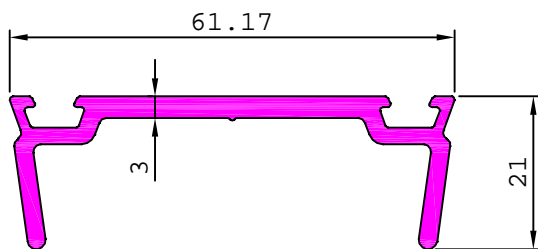

**MATCHING WITH S6565**

35931

0.755 kg/m

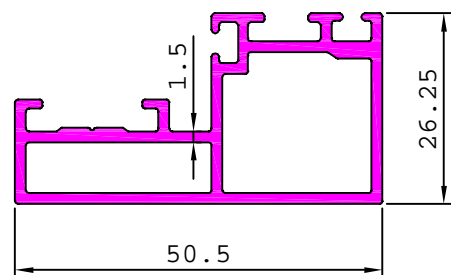

## CURTAIN WALL SECTION - 65 mm.

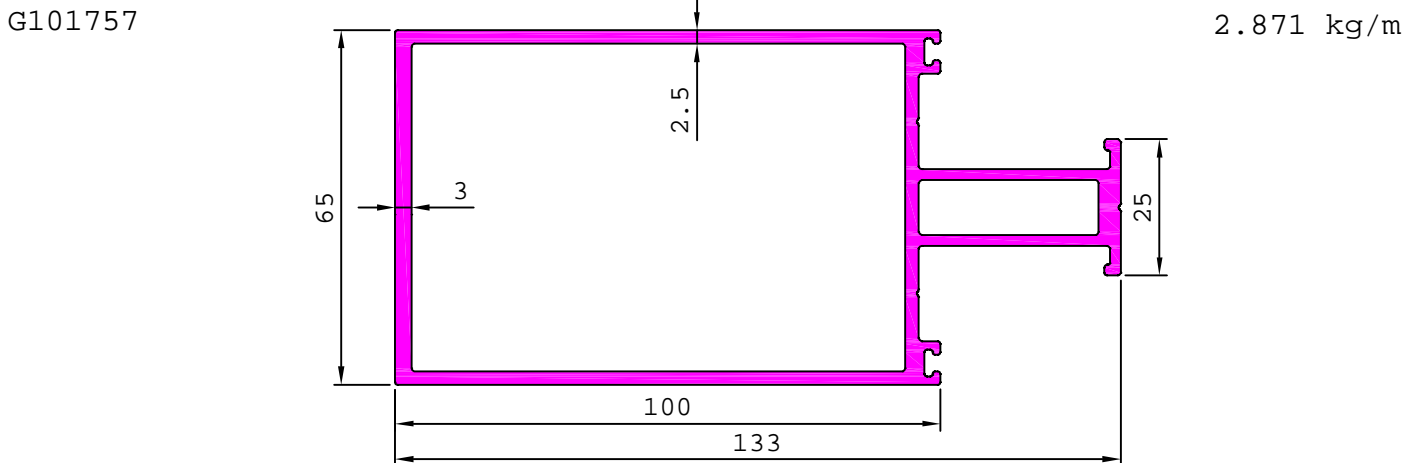
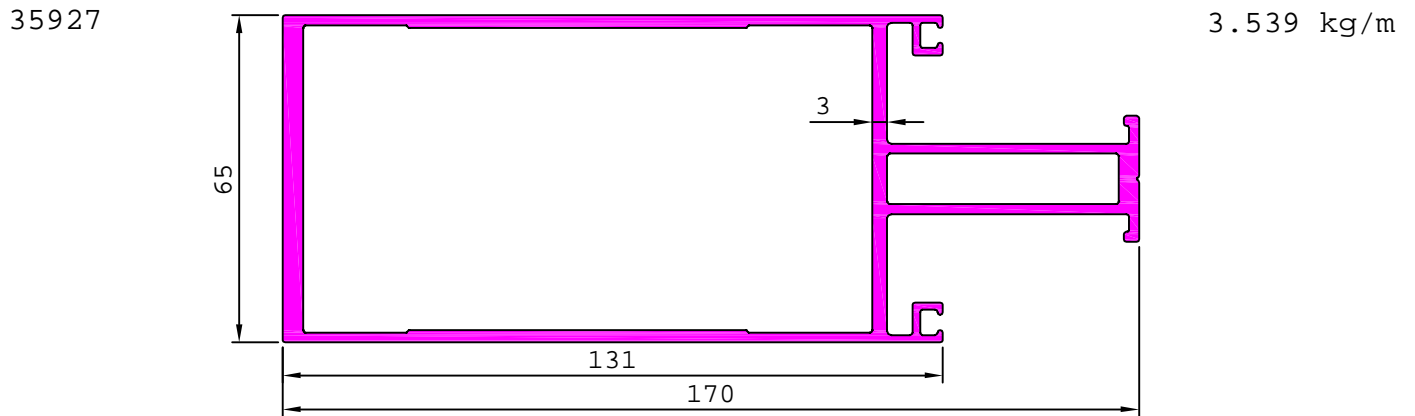
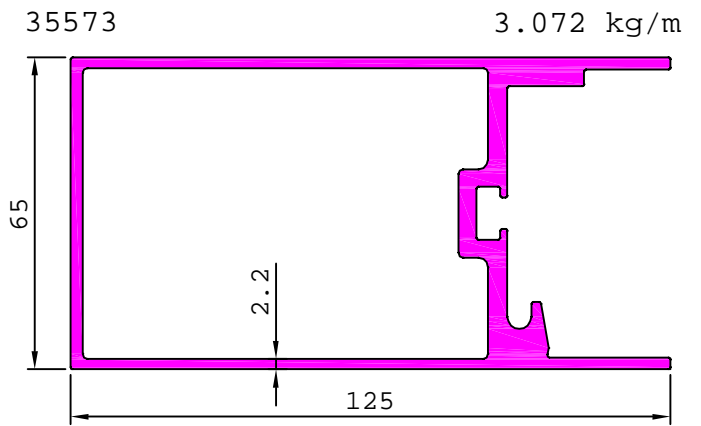
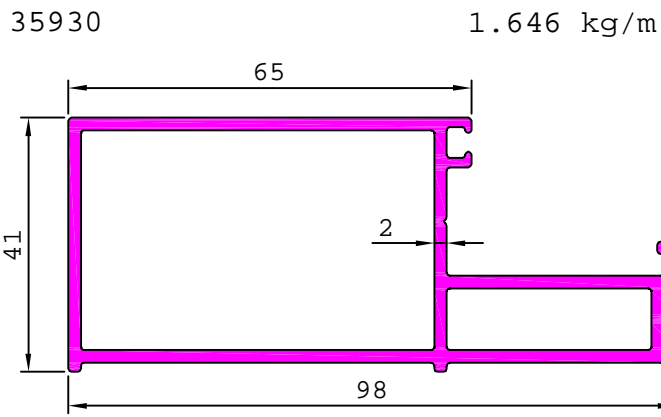
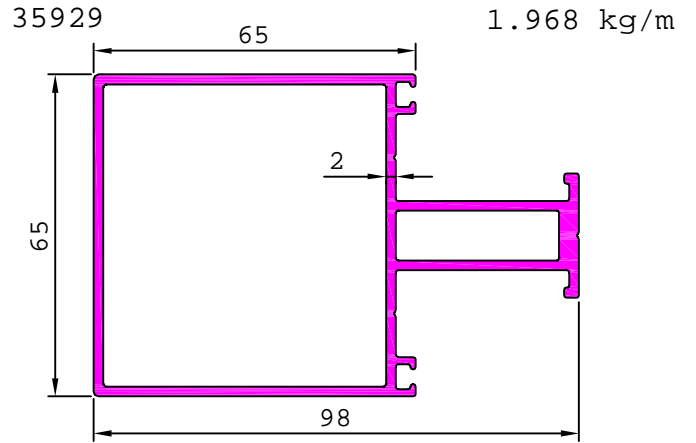
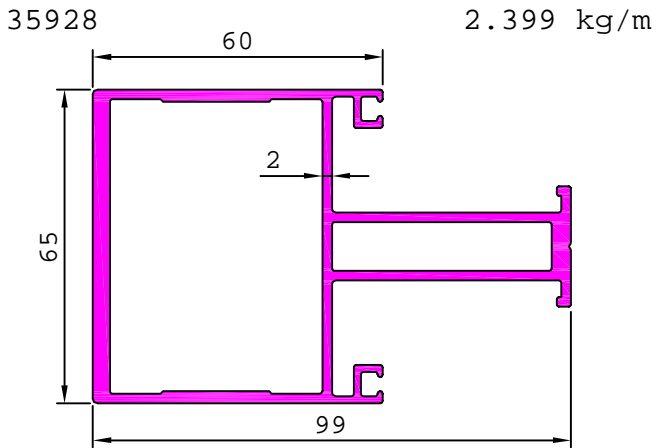

## CURTAIN WALL SECTION - 67 mm.

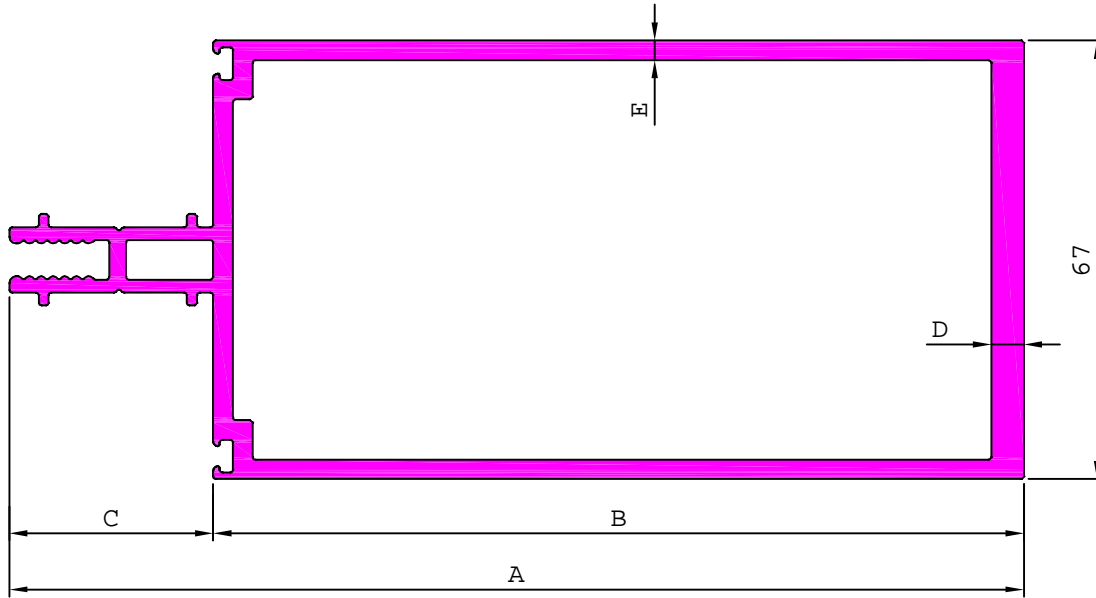

SL. No.	Section No.	A	B	C	D	E	Weight kg/m
1	<b>22842</b>	56.00	25.00	31.00	2.00	2.00	1.406
2	<b>S6641</b>	81.16	50.00	31.16	2.50	2.00	1.734
3	<b>36138</b>	96.00	65.00	31.00	2.00	2.00	1.852
4	<b>35678</b>	111.16	80.00	31.16	2.00	2.00	1.972
5	<b>35991</b>	115.00	85.00	30.00	3.00	3.00	2.895
6	<b>22843</b>	131.00	100.00	31.00	2.00	2.00	2.216
7	<b>S6594</b>	131.16	100.00	31.16	3.00	2.80	2.967
8	<b>35962</b>	140.00	109.00	31.00	4.00	3.00	3.345
9	<b>S6457</b>	155.00	123.84	31.16	1.80	1.80	2.267
10	<b>35504</b>	155.00	123.84	31.16	2.50	2.50	2.966
11	<b>35501</b>	155.00	123.84	31.16	5.00	3.00	3.781
12	<b>36192</b>	163.70	132.50	31.20	4.00	2.00	3.037
13	<b>22844</b>	166.00	135.00	31.00	5.00	3.00	3.929
14	<b>35990</b>	170.00	140.00	30.00	4.00	3.00	4.078
15	<b>35968</b>	191.00	160.00	31.00	5.00	3.00	4.365

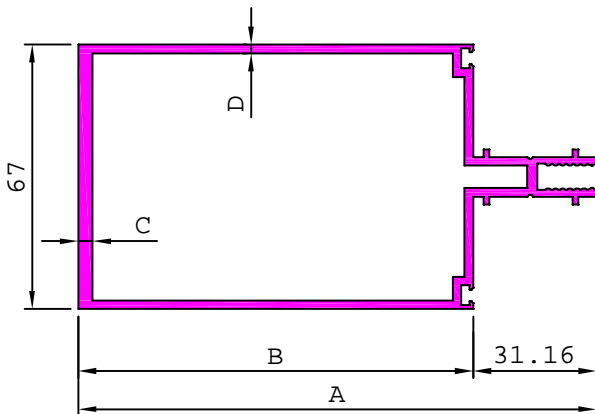

SL No	SECTION No	A	B	C	D	WEIGHT kg/m
1	<b>22736</b>	81.16	50.00	2.00	2.00	1.615
2	<b>G100339</b>	81.16	50.00	3.00	3.00	2.185
3	<b>22737</b>	131.16	100.00	3.70	2.20	2.594
4	<b>35553</b>	151.16	120.00	2.80	2.80	3.143
5	<b>35508</b>	151.16	120.00	3.70	2.35	2.947

## CURTAIN WALL SECTION - 67 mm.

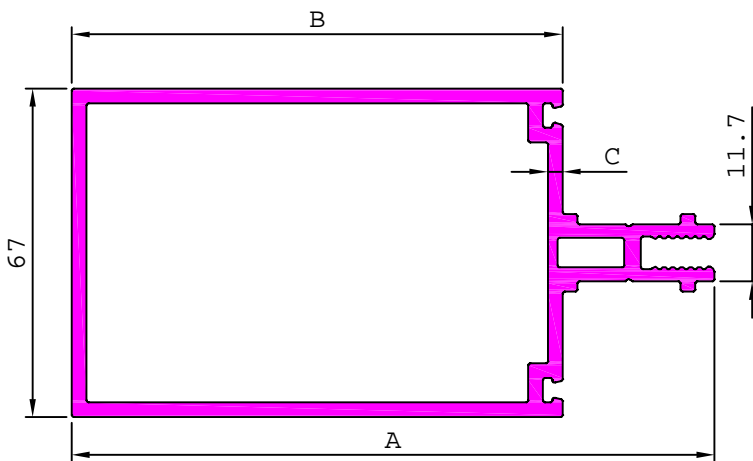
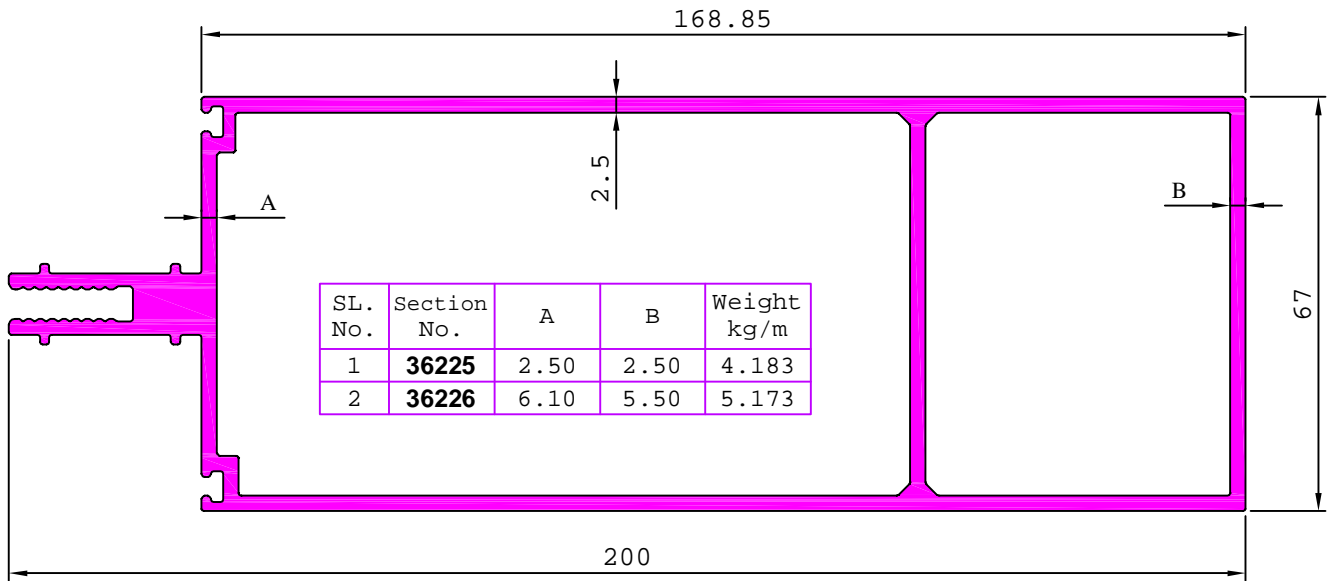

SL. No.	Section No.	A	B	C	Weight kg/m
1	<b>35855</b>	131.00	100.00	3.00	3.266
2	<b>35854</b>	166.00	135.00	5.00	5.863
3	<b>35924</b>	166.00	135.00	3.00	3.854

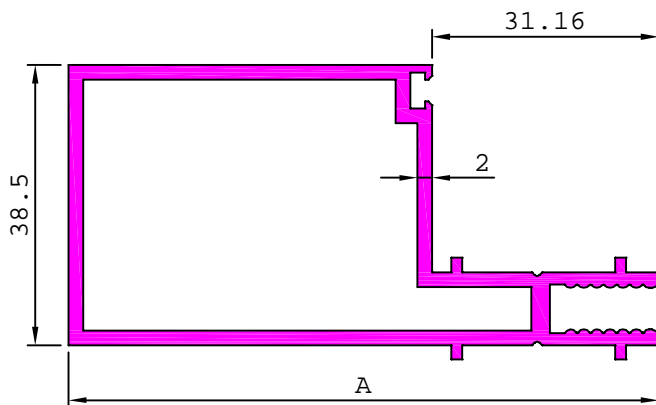

SL No	SECTION No	A	WEIGHT kg/m
1	<b>22738</b>	81.16	1.294
2	<b>22739</b>	131.16	1.881

## CURTAIN WALL SECTION - 67 mm.

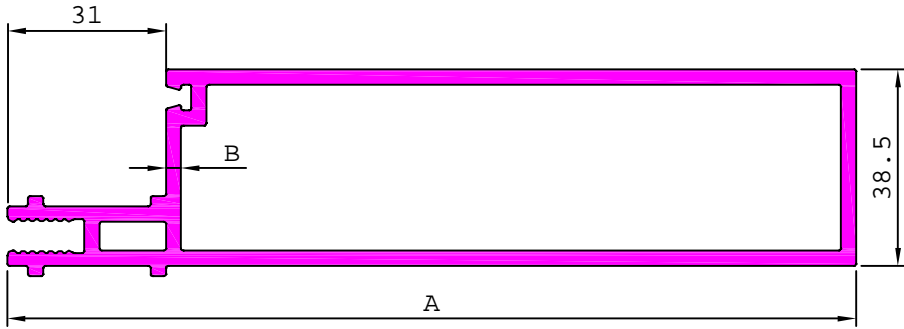

SL. No.	Section No.	A	B	Weight kg/m
1	<b>35901</b>	166.00	3.00	3.361
2	<b>35857</b>	166.00	5.00	5.062
2	<b>36139</b>	96.00	2.00	1.508

36240

0.623 kg/m

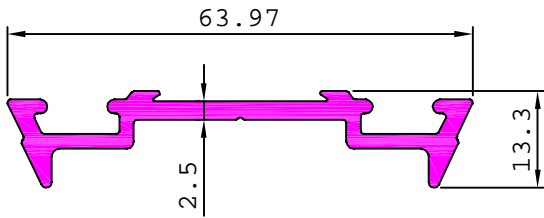

MATCHING WITH G104232

36241

0.594 kg/m

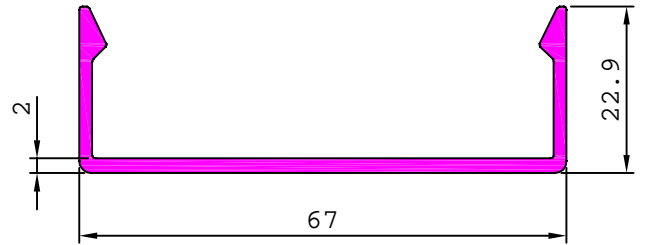

35951

200

5.500 kg/m

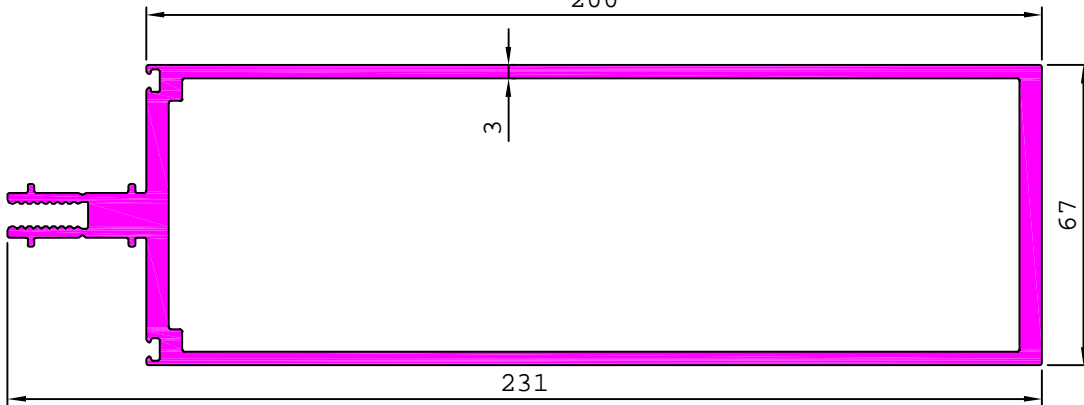

35975

160

3.560 kg/m

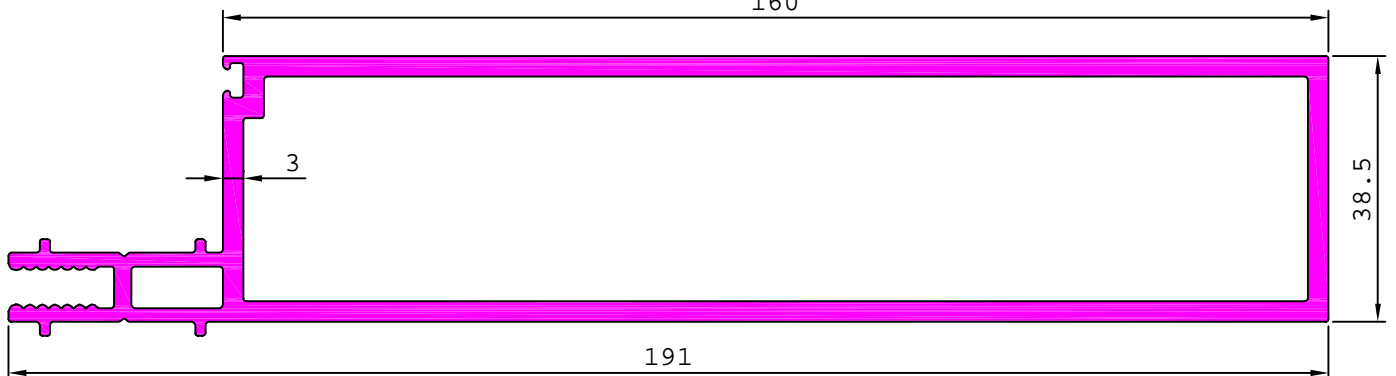

**CURTAIN WALL SECTION - 67 mm.**

35824

2.244 kg/m

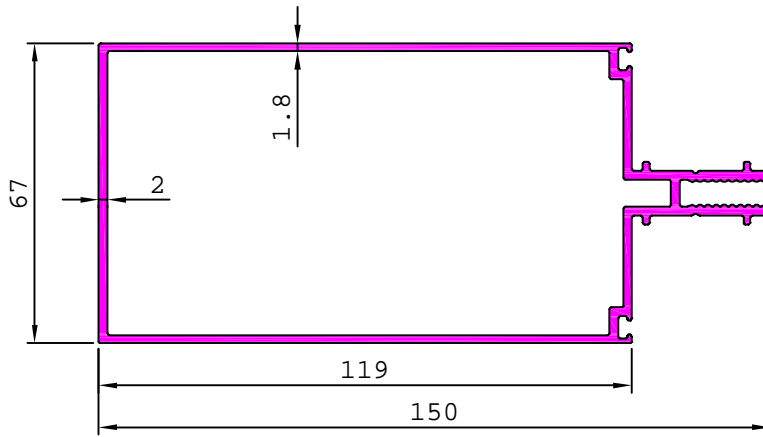

36280

9.453 kg/m

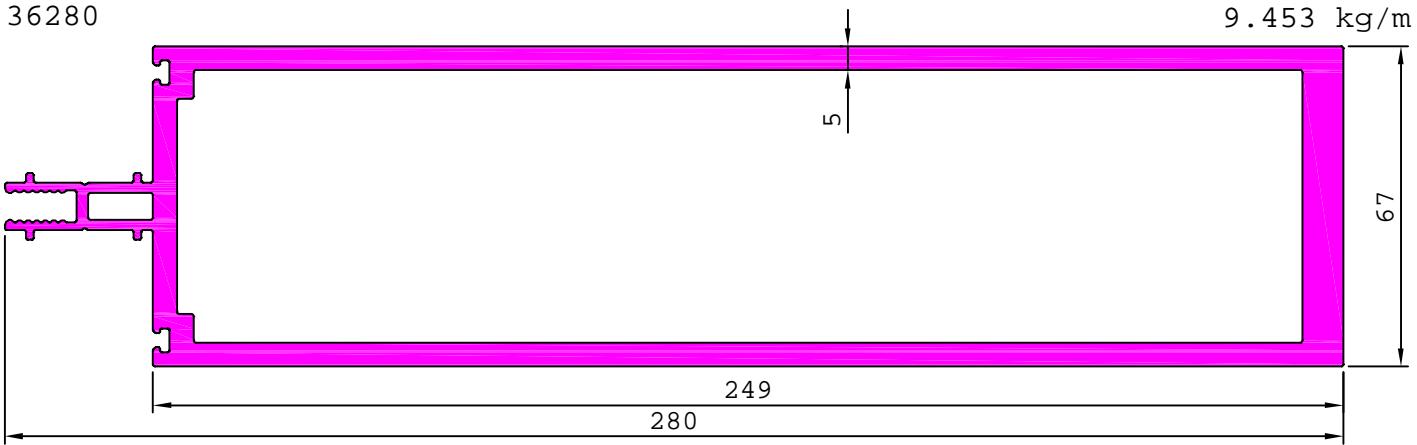

36133

3.665 kg/m

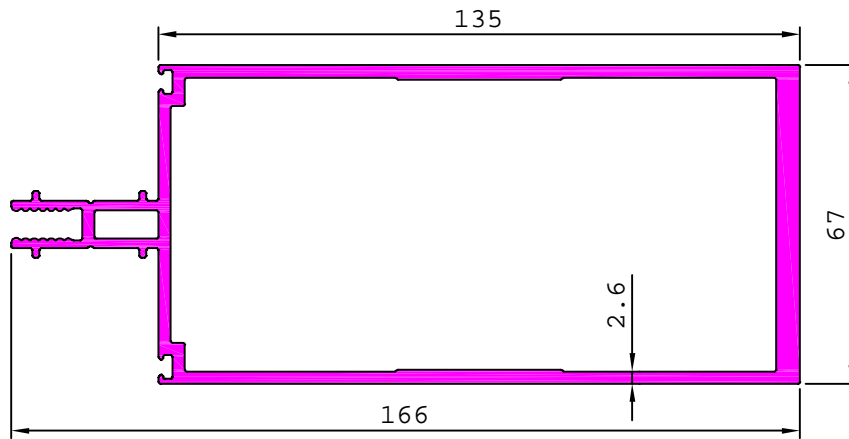

36076

1.925 kg/m

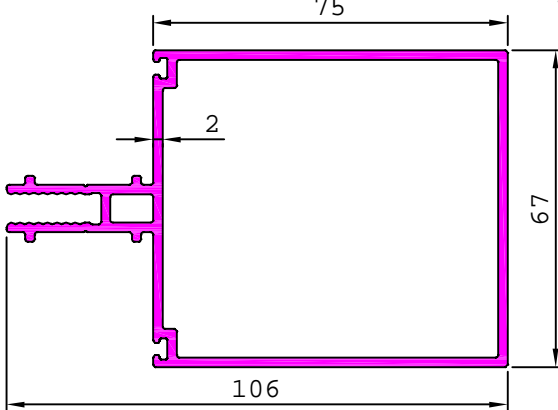

36077

0.718 kg/m

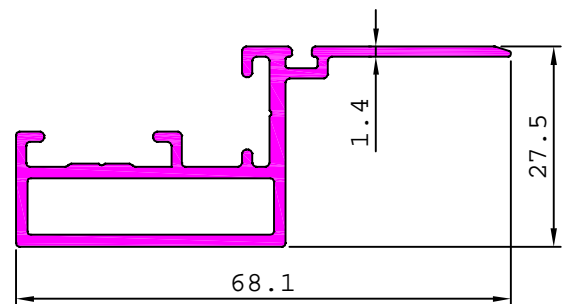

## CURTAIN WALL SECTION - 67 mm.

22840

0.693 kg/m

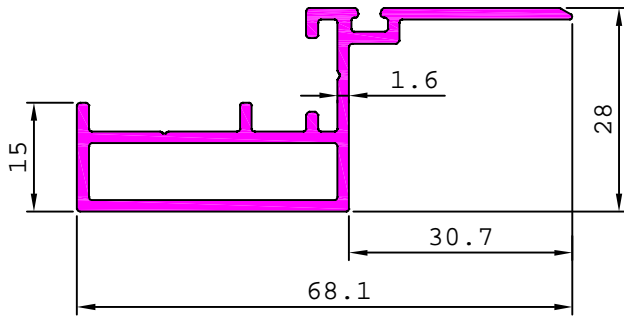

22841

0.849 kg/m

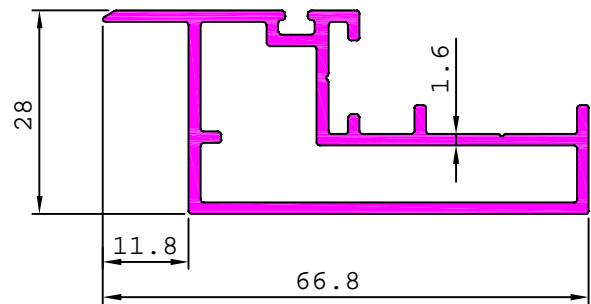

22740

0.586 kg/m

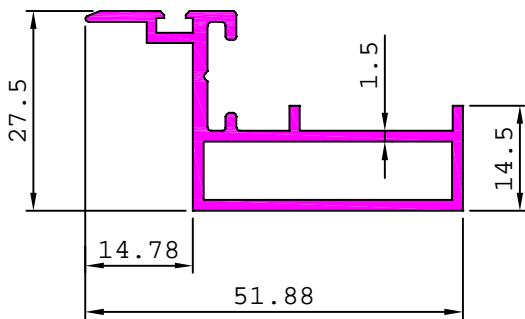

35856

1.506 kg/m

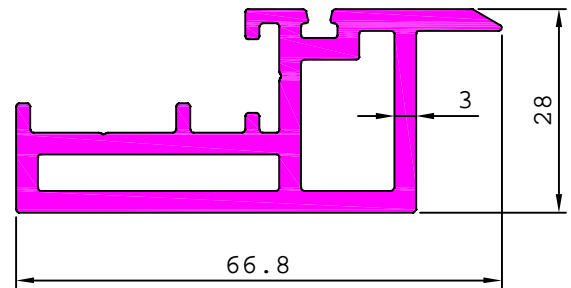

S6586

8.334 kg/m

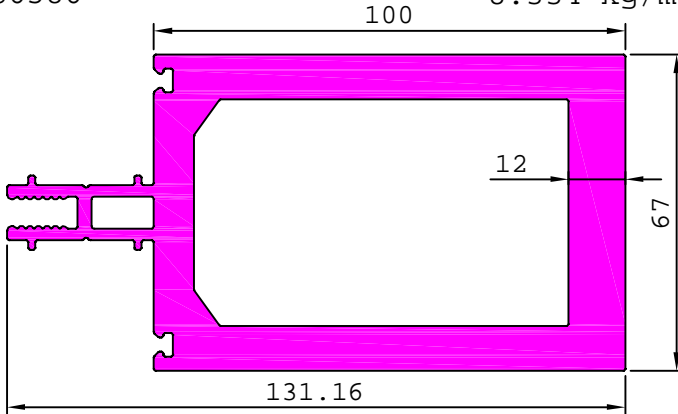

36158

1.693 kg/m

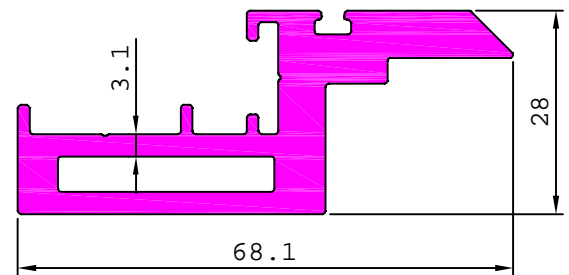

35782

4.320 kg/m

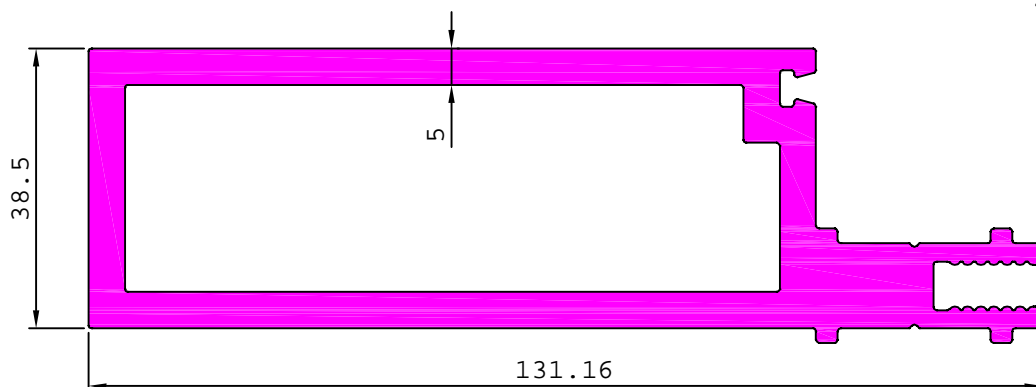

## CURTAIN WALL SECTION - 67 mm.

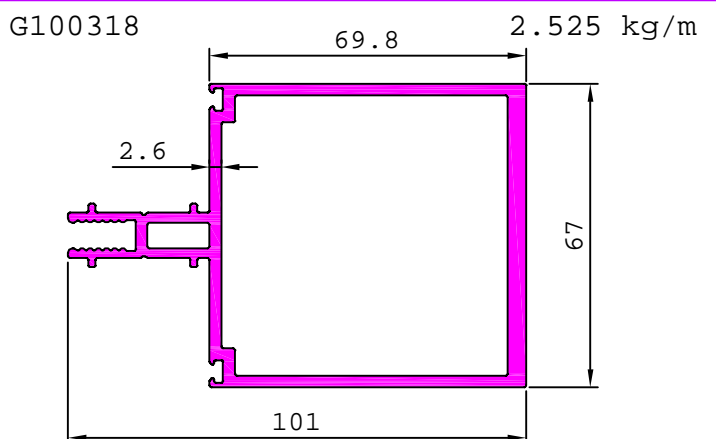
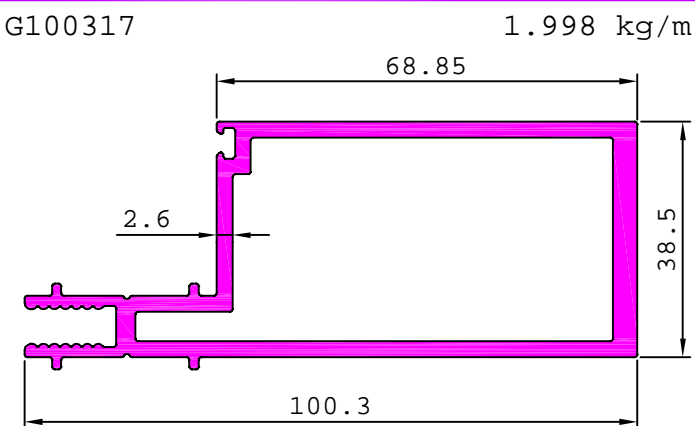
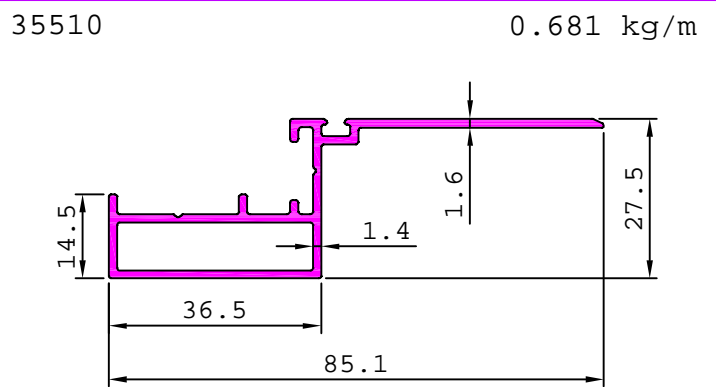
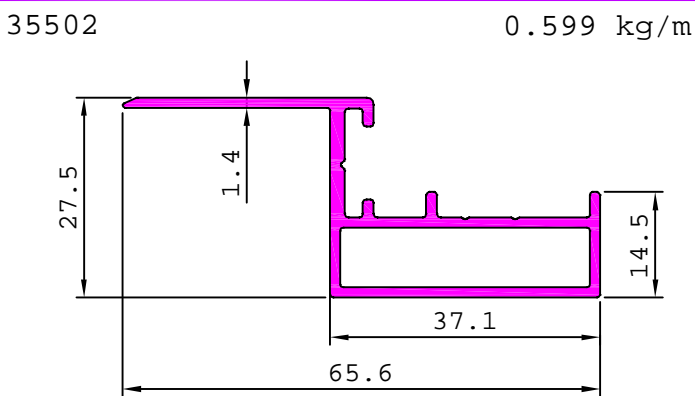
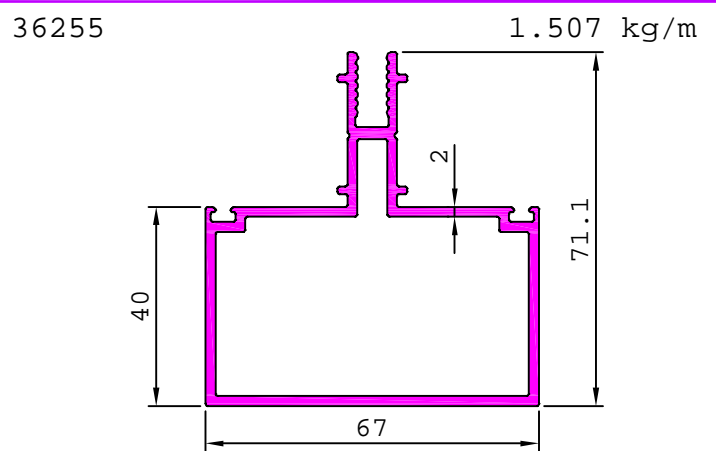
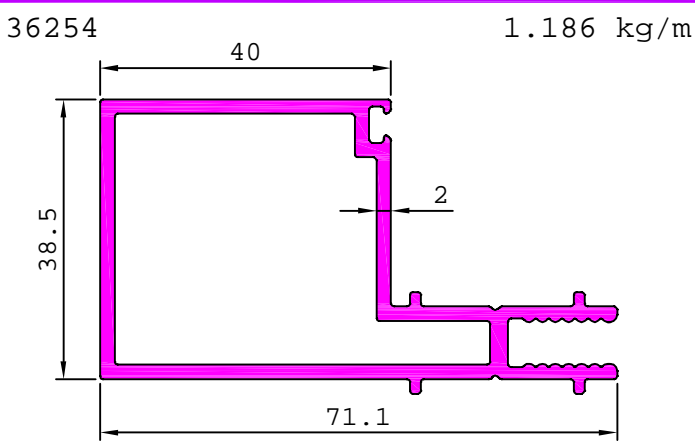
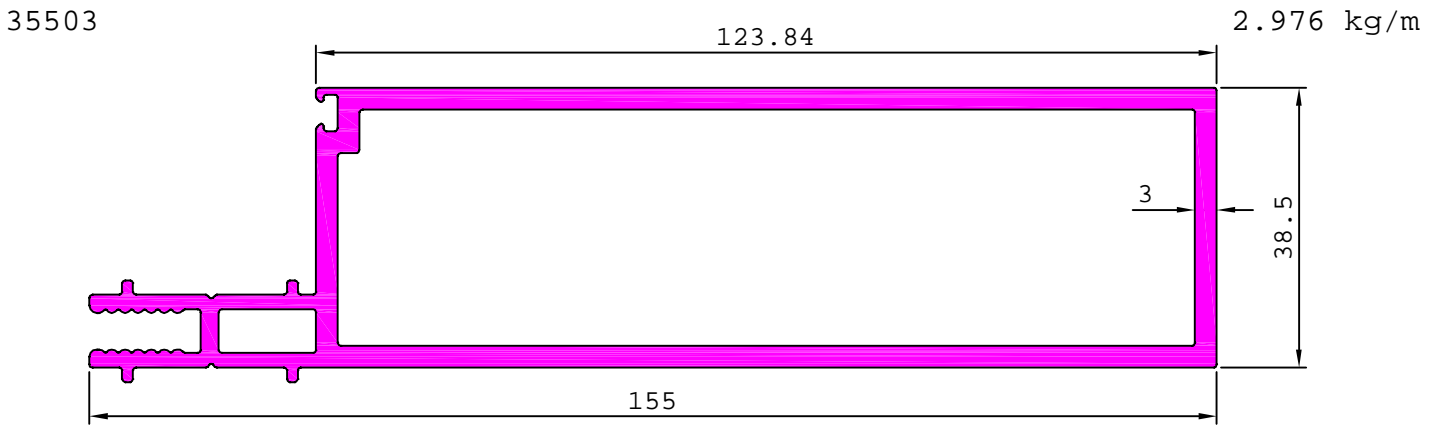

### CURTAIN WALL SECTION - 67 mm.

G100735

2.373 kg/m

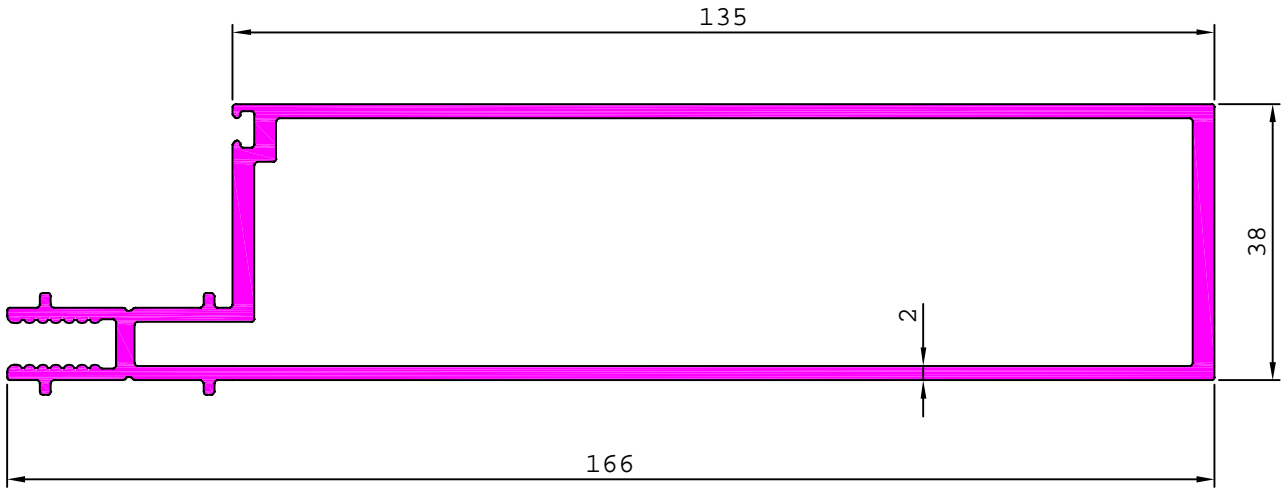

G100963

4.227 kg/m

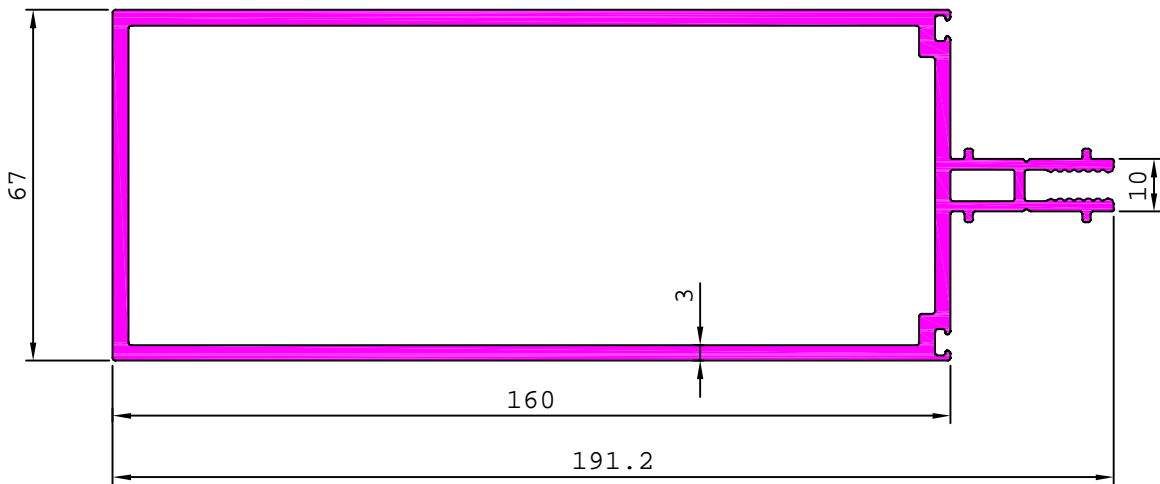

G100736

2.935 kg/m

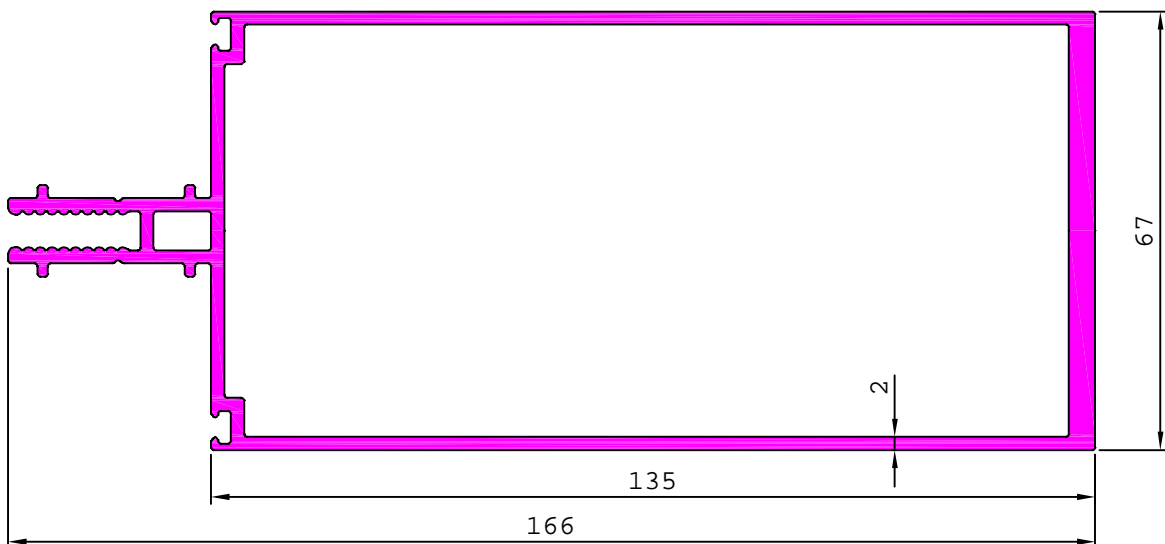

## CURTAIN WALL SECTION - 67 mm.

G100319

1.002 kg/m



G100320

0.912 kg/m

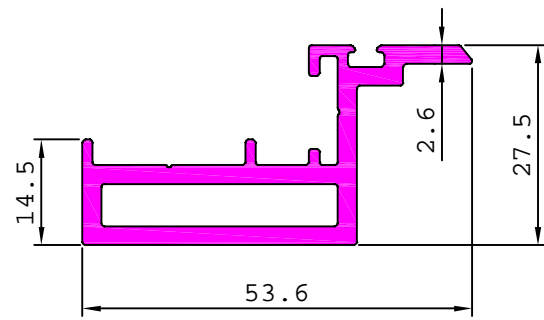

## CURTAIN WALL SECTION - 70 mm.

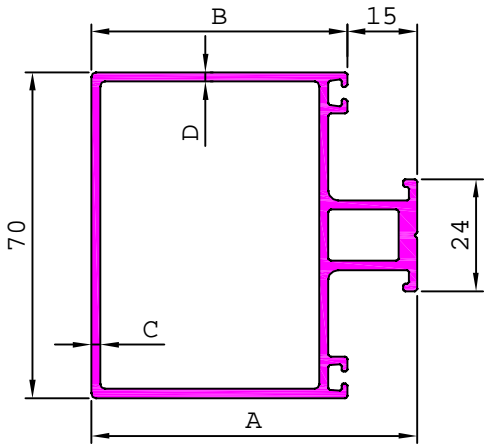

SL No	SECTION No	A	B	C	D	WEIGHT kg/m
1	<b>29248</b>	70.00	55.00	2.00	2.00	1.738
2	<b>29221</b>	70.00	55.00	2.50	2.50	2.040
3	<b>29223</b>	130.00	115.00	2.50	2.25	2.663

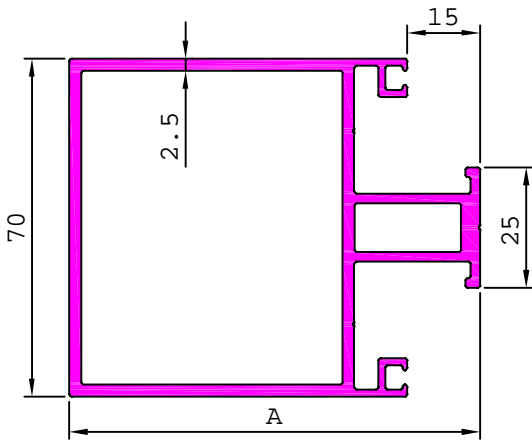

SL No	SECTION No	A	WEIGHT kg/m
1	<b>29156</b>	85.00	2.321
2	<b>22837</b>	157.00	3.293

S6225

0.263 kg/m

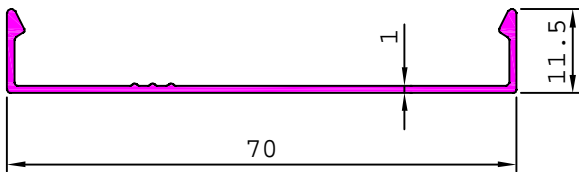

S6226

0.434 kg/m

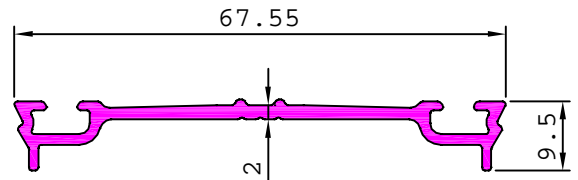

S6364

0.767 kg/m

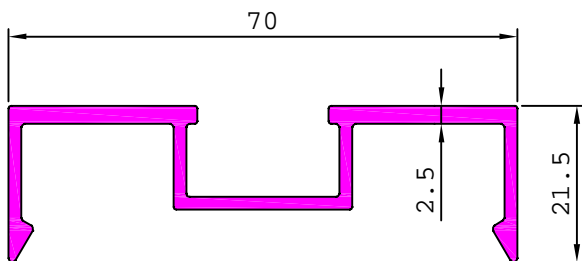

S6365

0.724 kg/m

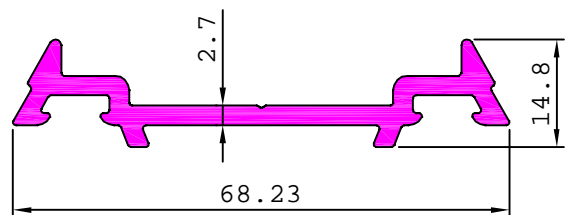

## CURTAIN WALL SECTION - 70 mm.

29222

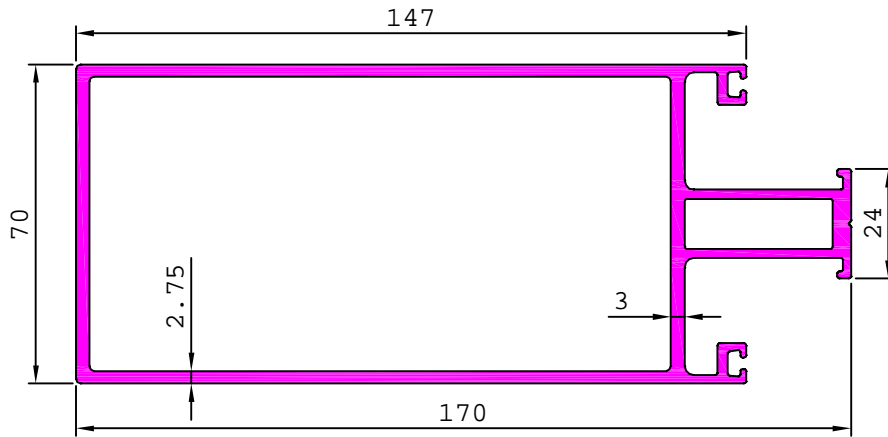

3.875 kg/m

29224

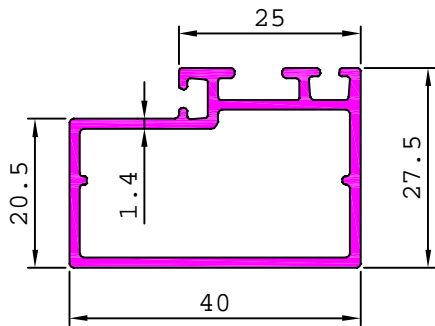

0.572 kg/m

29225

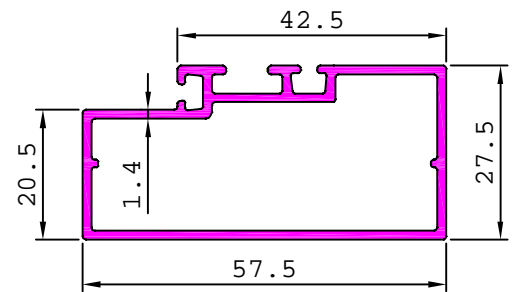

0.722 kg/m

35963

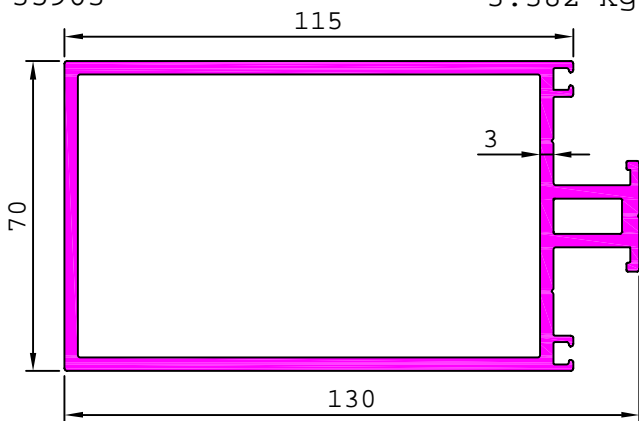

3.382 kg/m

S6204

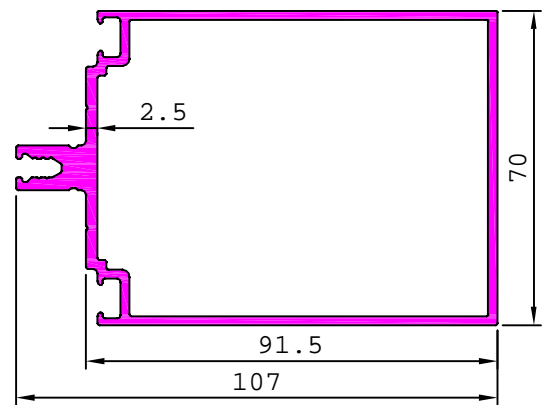

2.112 kg/m

35964

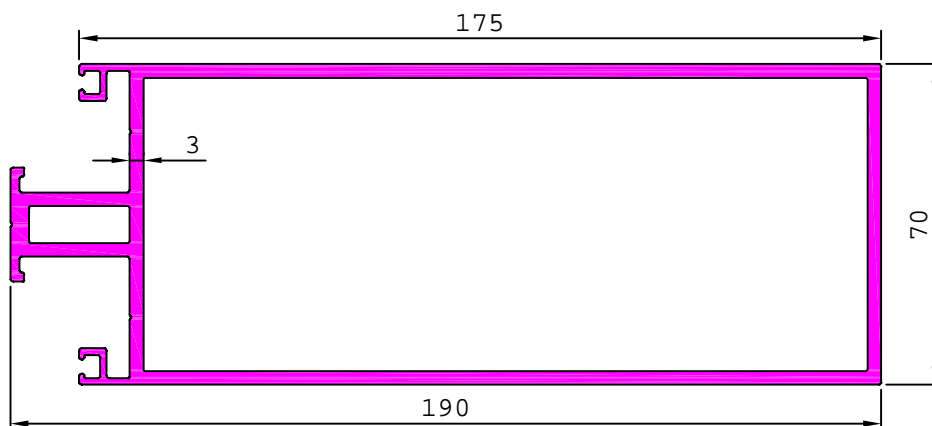

4.459 kg/m

**CURTAIN WALL SECTION - 70 mm.**

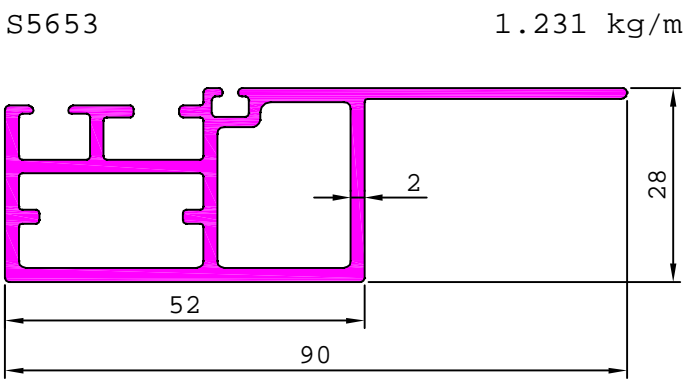
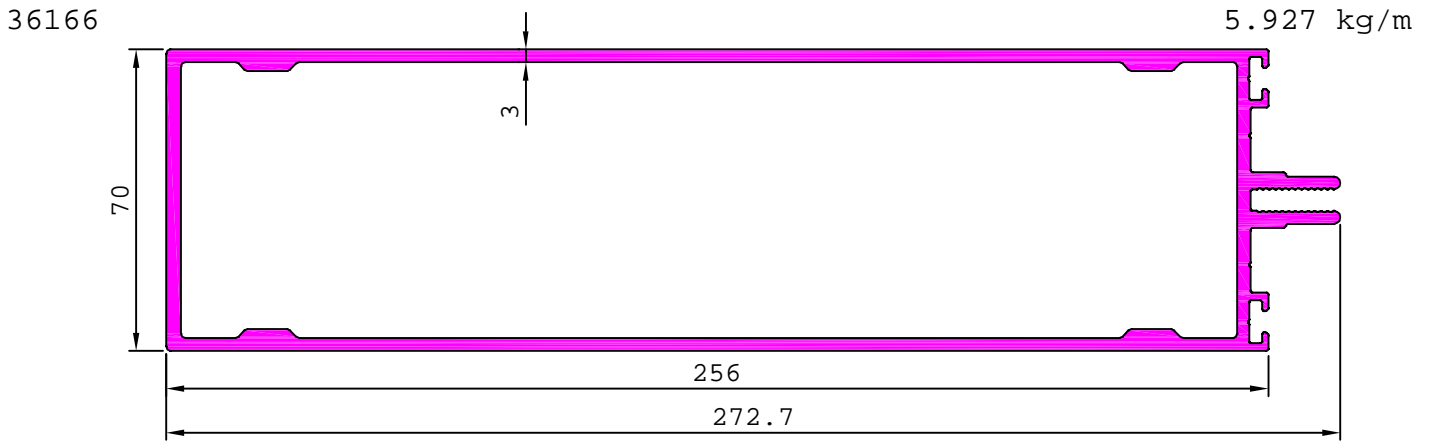

MATCHING WITH S5655

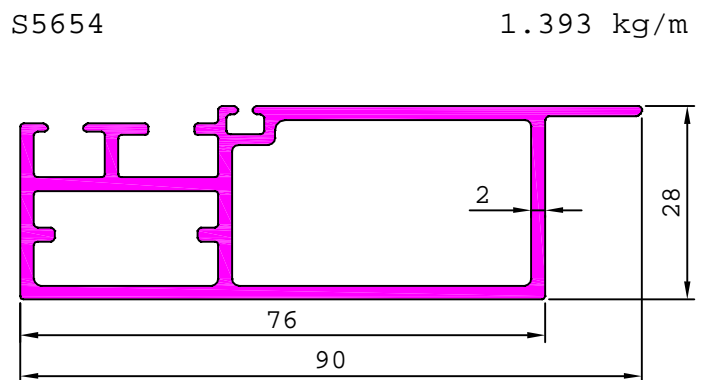

MATCHING WITH S5655

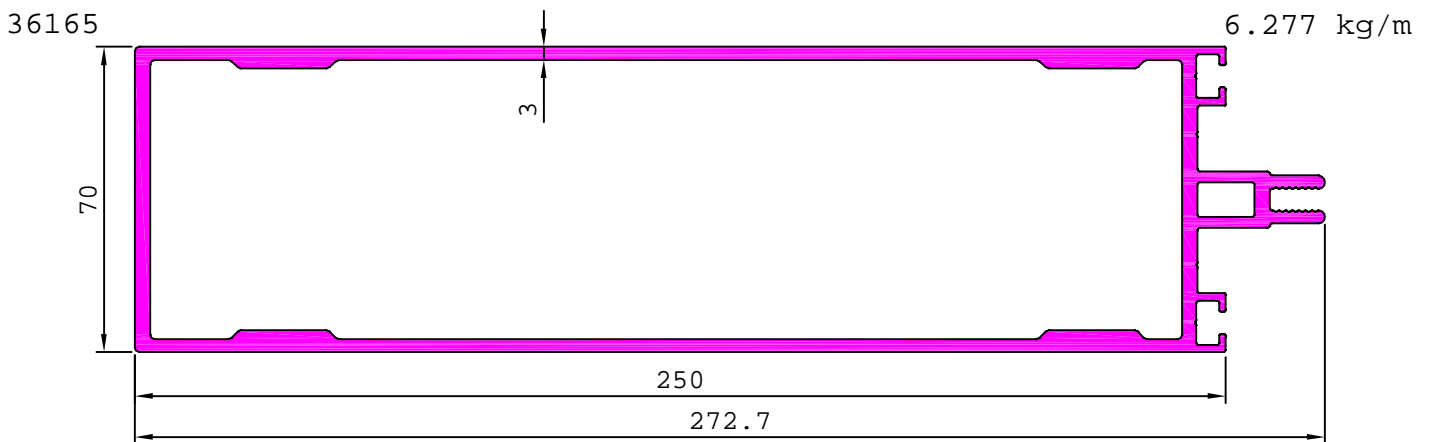
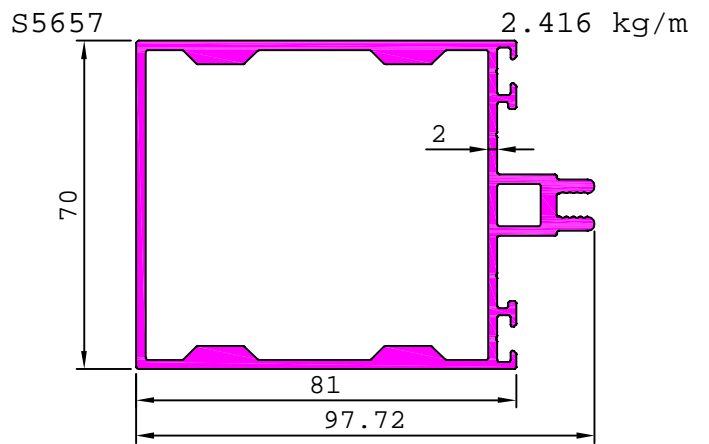
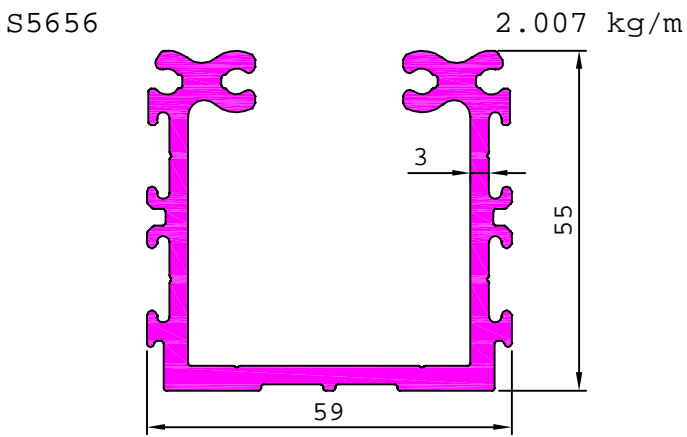

**CURTAIN WALL SECTION - 70 mm.**

36023

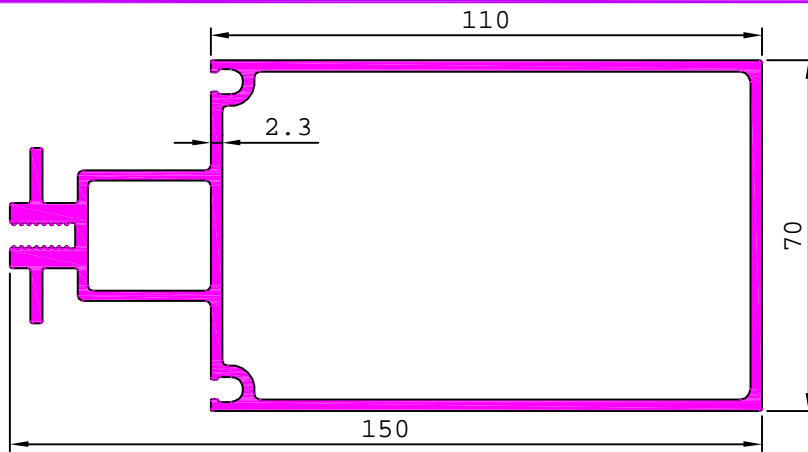

3.108 kg/m

35805

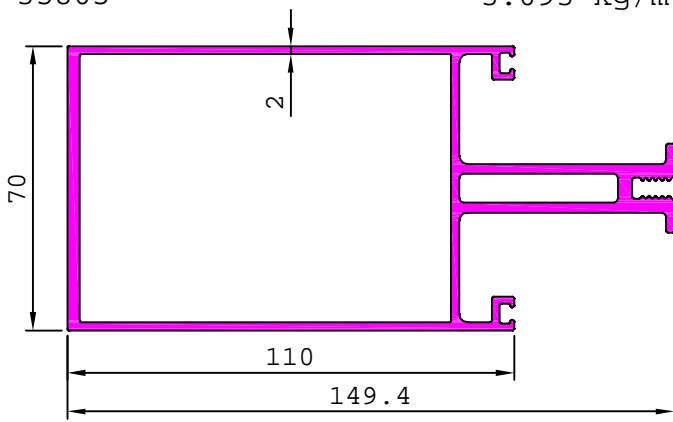

3.093 kg/m

35808

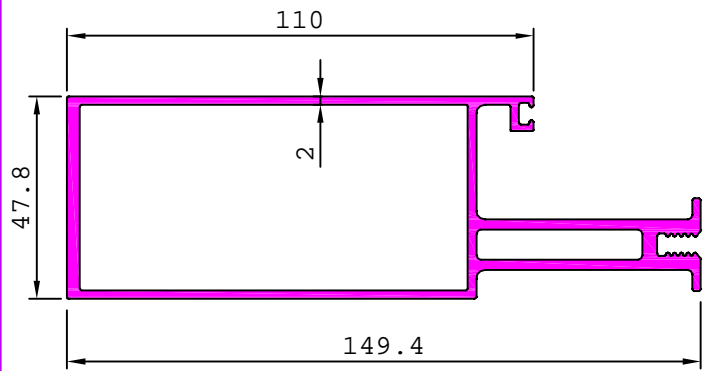

2.667 kg/m

35806

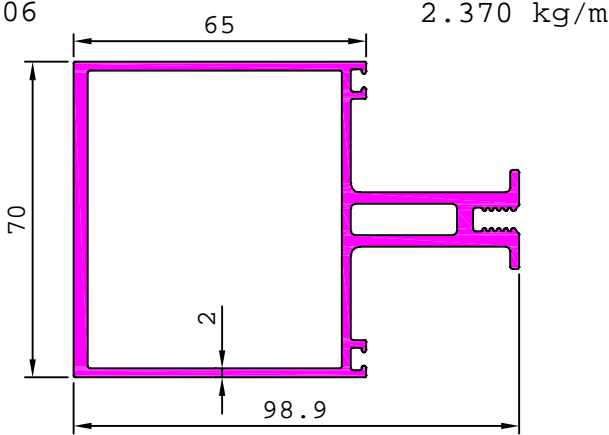

2.370 kg/m

35807

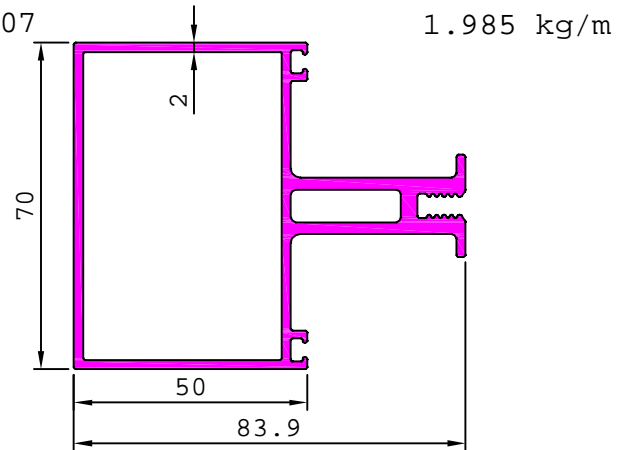

1.985 kg/m

35813

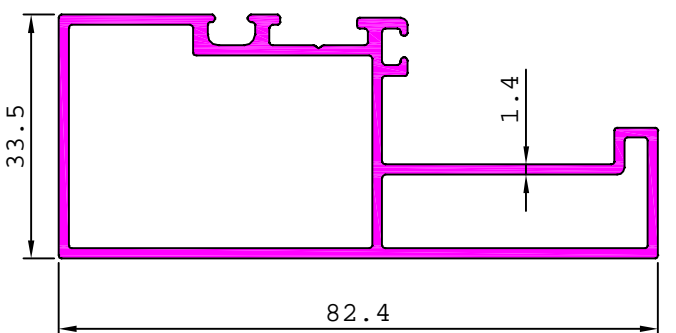

1.034 kg/m

35671

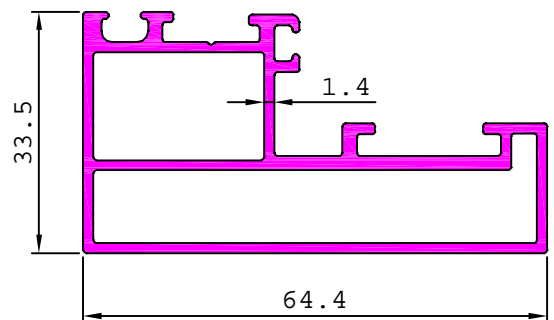

1.035 kg/m

**CURTAIN WALL SECTION - 70 mm.**

S6203

3.759 kg/m

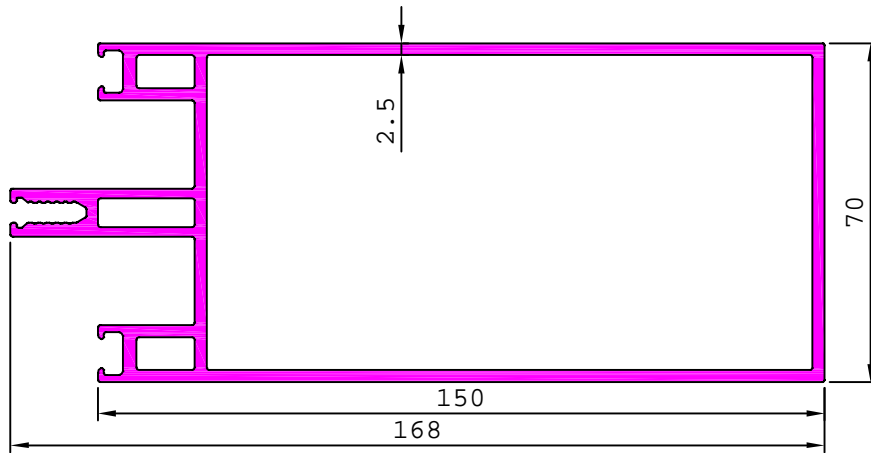

35849

2.386 kg/m

35809

0.358 kg/m

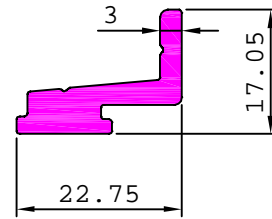
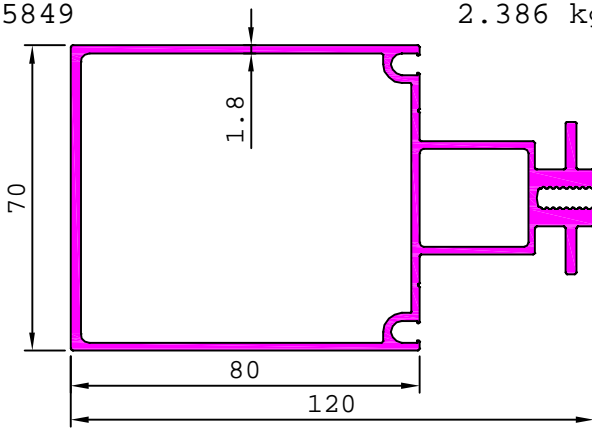

MATCHING WITH 35671,35813

35850

1.883 kg/m

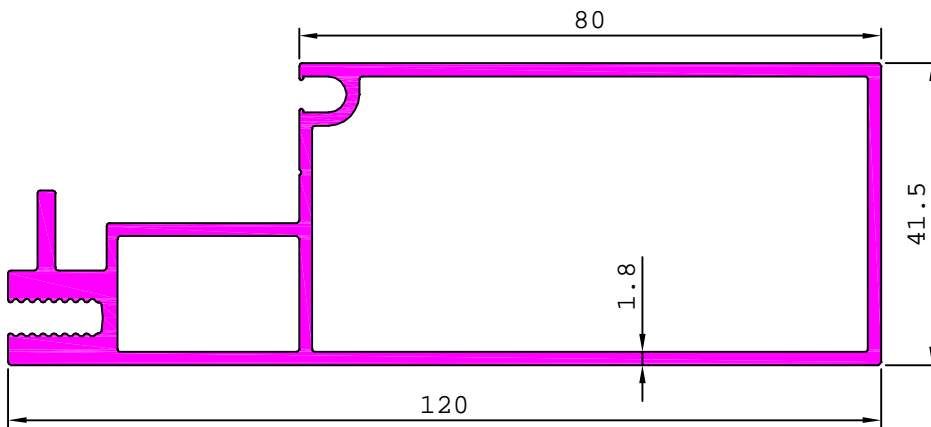

35895

6.651 kg/m

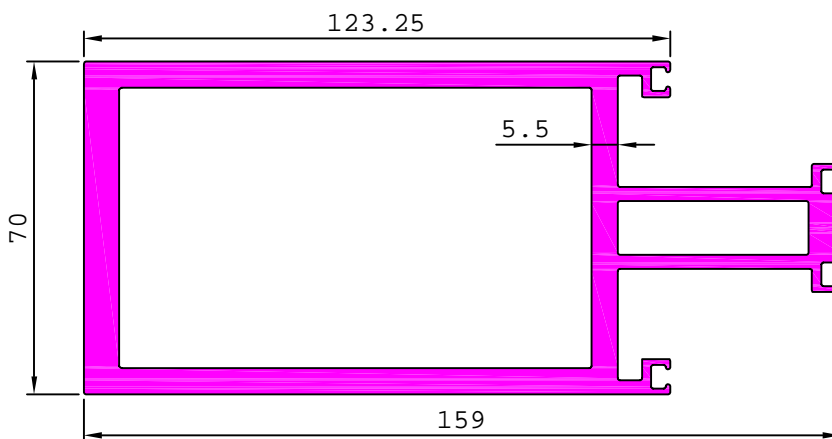

## CURTAIN WALL SECTION - 70 mm.

35896

1.080 kg/m

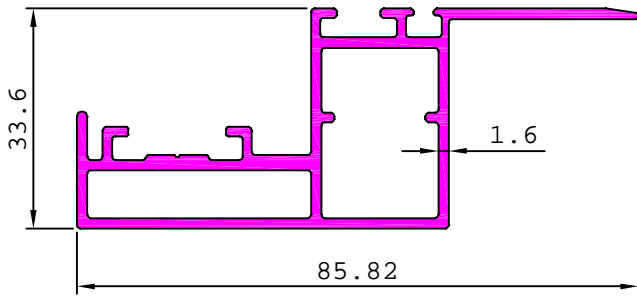

22806

1.069 kg/m

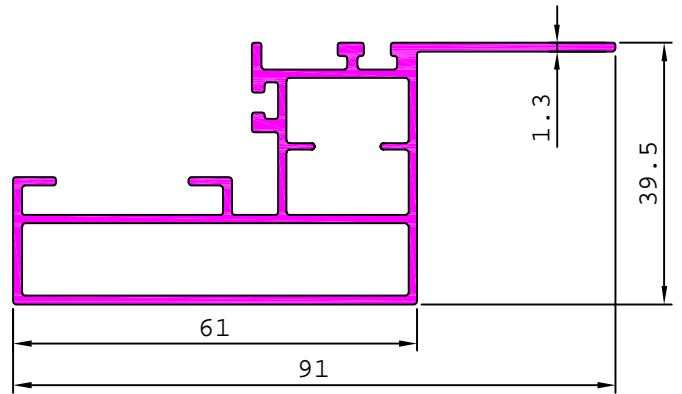

22799

1.006 kg/m

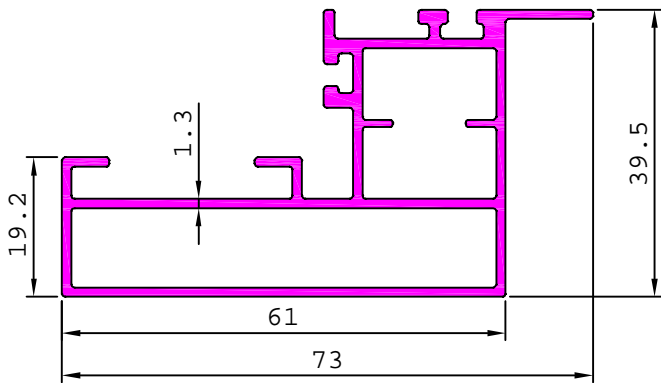

22801

2.005 kg/m

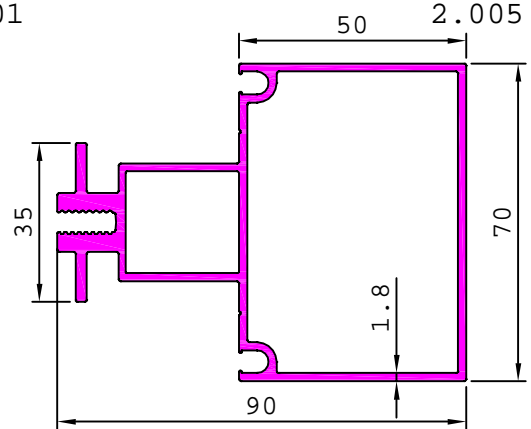

22800

1.592 kg/m

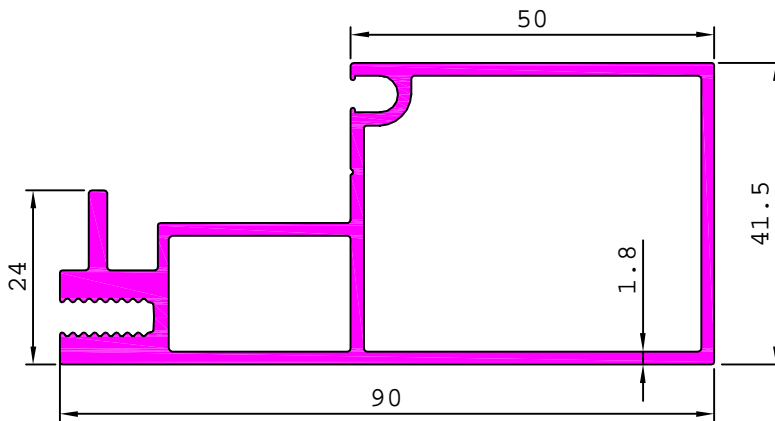

## CURTAIN WALL SECTION - 70 mm.

S6516

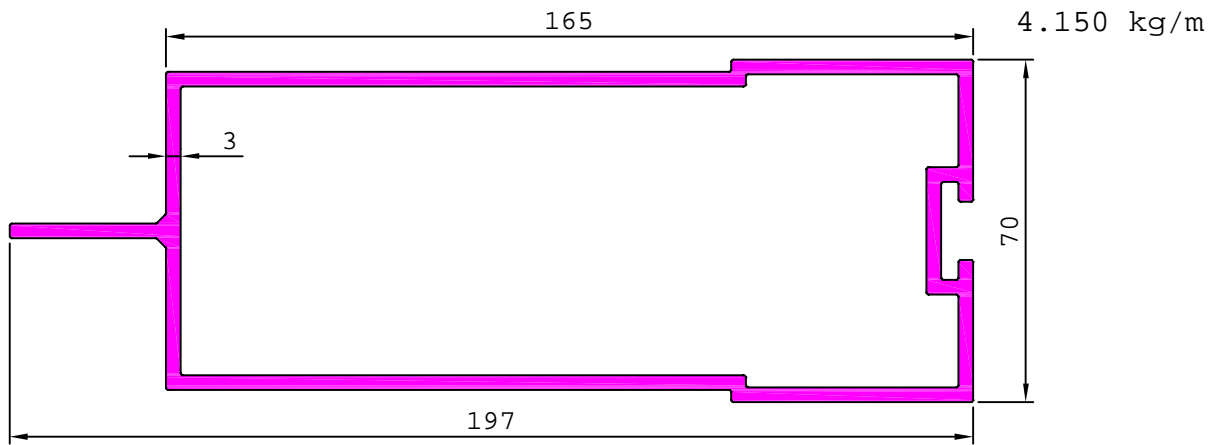

S6517

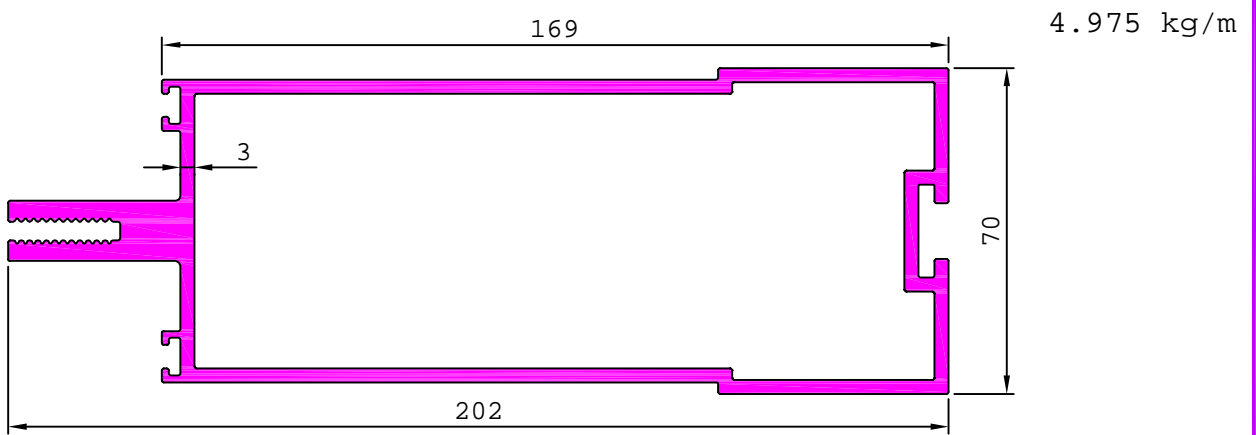

S6518

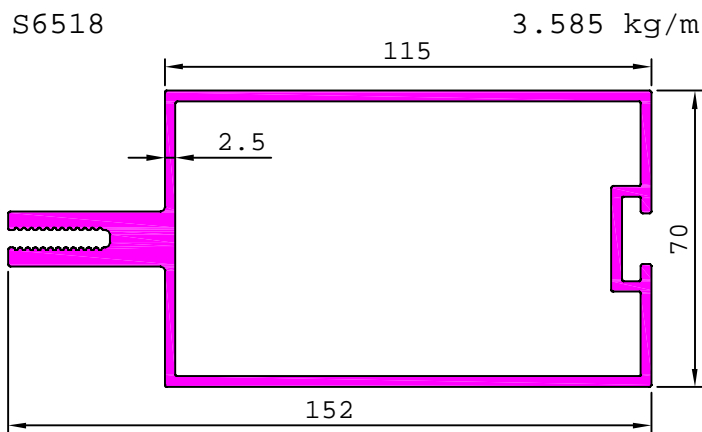

S6519

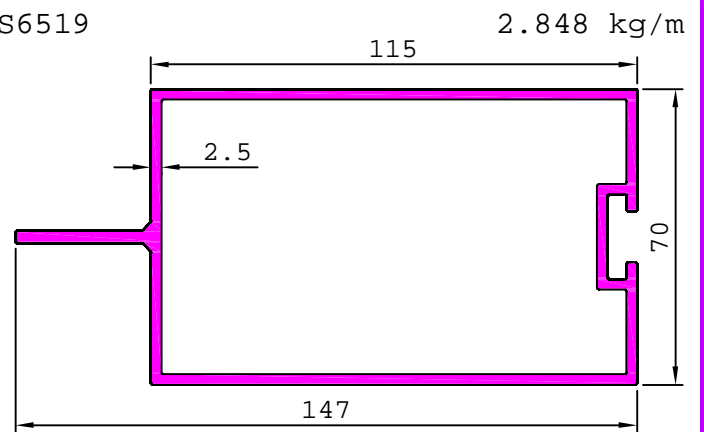

36189

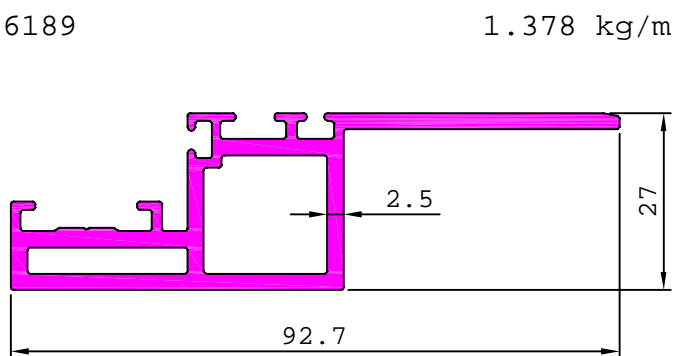

36191

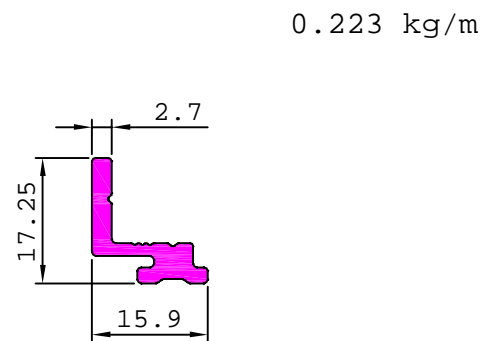

MATCHING WITH 36191,36188,36187

MATCHING WITH 36189

**CURTAIN WALL SECTION - 70 mm.**

36188

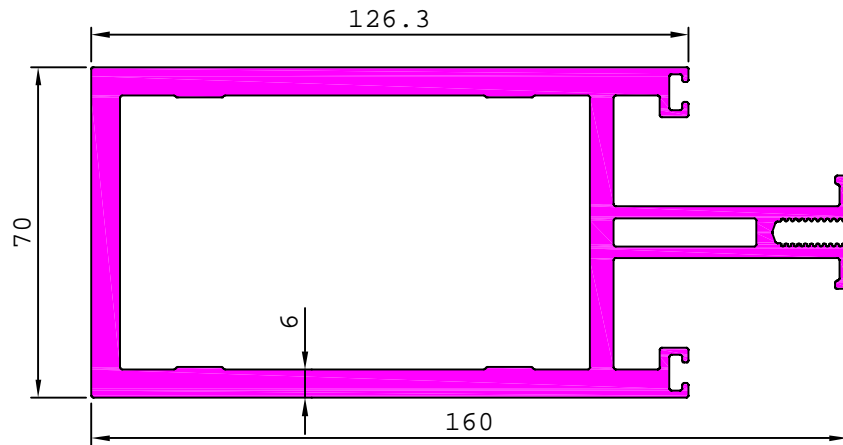

6.712 kg/m

36187

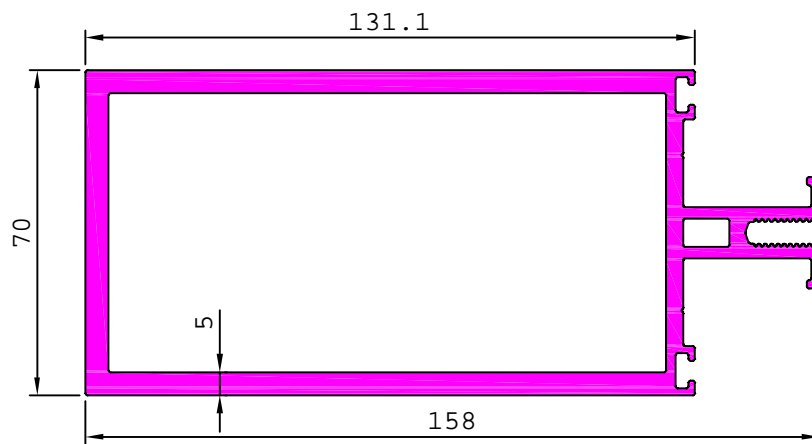

5.444 kg/m

36190

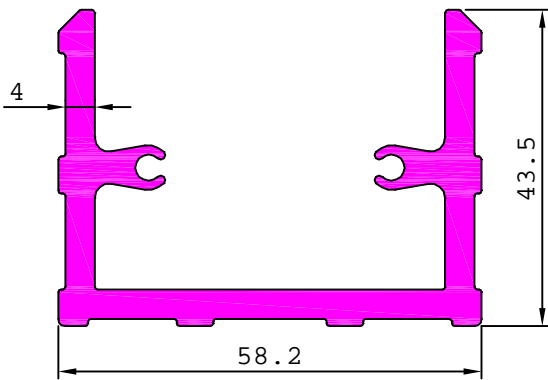

1.758 kg/m

36297

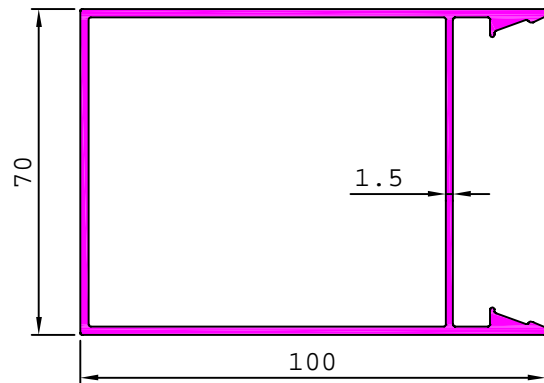

1.662 kg/m

MATCHING WITH 36298 ,G102873,G102874

36298

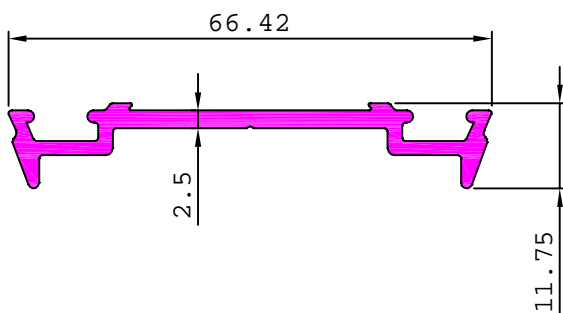

0.583 kg/m

MATCHING WITH 36297

### CURTAIN WALL SECTION - 70 mm.

G101108

2.614 kg/m

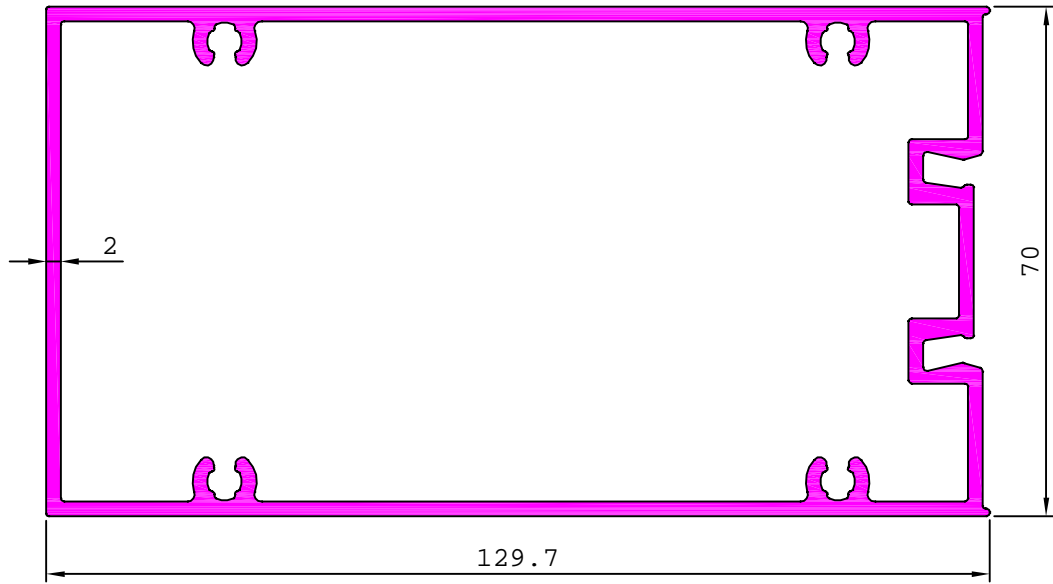

G101217

3.241 kg/m

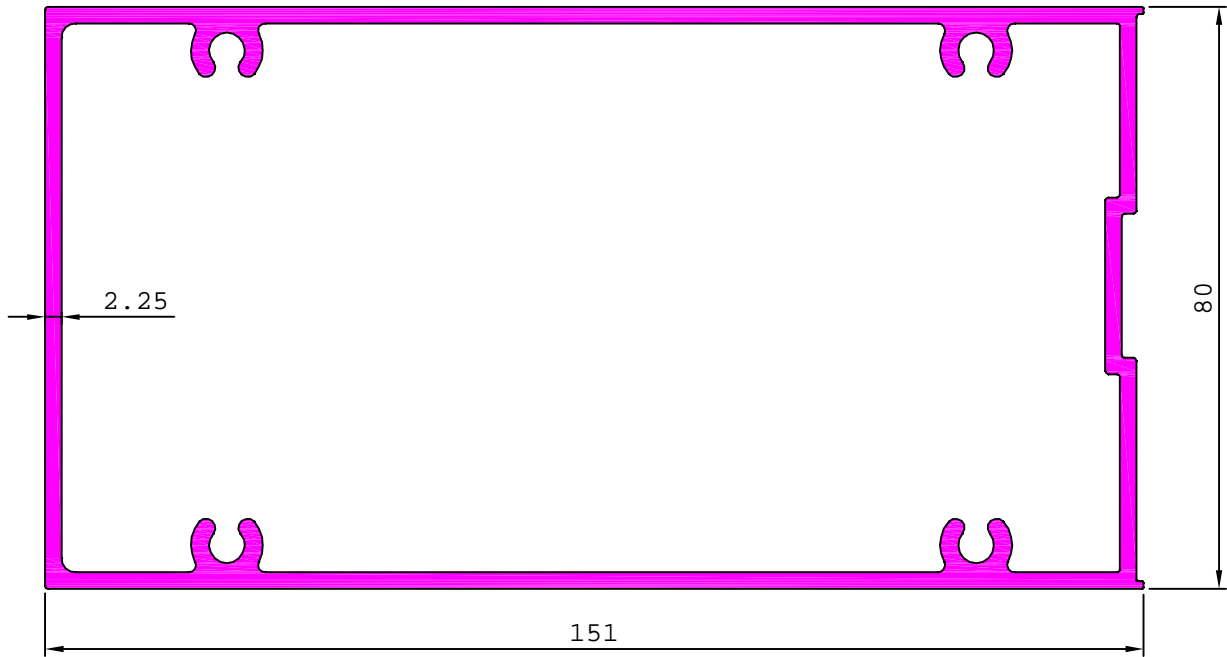

MATCHING WITH G101239

### CURTAIN WALL SECTION - 70 mm.

G101270

2.295 kg/m

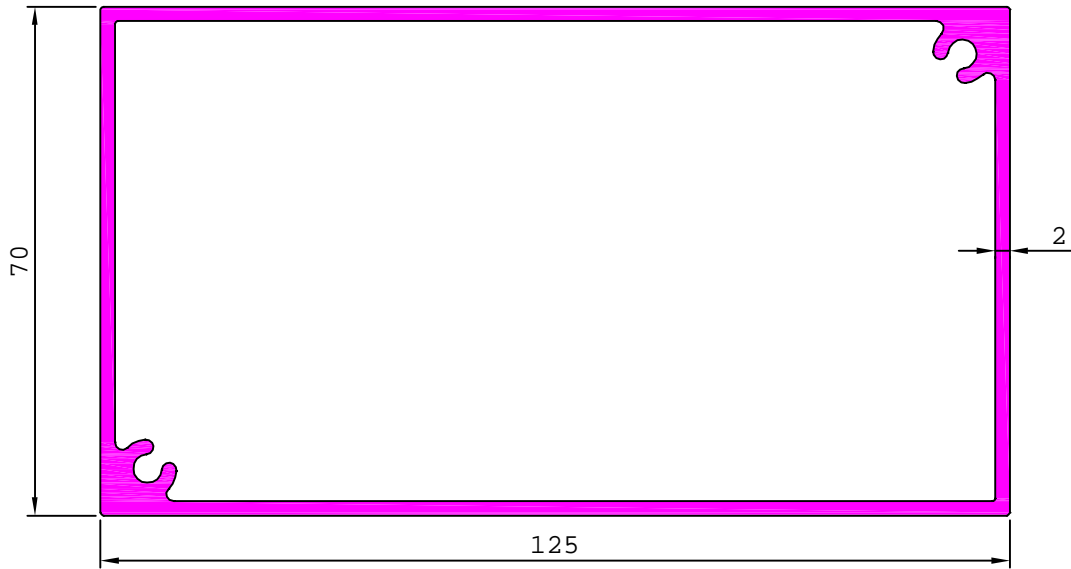

G101393

2.638 kg/m

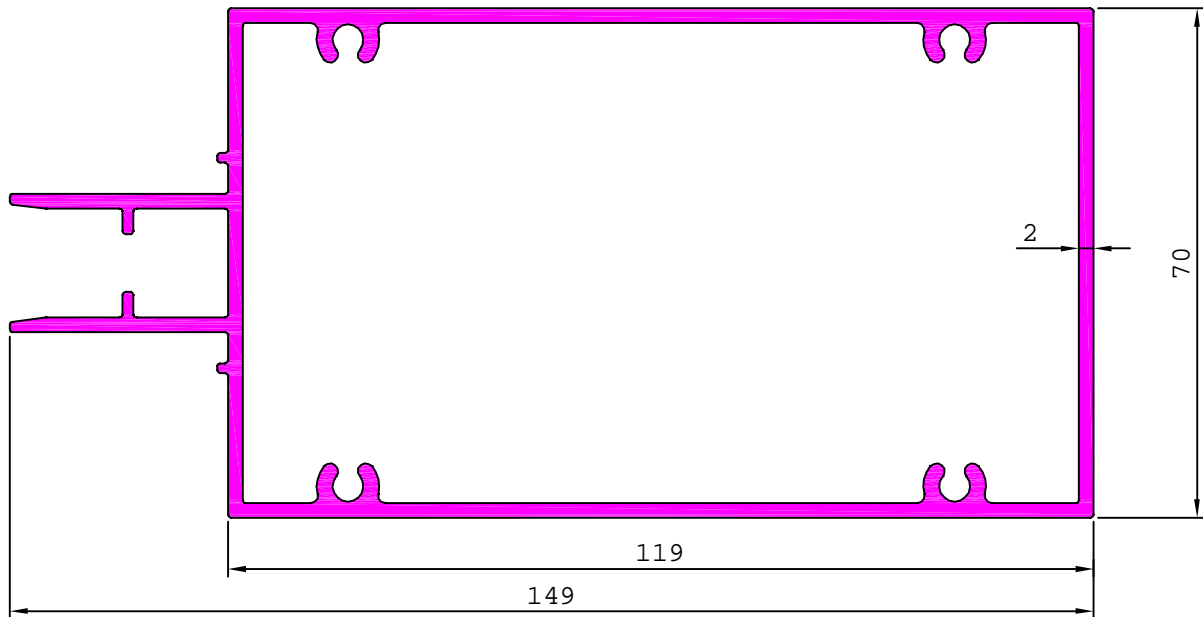

G101736

3.685 kg/m

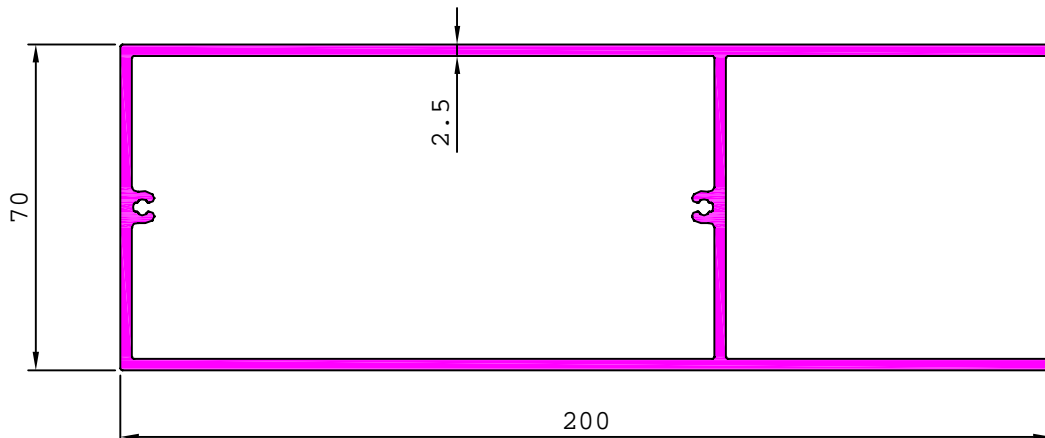

MATCHING WITH G101737

## CURTAIN WALL SECTION - 75 mm.

S6768

0.451 kg/m

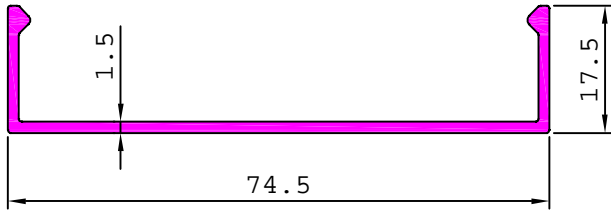

S6769

0.635 kg/m

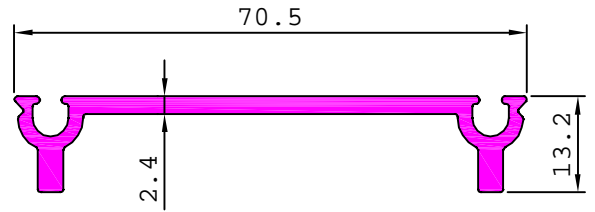

22767

0.808 kg/m

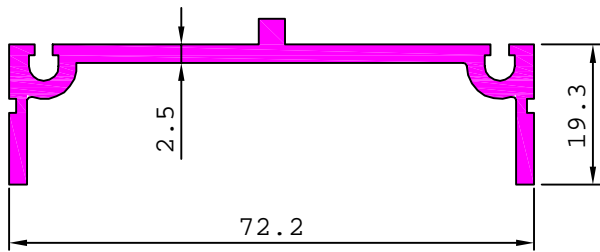

22766

0.906 kg/m

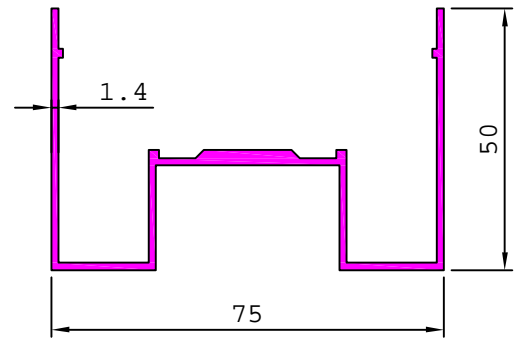

29131

5.045 kg/m

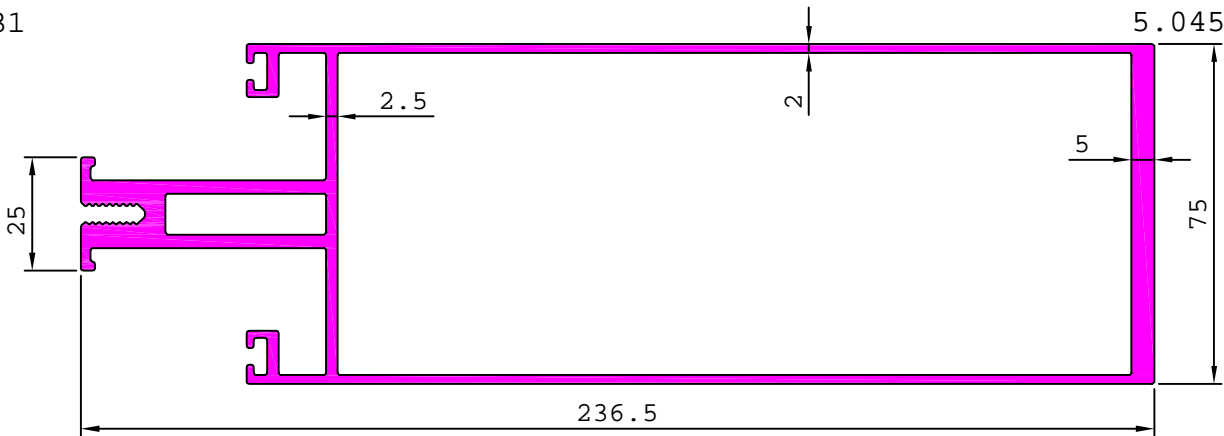

29133

3.987 kg/m

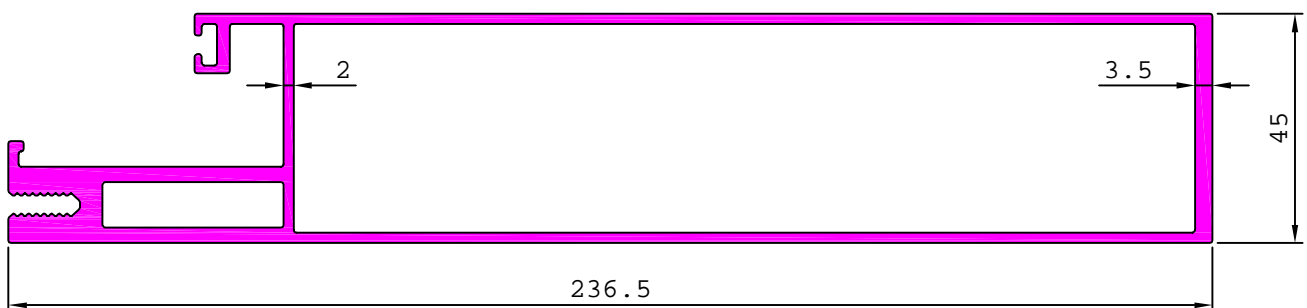

## CURTAIN WALL SECTION - 75 mm.

35682

11.697 kg/m

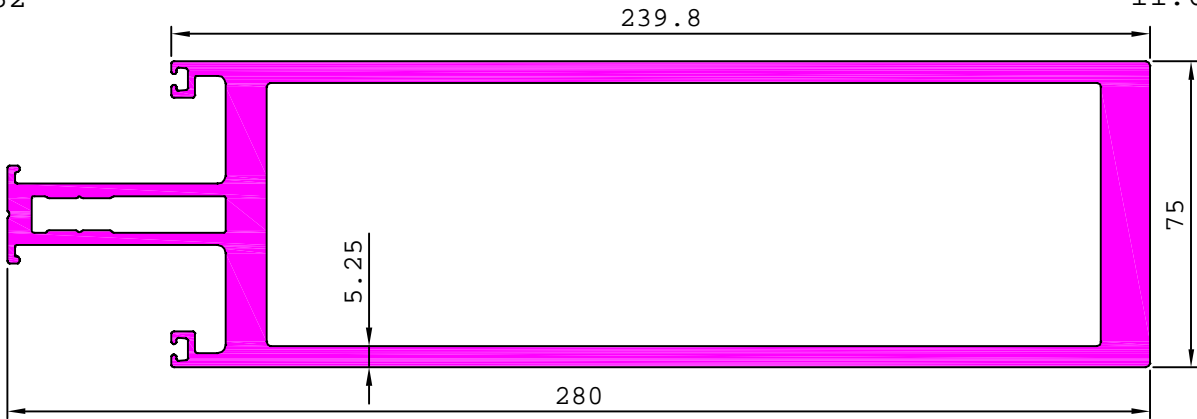

S5774

4.715 kg/m

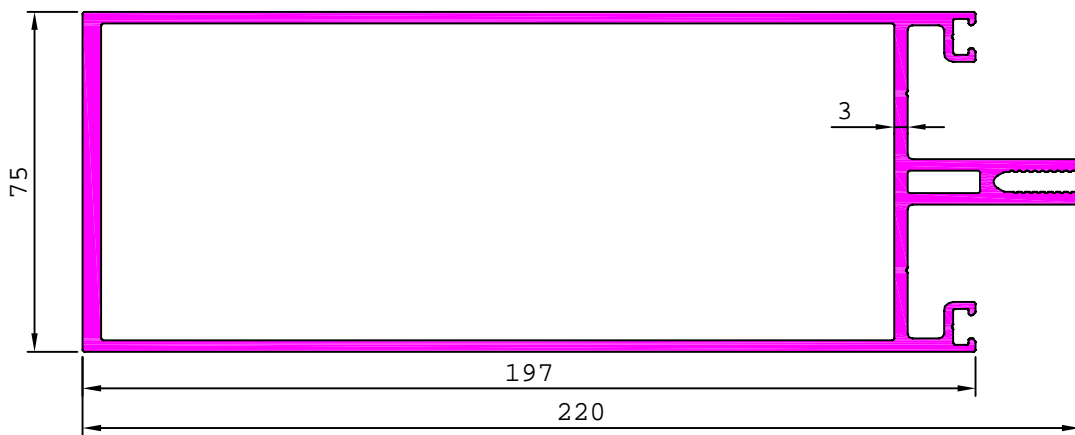

S6541

4.065 kg/m

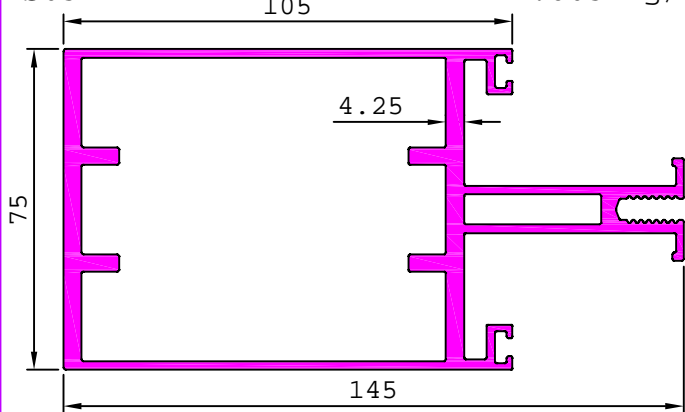

S6542

1.704 kg/m

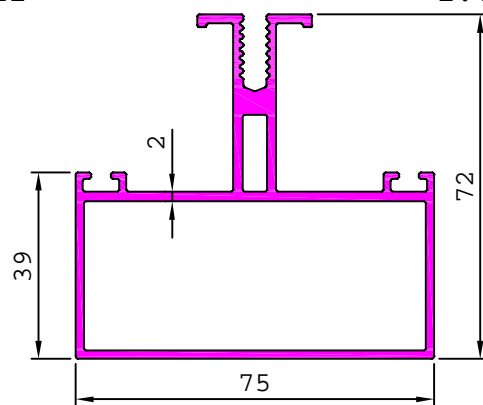

G101668

4.207 kg/m

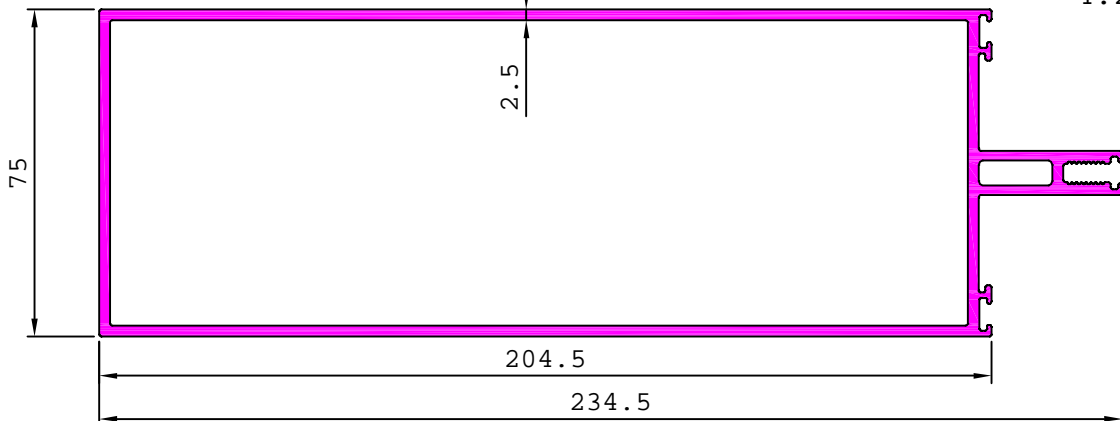

### CURTAIN WALL SECTION - 75 mm.

G101669

6.118 kg/m

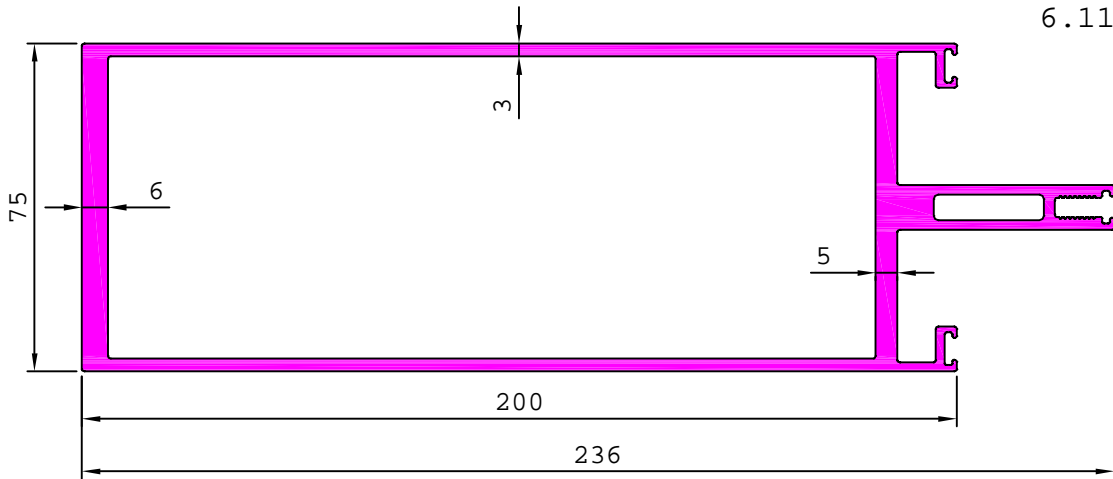

G029132

4.232 kg/m

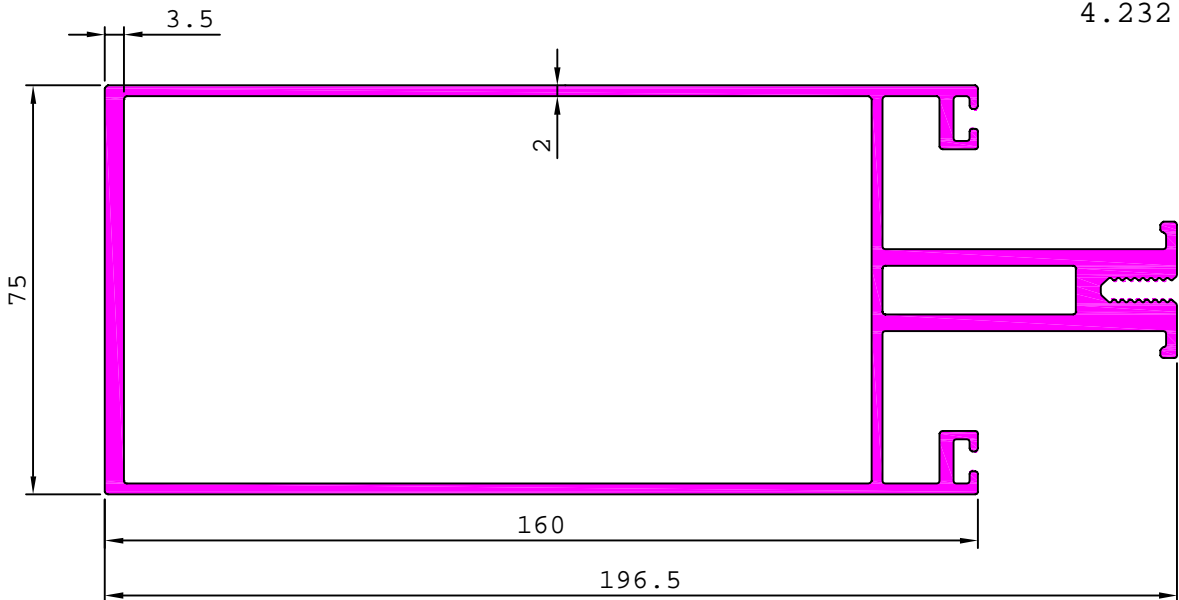

## CURTAIN WALL SECTION - 80 mm.

36062

0.609 kg/m

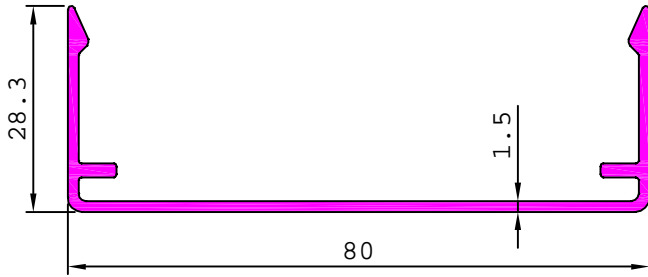

MATCHING WITH 36063

36063

2.014 kg/m

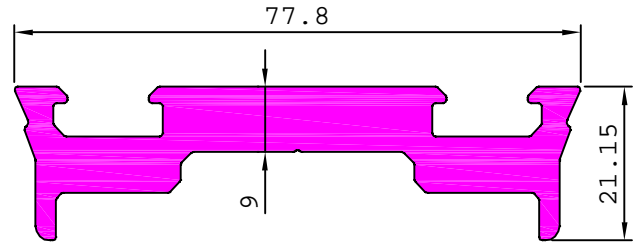

MATCHING WITH 36062

22826

0.618 kg/m

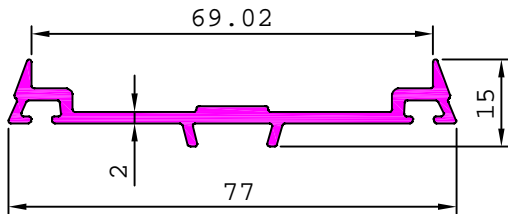

MATCHING WITH 22825

22825

0.528 kg/m

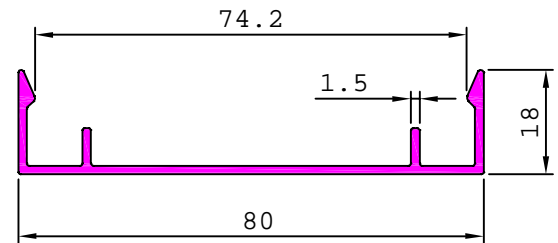

MATCHING WITH 22826

36064

0.513 kg/m

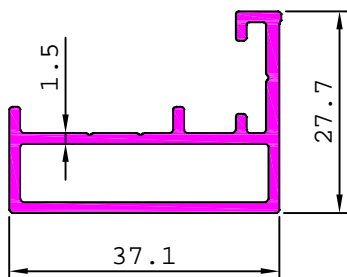

41508

0.066 kg/m

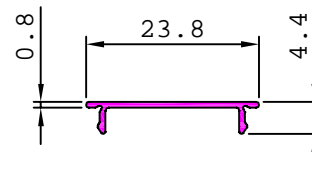

MATCHING WITH 36061

G100763

0.090 kg/m

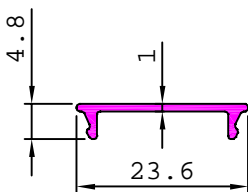

MATCHING WITH G100761

**CURTAIN WALL SECTION - 80 mm.**

36061

14.464 kg/m

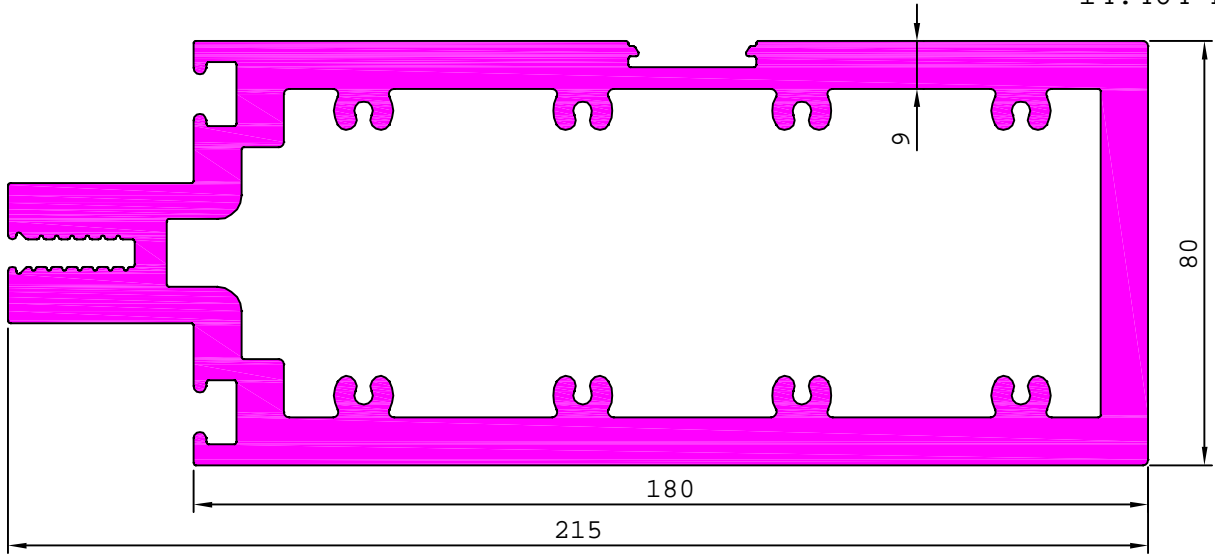

36060

11.131 kg/m

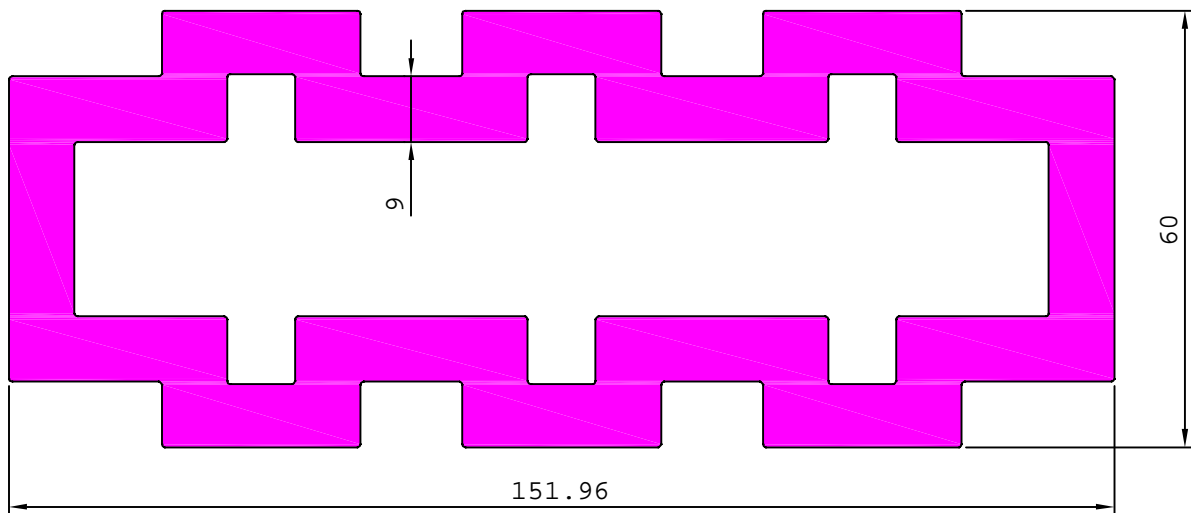

22819

1.971 kg/m

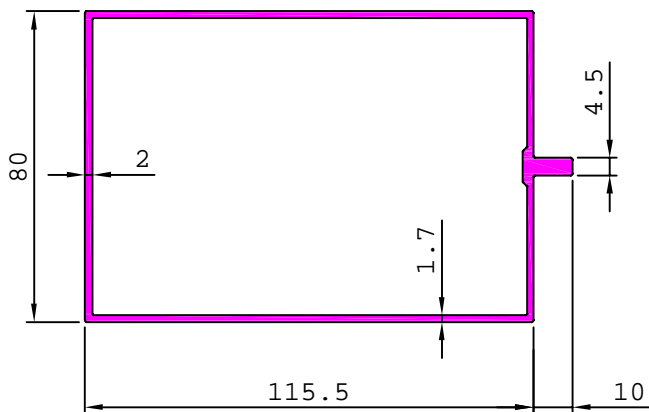

22823

2.848 kg/m

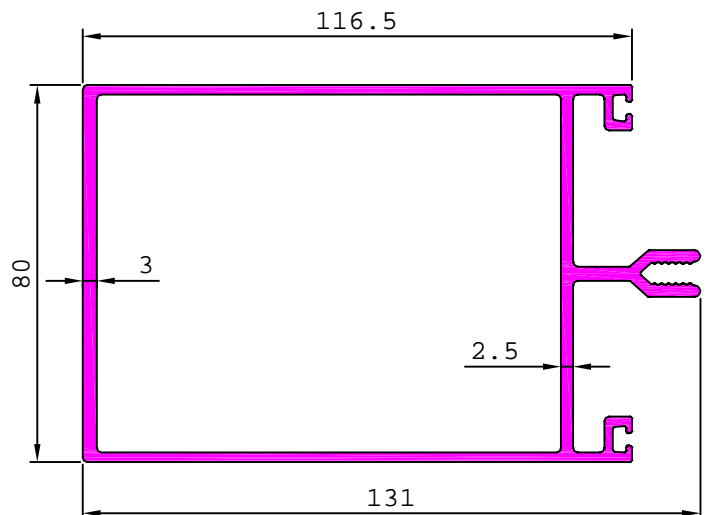

## CURTAIN WALL SECTION - 80 mm.

35898

3.067 kg/m

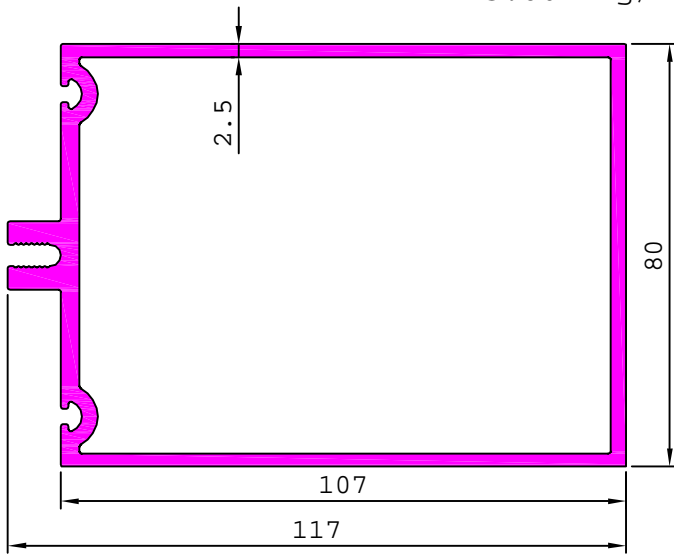

29099

2.473 kg/m

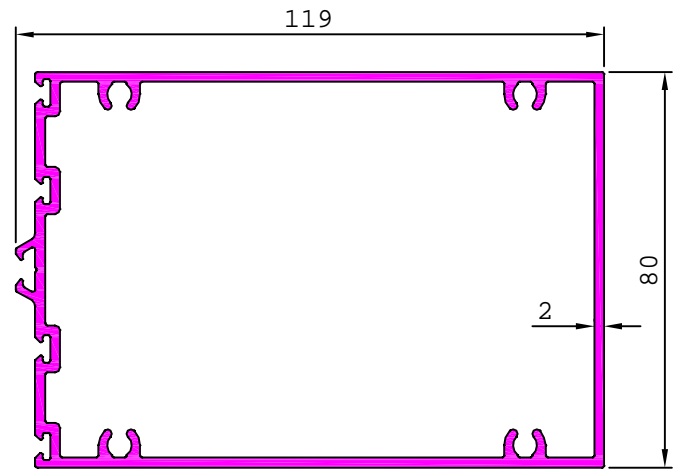

35749

2.649 kg/m

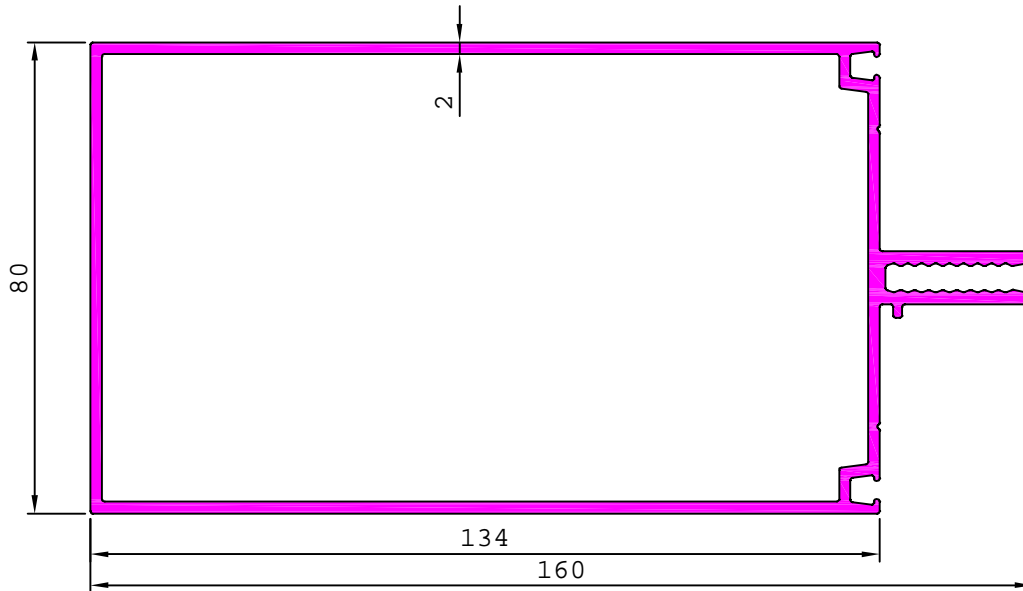

28911

2.432 kg/m

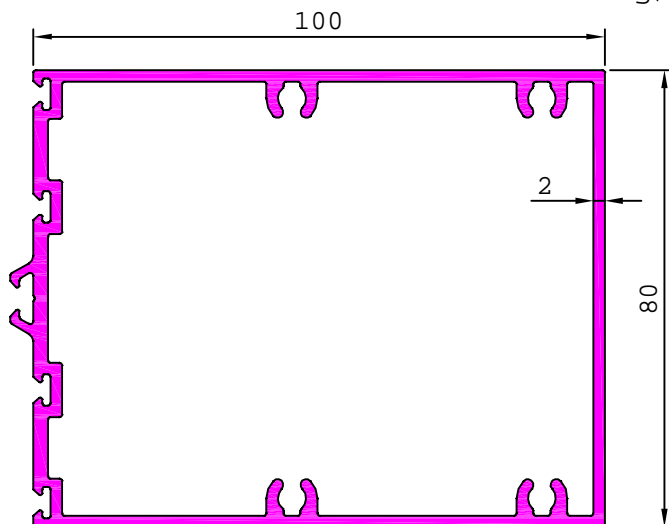

### CURTAIN WALL SECTION - 80 mm.

35899

5.625 kg/m

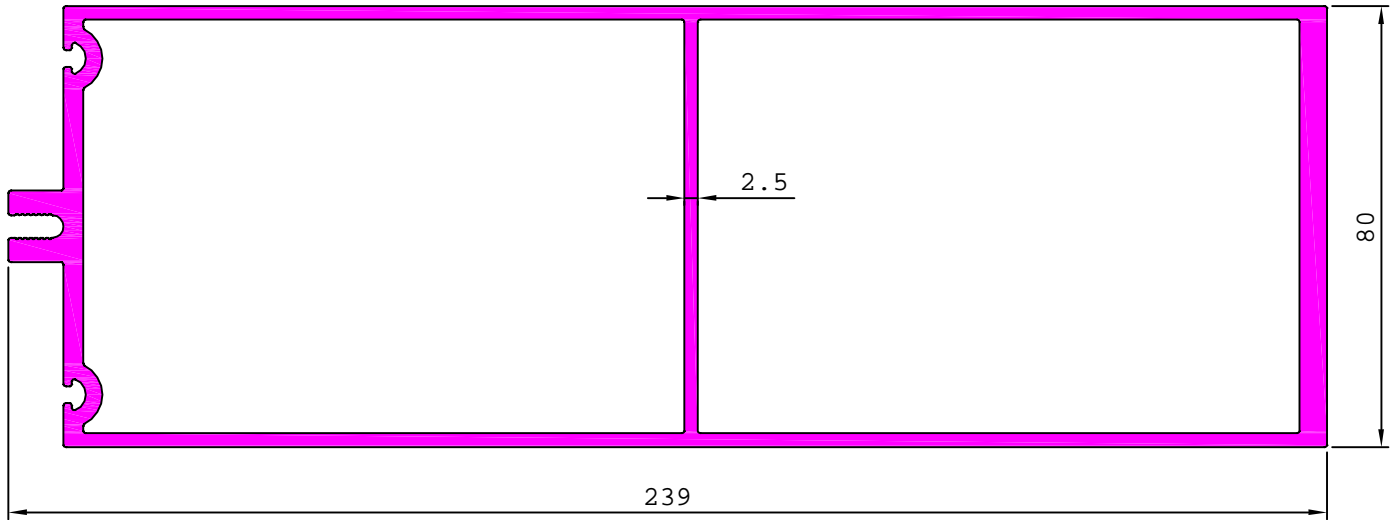

S6696

2.896 kg/m

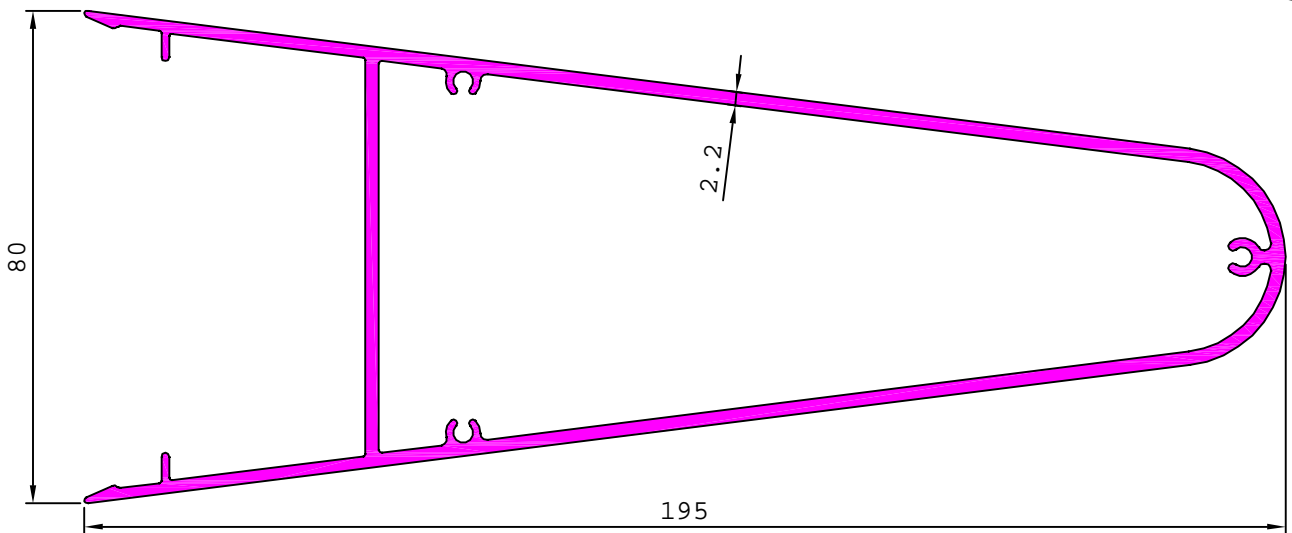

MATCHING WITH 22826

G101214

3.782 kg/m

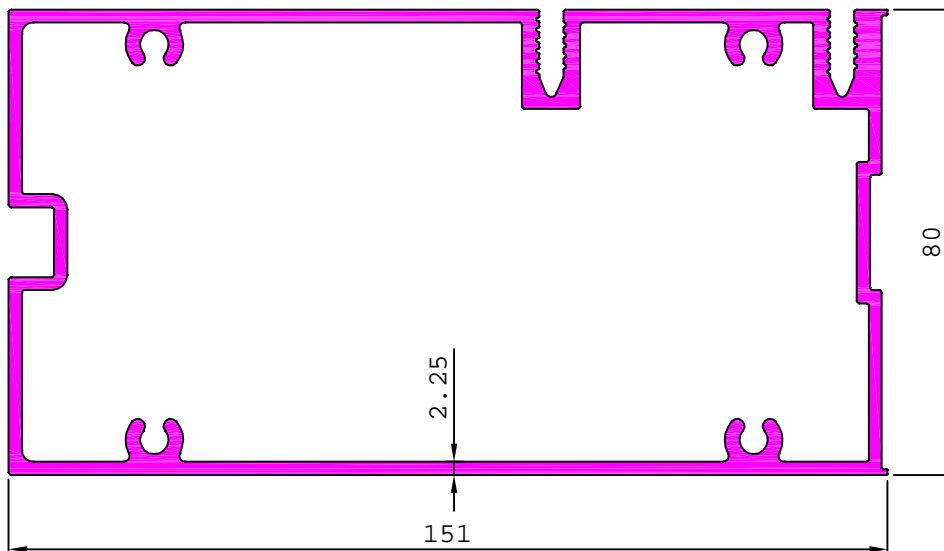

MATCHING WITH G101239

## CURTAIN WALL SECTION - 80 mm.

G101295

2.731 kg/m

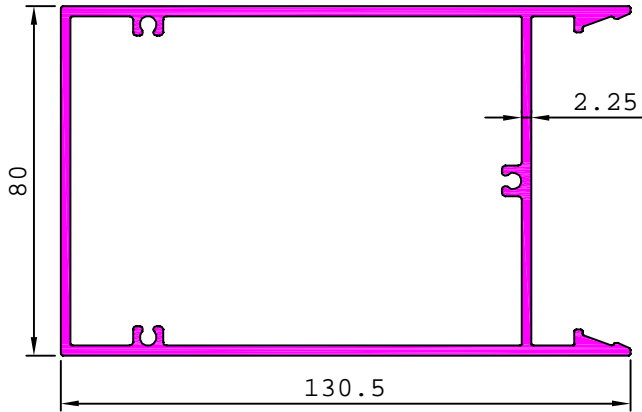

G101433

2.390 kg/m

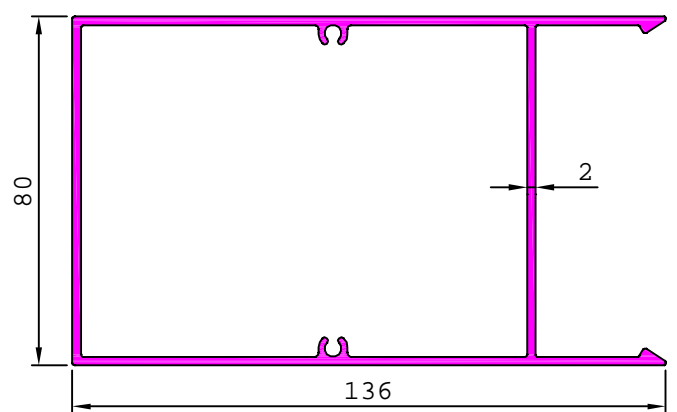

G101296

3.333 kg/m

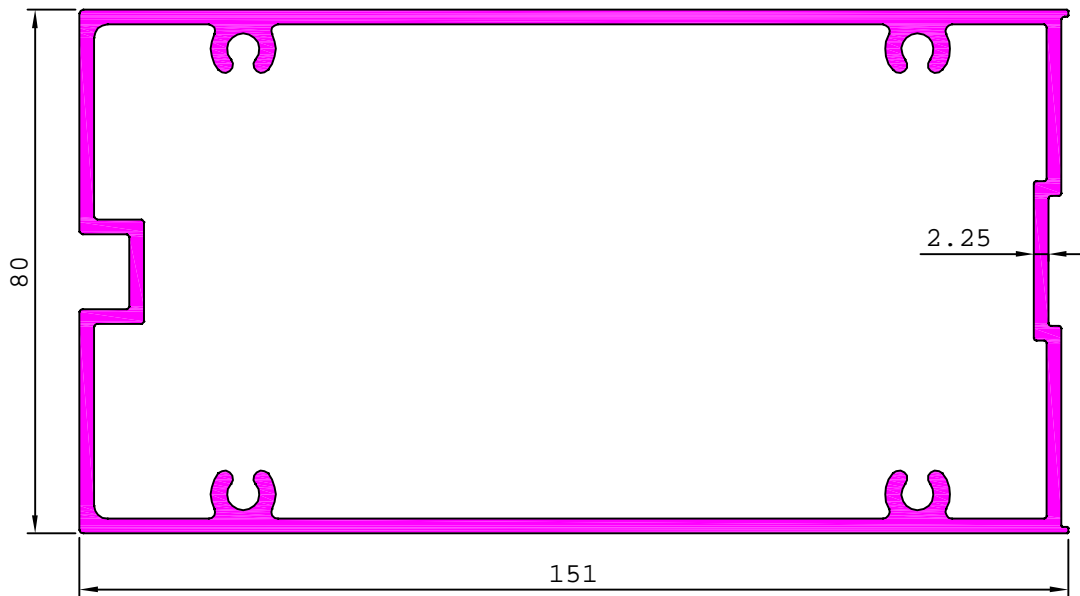

MATCHING WITH G101239

G101428

2.812 kg/m

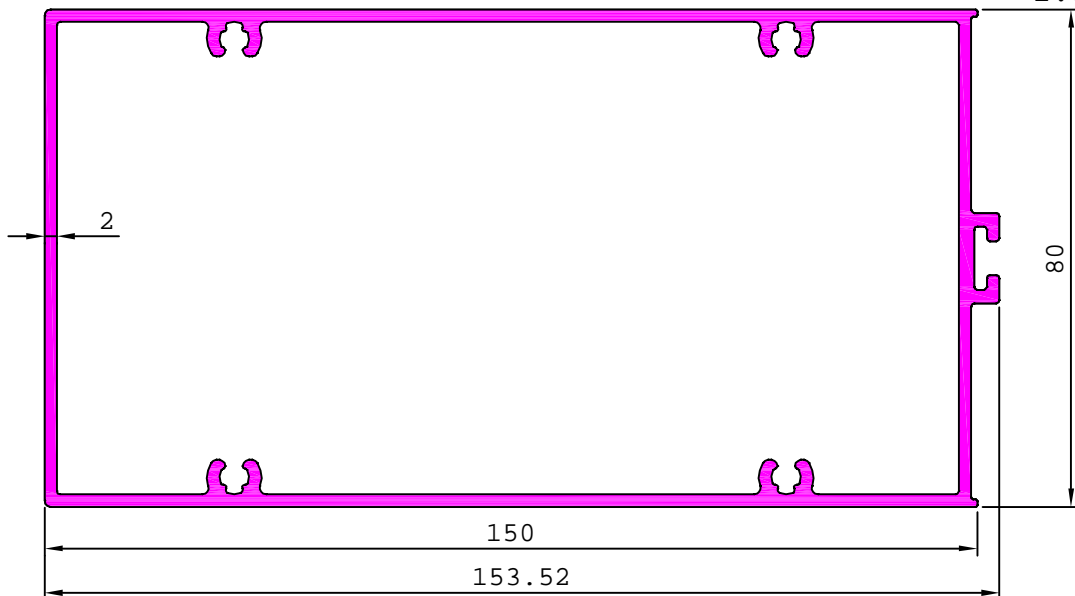

## CURTAIN WALL SECTION - 80 mm.

G101429

3.169 kg/m

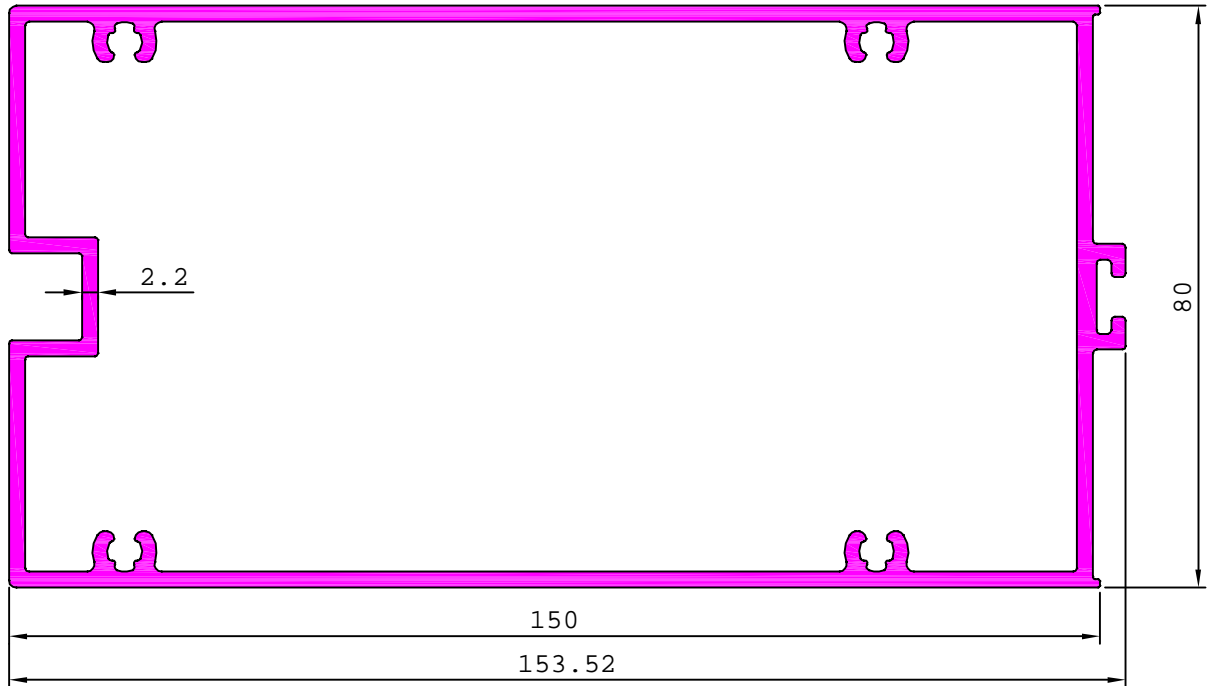

## CURTAIN WALL SECTION - 90 mm.

S6284

0.560 kg/m

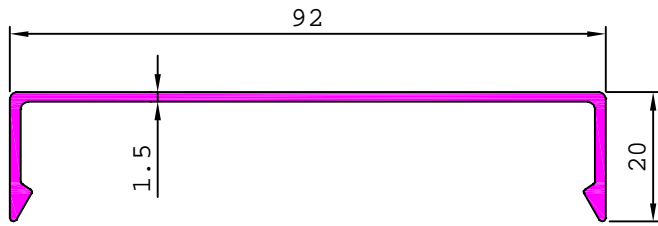

S6285

0.886 kg/m

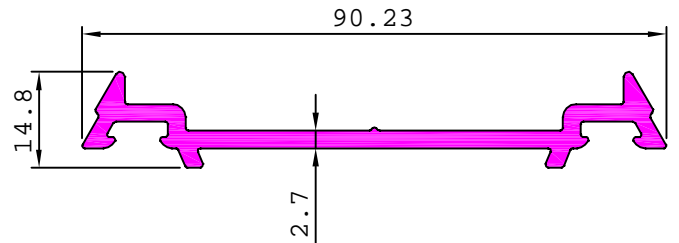

S6287

2.881 kg/m

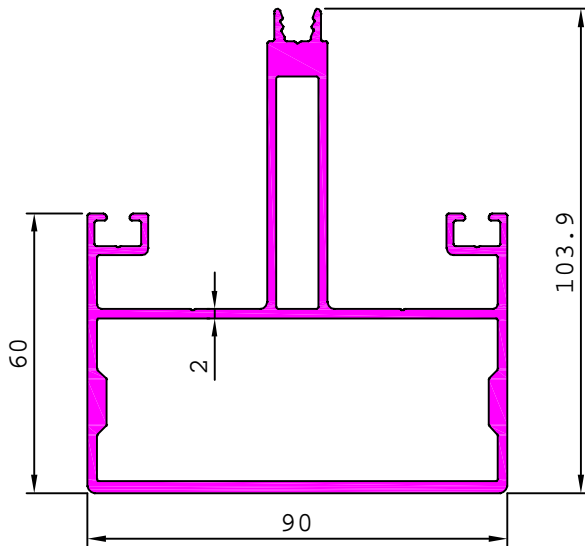

S6286

2.574 kg/m

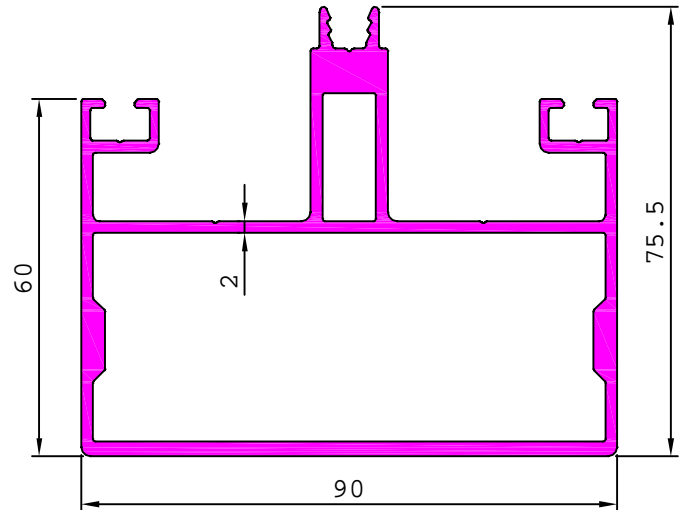

## CURTAIN WALL SECTION-A

35995

4.449 kg/m

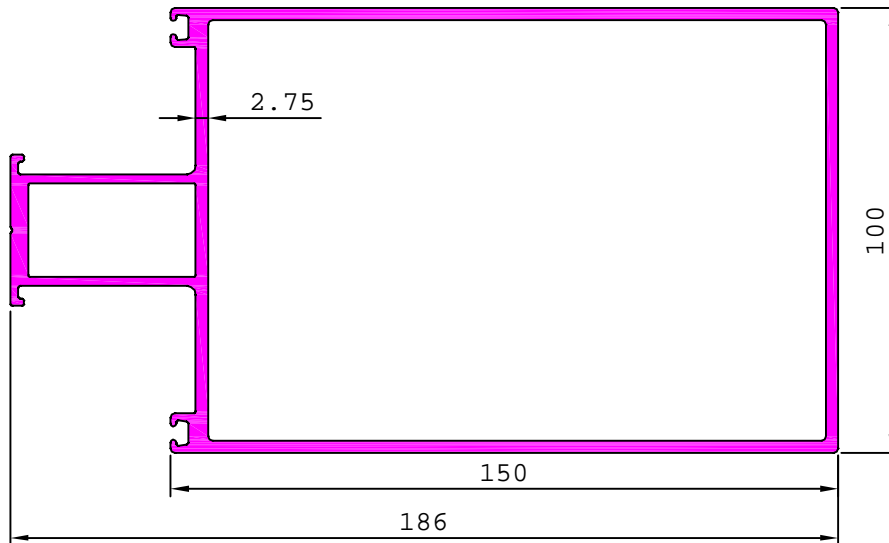

35996

4.521 kg/m

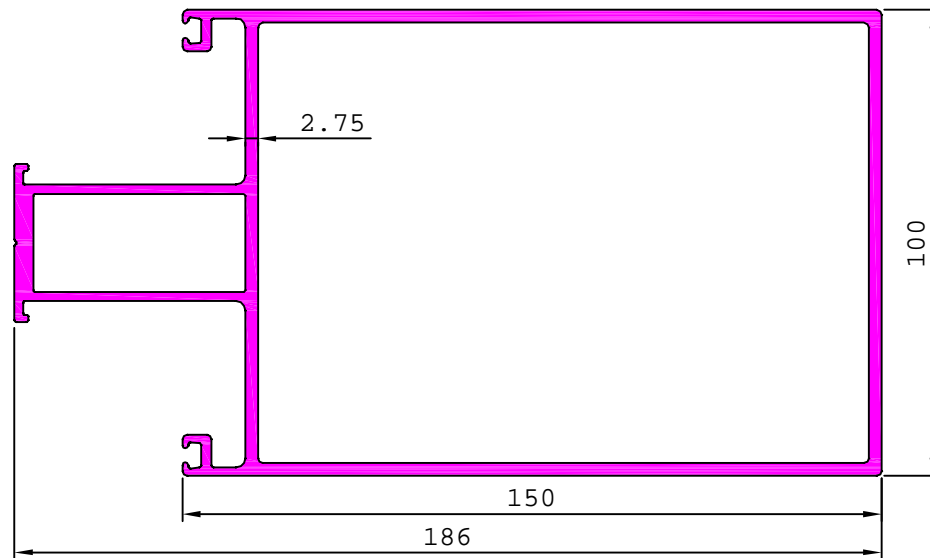

35997

1.101 kg/m

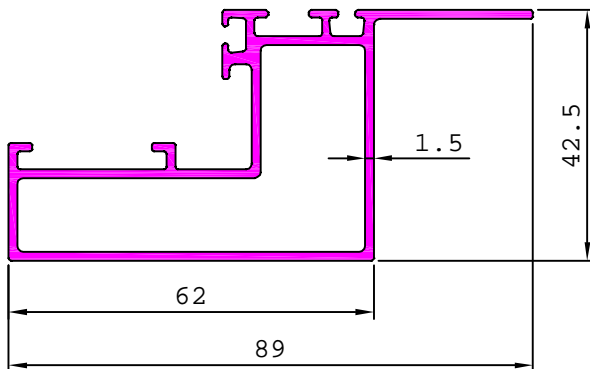

**MATCHING WITH 35784**

## CURTAIN WALL SECTION-B

36177

0.217 kg/m

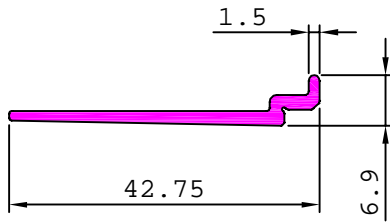

36174

1.334 kg/m

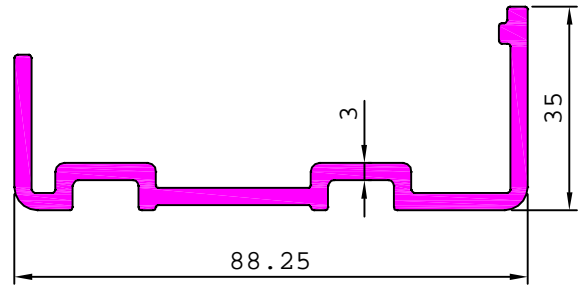

MATCHING WITH S5704,S5705,S5707,S5708,S5709

S5705

2.607 kg/m

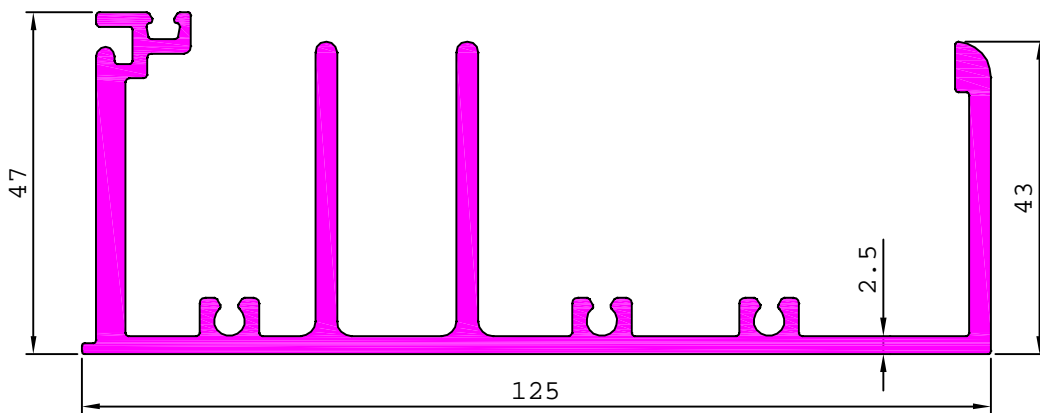

S5707

2.402 kg/m

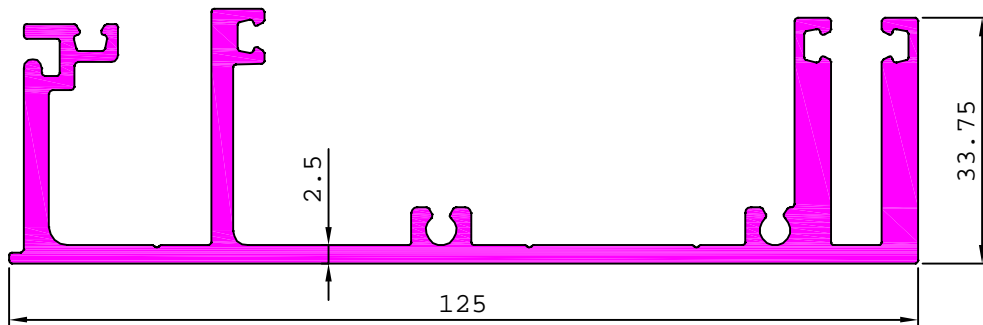

S5708

2.509 kg/m

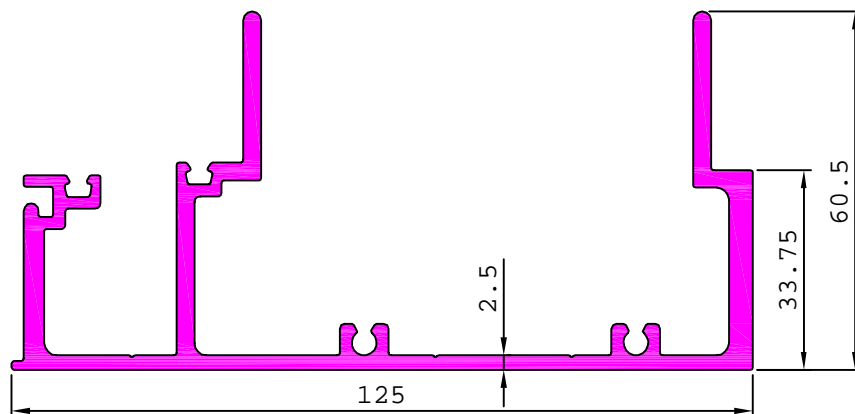

**CURTAIN WALL SECTION-B**

S5709

3.453 kg/m

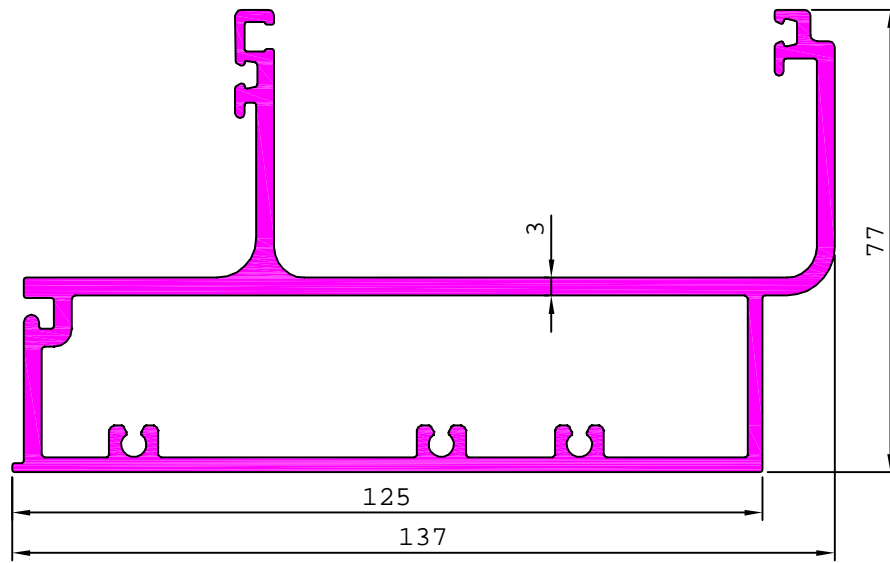

S5704

2.558 kg/m

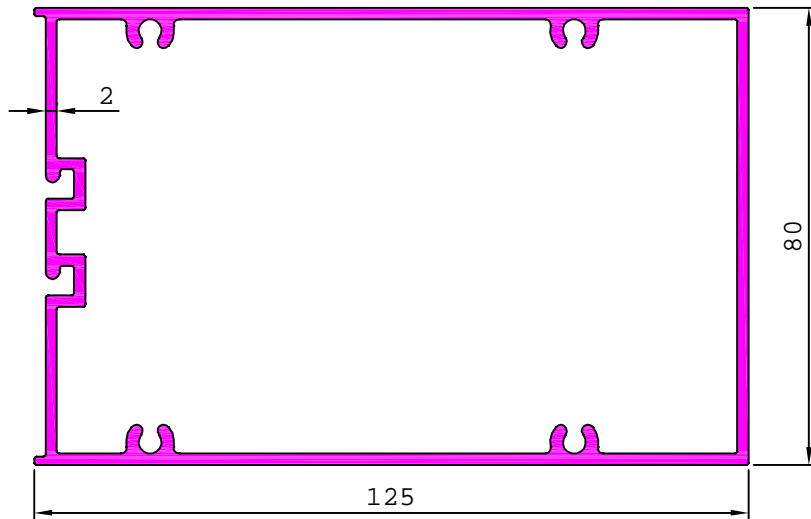

**MATCHING WITH S5689**

36175

0.809 kg/m

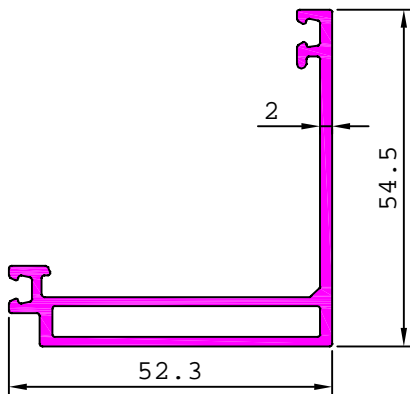

36176

1.388 kg/m

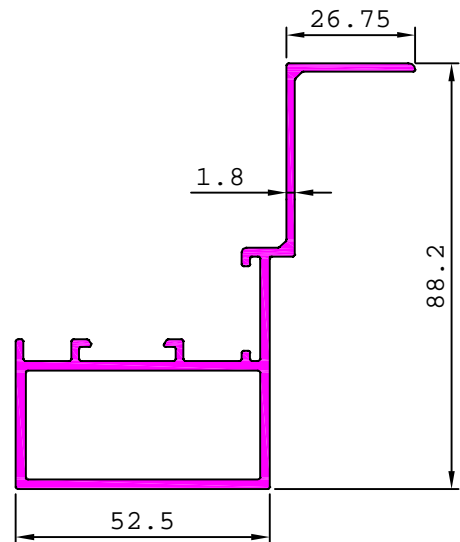

### CURTAIN WALL SECTION-B

36178

3.793 kg/m

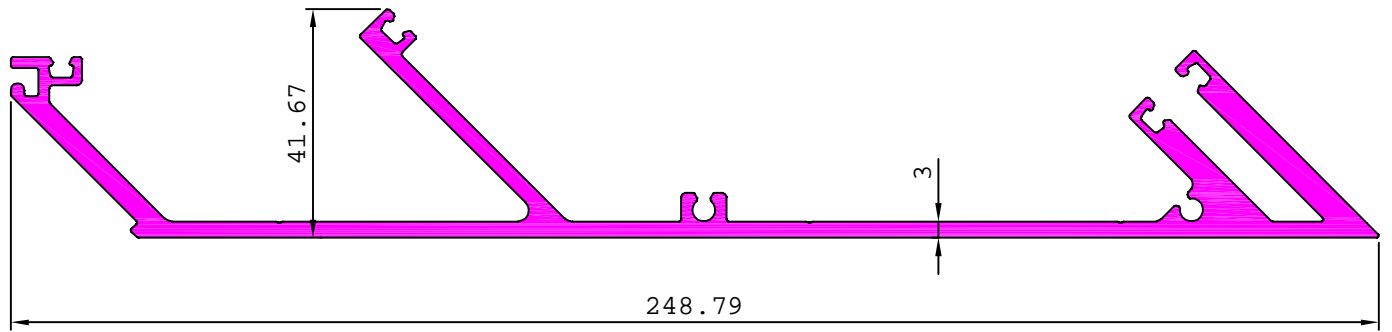

36179

4.121 kg/m

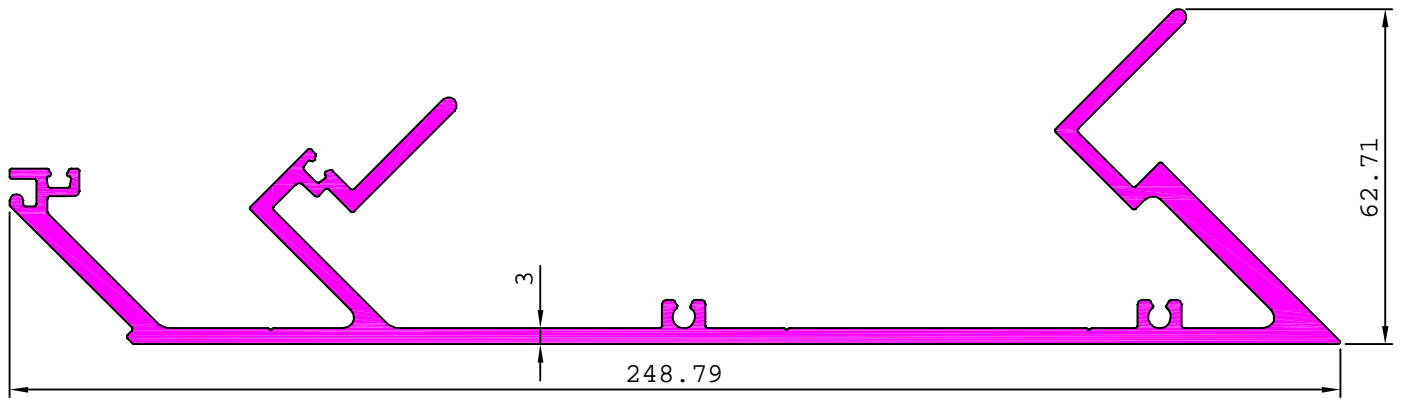

G100666

2.662 kg/m

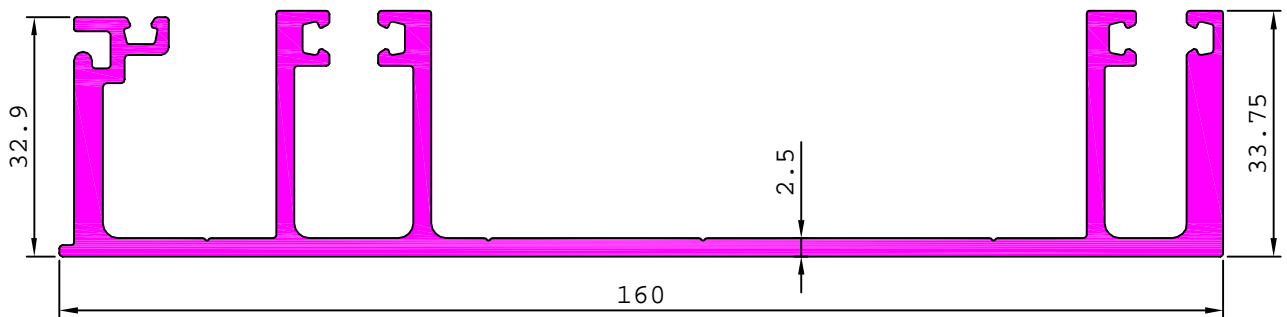

## CURTAIN WALL SECTION-C

36021

0.180 kg/m

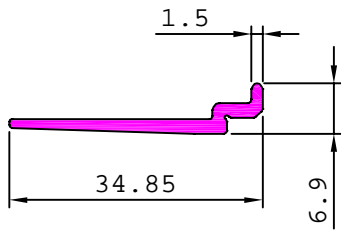

MATCHING WITH 36019,36020,36170,36171

36173

1.480 kg/m

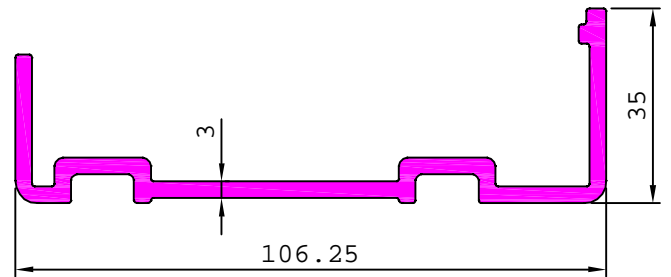

MATCHING WITH 36172

36017

0.614 kg/m

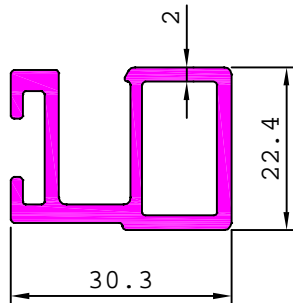

36079

0.157 kg/m

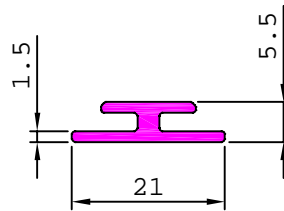

36167

0.404 kg/m

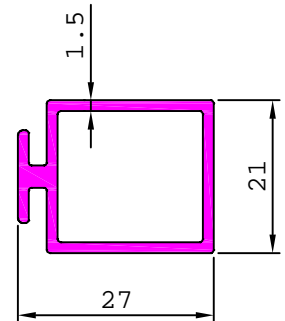

36019

2.680 kg/m

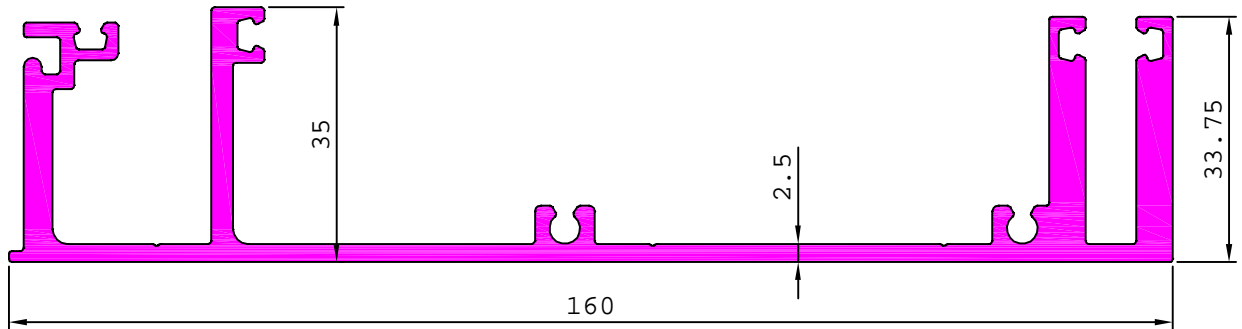

36170

2.843 kg/m

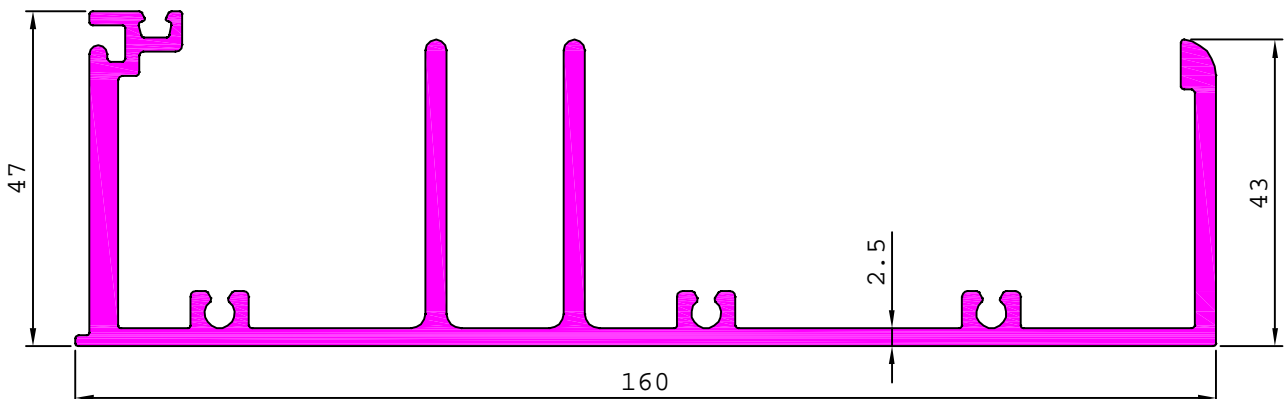

**CURTAIN WALL SECTION-C**

36020

2.850 kg/m

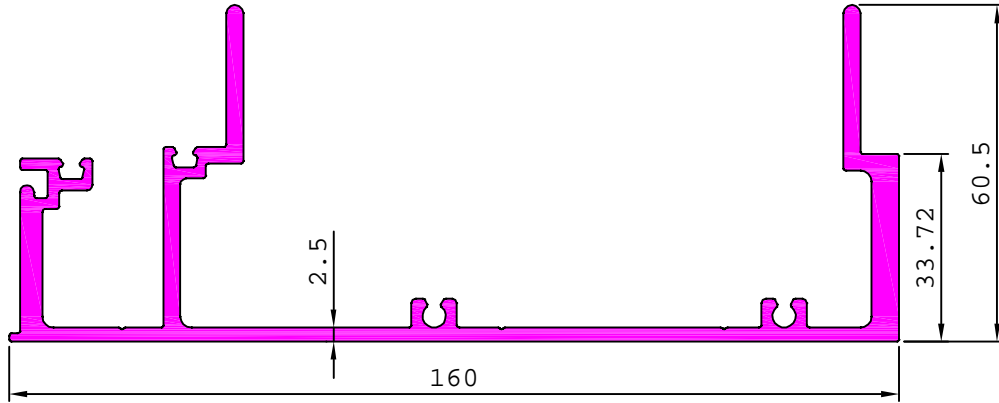

36171

3.195 kg/m

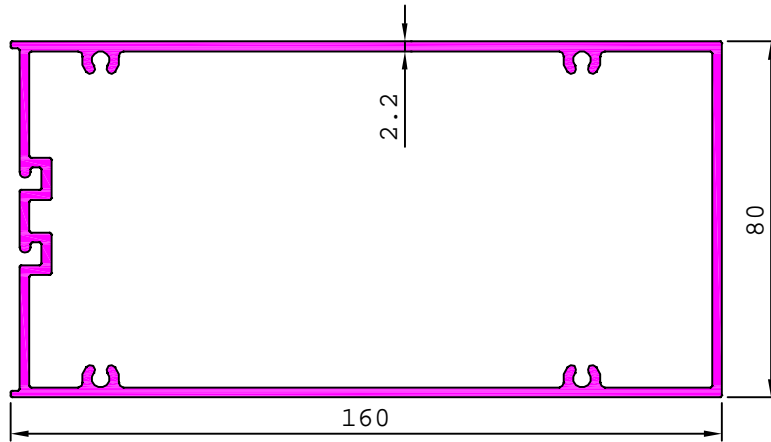

36080

1.490 kg/m

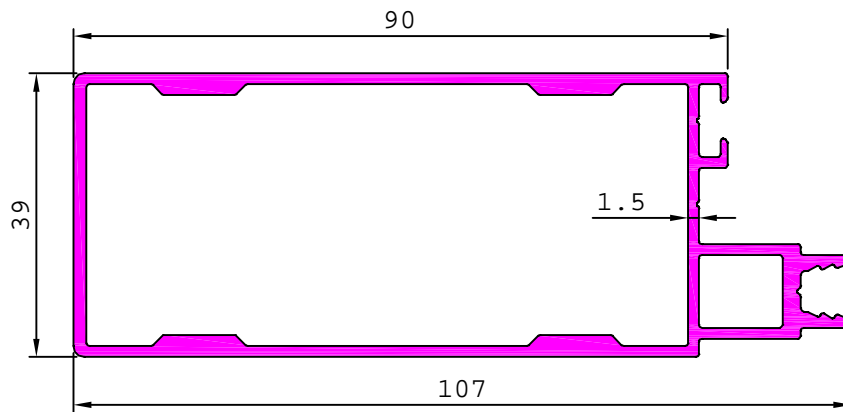

36018

2.494 kg/m

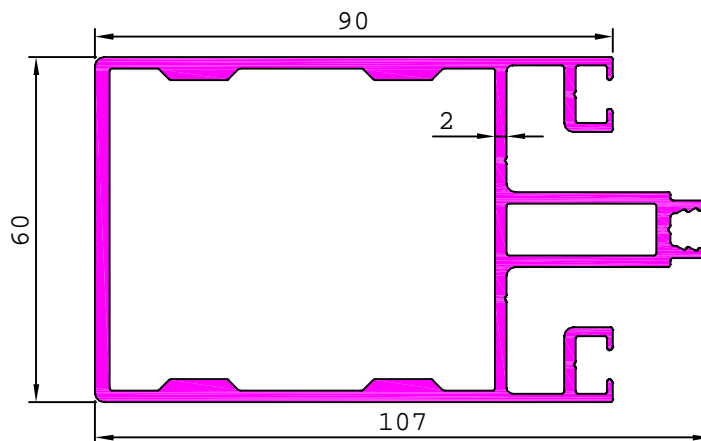

### CURTAIN WALL SECTION-C

36172

3.972 kg/m

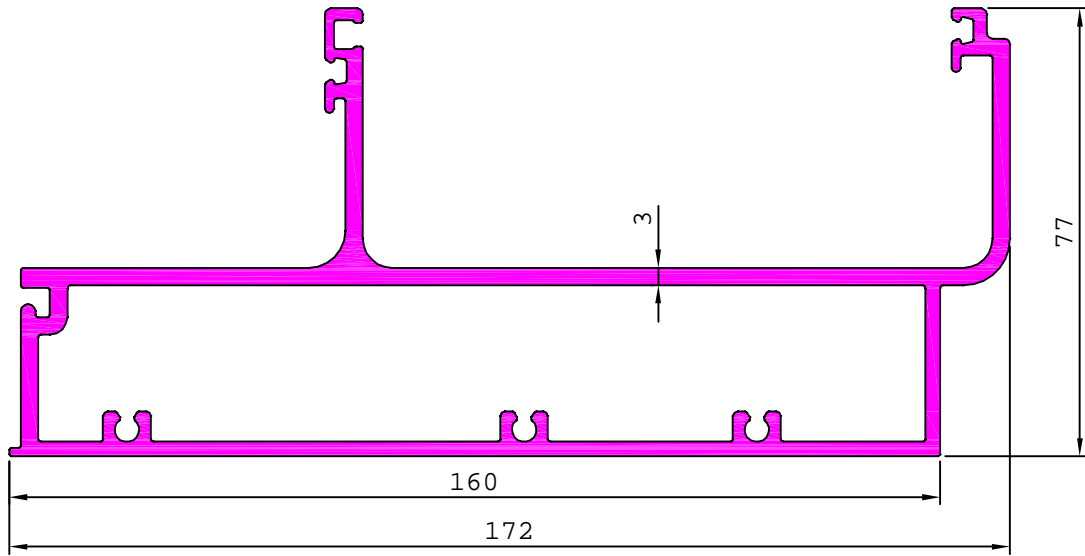

## CURTAIN WALL SECTION-D

S5545 1.297 kg/m

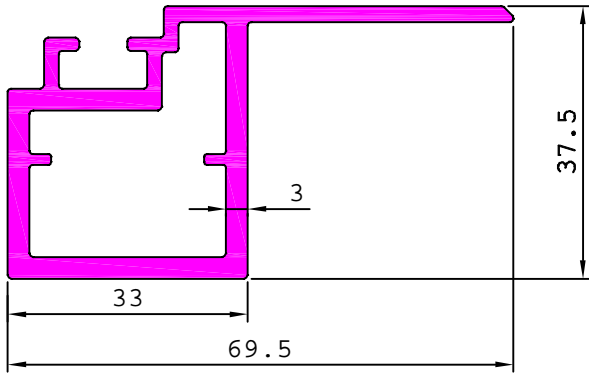

MATCHING WITH S5589

S5546 1.535 kg/m

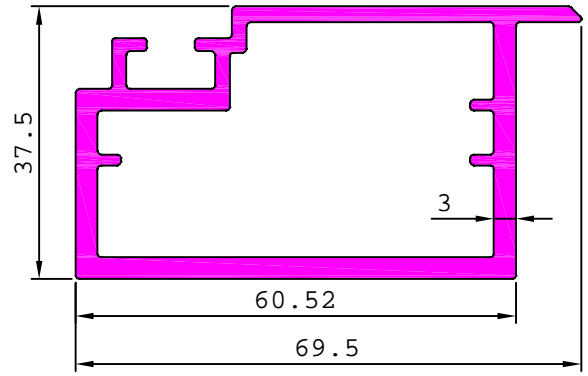

MATCHING WITH S5589

36147 2.376 kg/m

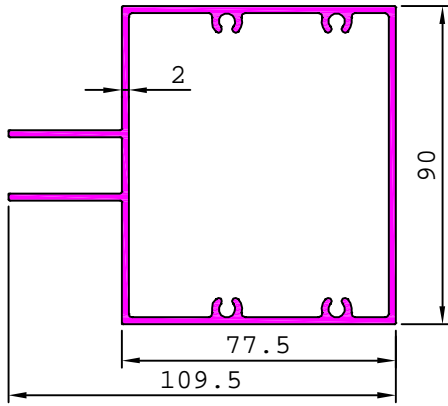

S5589 0.369 kg/m

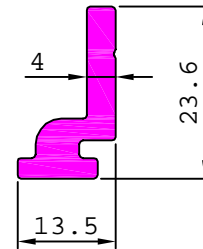

MATCHING WITH S5545 & S5546

36054

3.086 kg/m

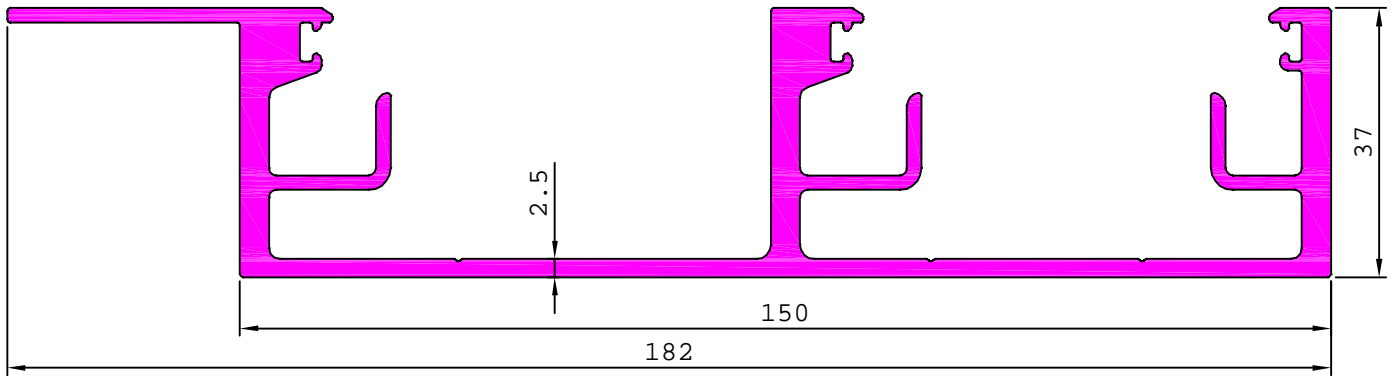

36148

2.043 kg/m

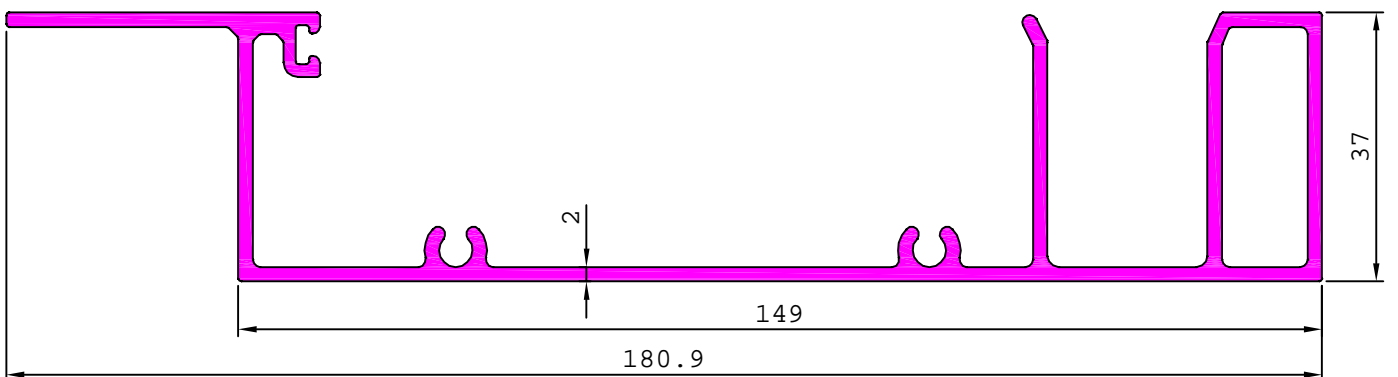

### CURTAIN WALL SECTION-D

36055

3.766 kg/m

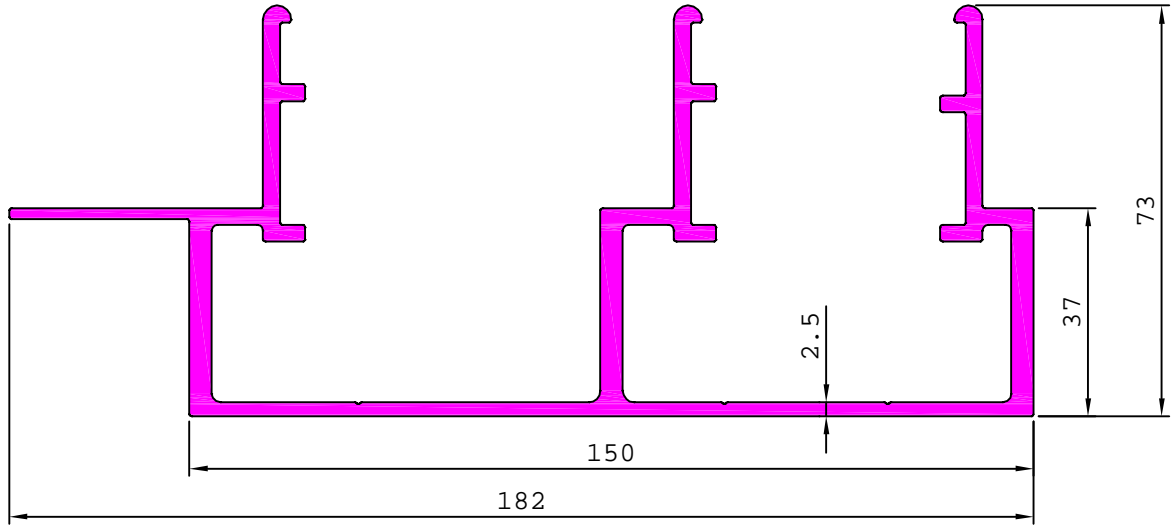

36146

2.876 kg/m

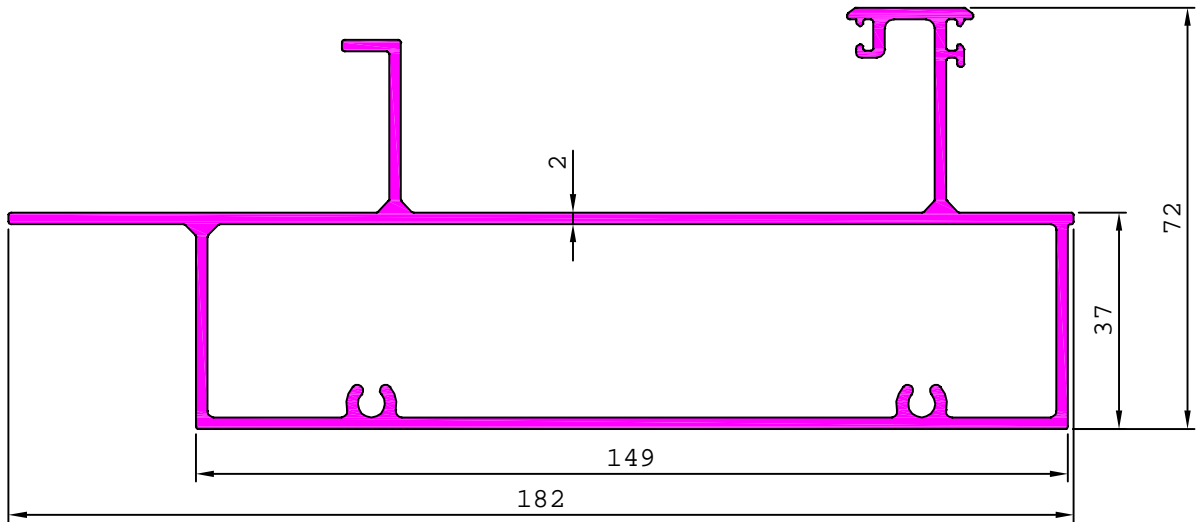

## CURTAIN WALL SECTION-E

S5739

2.549 kg/m

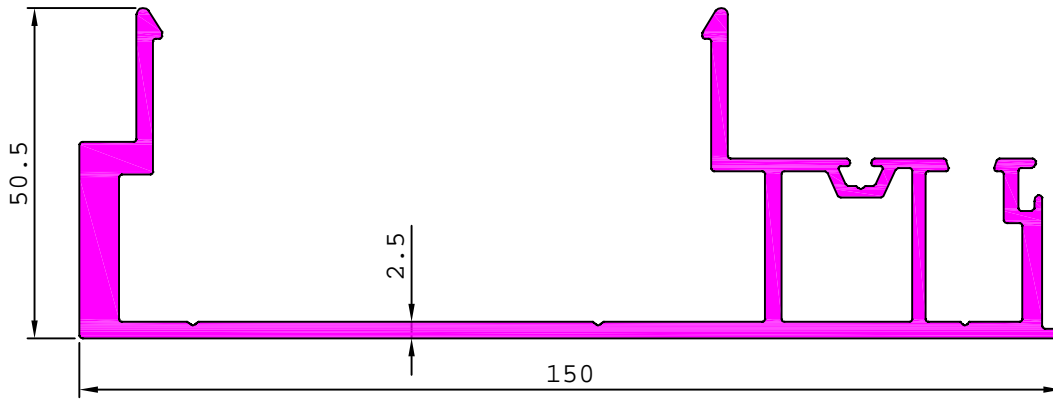

S5740

2.054 kg/m

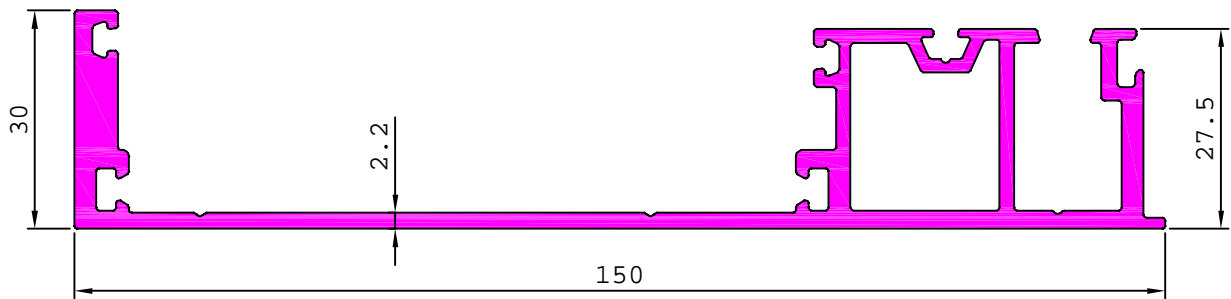

S5741

0.347 kg/m

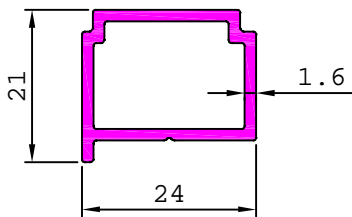

S4666

0.804 kg/m

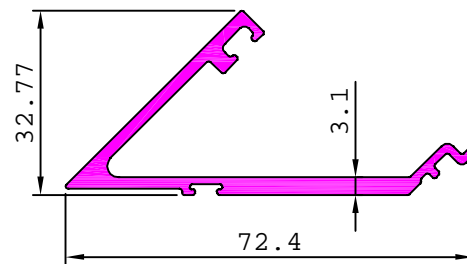

## CURTAIN WALL SECTION-F

S5787

0.193 kg/m

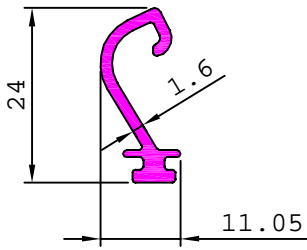

MATCHING WITH S5785,S5786

S5779

1.248 kg/m

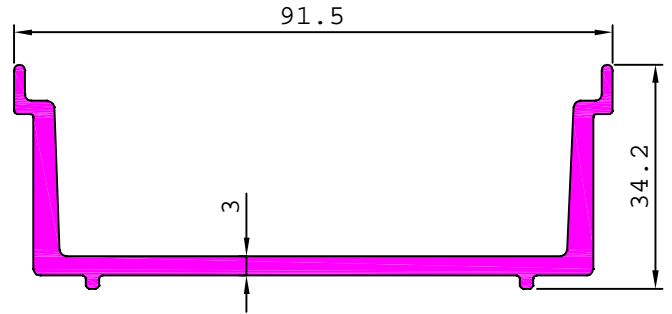

S5778

1.696 kg/m

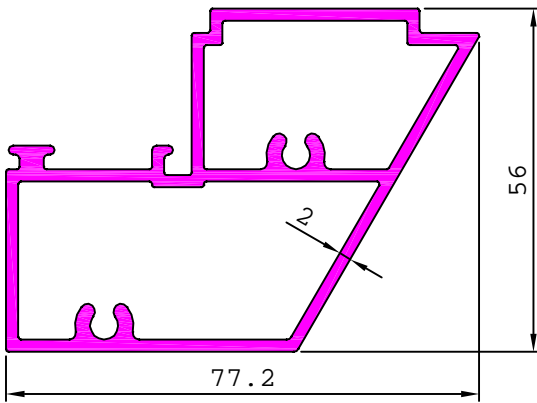

S5780

0.969 kg/m

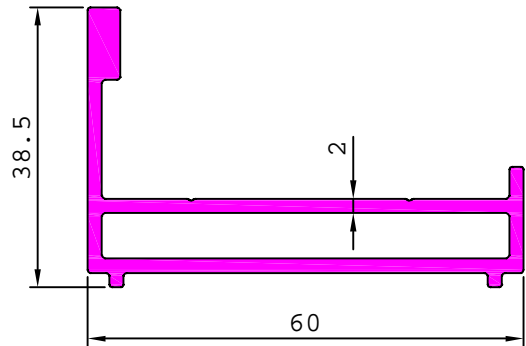

S5781

0.947 kg/m

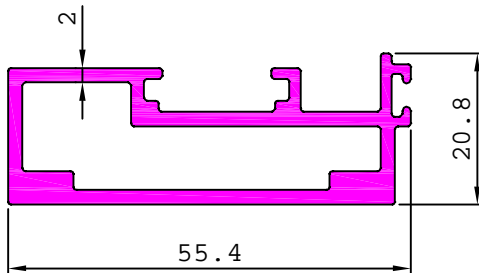

S5782

0.594 kg/m

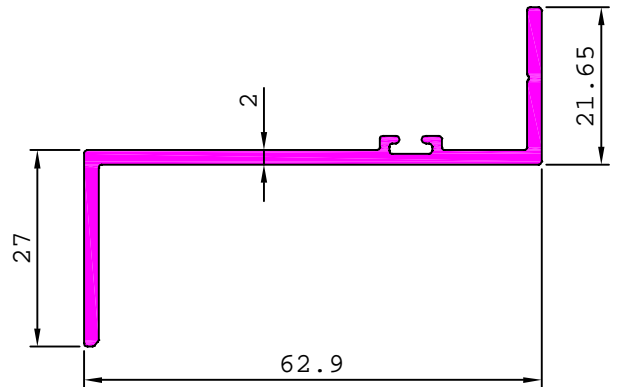

S5783

0.502 kg/m

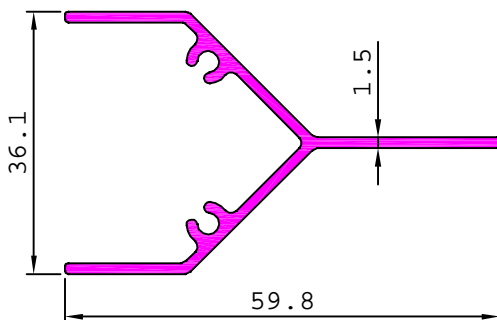

S5784

3.289 kg/m

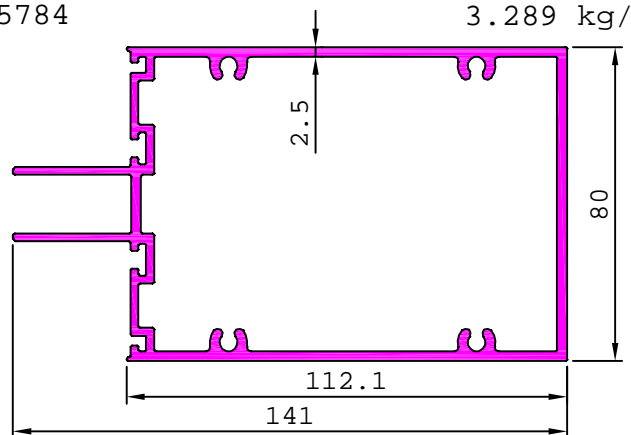

**CURTAIN WALL SECTION-F**

S5785

1.882 kg/m

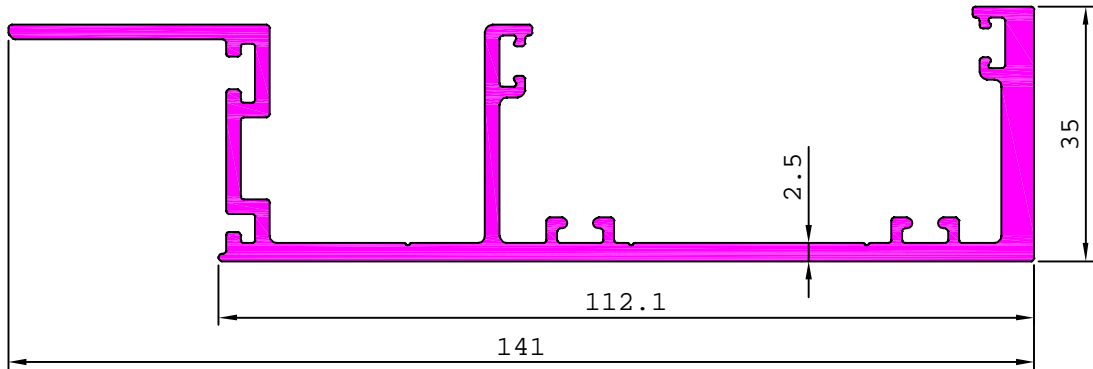

S5788

2.646 kg/m

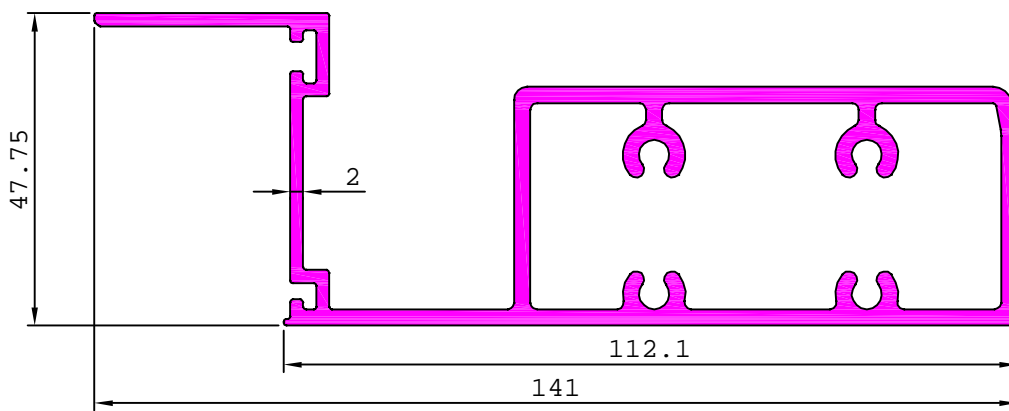

S5786

2.299 kg/m

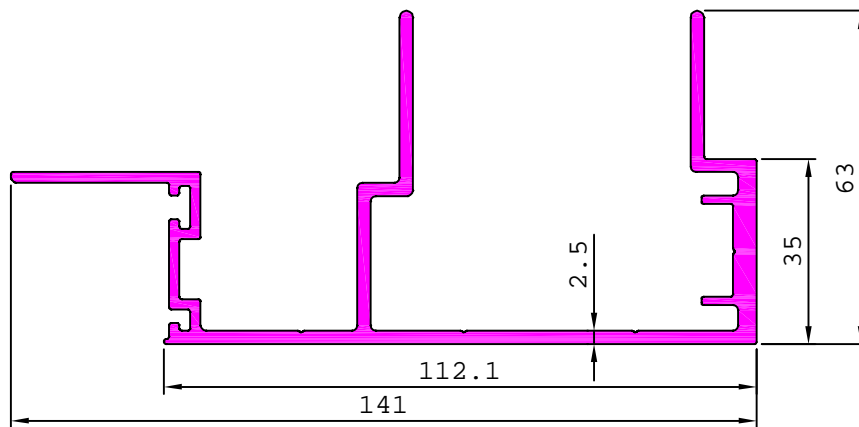

S5789

3.820 kg/m

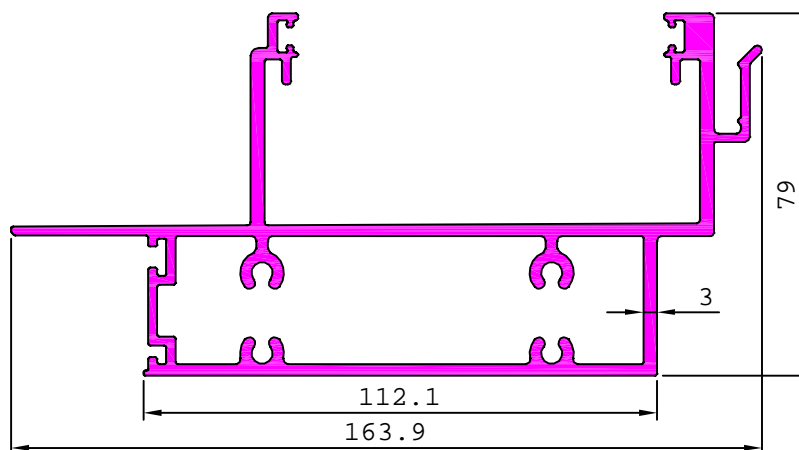

### CURTAIN WALL SECTION-G

36126

3.380 kg/m

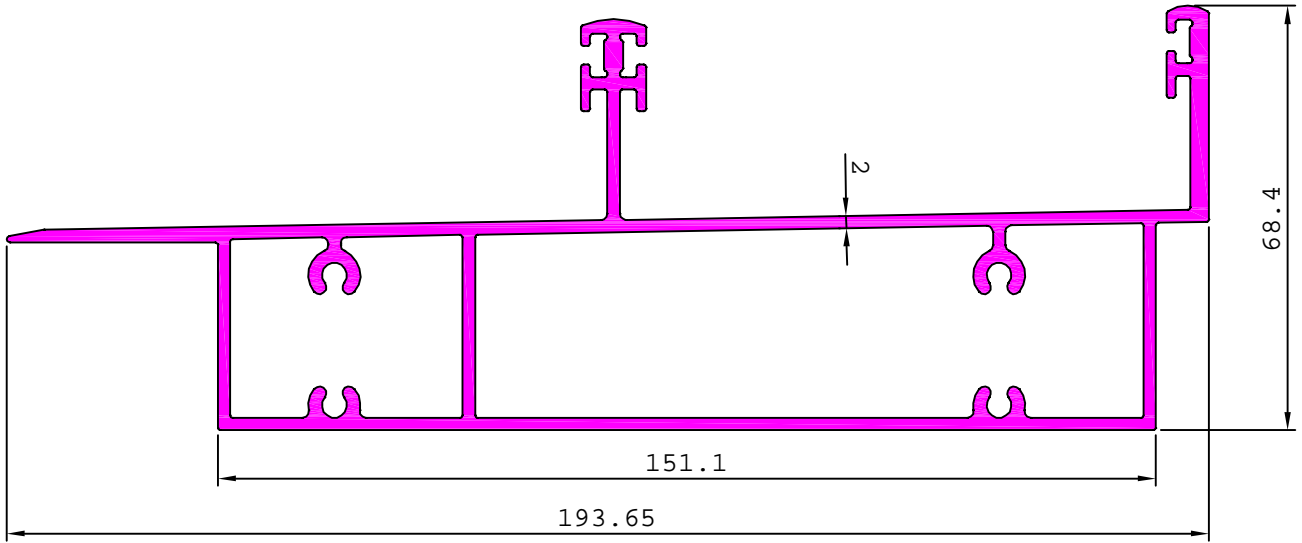

36056

3.299 kg/m

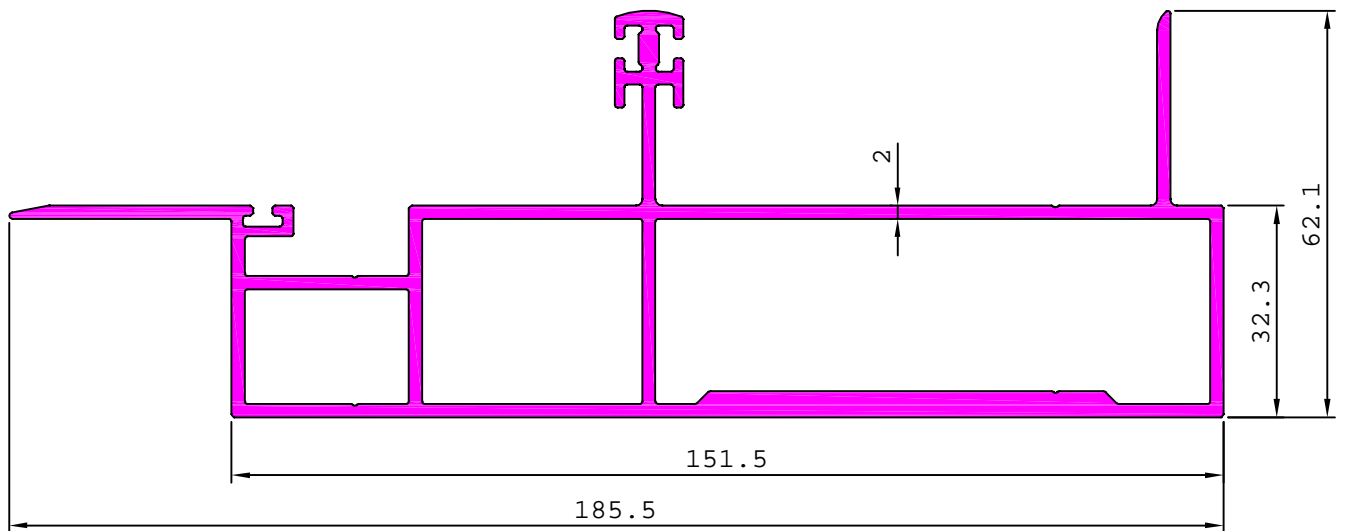

S5812

3.055 kg/m

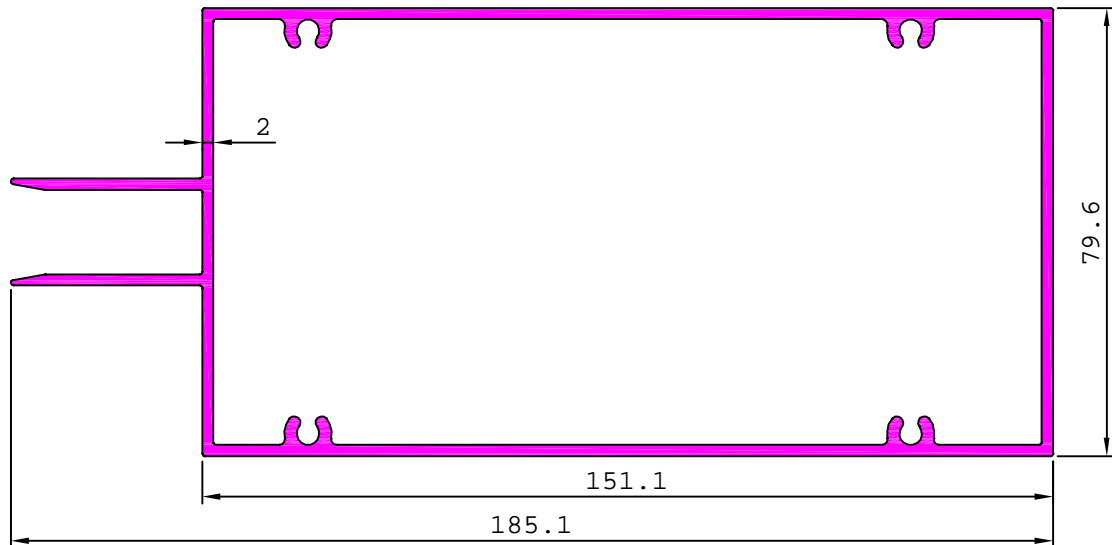

### CURTAIN WALL SECTION-G

36218

1.144 kg/m

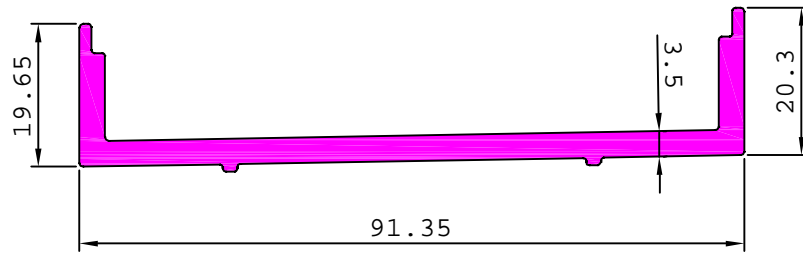

36057

2.909 kg/m

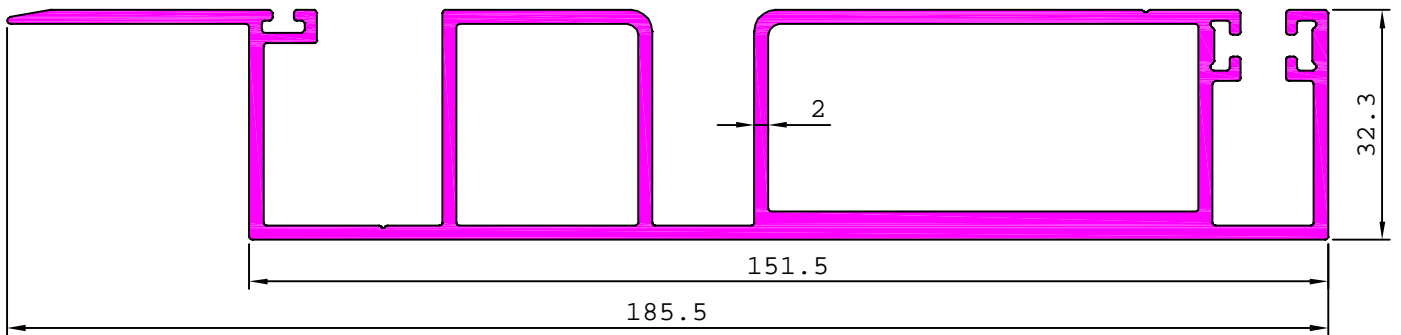

S5815

2.604 kg/m

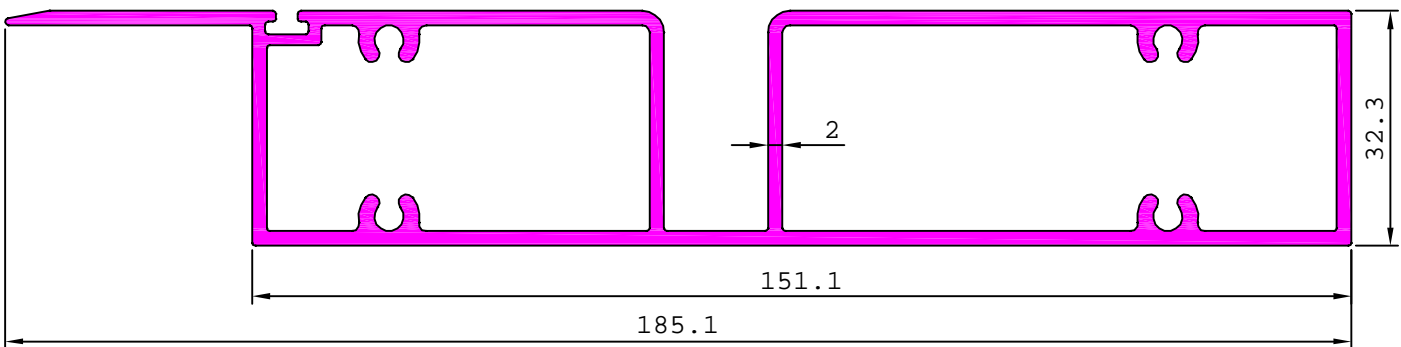

## CURTAIN WALL SECTION-H

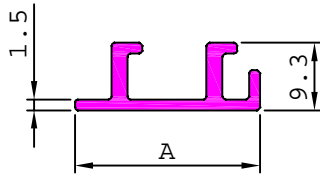

SL. No.	Section No.	A	Weight kg/m
1	<b>S5847</b>	25.45	0.228
2	<b>S5851</b>	30.00	0.246

S5835

1.255 kg/m

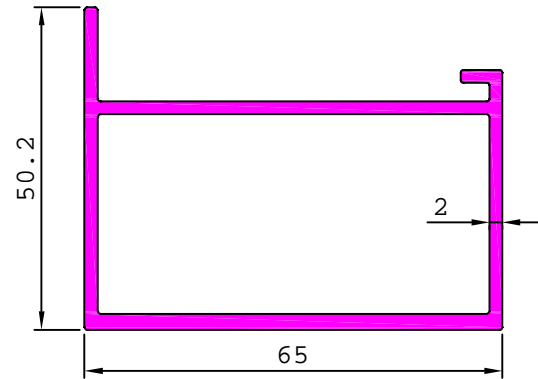

S5837

0.322 kg/m

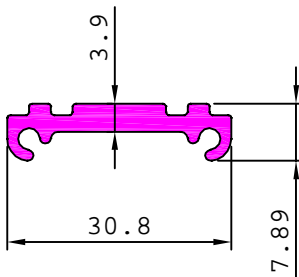

S5845

0.418 kg/m

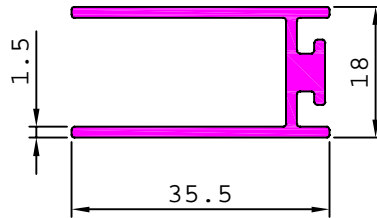

S5852

0.470 kg/m

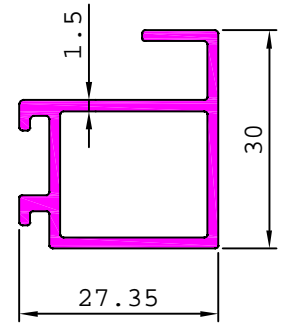

S5861

0.517 kg/m

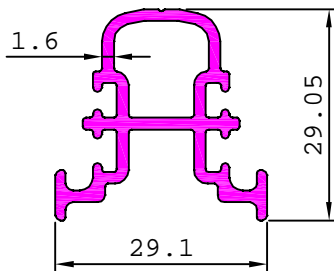

S5865

0.563 kg/m

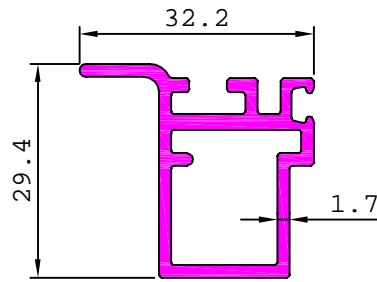

S5866

0.299 kg/m

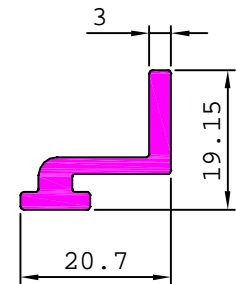

**MATCHING WITH S5866**

**MATCHING WITH S5865**

S5854

1.561 kg/m

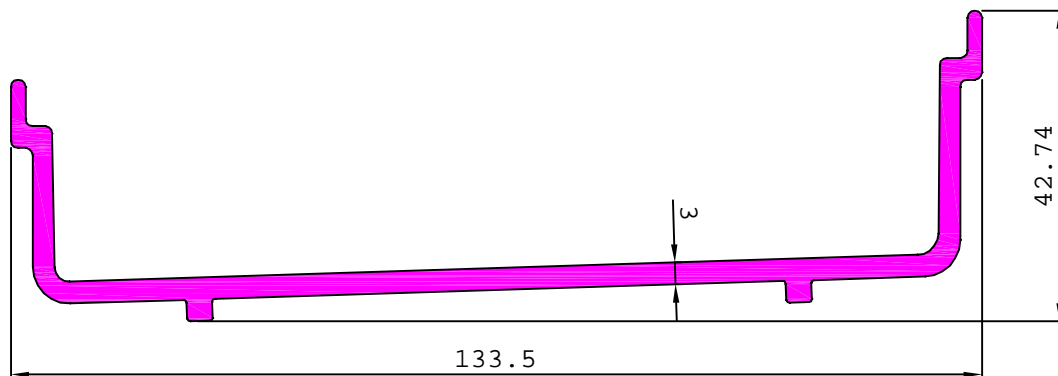

# CURTAIN WALL SECTION-H

S5846

3.030 kg/m

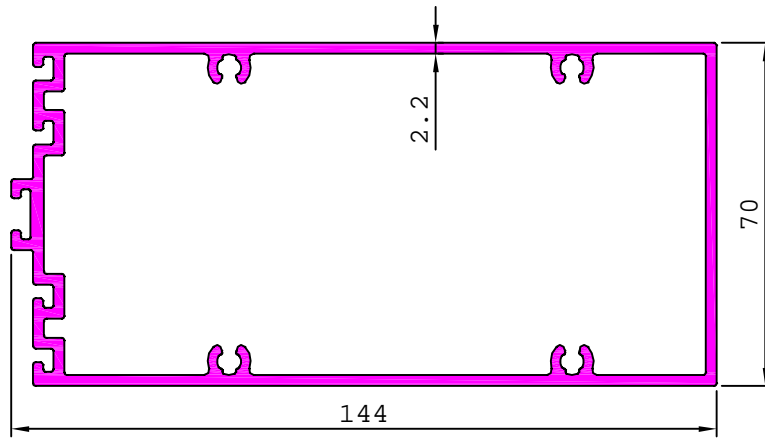

S5848

3.288 kg/m

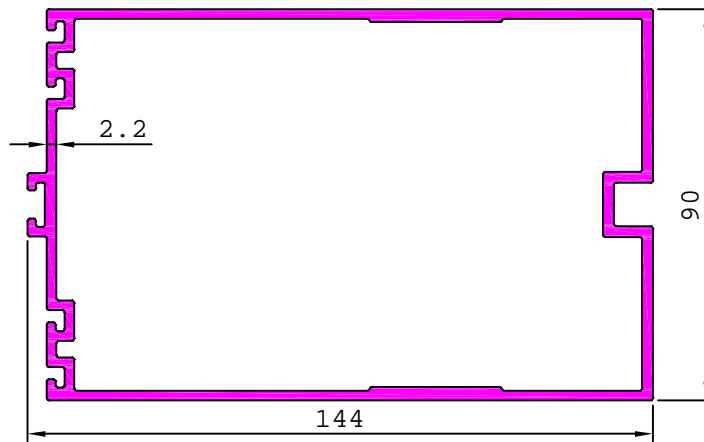

S5855

2.809 kg/m

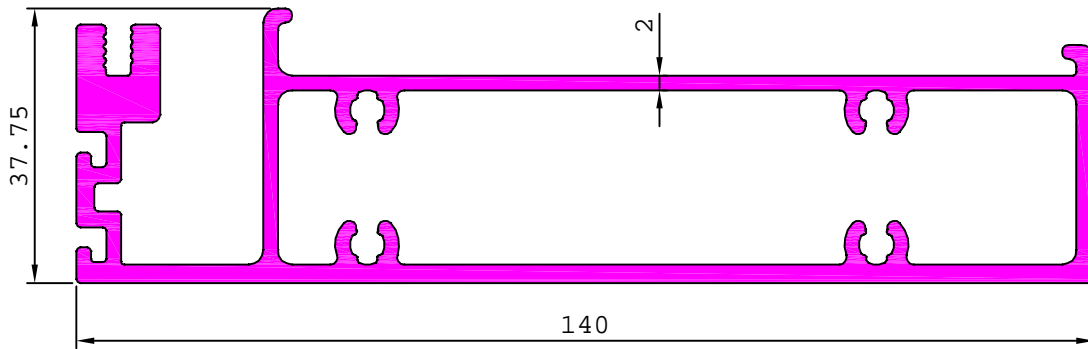

S5856

2.502 kg/m

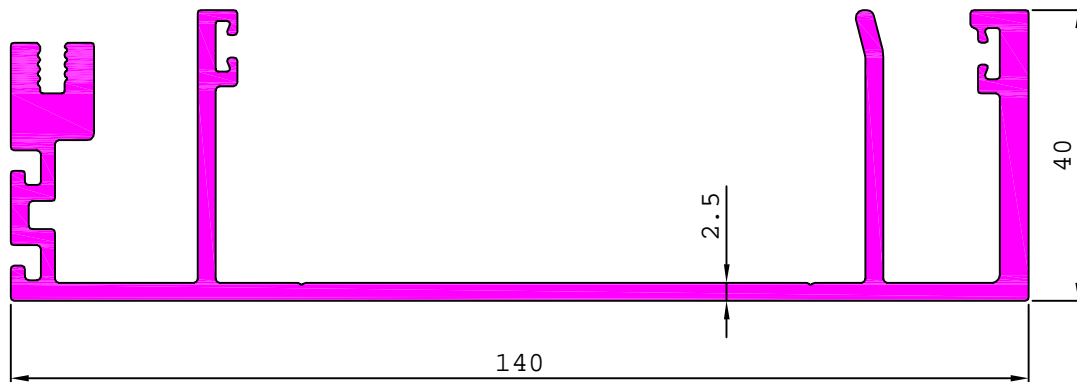

# CURTAIN WALL SECTION-H

S5853

3.834 kg/m

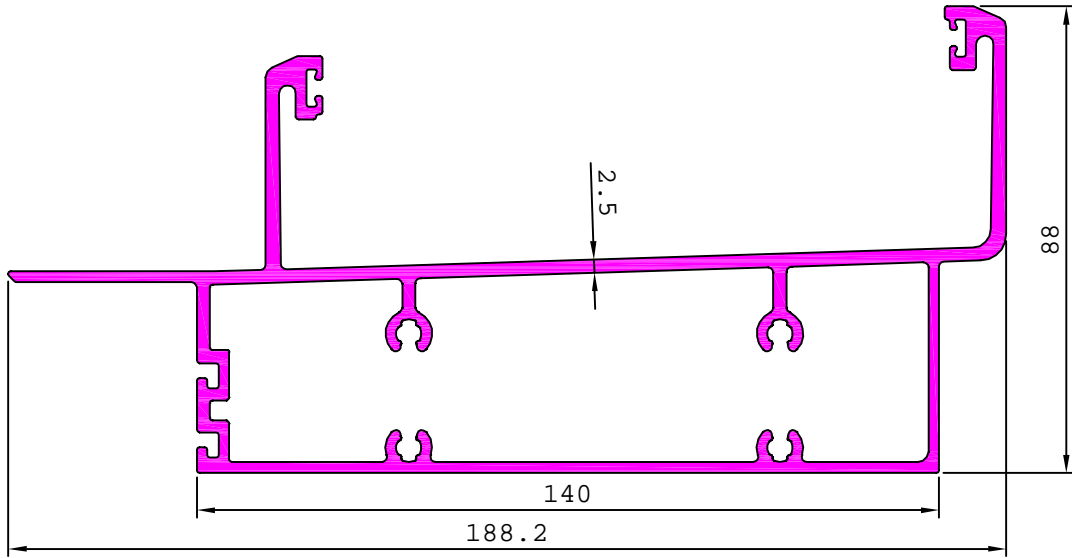

S5857

2.935 kg/m

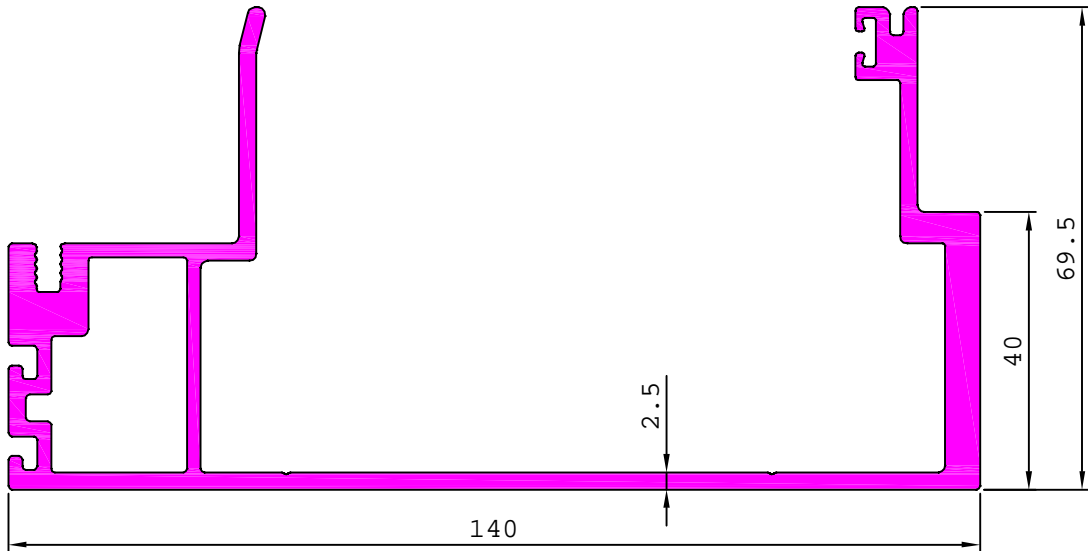

S5860

3.557 kg/m

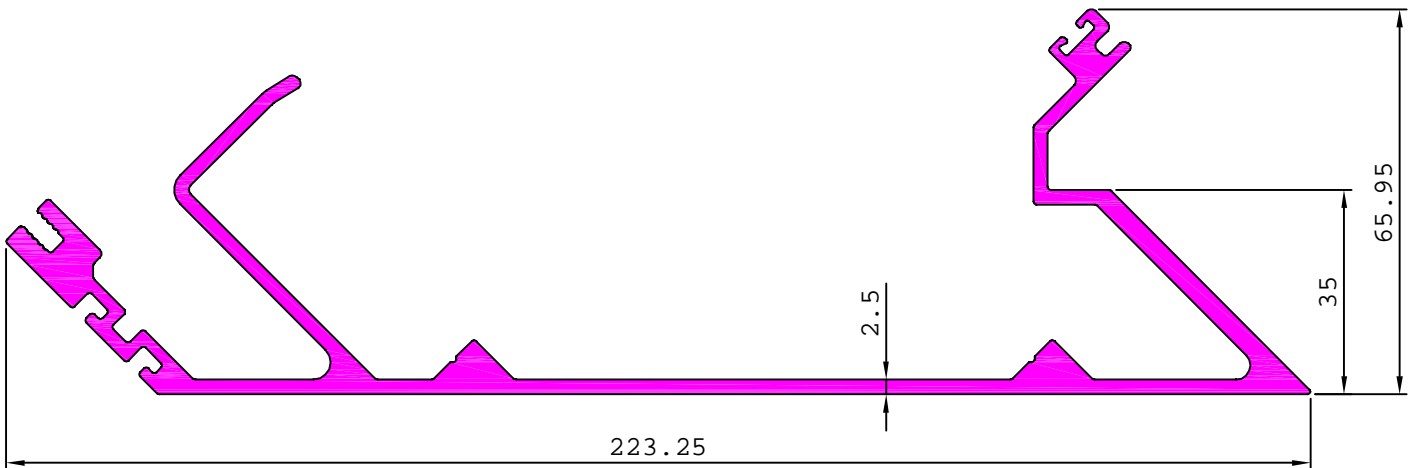

# CURTAIN WALL SECTION-H

S5859

3.171 kg/m

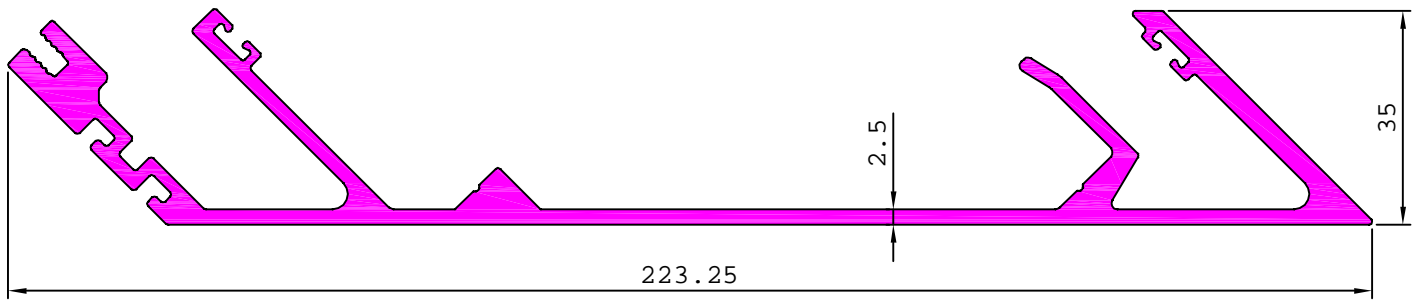

## CURTAIN WALL SECTION-I

36084

0.437 kg/m

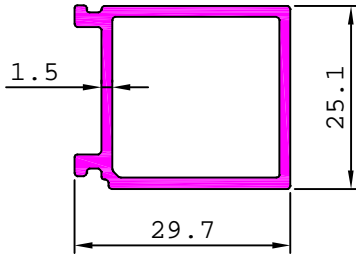

36090

0.558 kg/m

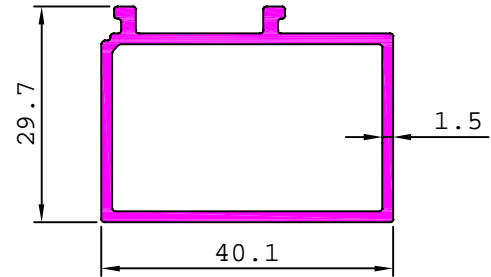

36083

0.529 kg/m

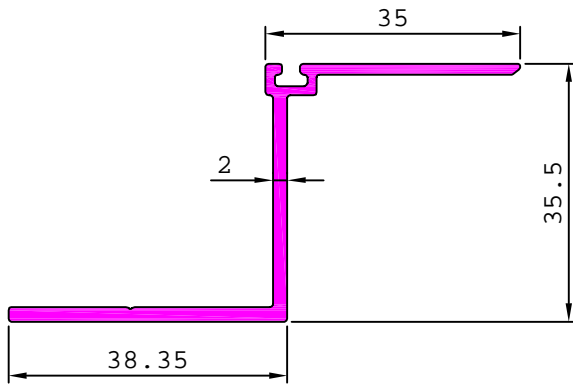

36085

1.062 kg/m

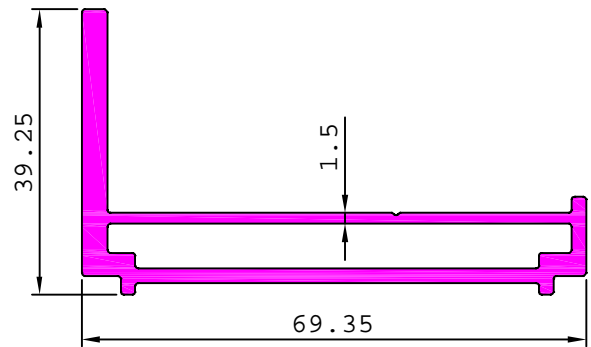

36086

1.591 kg/m

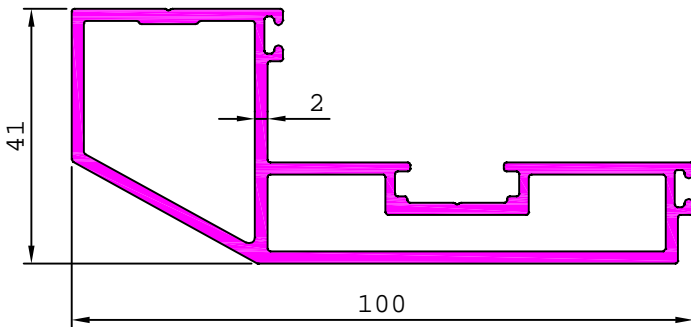

36087

1.183 kg/m

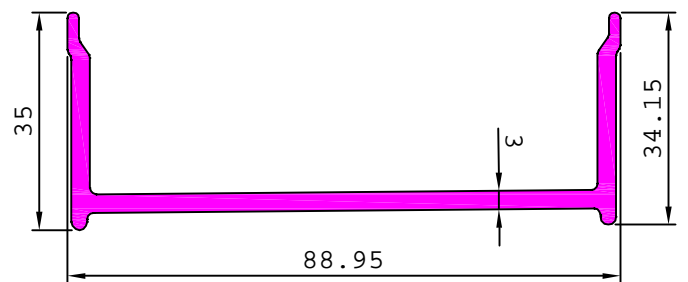

36089

3.286 kg/m

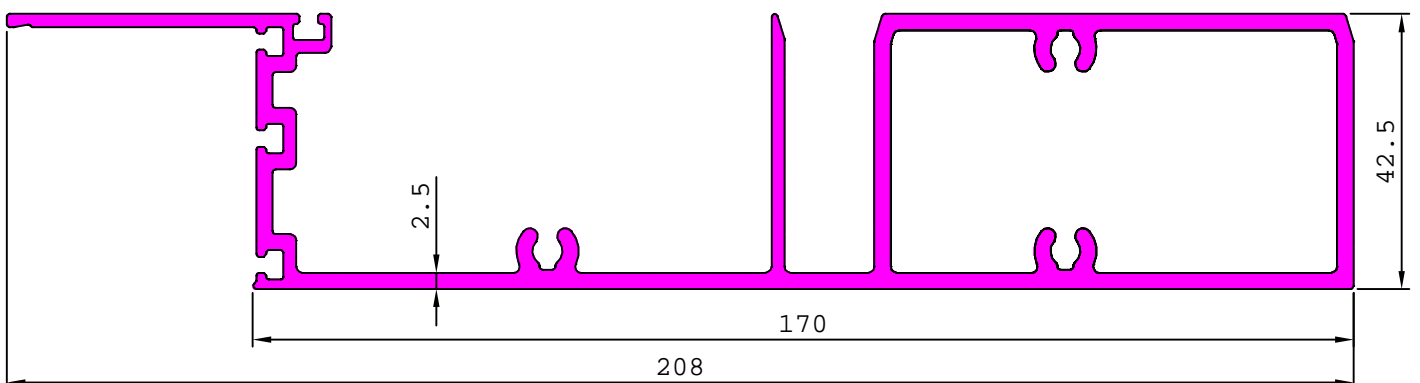

## CURTAIN WALL SECTION-I

36088

4.177 kg/m

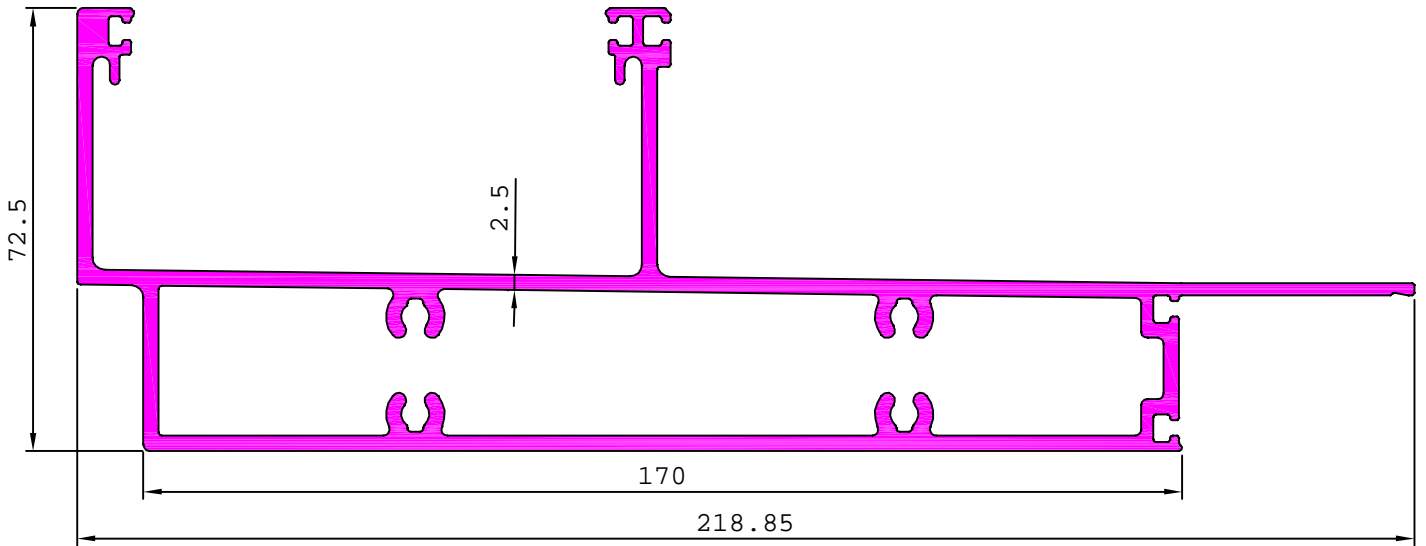

36091

4.164 kg/m

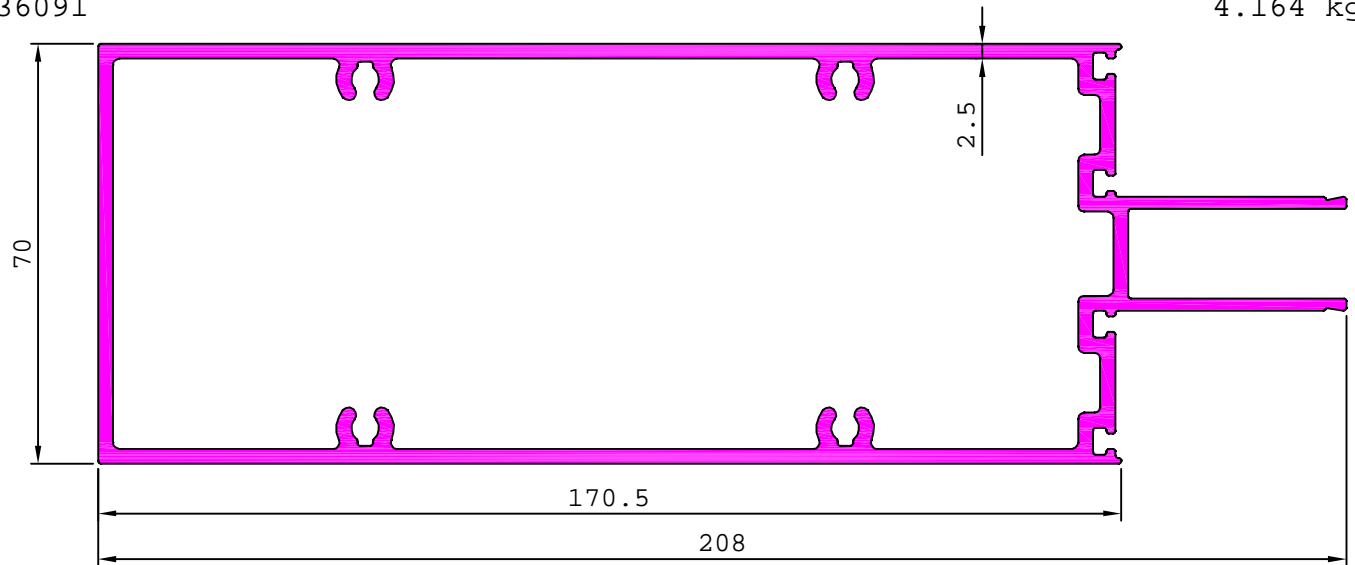

36092

3.000 kg/m

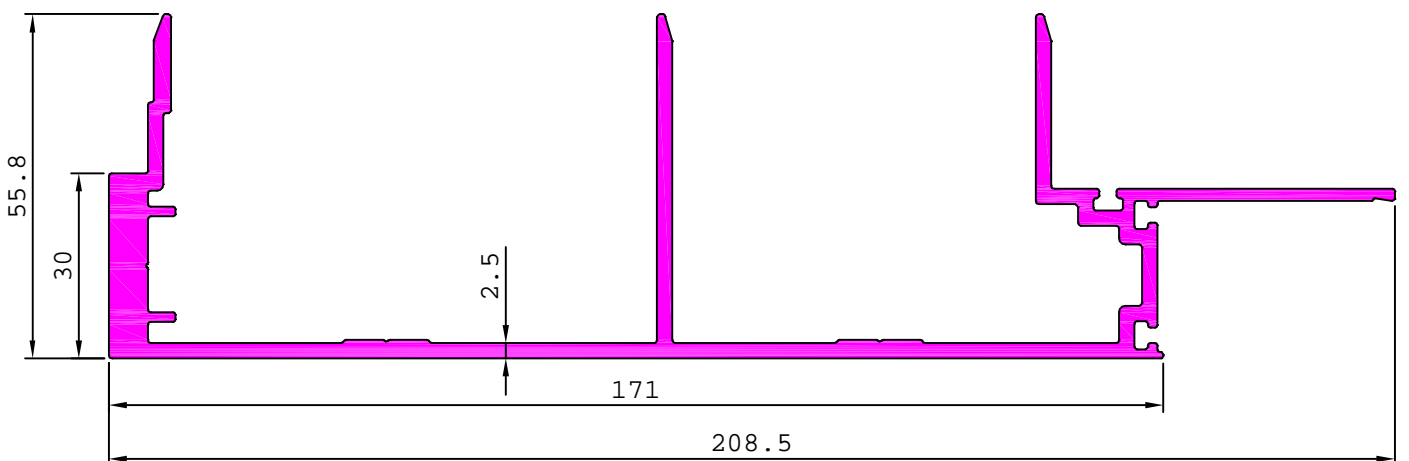

### CURTAIN WALL SECTION-I

36093

2.371 kg/m

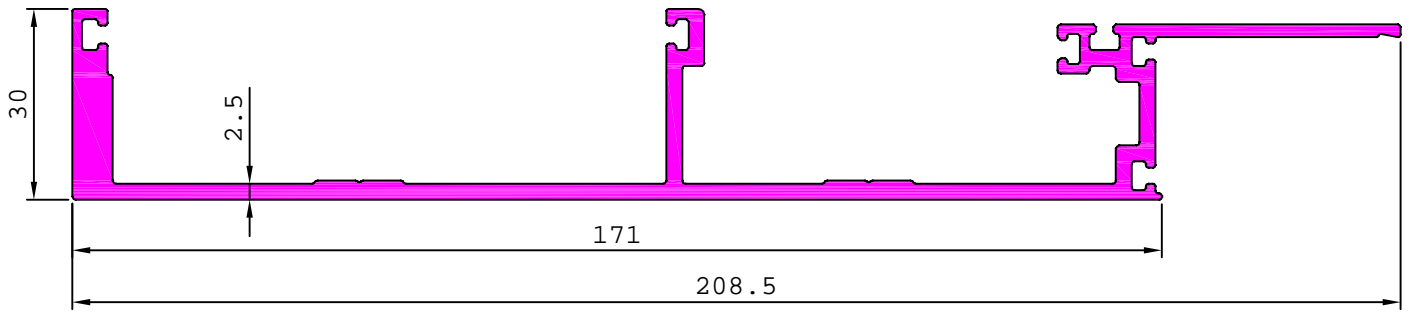

## CURTAIN WALL SECTION-J

36095

0.399 kg/m

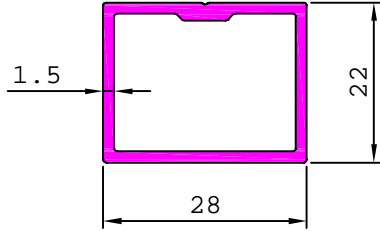

S6138

0.610 kg/m

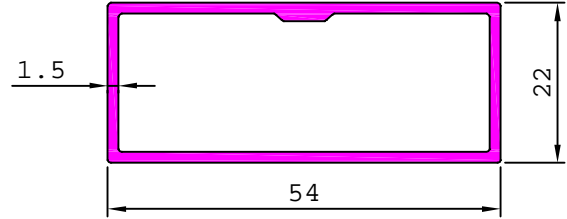

36117

0.526 kg/m

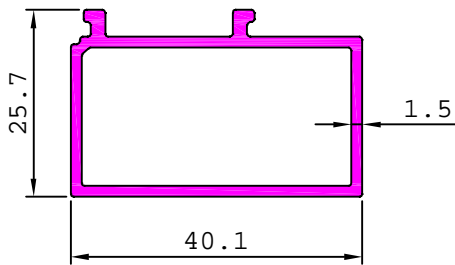

36116

0.404 kg/m

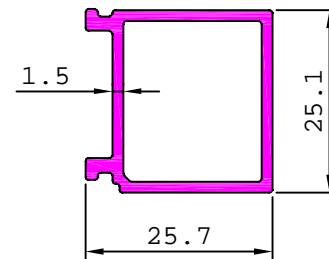

36112

2.338 kg/m

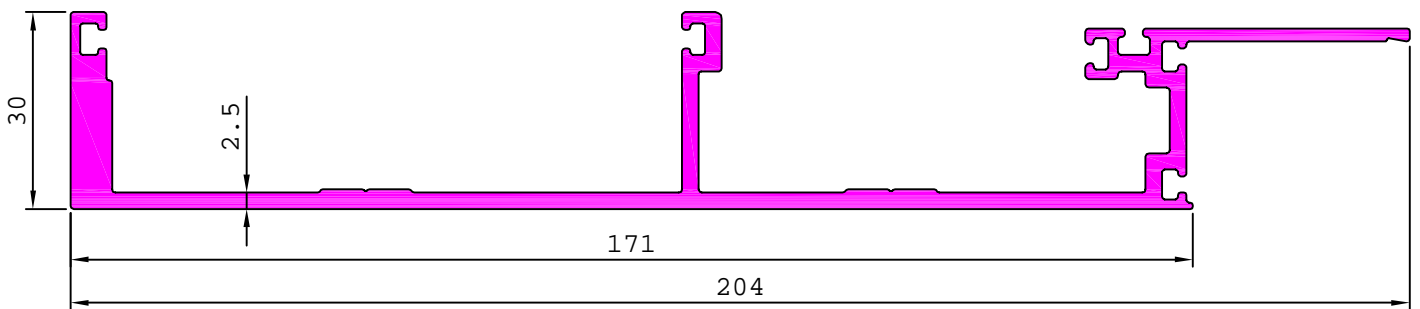

36121

3.090 kg/m

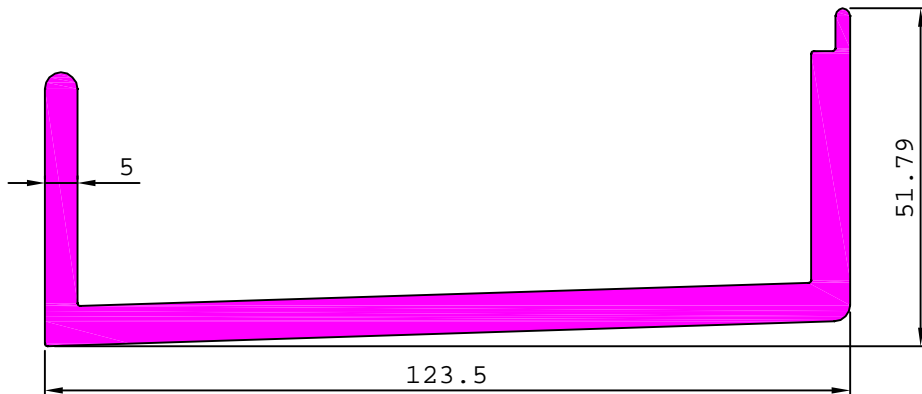

### CURTAIN WALL SECTION-J

36094

2.609 kg/m

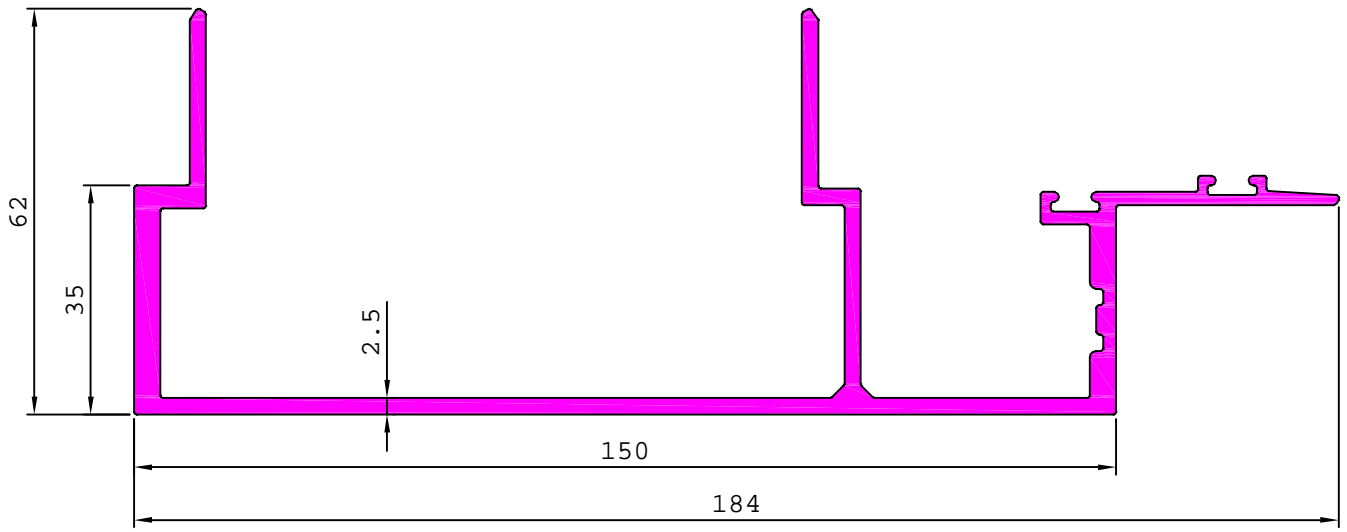

36096

2.322 kg/m

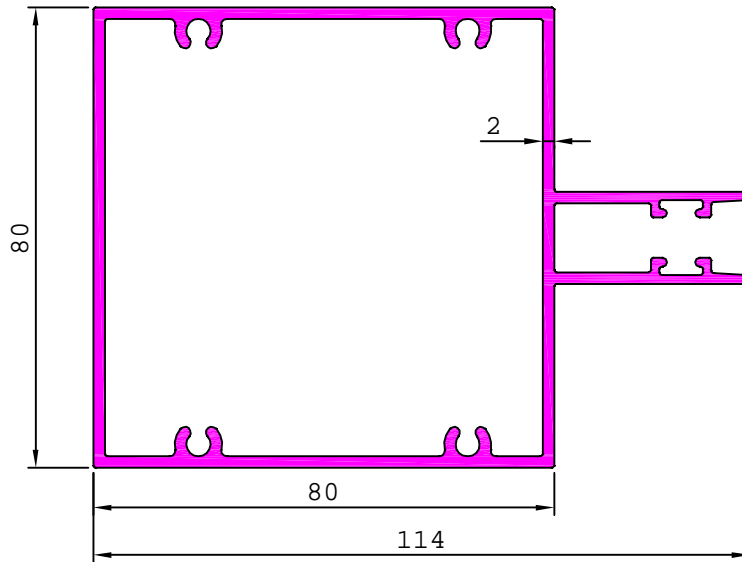

36111

4.110 kg/m

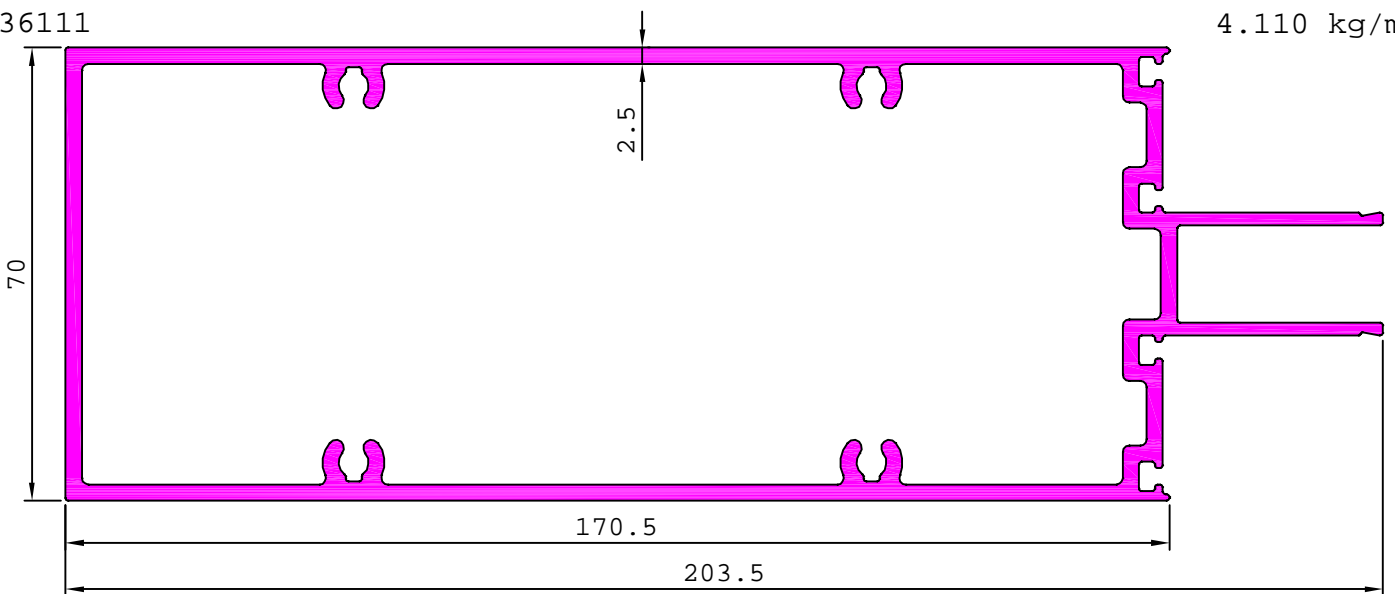

### CURTAIN WALL SECTION-J

36115

2.964 kg/m

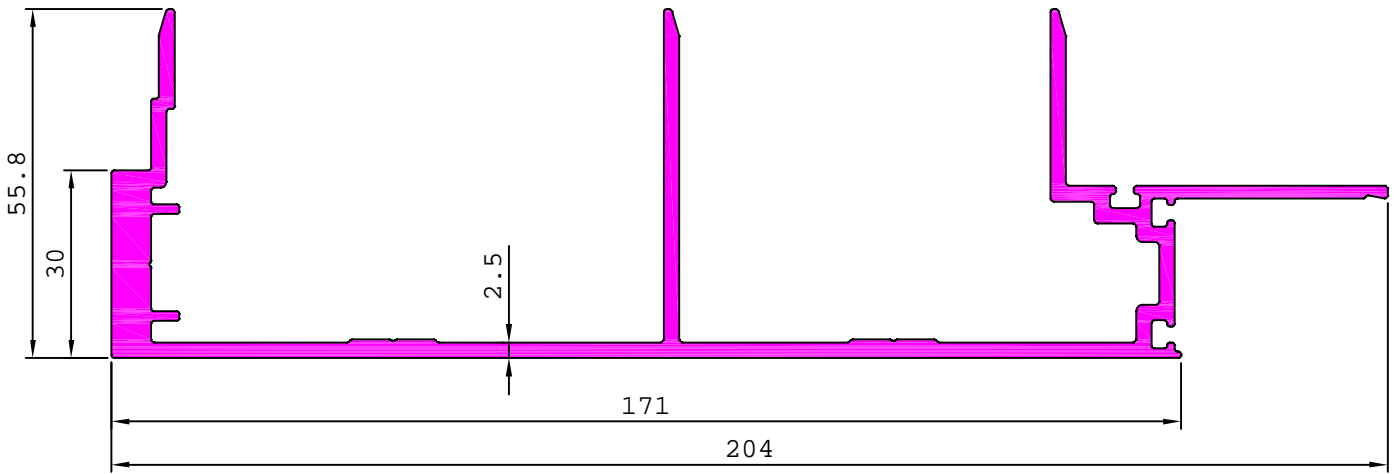

36097

3.449 kg/m

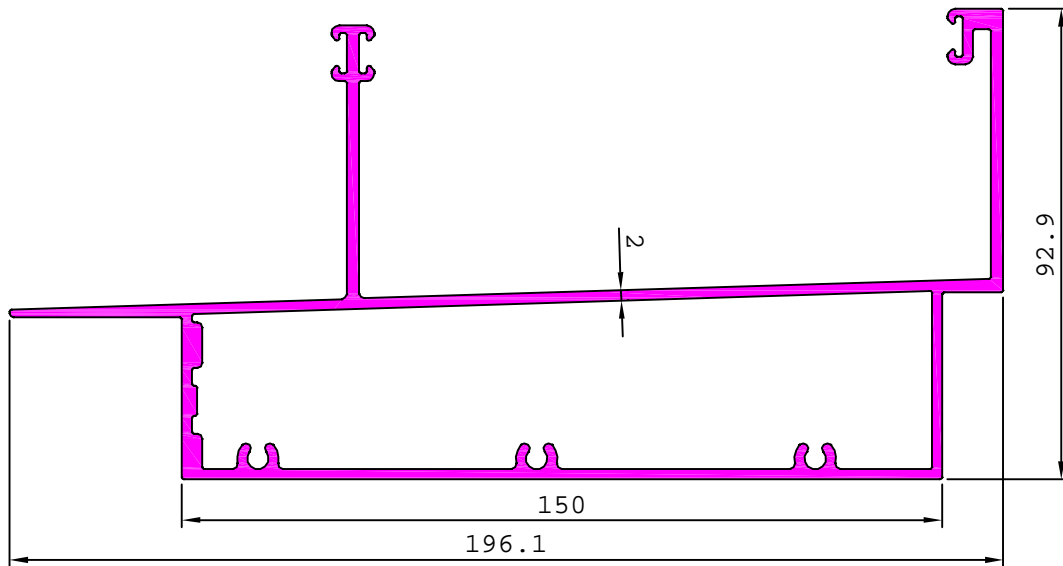

36113

4.146 kg/m

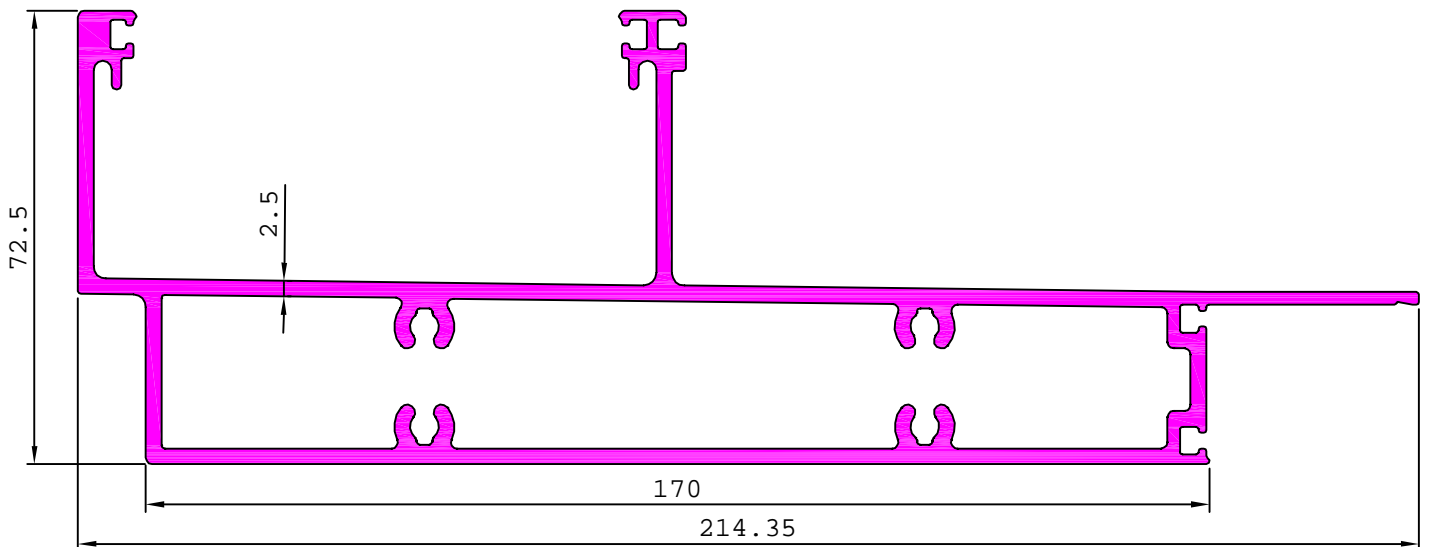

## CURTAIN WALL SECTION-J

36098

2.773 kg/m

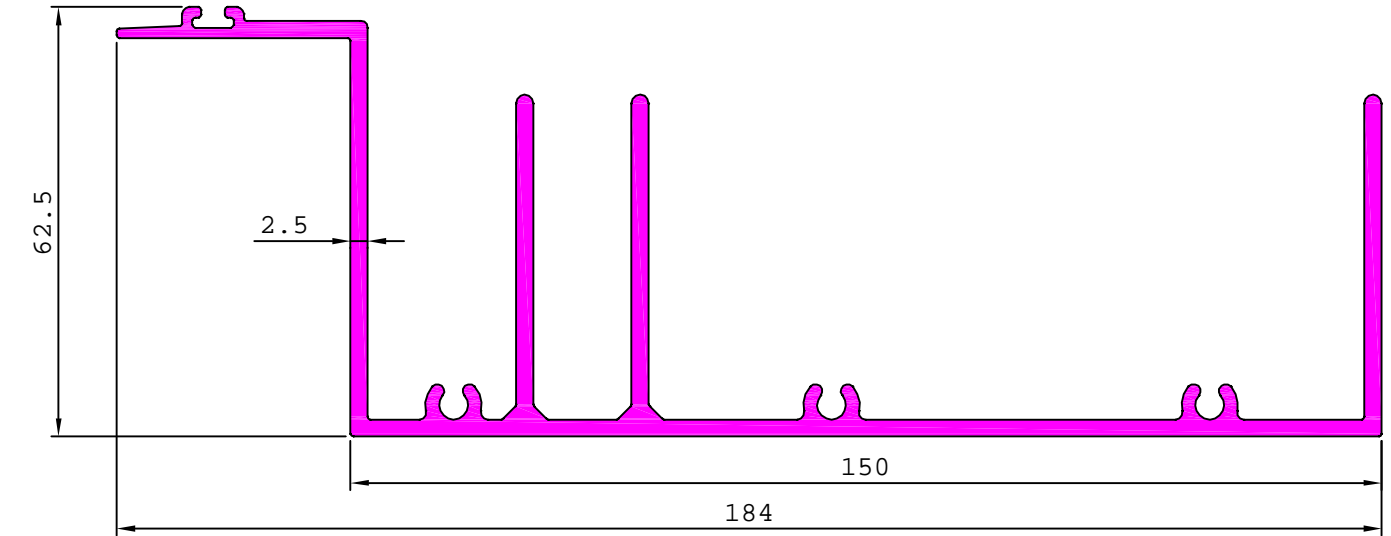

36099

2.986 kg/m

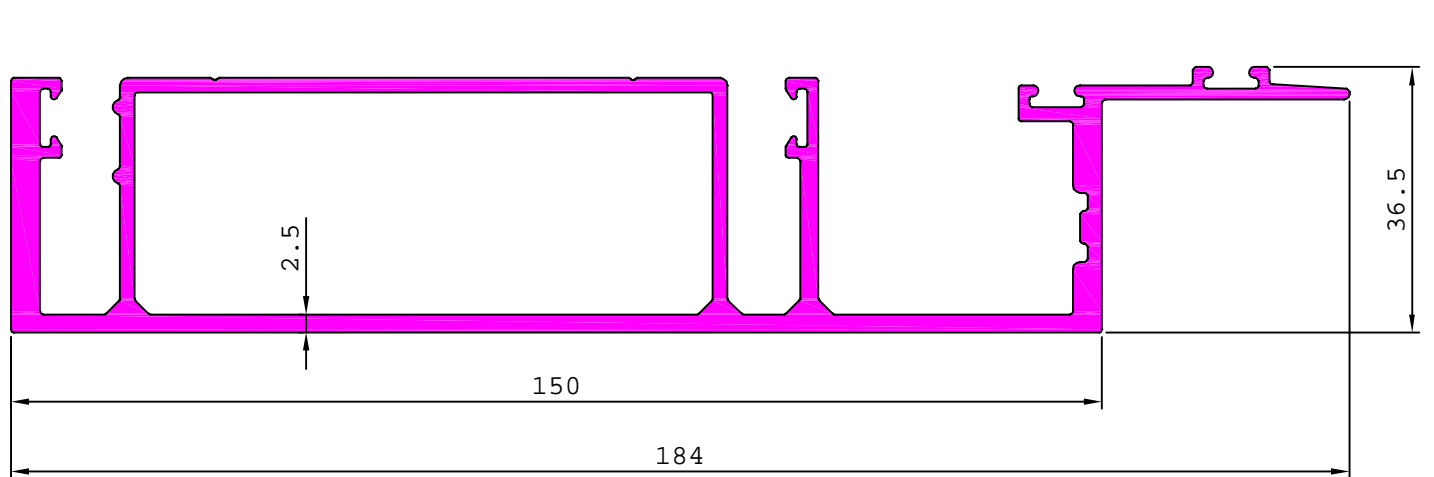

36114

3.256 kg/m

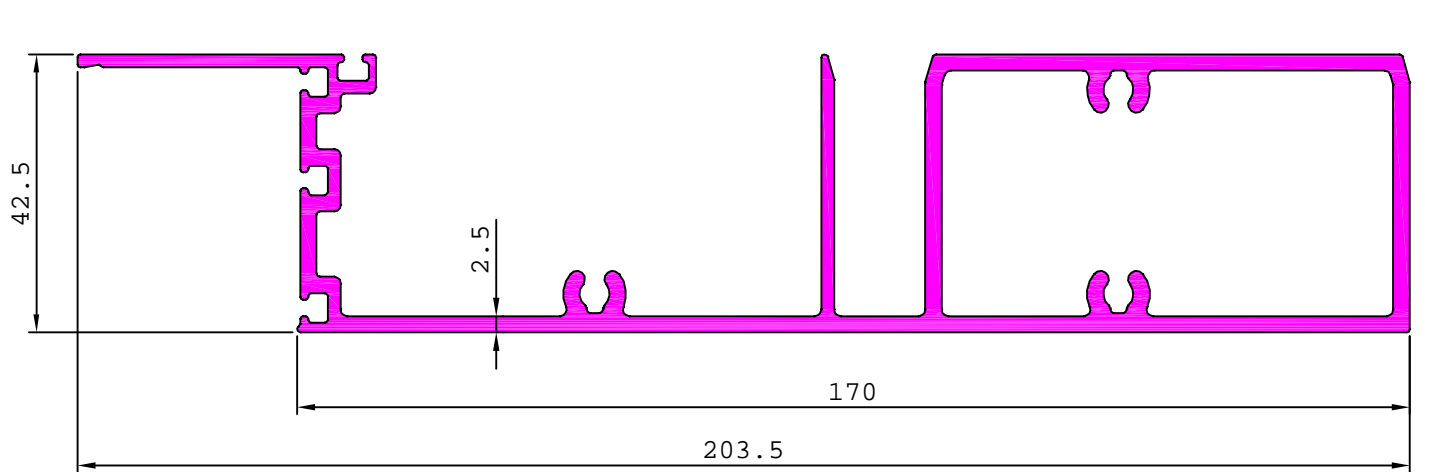

## CURTAIN WALL SECTION-K

36127

4.127 kg/m

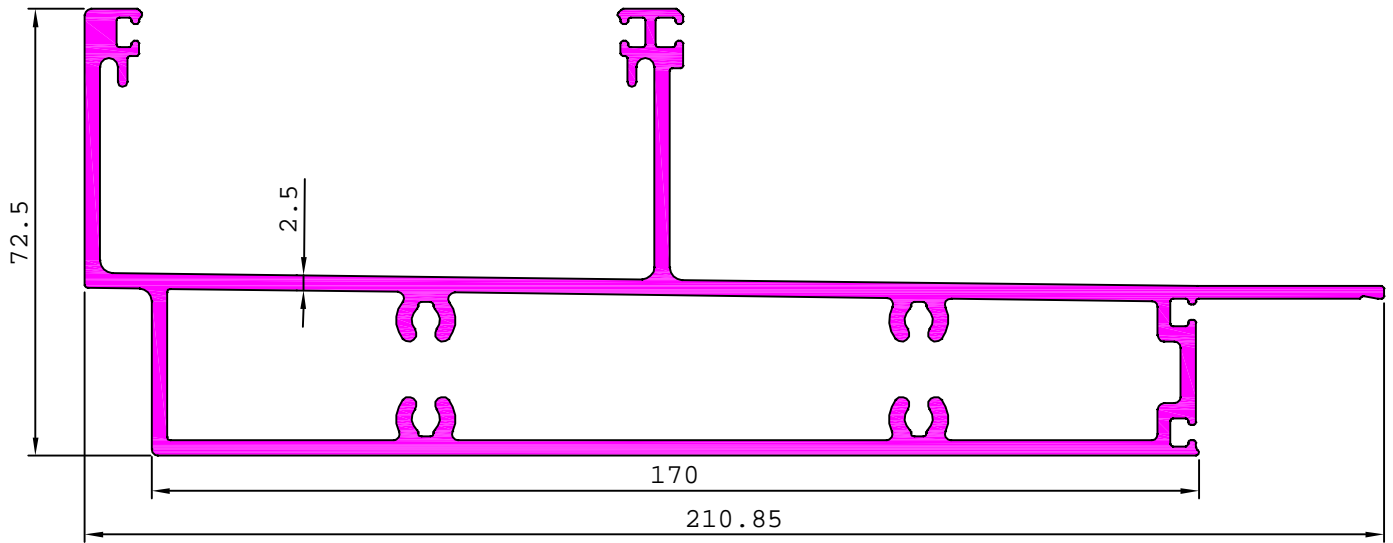

36128

3.252 kg/m

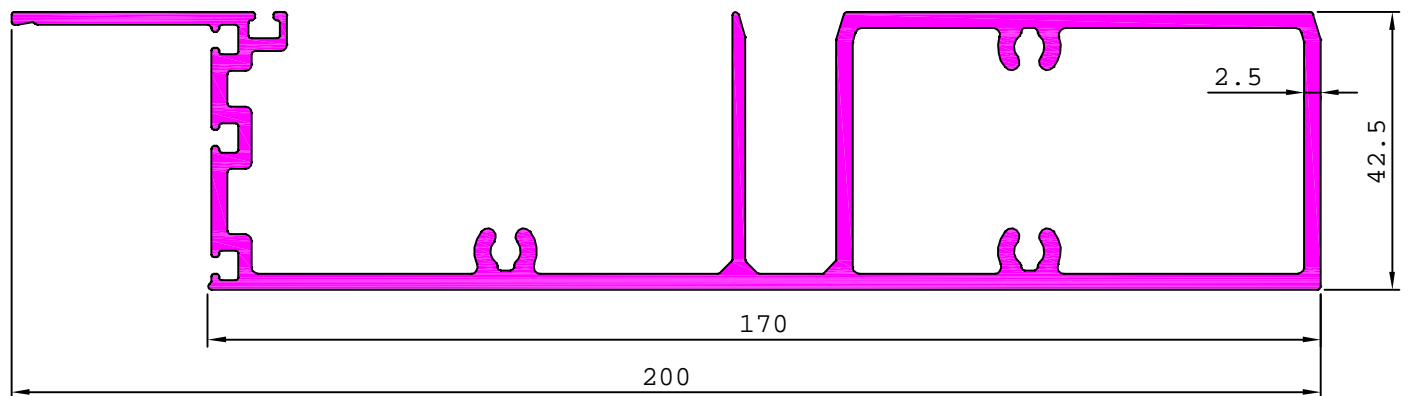

36129

2.939 kg/m

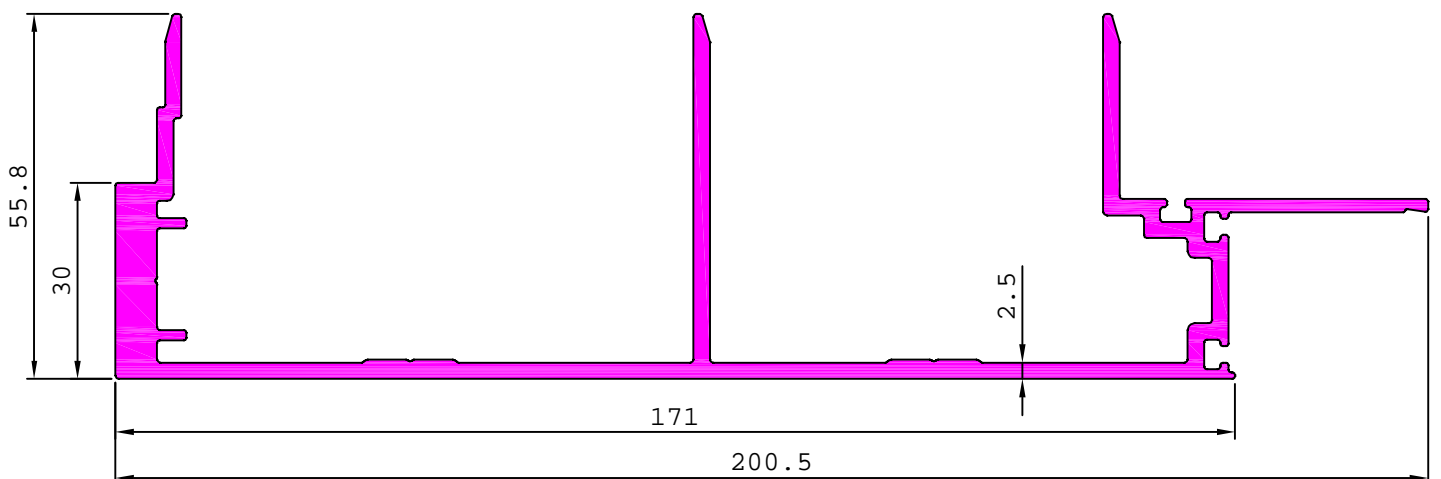

### CURTAIN WALL SECTION-K

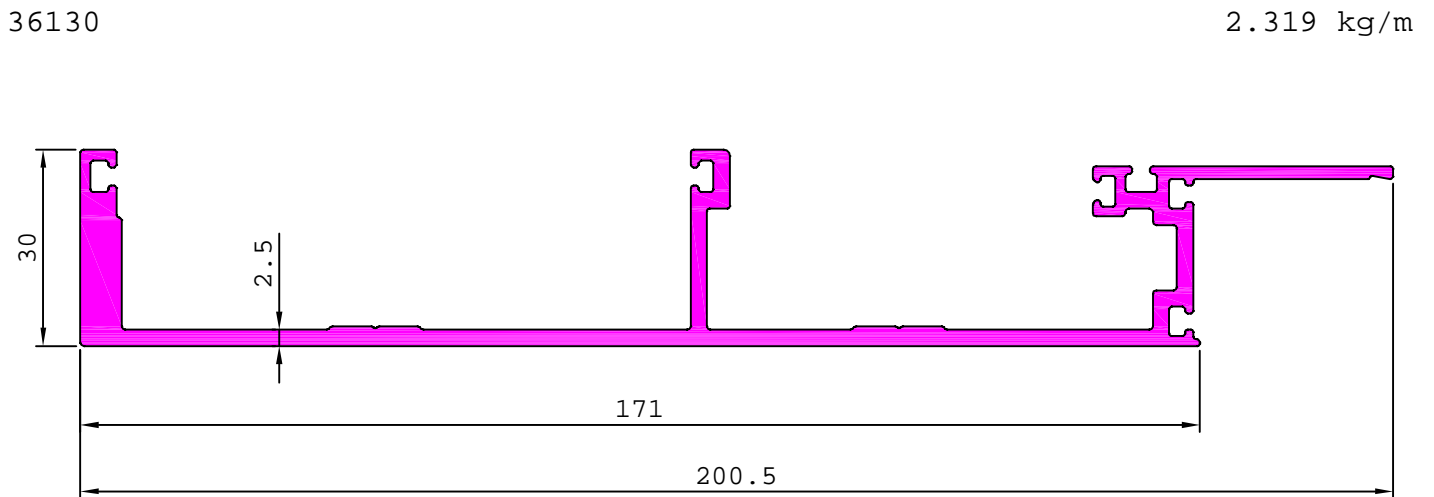
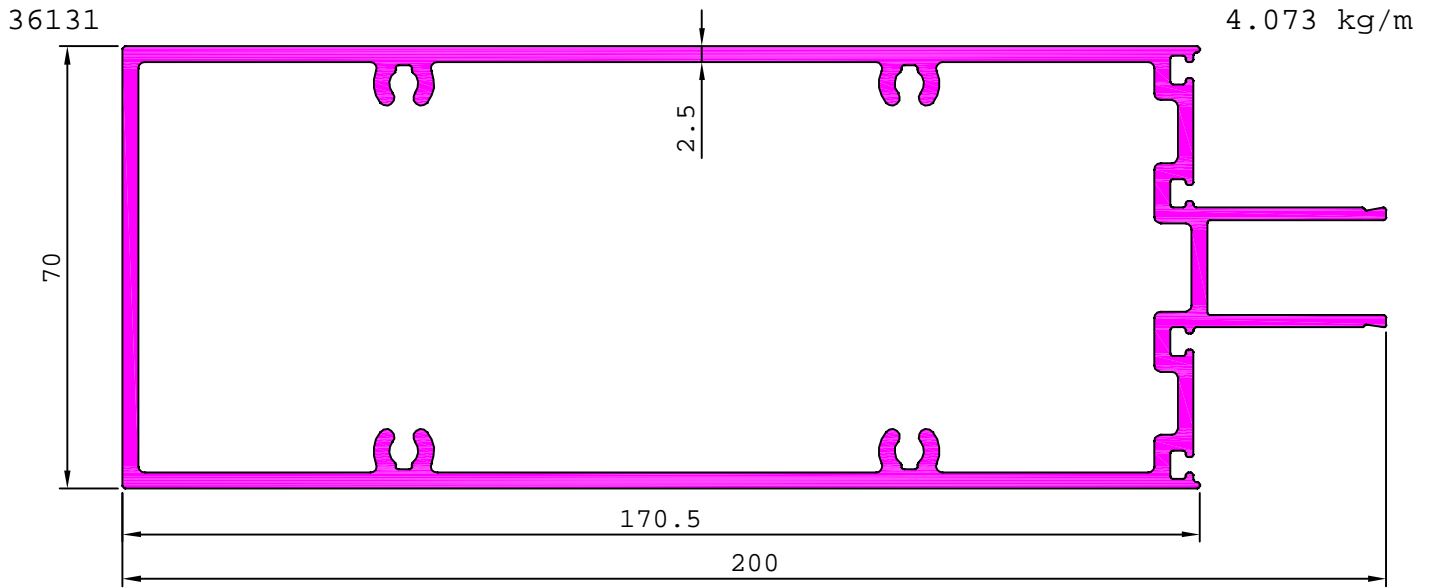

## CURTAIN WALL SECTION-L

S6262

1.196 kg/m

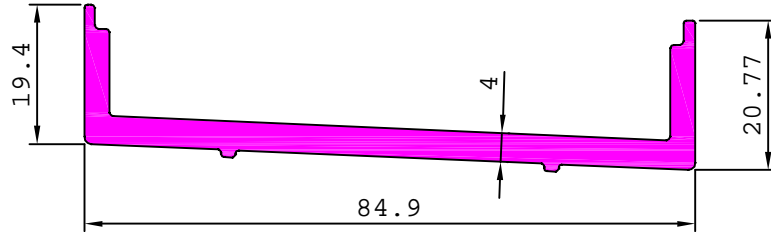

S6257

2.676 kg/m

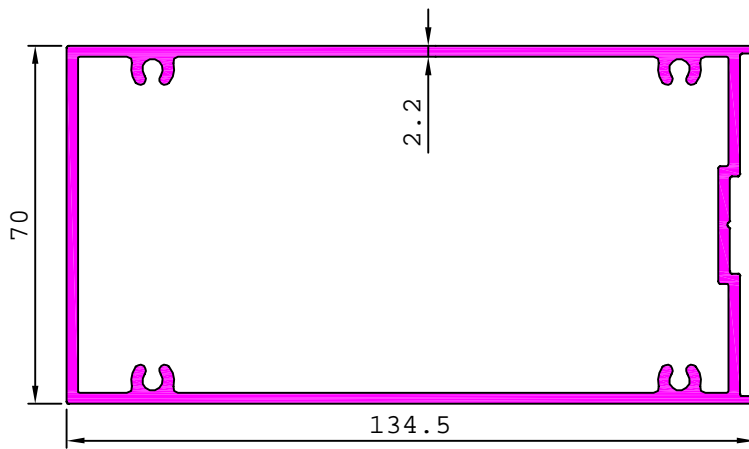

S6256

1.932 kg/m

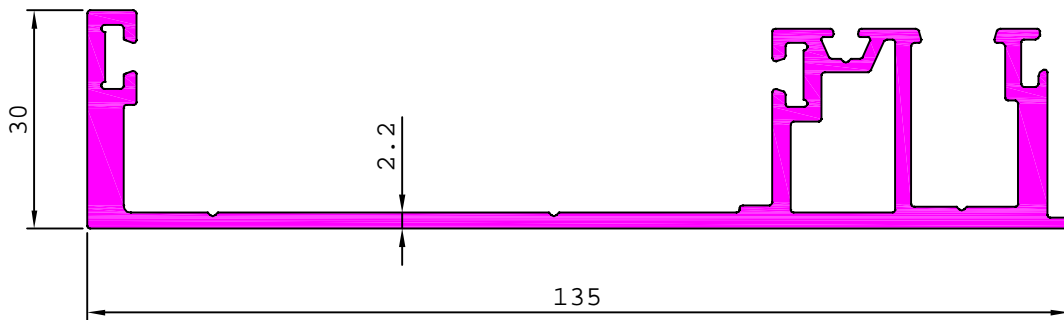

S6258

2.425 kg/m

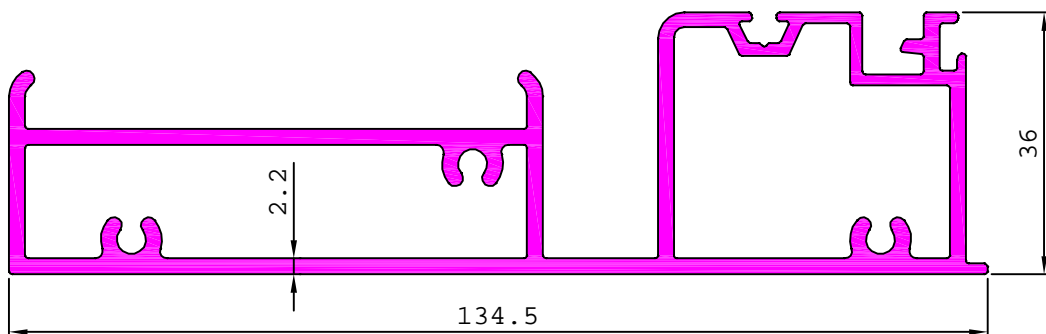

## CURTAIN WALL SECTION-L

S6259

3.212 kg/m

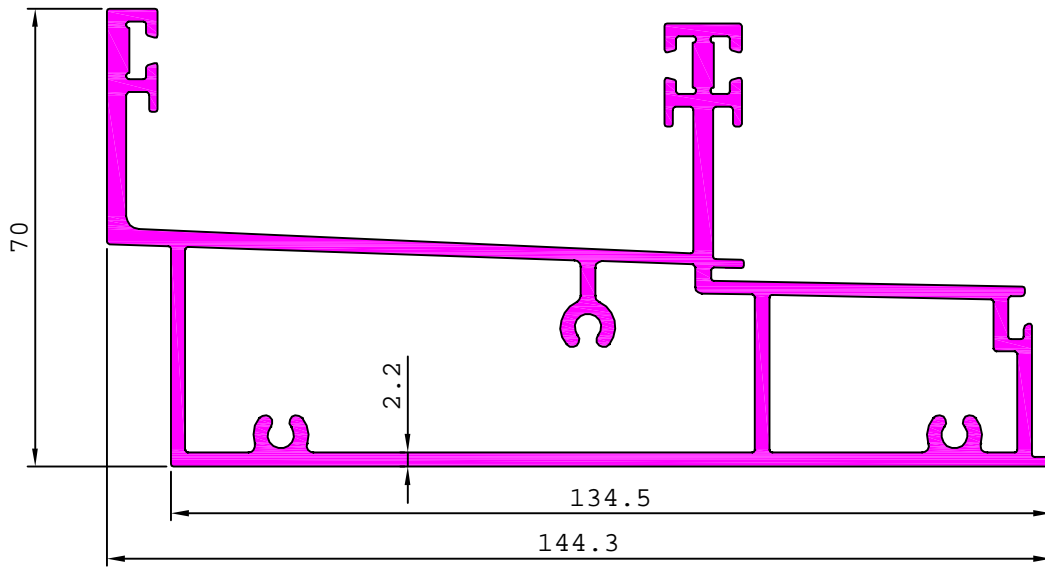

S6260

2.368 kg/m

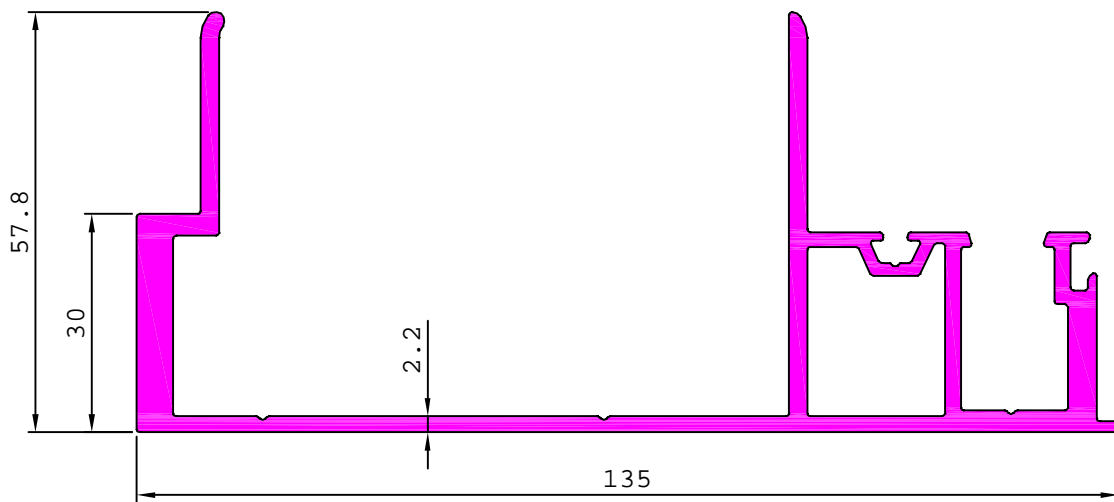

S6261

1.965 kg/m

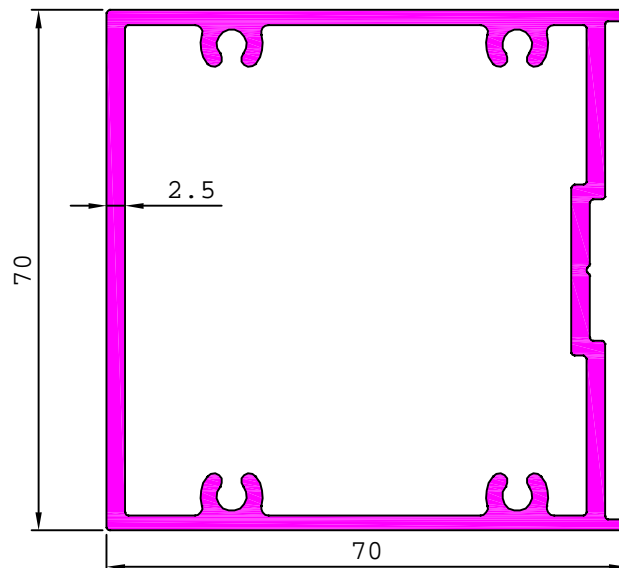

### CURTAIN WALL SECTION-M

35721

3.893 kg/m

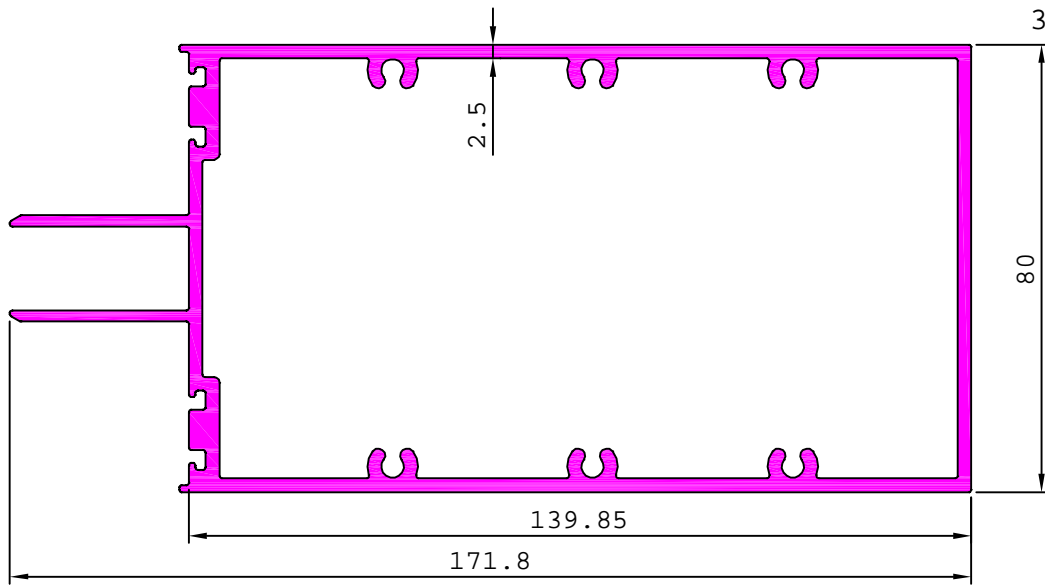

35725

4.370 kg/m

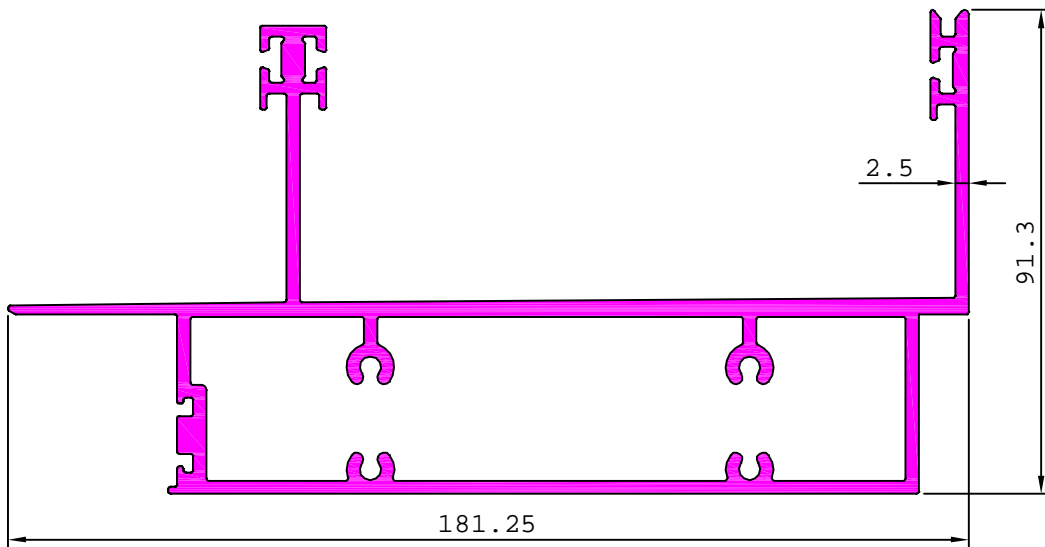

35729

2.760 kg/m

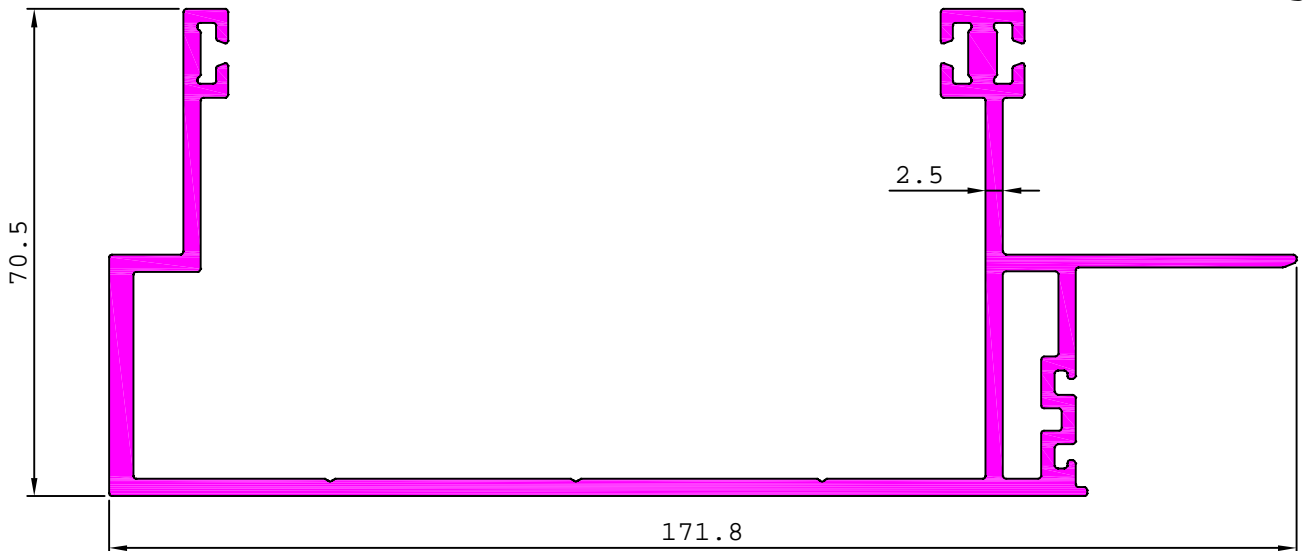

## CURTAIN WALL SECTION-M

35714

1.736 kg/m

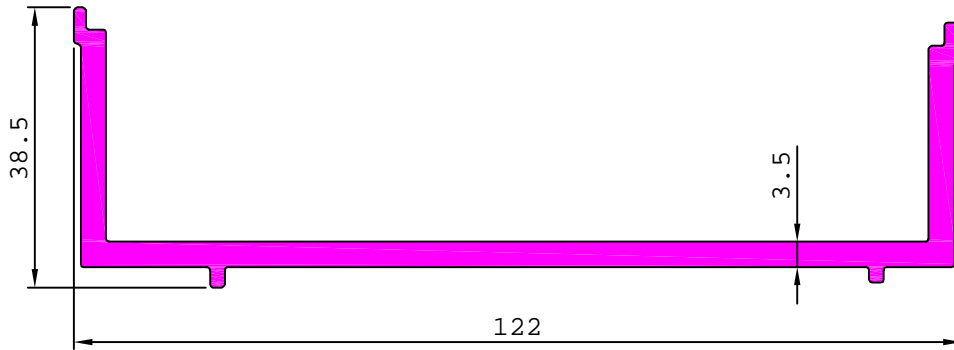

35724

2.409 kg/m

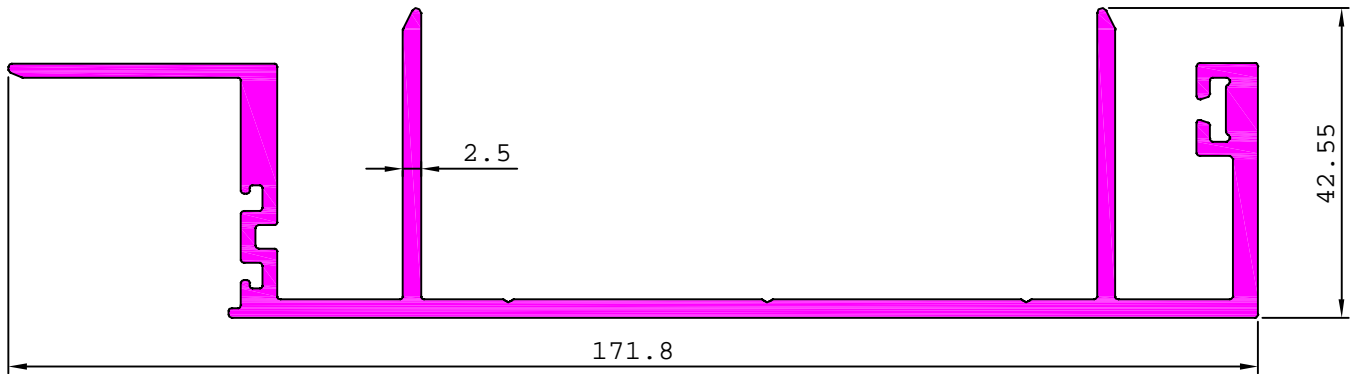

35727

3.600 kg/m

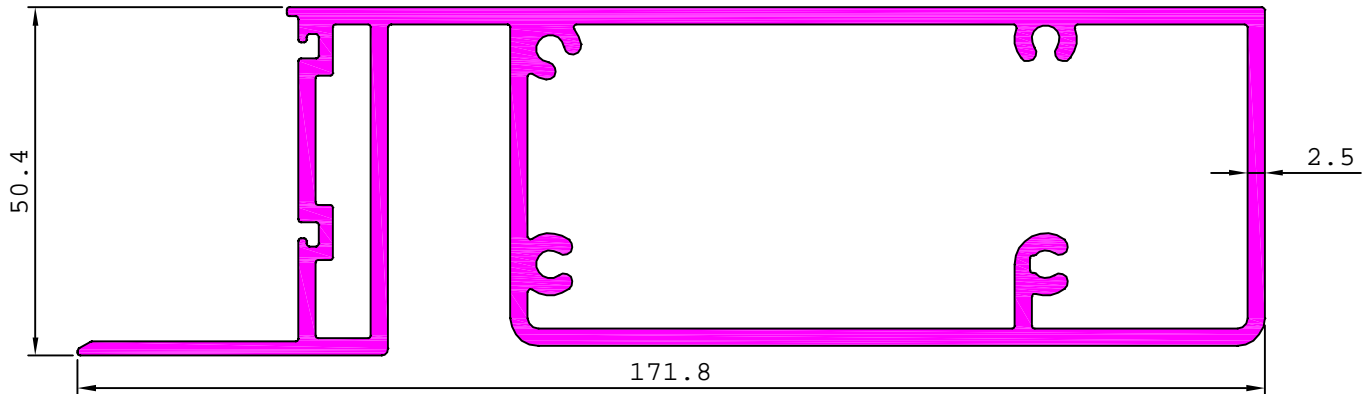

S4646

1.879 kg/m

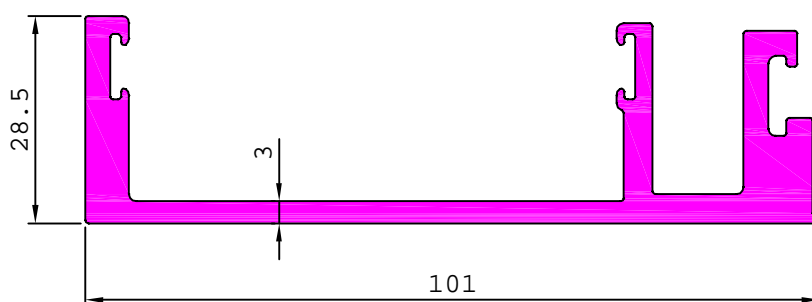

## CURTAIN WALL SECTION-N

S6392

1.576 kg/m

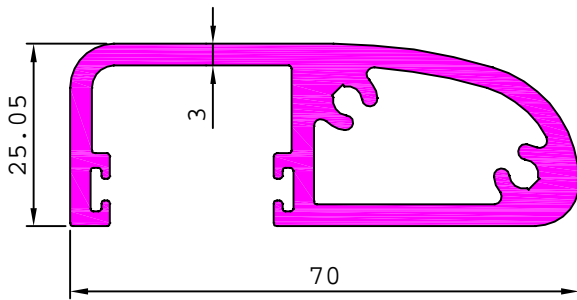

S6393

0.225 kg/m

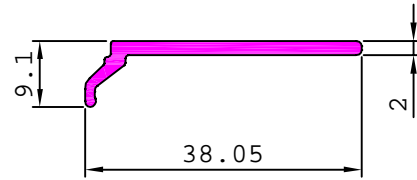

S6399

0.425 kg/m

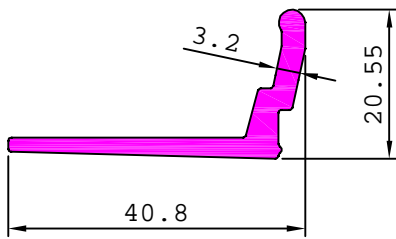

S6404

2.399 kg/m

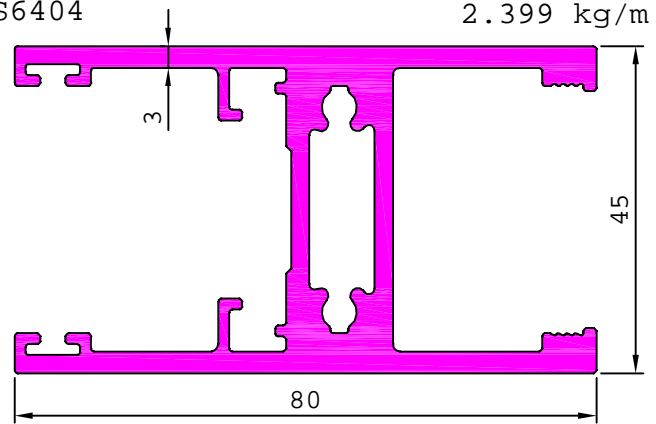

S6391

3.547 kg/m

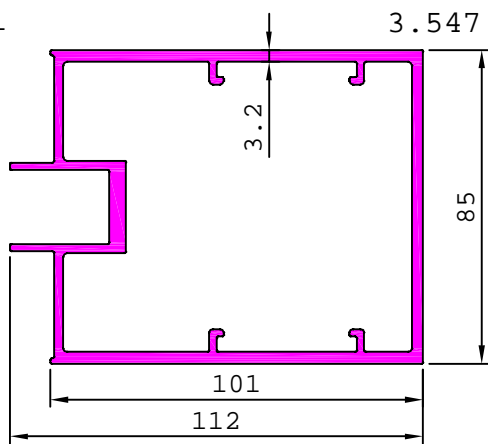

S6405

2.132 kg/m

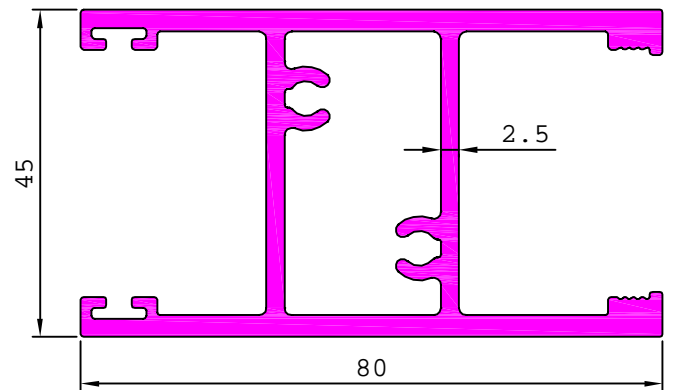

S6389

2.339 kg/m

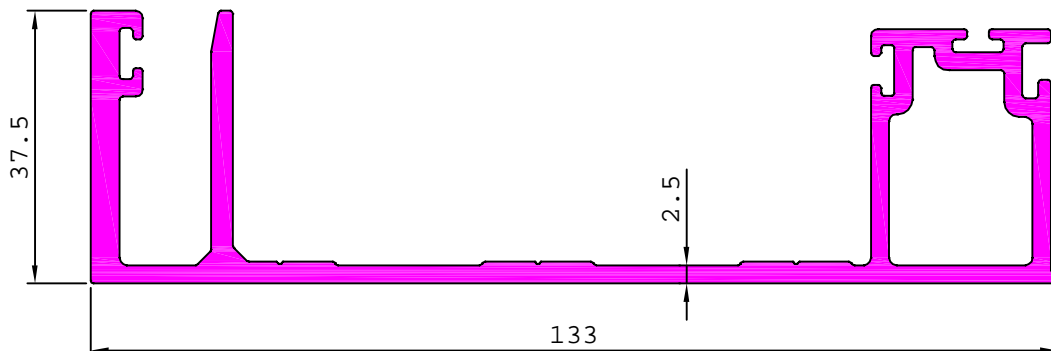

## CURTAIN WALL SECTION-N

S6388

2.790 kg/m

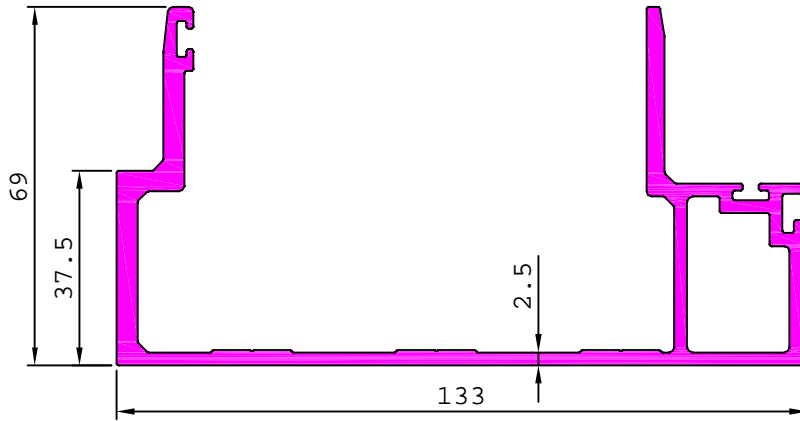

S6398

4.528 kg/m

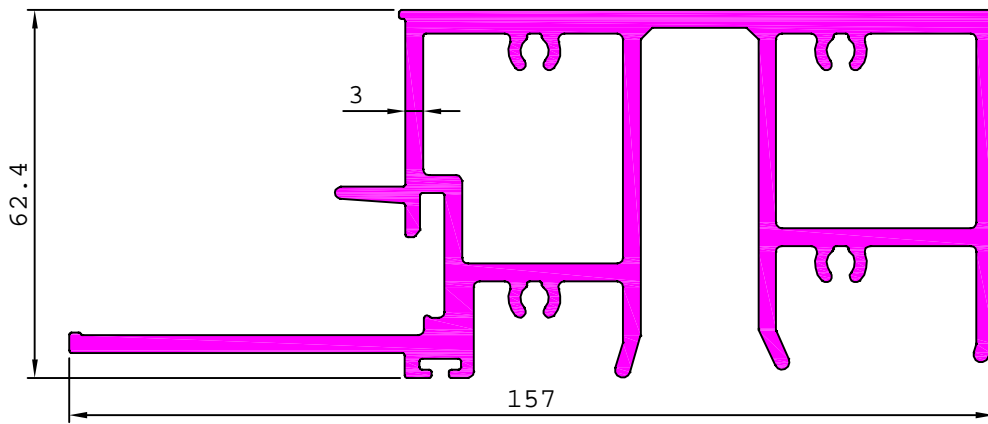

S6390

3.701 kg/m

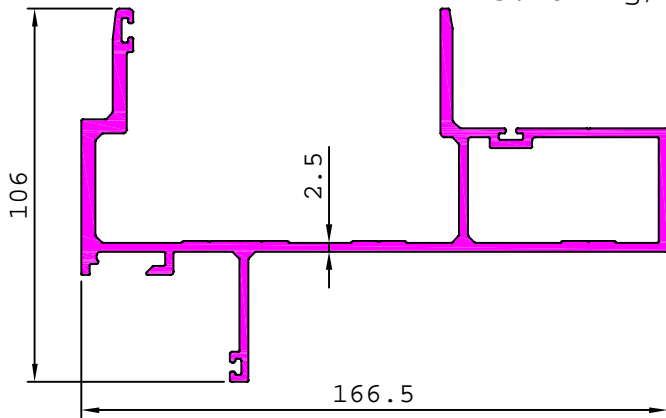

S6394

3.233 kg/m

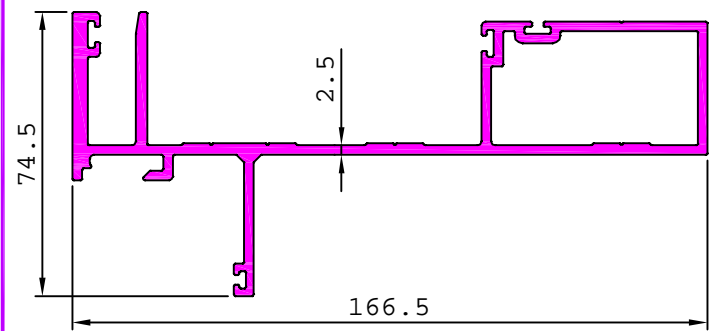

S6400

3.509 kg/m

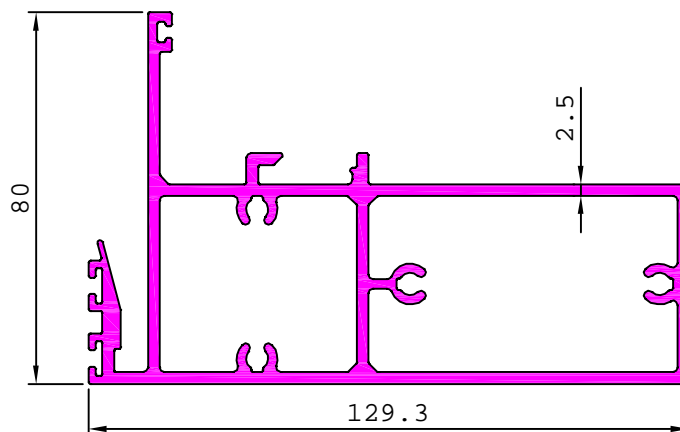

### CURTAIN WALL SECTION-N

S6395

10.507 kg/m

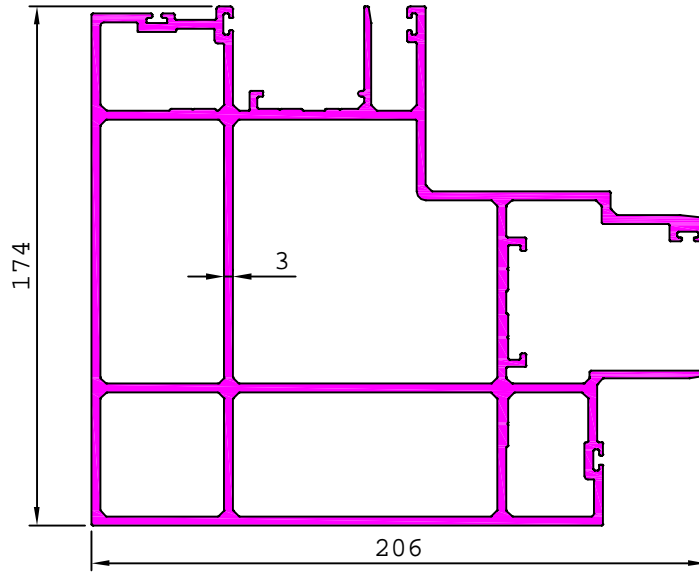

S6396

11.259 kg/m

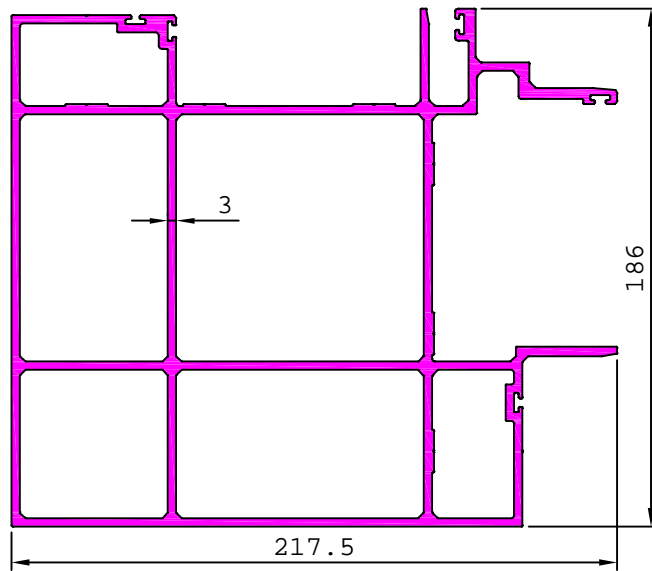

S6397

5.815 kg/m

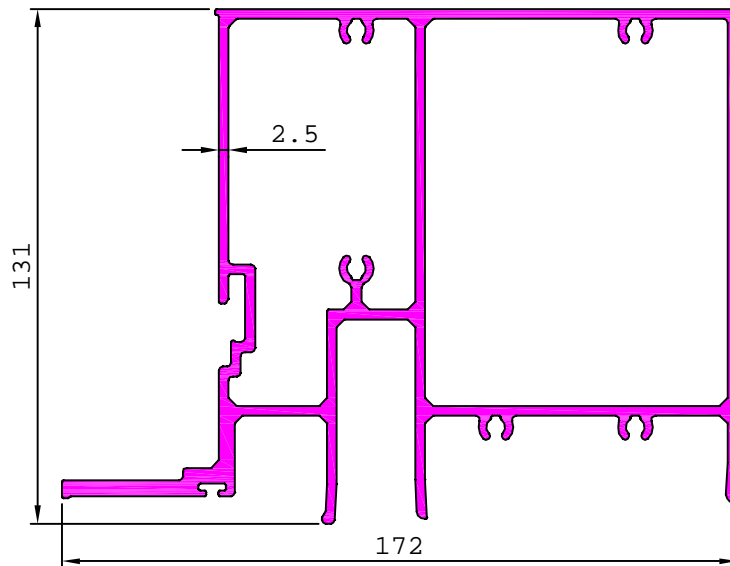

## CURTAIN WALL SECTION-N

29027

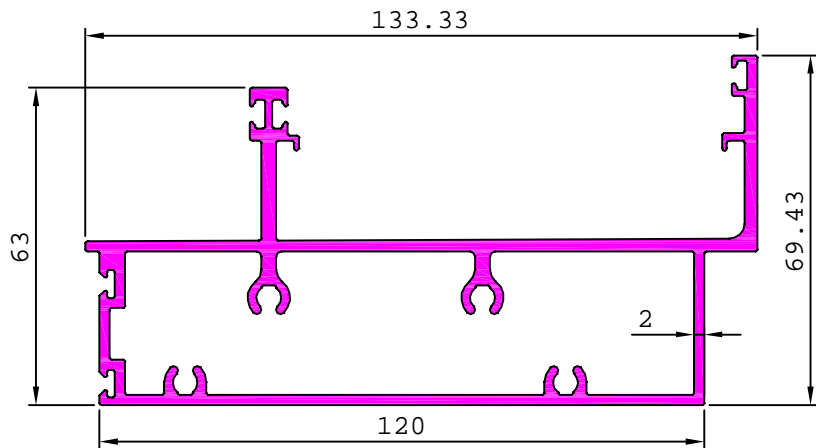

2.809 kg/m

MATCHING WITH 29025

29023

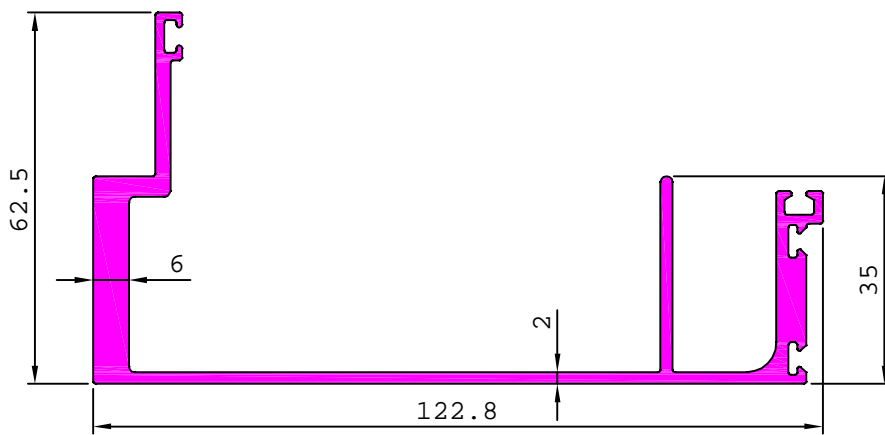

1.967 kg/m

29025

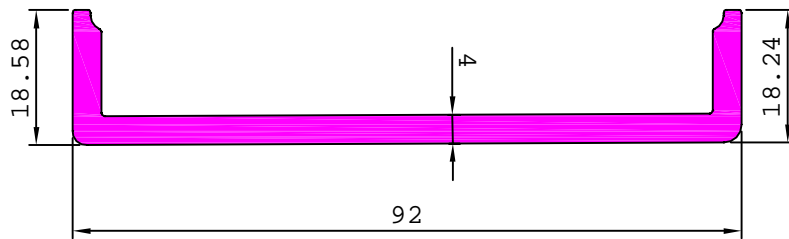

1.281 kg/m

MATCHING WITH 29027

29022

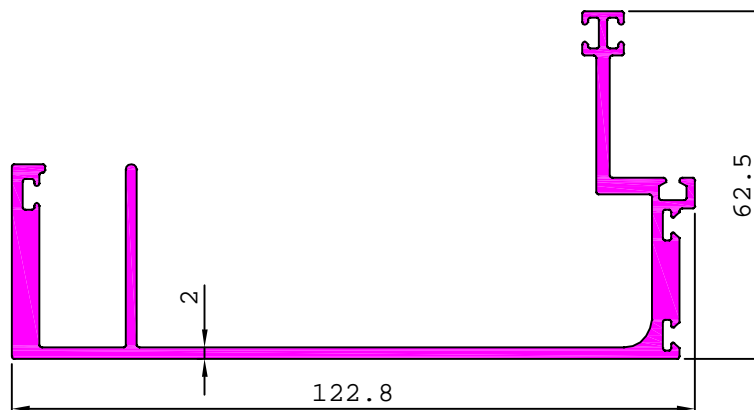

1.902 kg/m

### CURTAIN WALL SECTION-N

29026

2.095 kg/m

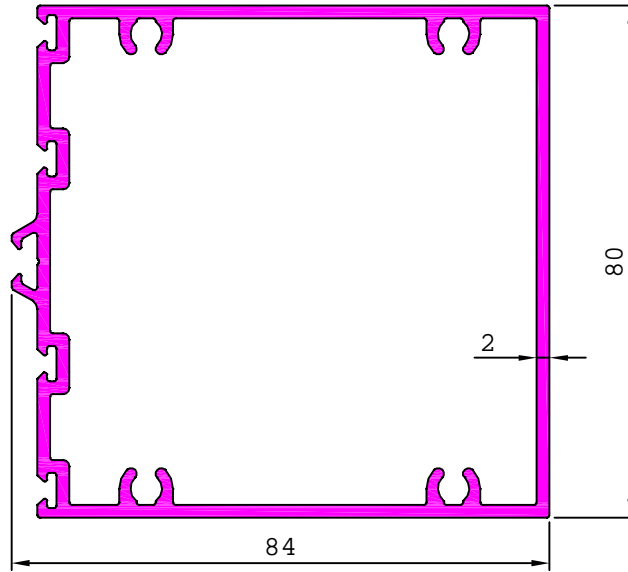

### CURTAIN WALL SECTION-N

S6401

3.001 kg/m

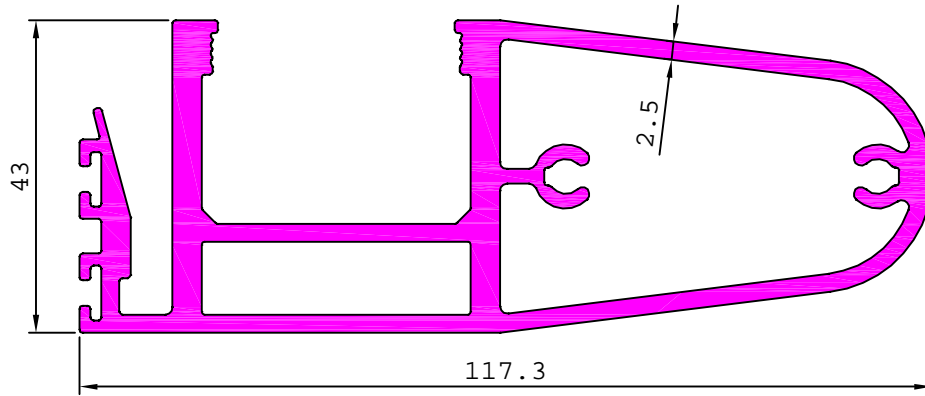

S6403

3.036 kg/m

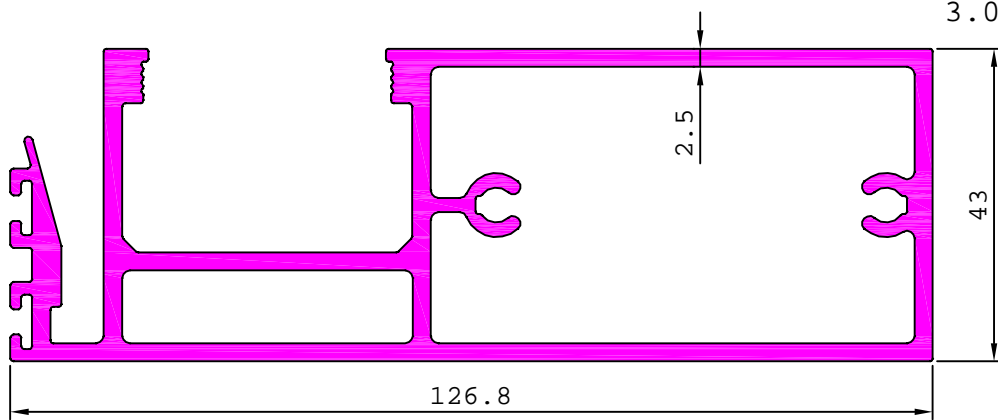

S6402

4.856 kg/m

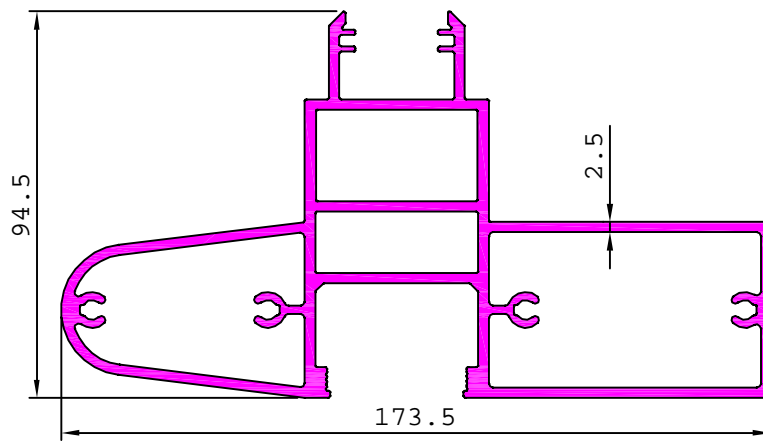

S6427

4.268 kg/m

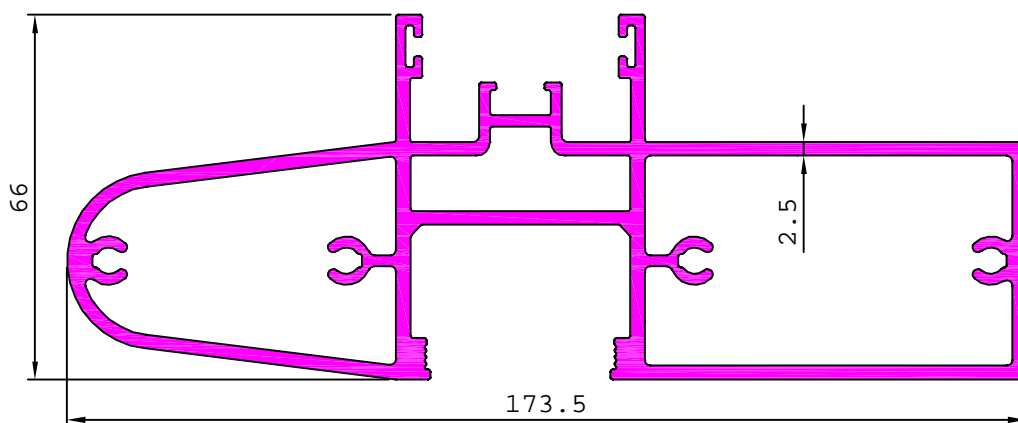

## CURTAIN WALL SECTION-N

S6507

0.339 kg/m

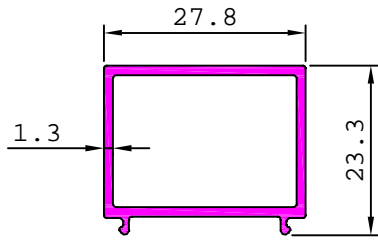

S6506

0.957 kg/m

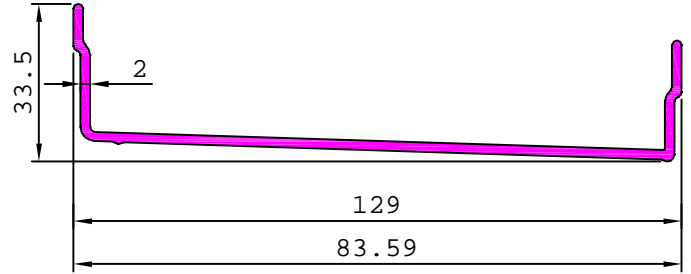

S6502

2.179 kg/m

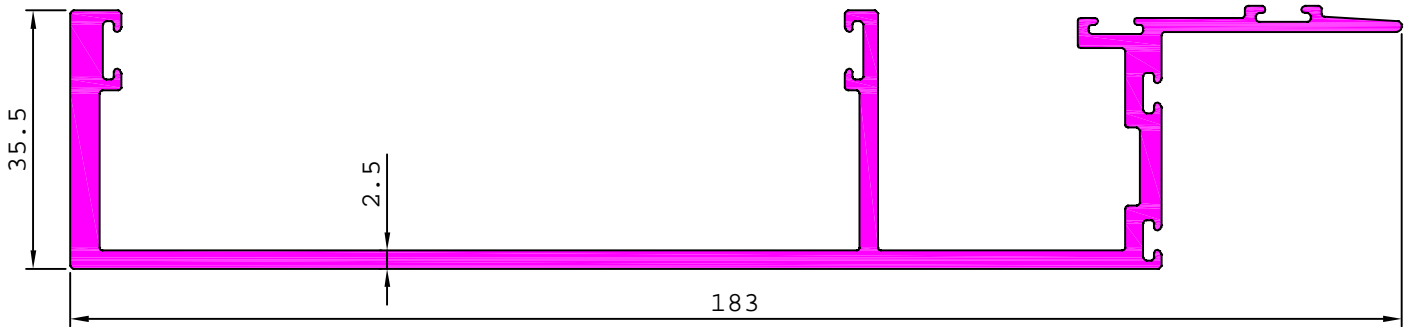

S6504

1.988 kg/m

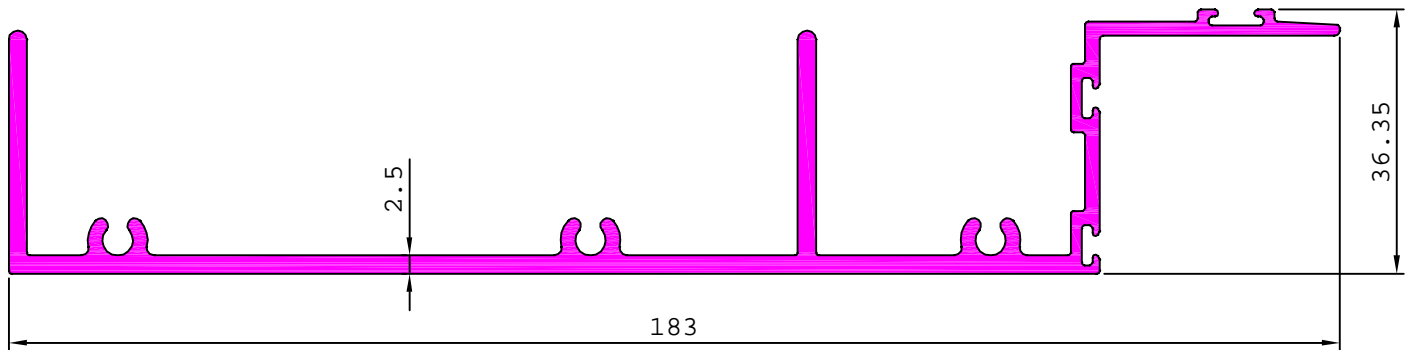

S6501

2.683 kg/m

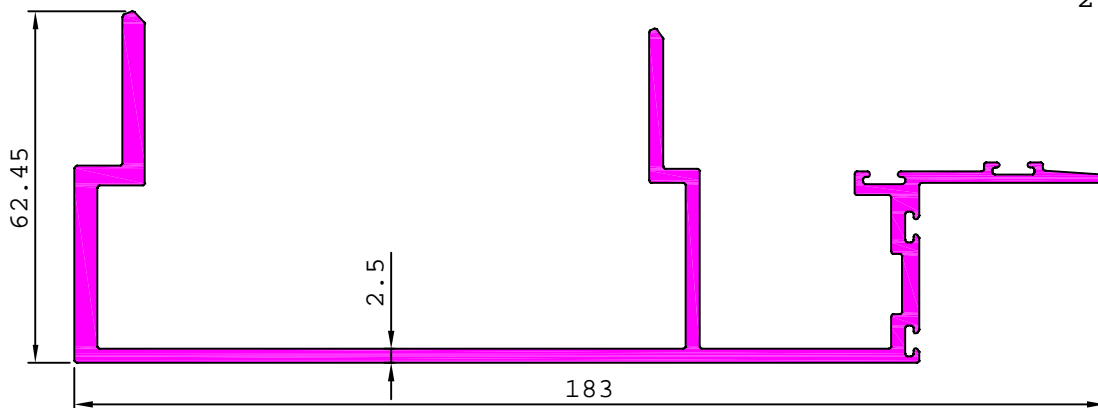

### CURTAIN WALL SECTION-N

S6559

3.869 kg/m

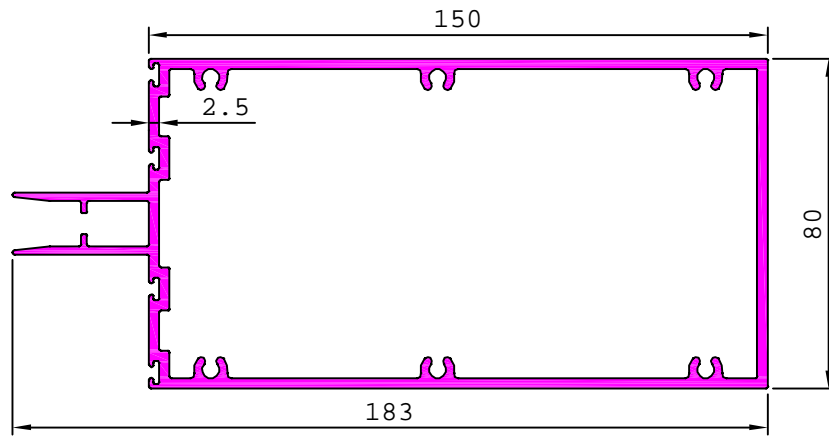

S6503

2.205 kg/m

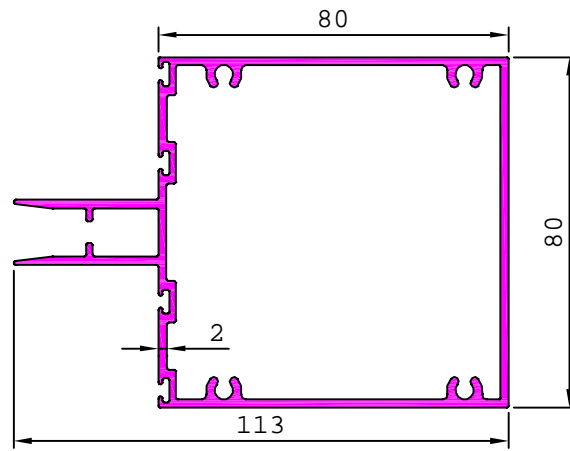

S6505

3.648 kg/m

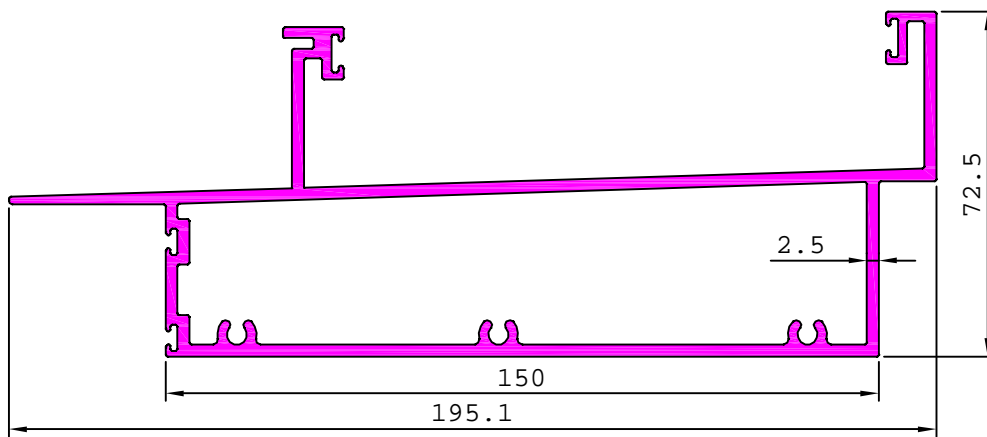

## CURTAIN WALL SECTION-N

S6606

0.522 kg/m

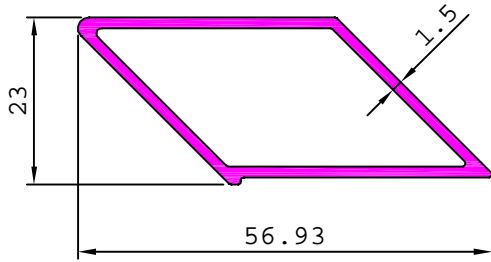

S6615

0.335 kg/m

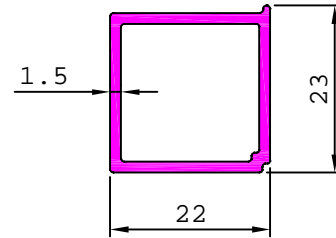

S6609

0.291 kg/m

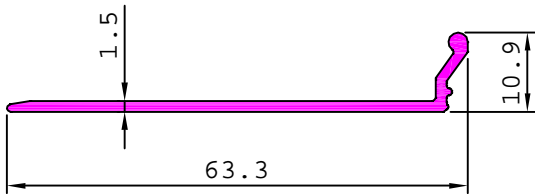

S6614

1.611 kg/m

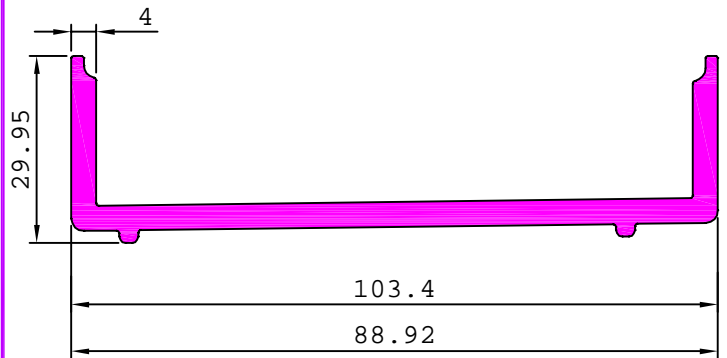

S6608

0.832 kg/m

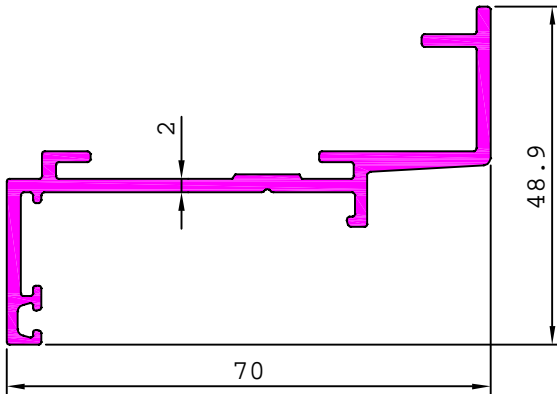

S6607

1.378 kg/m

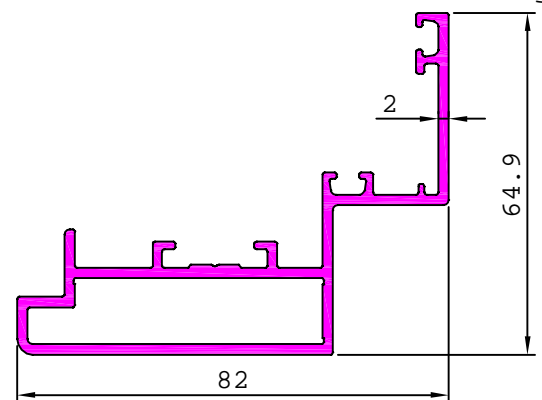

S6610

2.784 kg/m

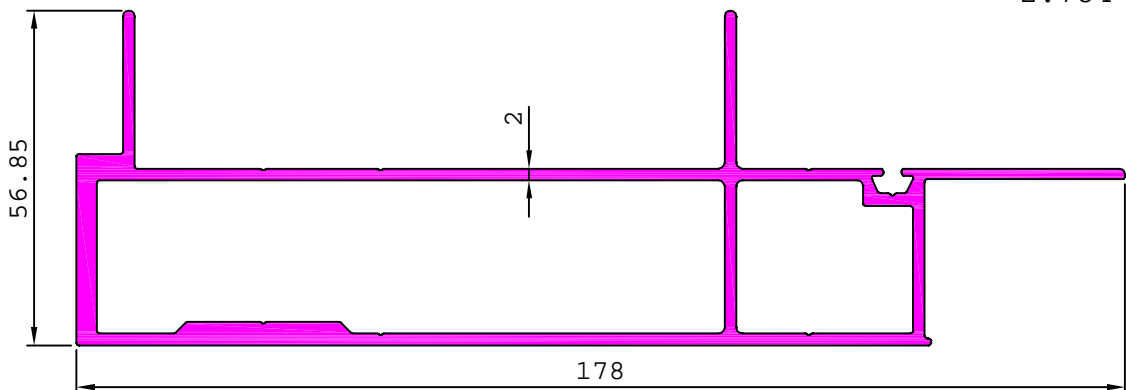

### CURTAIN WALL SECTION-N

S6612

2.094 kg/m

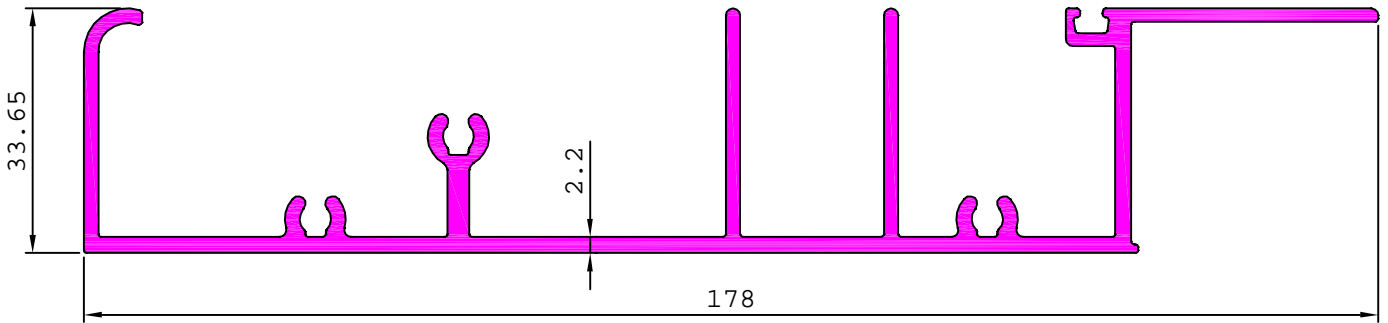

S6611

2.511 kg/m

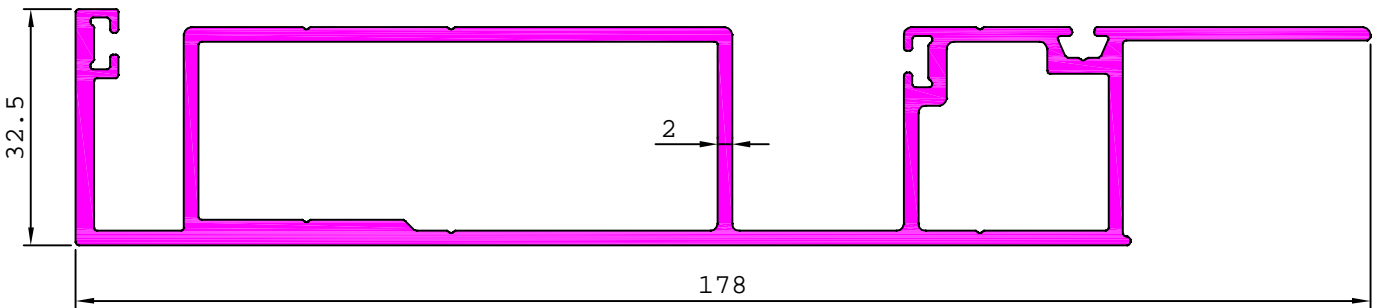

S6613

3.146 kg/m

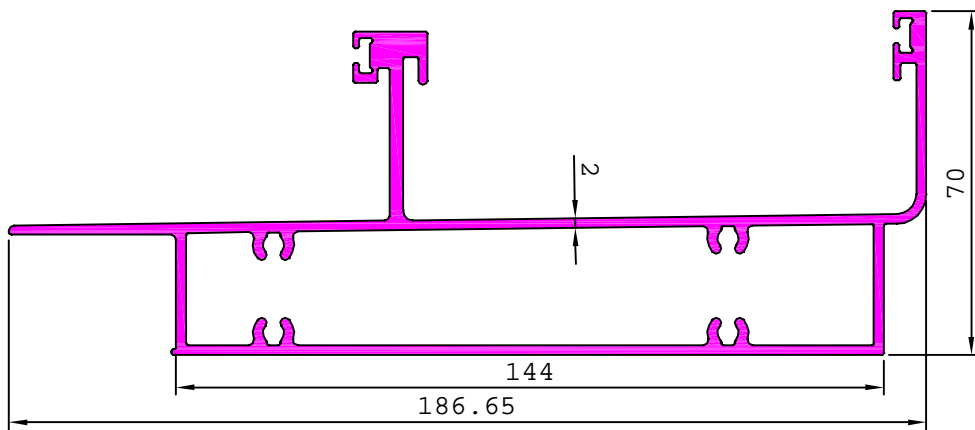

S6604

2.956 kg/m

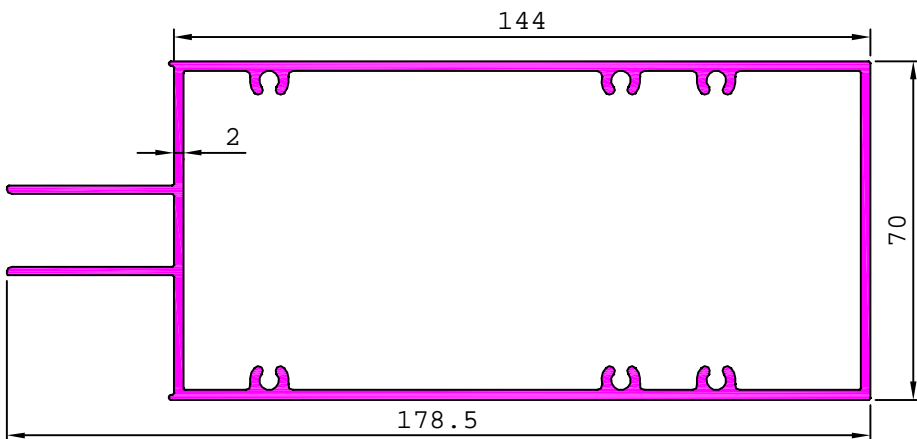

### CURTAIN WALL SECTION-N

S6790

3.322 kg/m

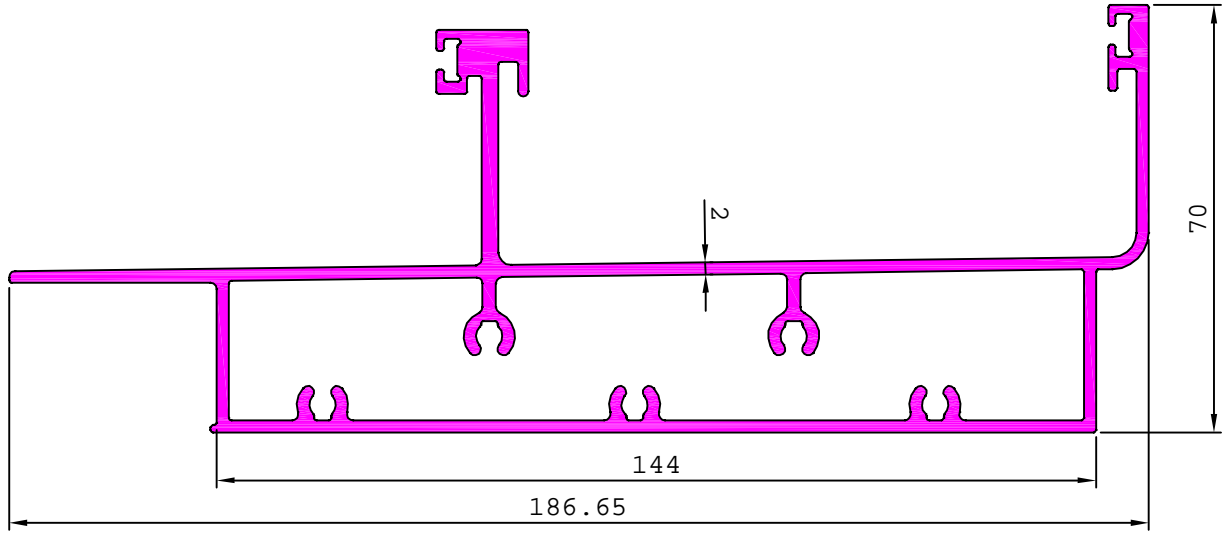

S6443

4.432 kg/m

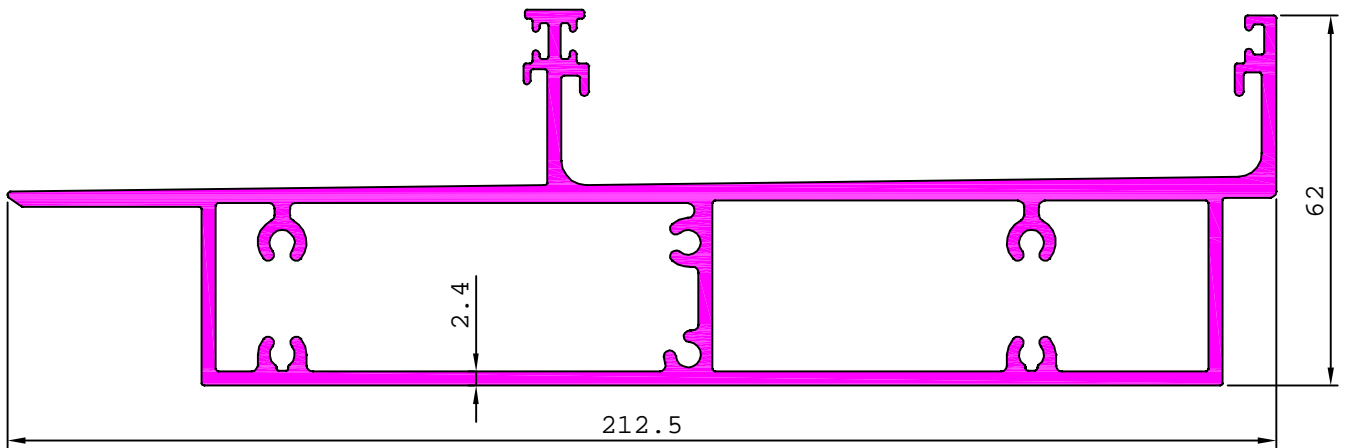

S6448

5.844 kg/m

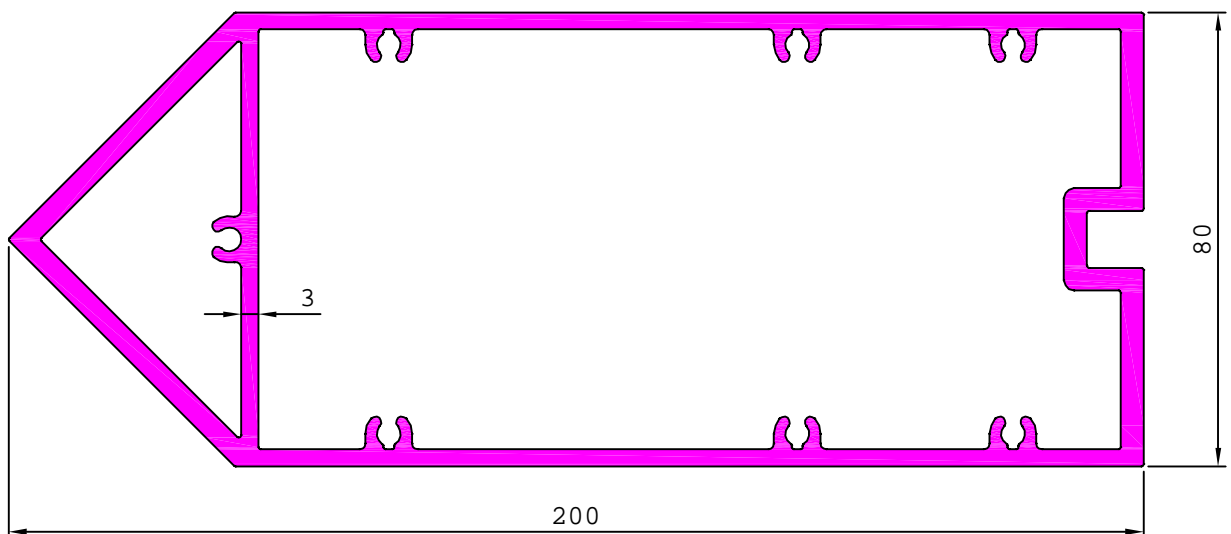

## CURTAIN WALL SECTION-O

S6436

0.737 kg/m

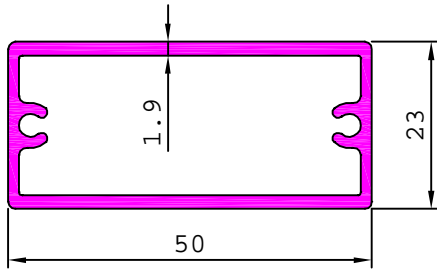

S6444

0.658 kg/m

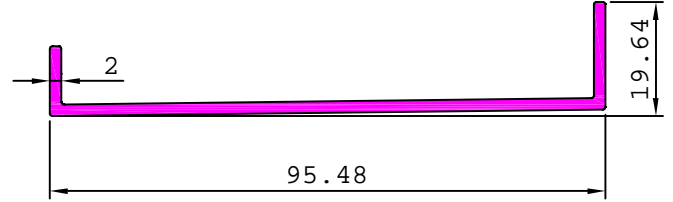

S6447

0.372 kg/m

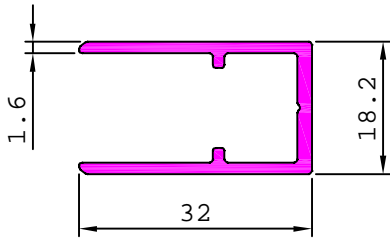

S6452

0.188 kg/m

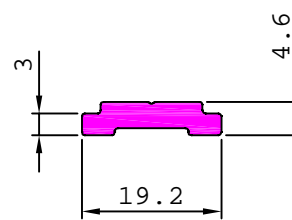

S6449

1.435 kg/m

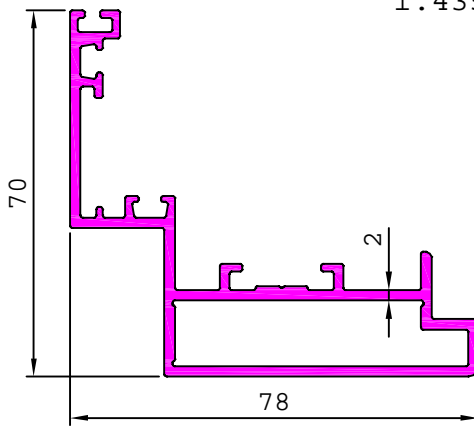

S6450

0.821 kg/m

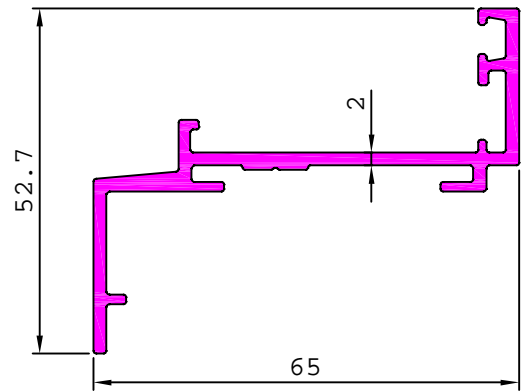

S6445

1.049 kg/m

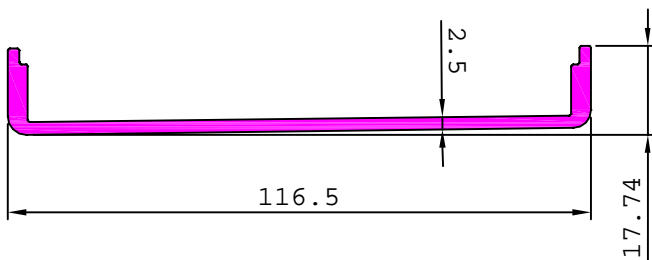

S6453

0.553 kg/m

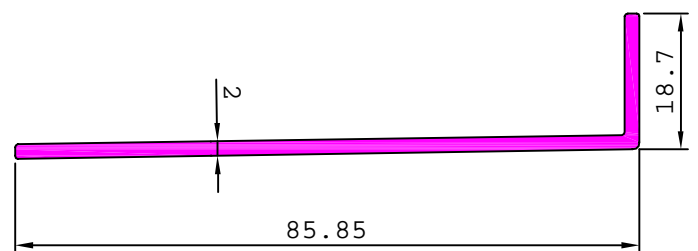

## CURTAIN WALL SECTION-O

S6446

1.982 kg/m

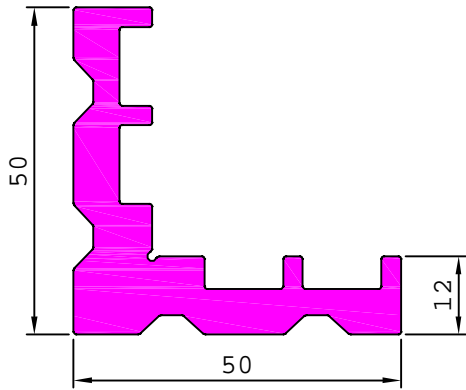

S6451

2.342 kg/m

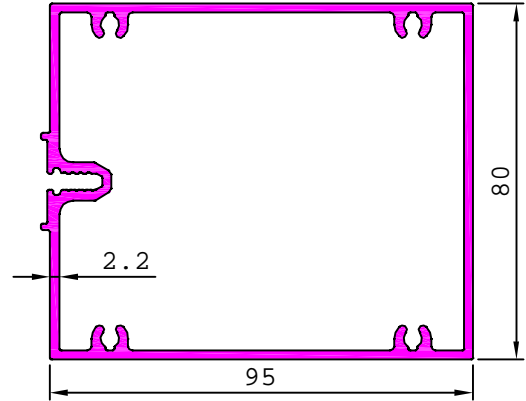

S6441

2.934 kg/m

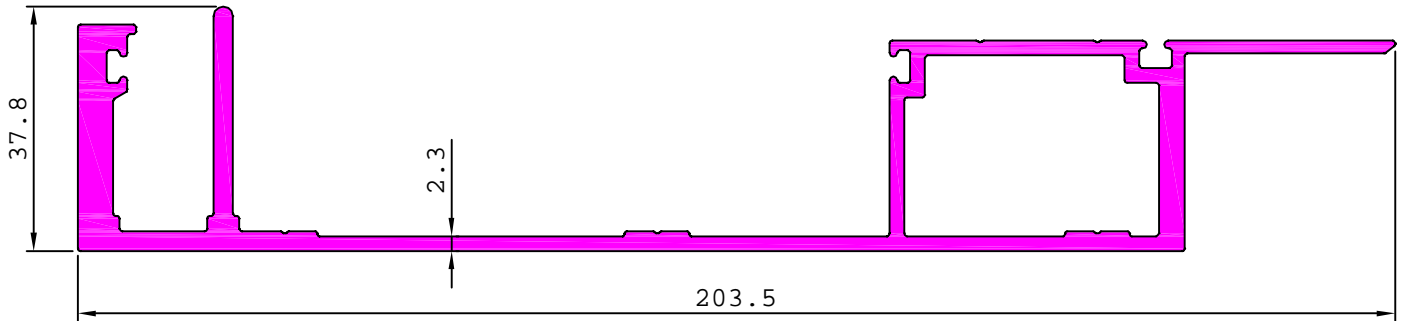

S6440

3.211 kg/m

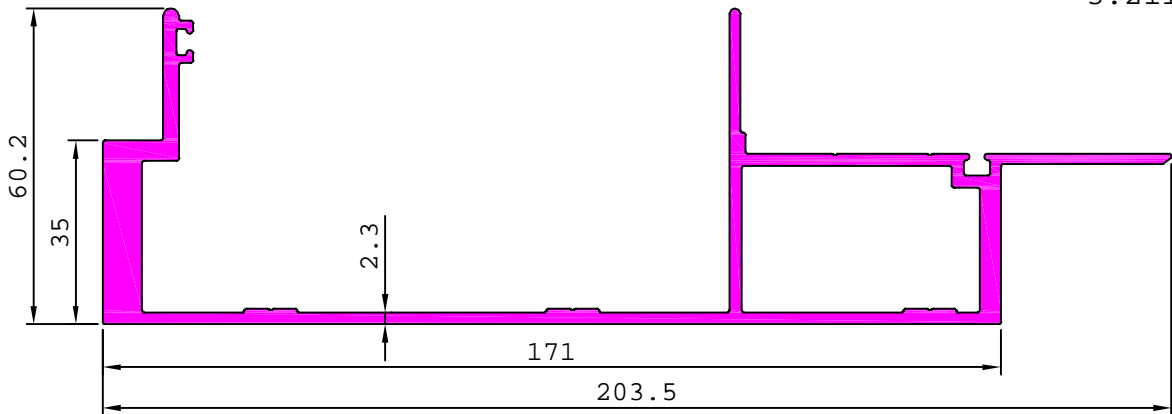

36160

3.462 kg/m

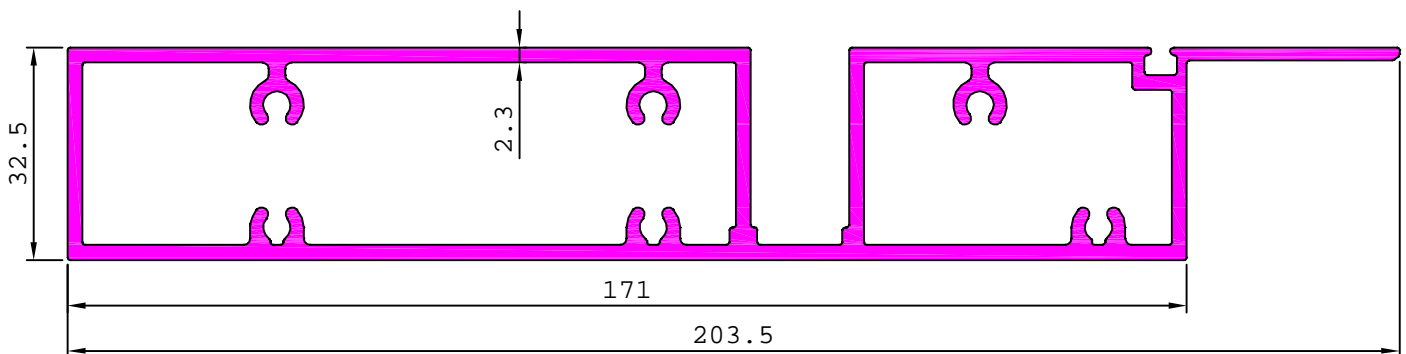

### CURTAIN WALL SECTION-O

S6639

4.792 kg/m

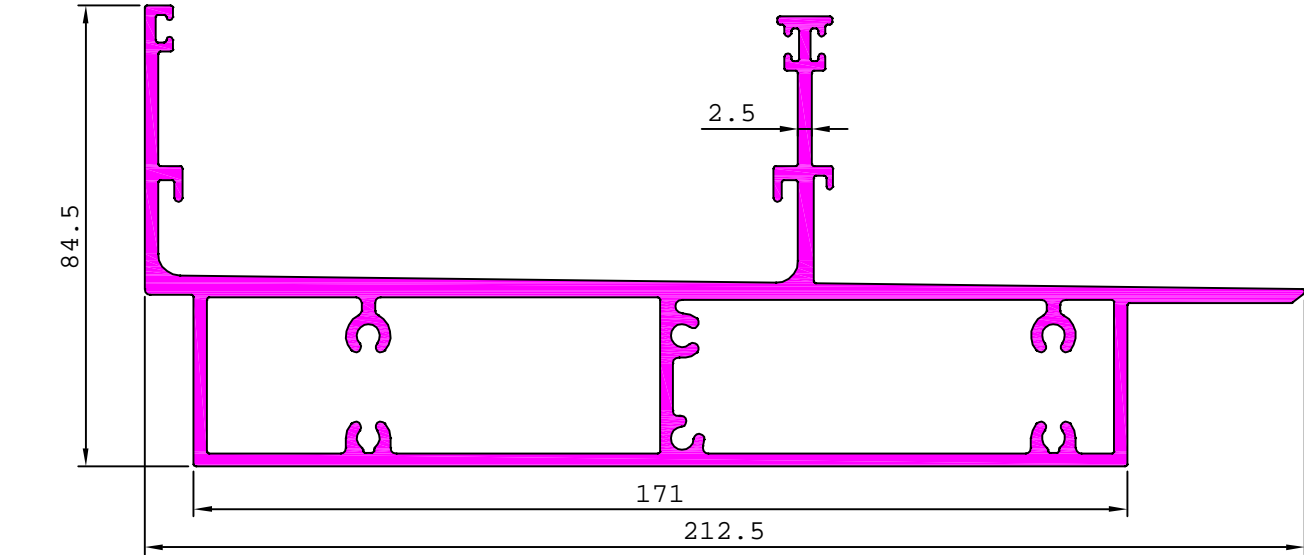

S6640

3.304 kg/m

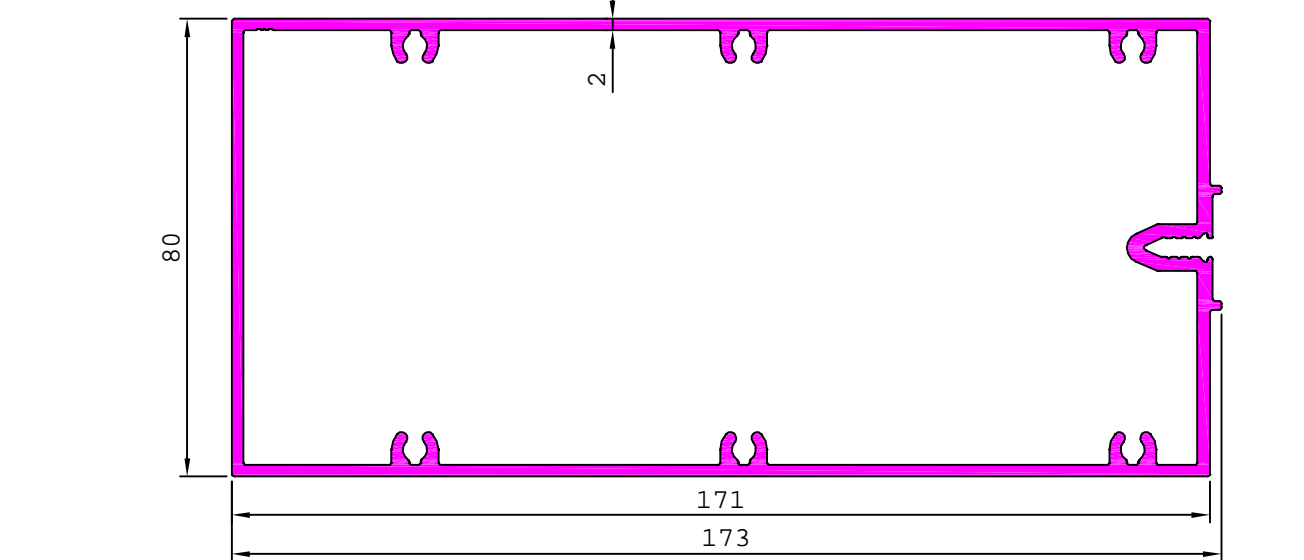

S6638

3.835 kg/m

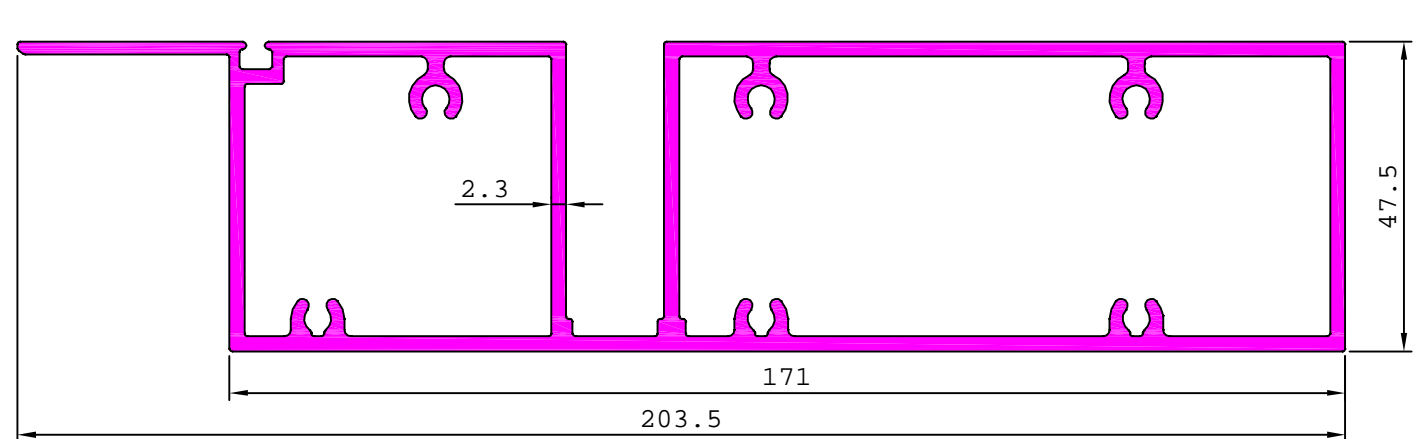

## CURTAIN WALL SECTION-O

S6666

0.338 kg/m

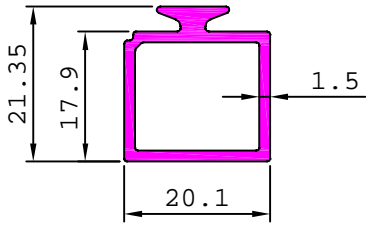

MATCHING WITH S6663,36228

S6805

0.465 kg/m

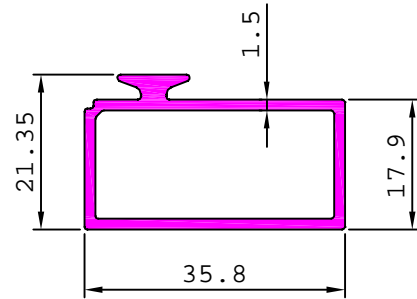

S6669

0.336 kg/m

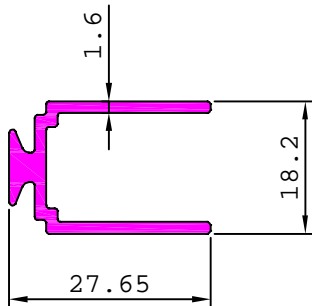

MATCHING WITH 36229

S6667

0.990 kg/m

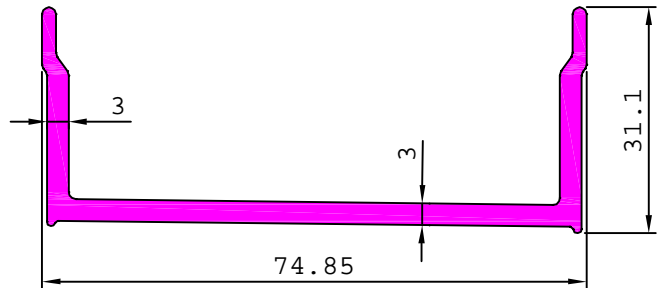

S6742

3.289 kg/m

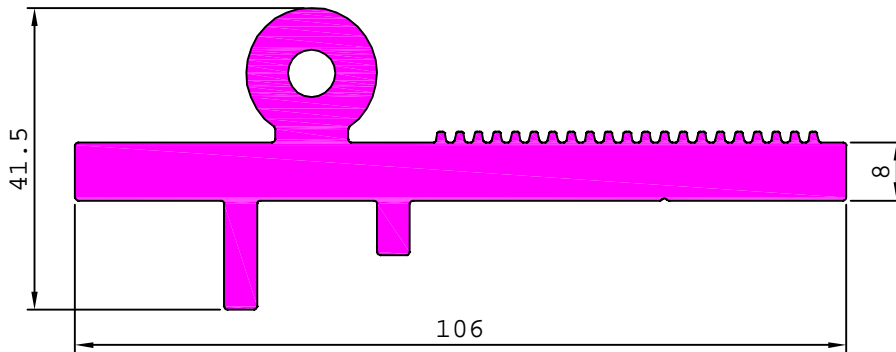

S6663

3.083 kg/m

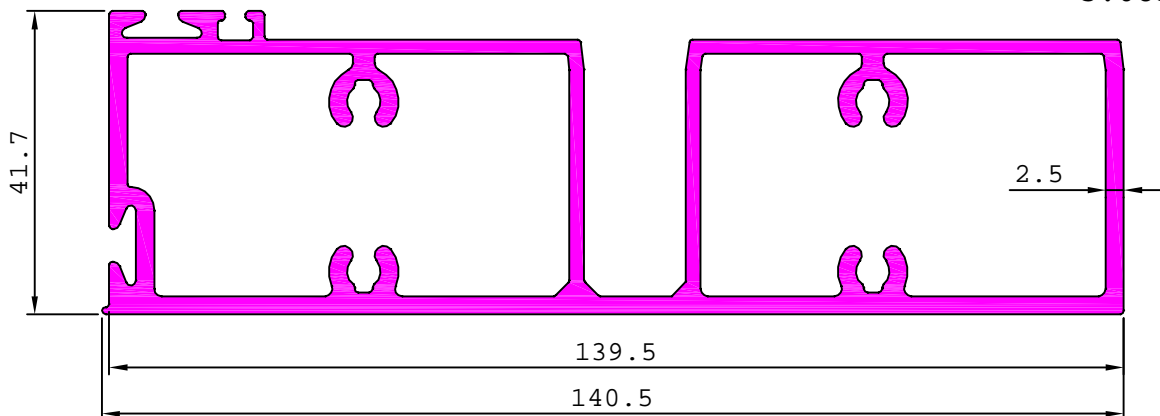

## CURTAIN WALL SECTION-P

36229

3.460 kg/m

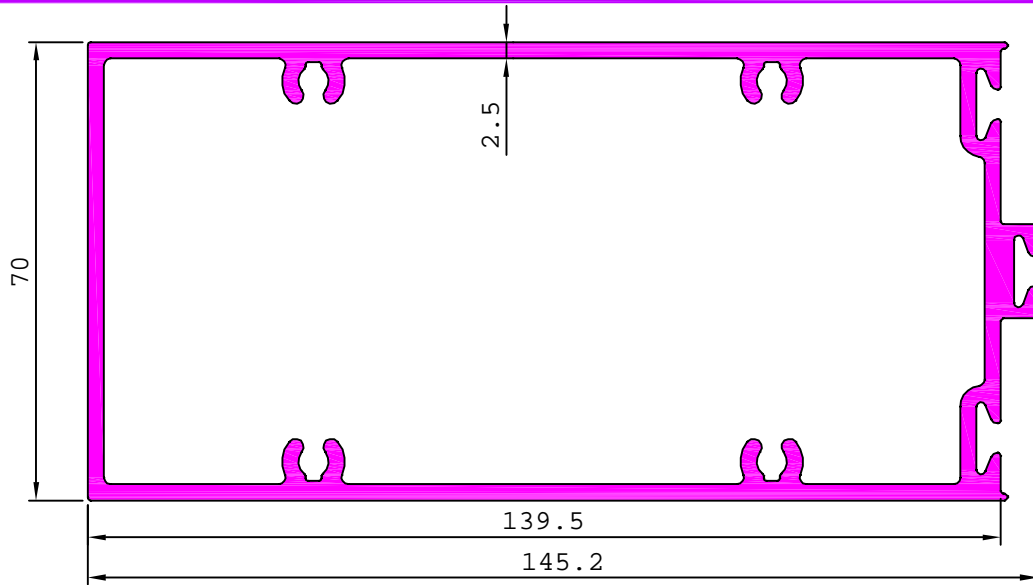

MATCHING WITH S6669,G103193,G103194

36228

3.574 kg/m

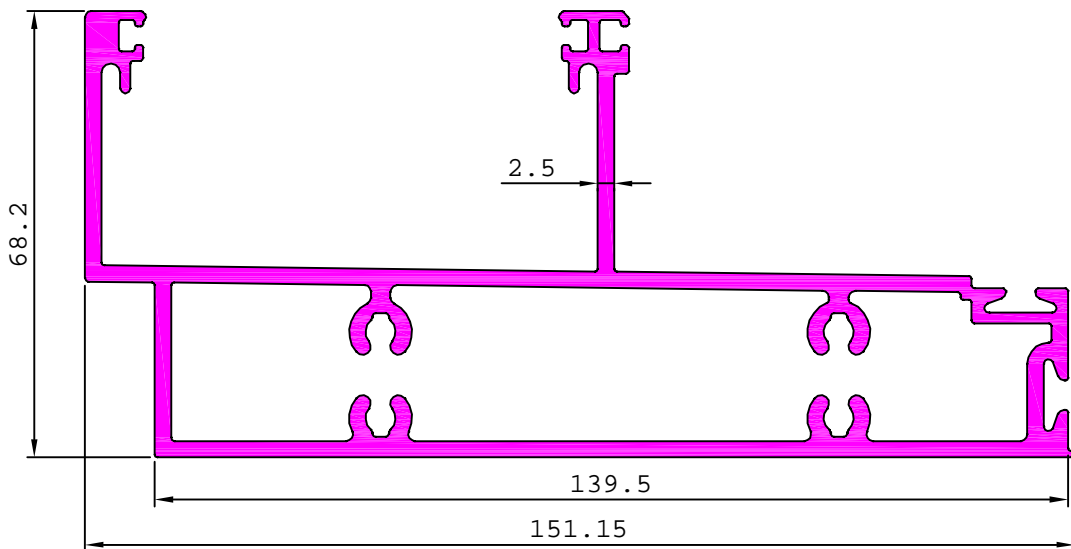

36230

2.252 kg/m

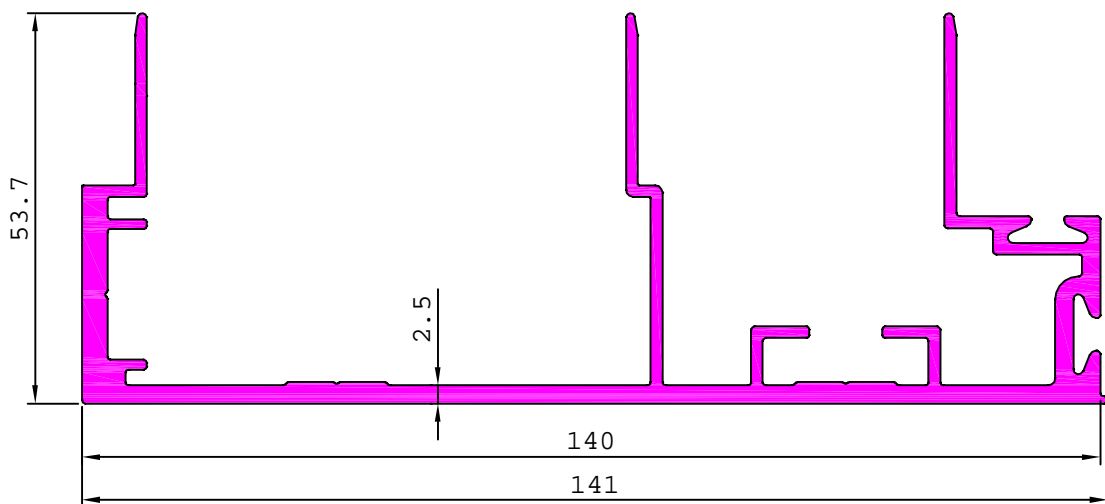

MATCHING WITH G103195,G103196

## CURTAIN WALL SECTION-P

36231

1.925 kg/m

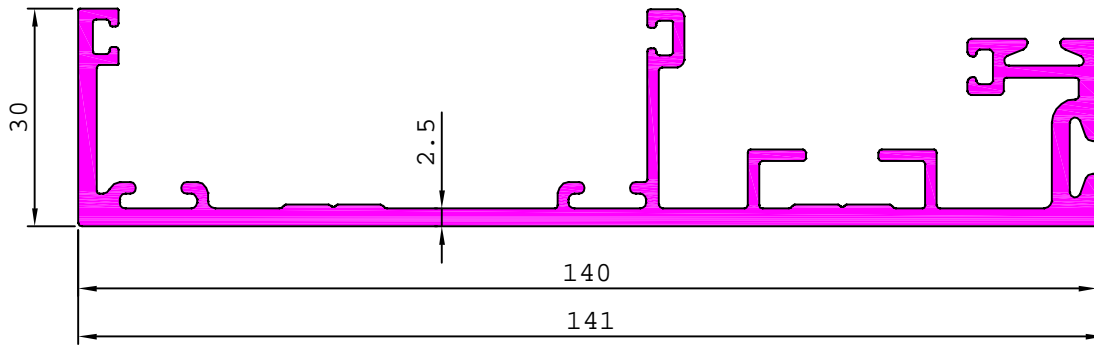

MATCHING WITH G103195,G103196

S6804

3.343 kg/m

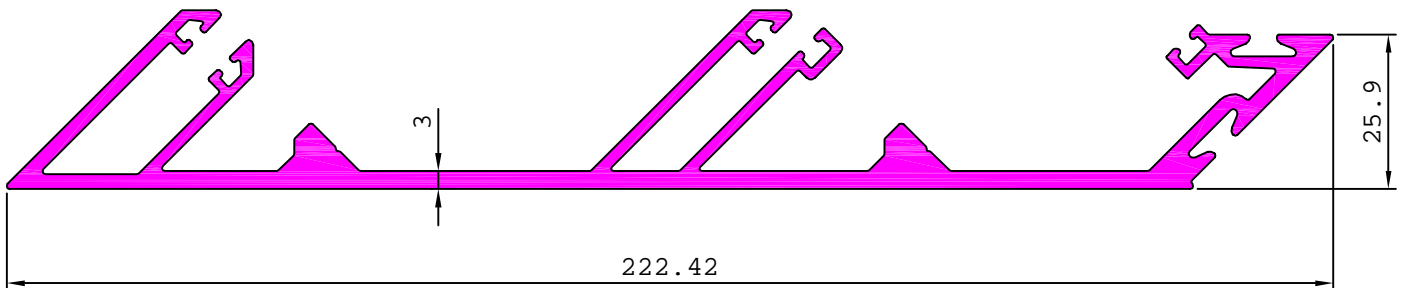

MATCHING WITH G103213,G103214

36194

4.854 kg/m

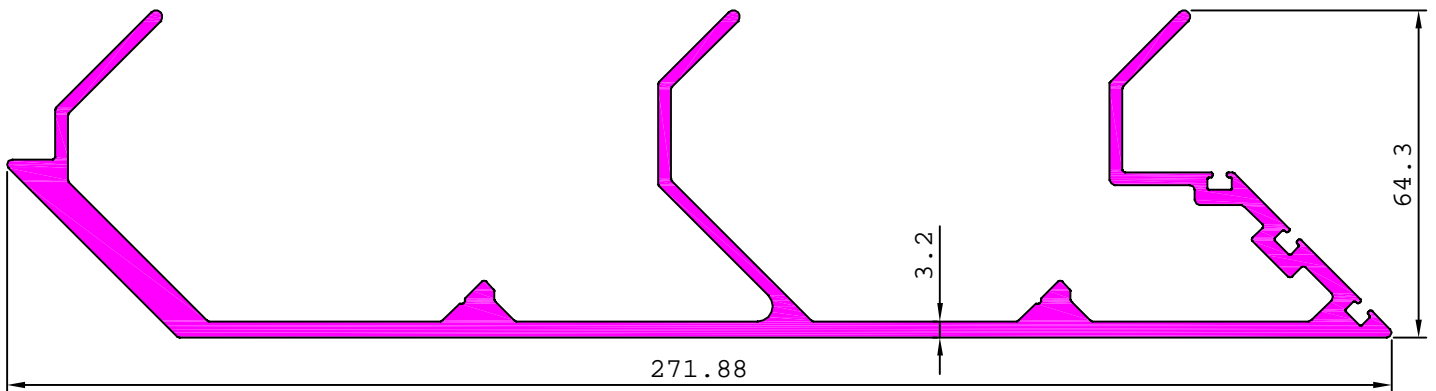

## CURTAIN WALL SECTION-Q

S6672

0.184 kg/m

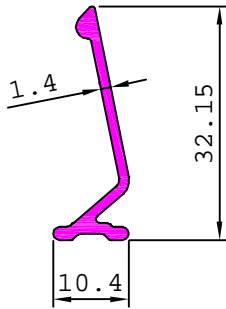

S6673

0.267 kg/m

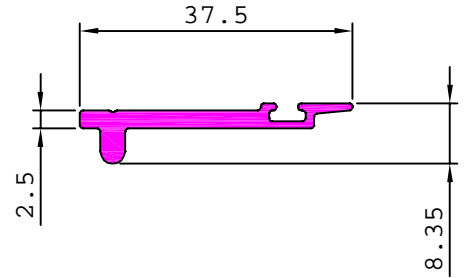

S6674

0.241 kg/m

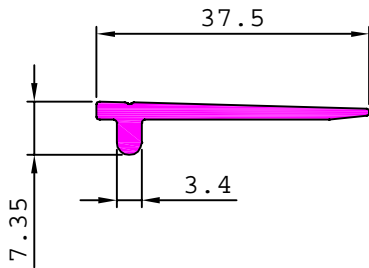

S6675

0.412 kg/m

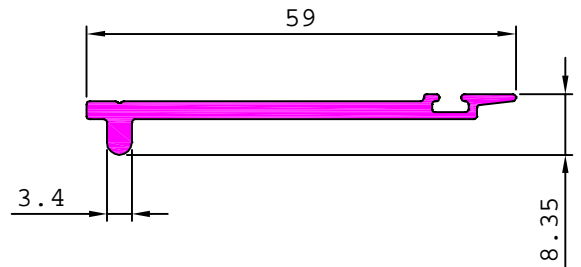

S6668

0.238 kg/m

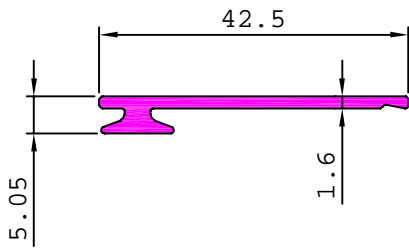

S6676

0.339 kg/m

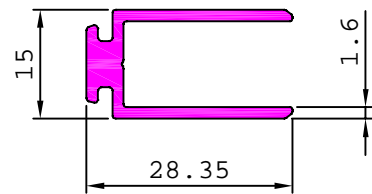

**MATCHING WITH S6677**

S6684

0.213 kg/m

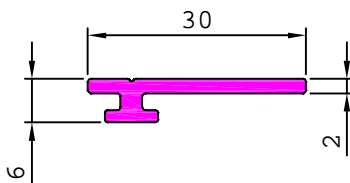

S6694

0.217 kg/m

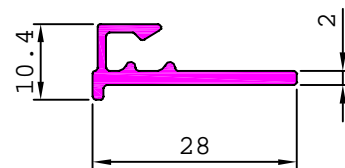

**MATCHING WITH S6693**

## CURTAIN WALL SECTION-Q

S6689

0.389 kg/m

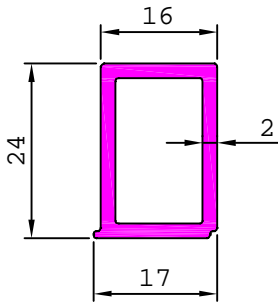

S6692

0.565 kg/m

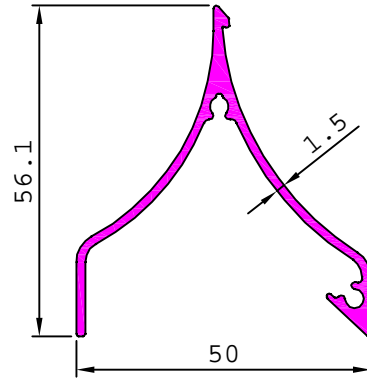

S6690

0.966 kg/m

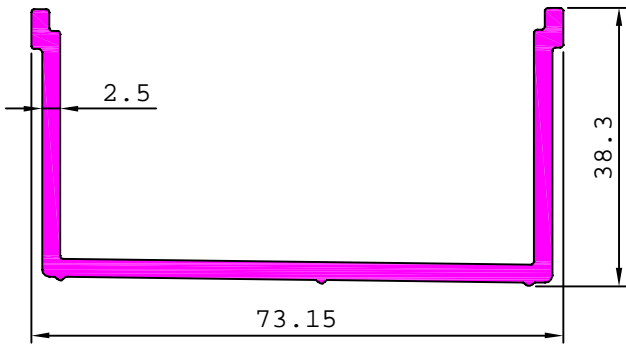

S6691

1.318 kg/m

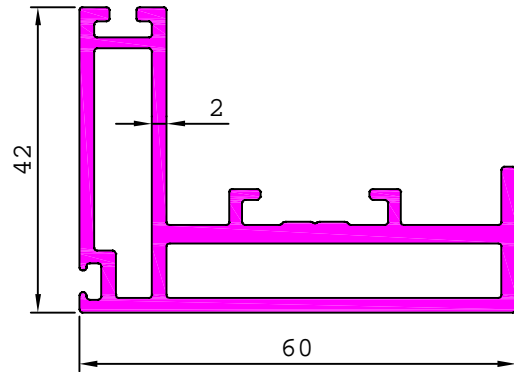

S6693

1.718 kg/m

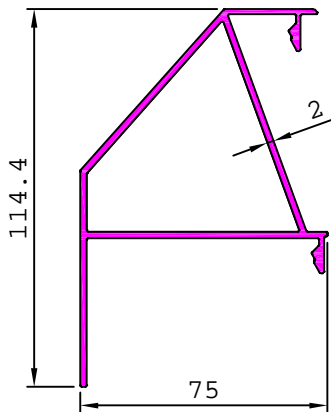

S6688

1.166 kg/m

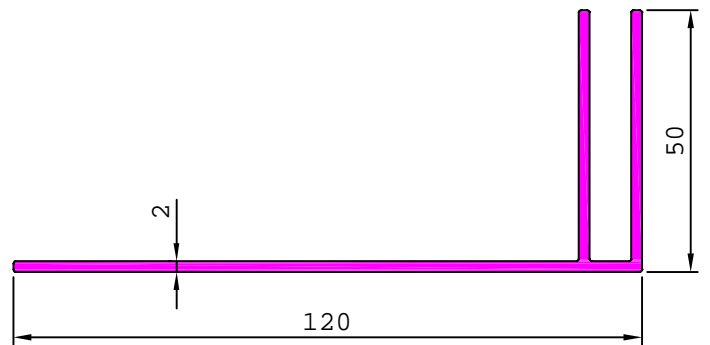

S6685

8.827 kg/m

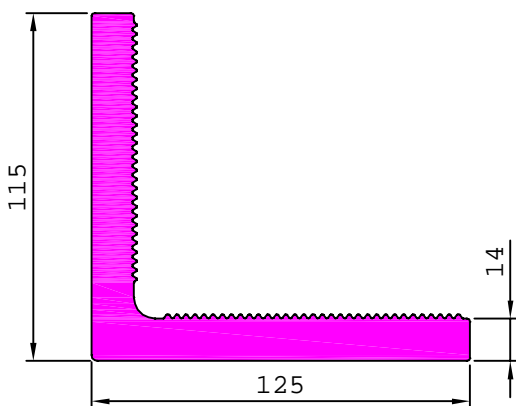

S6686

4.266 kg/m

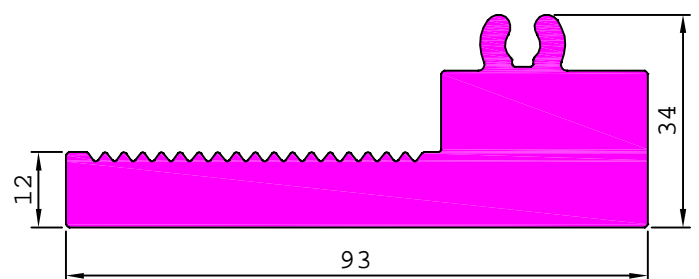

## CURTAIN WALL SECTION-Q

S6683

3.403 kg/m

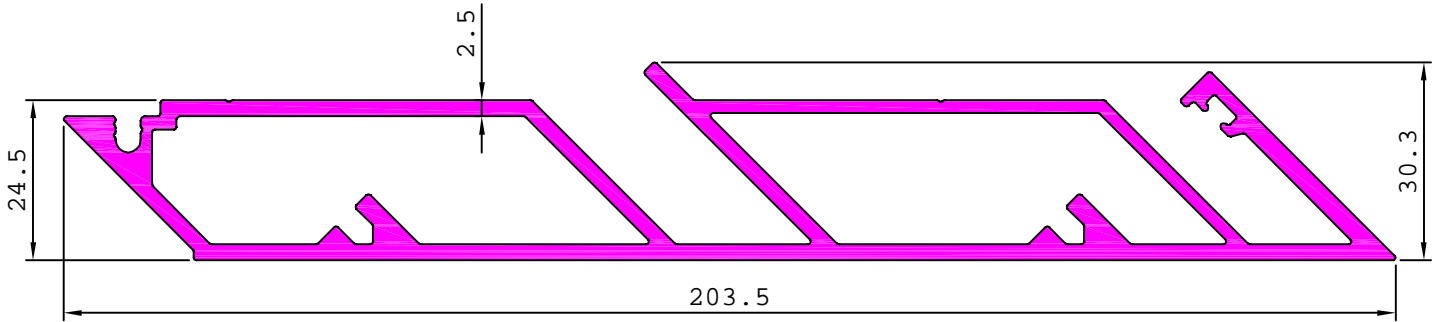

S6680

2.671 kg/m

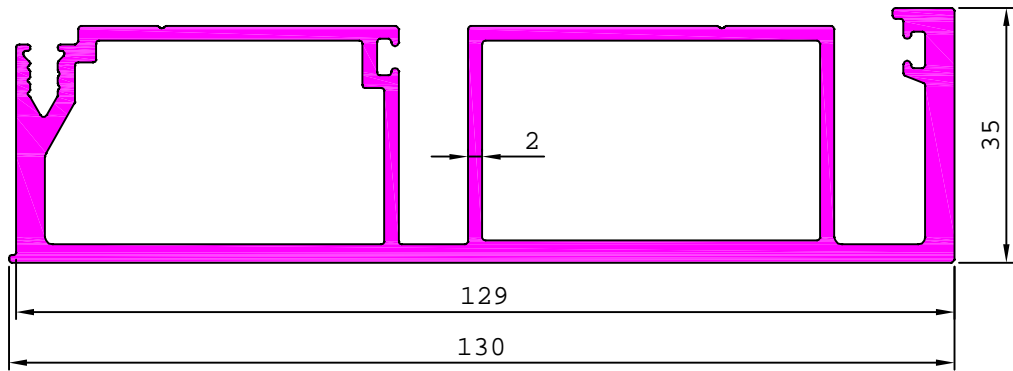

S6682

3.898 kg/m

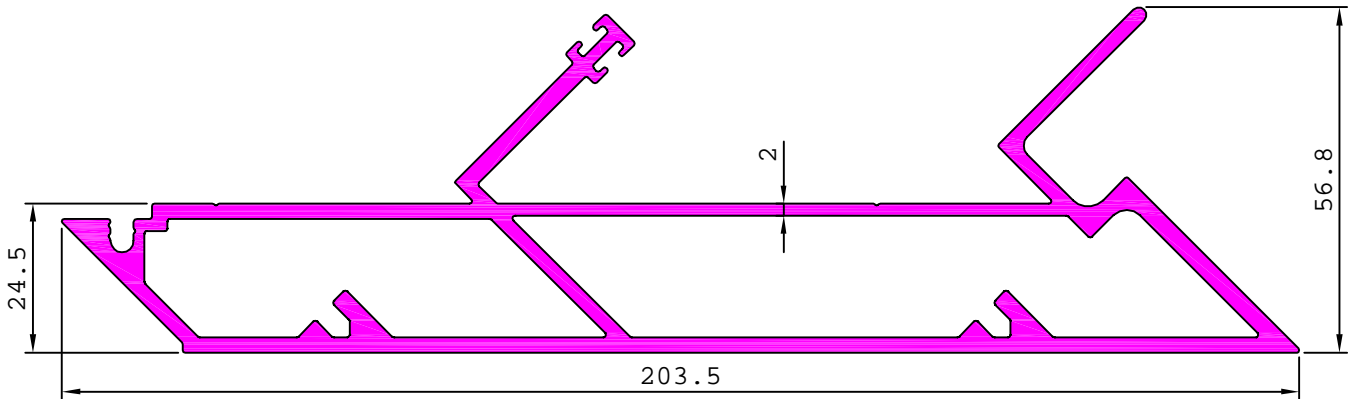

S6678

3.011 kg/m

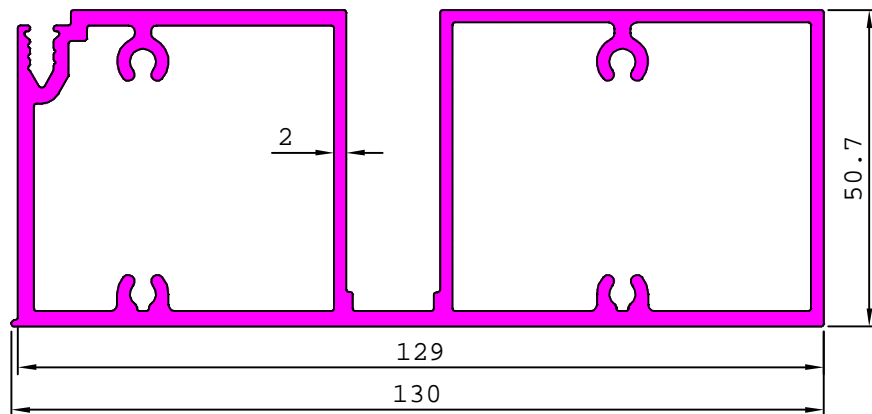

## CURTAIN WALL SECTION-R

S6677

2.678 kg/m

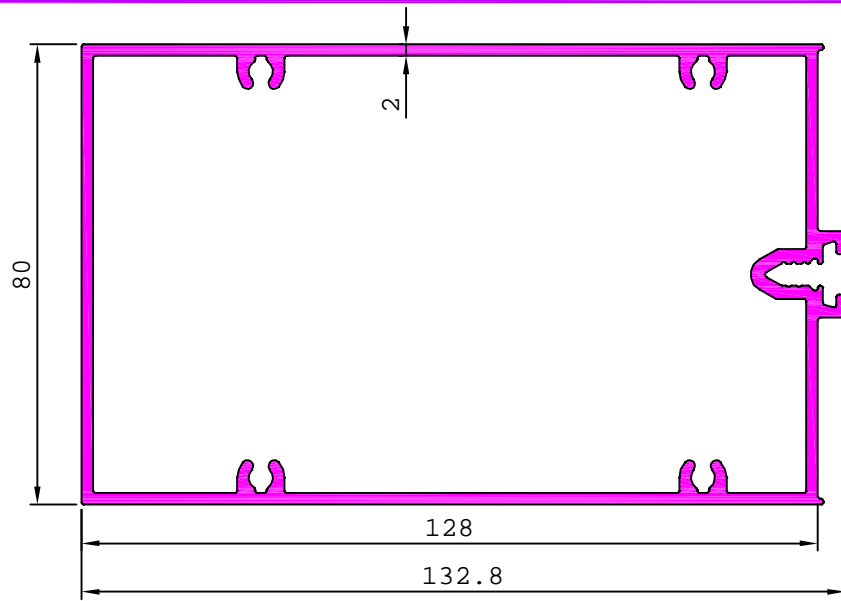

S6679

3.194 kg/m

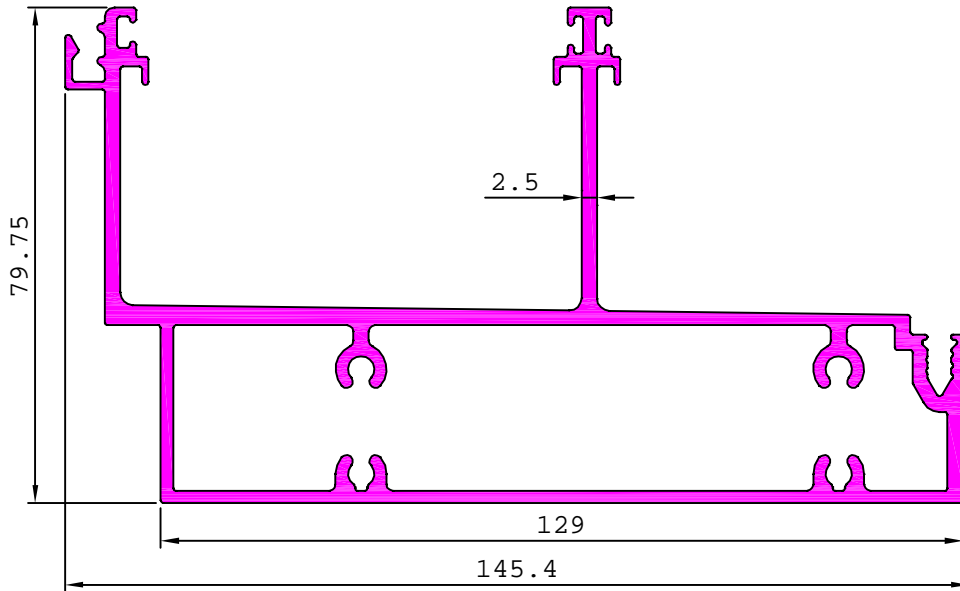

S6681

2.940 kg/m

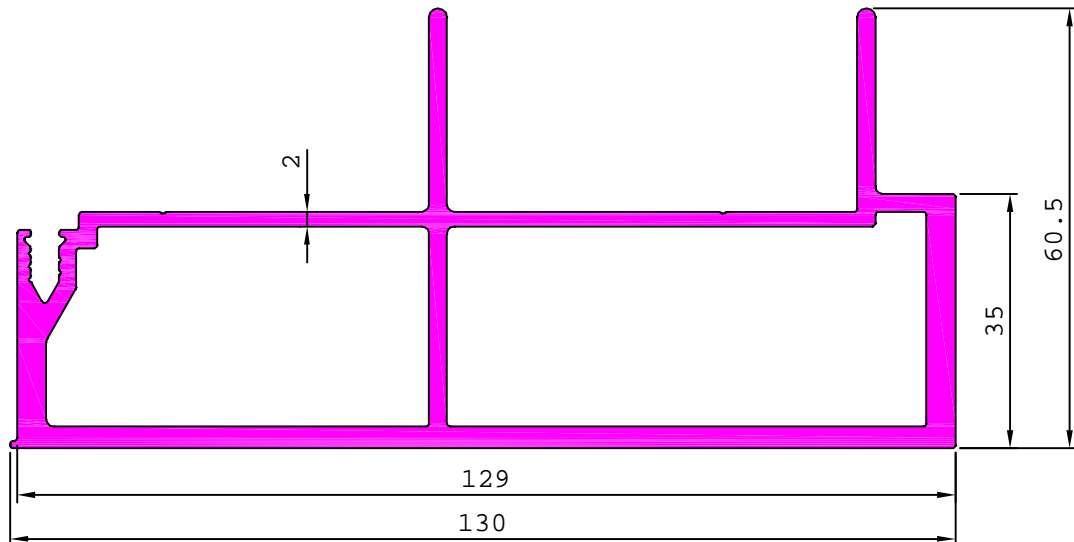

## CURTAIN WALL SECTION-R

36317

0.264 kg/m

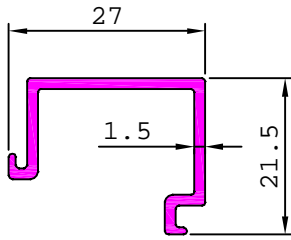

MATCHING WITH G102650,G102651

S6736

1.068 kg/m

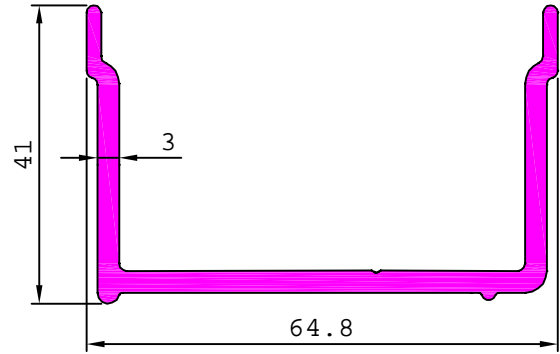

S6735

0.564 kg/m

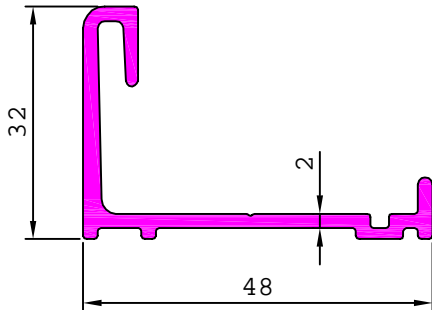

S6737

1.537 kg/m

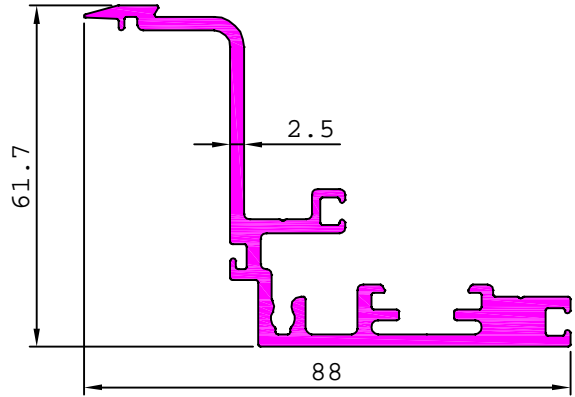

S6707

1.593 kg/m

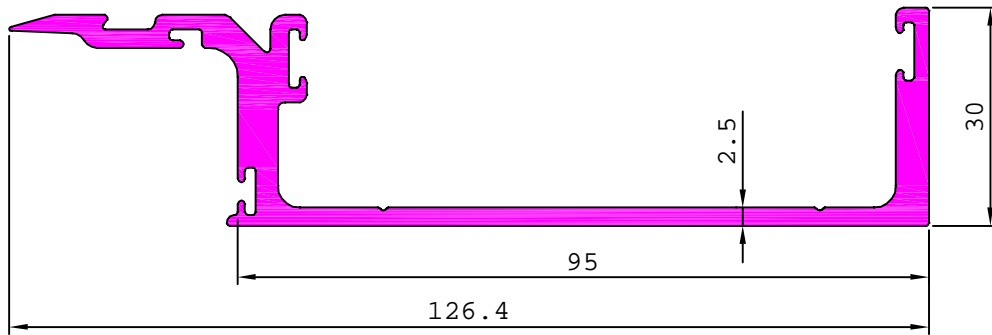

S6708

2.107 kg/m

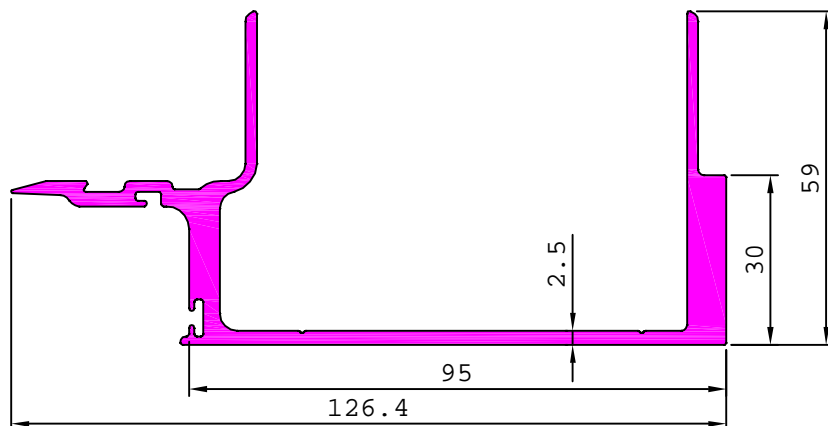

# CURTAIN WALL SECTION-R

S6709

2.145 kg/m

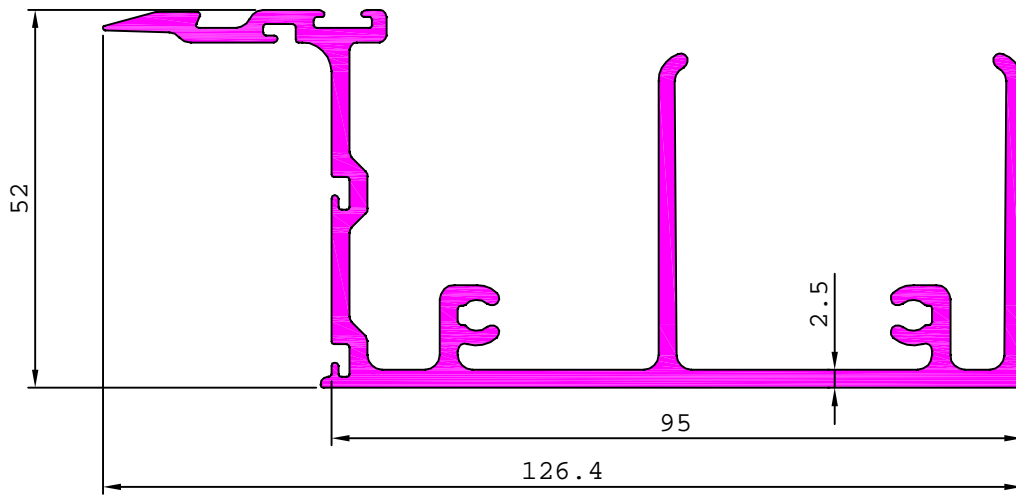

S6711

3.146 kg/m

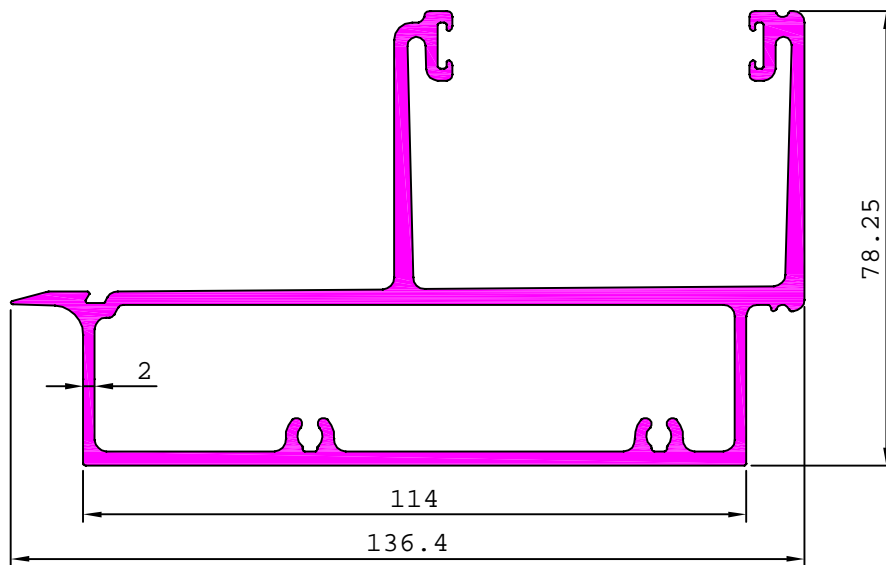

S6712

2.955 kg/m

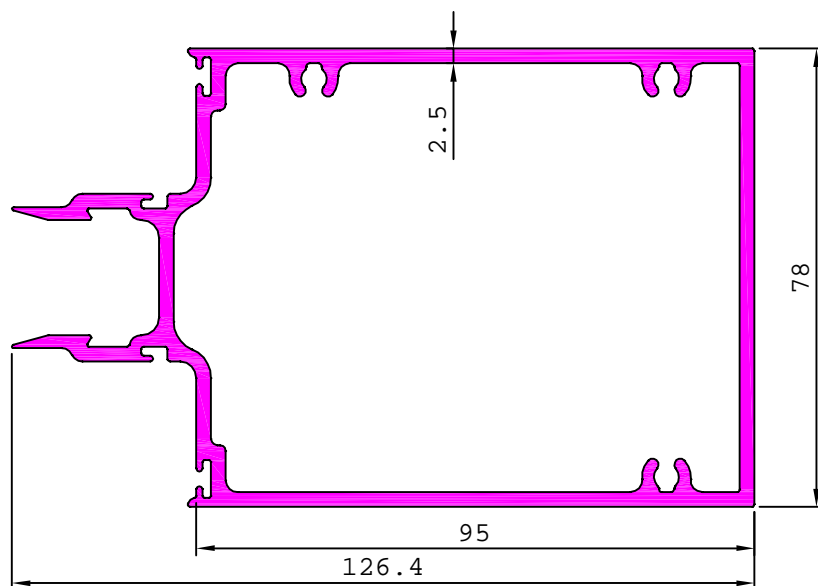

## CURTAIN WALL SECTION-S

S6744

4.625 kg/m

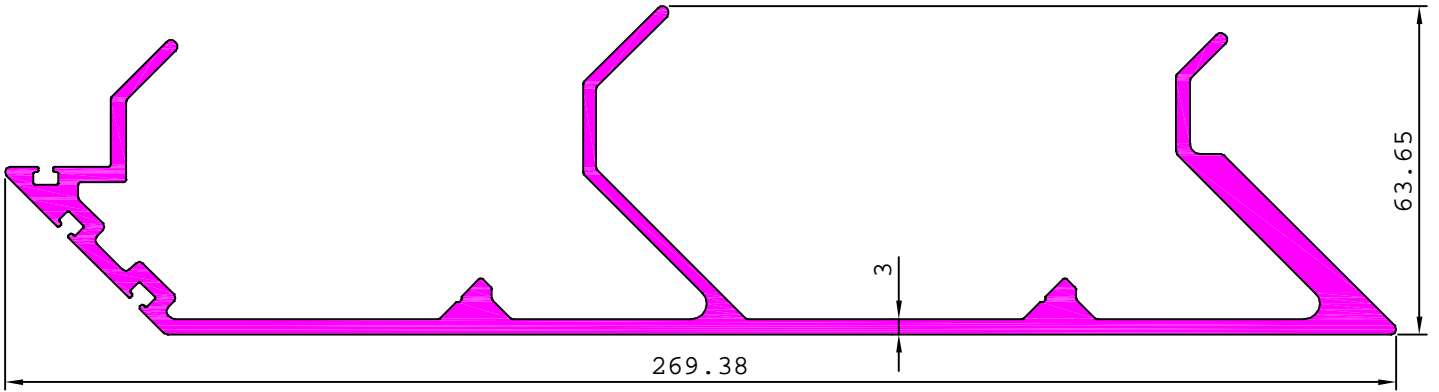

S6745

3.911 kg/m

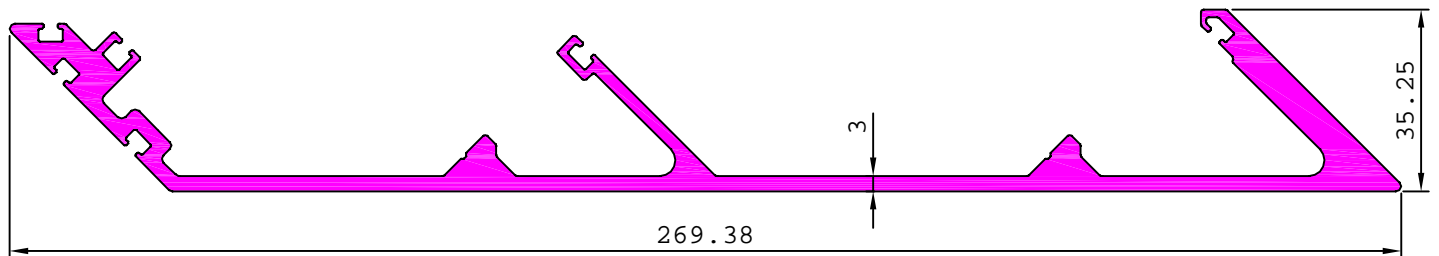

S6803

3.419 kg/m

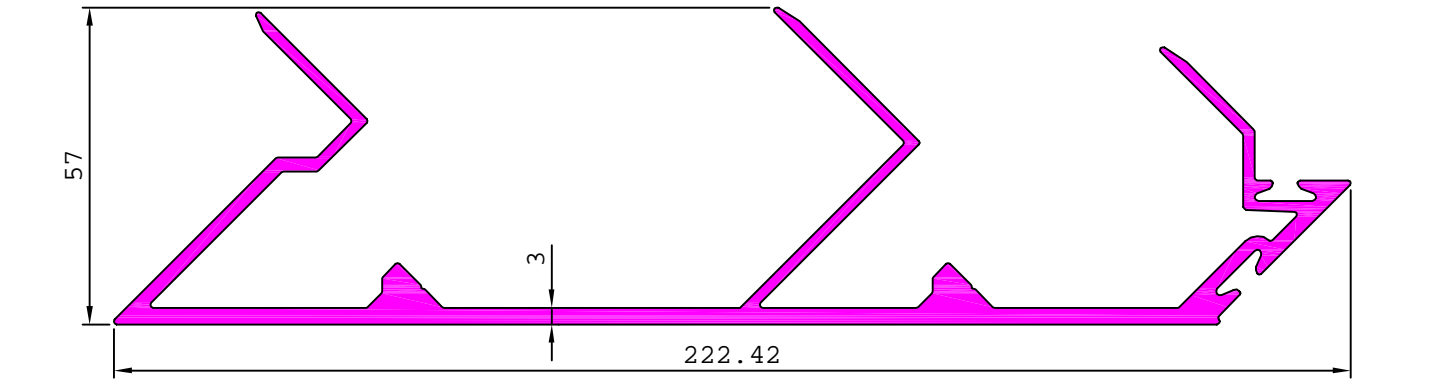

MATCHING WITH G103213,G103214

36193

4.043 kg/m

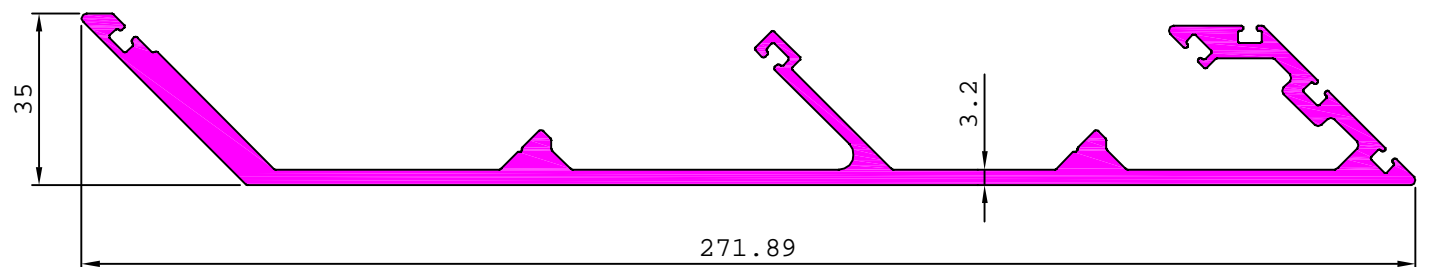

### CURTAIN WALL SECTION-T

36204 2.170 kg/m

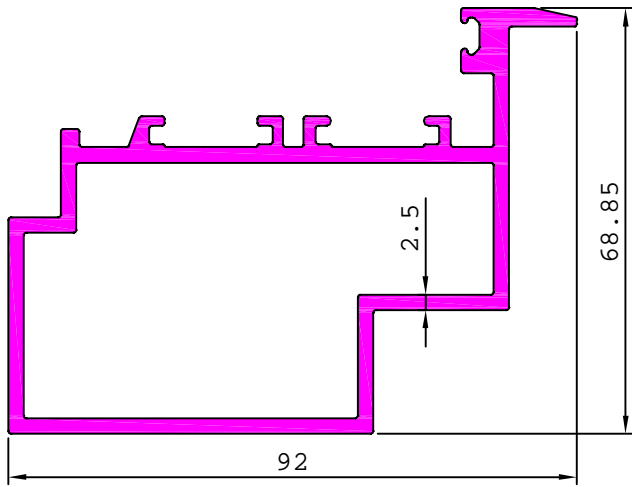

36206 2.590 kg/m

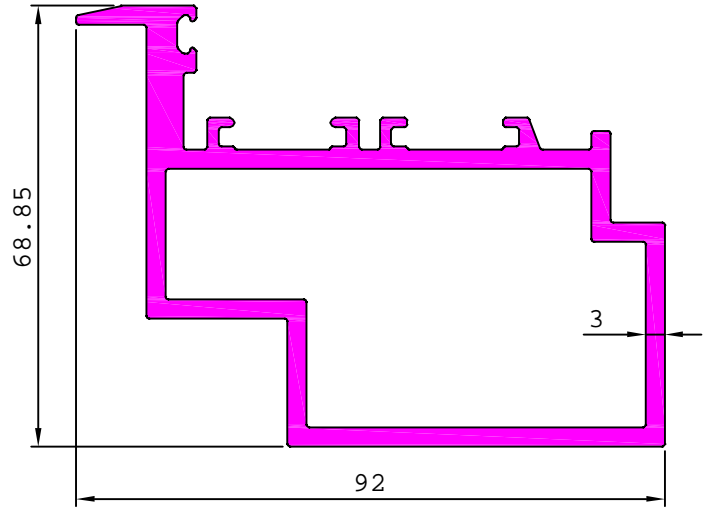

36203 2.302 kg/m

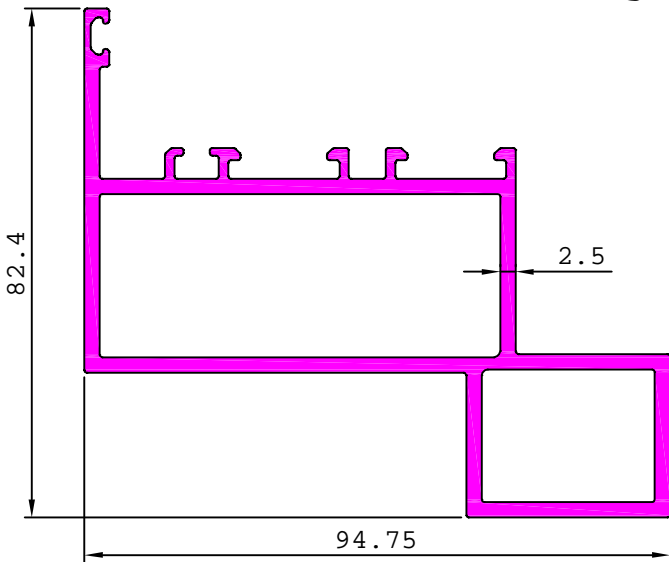

36207 2.550 kg/m

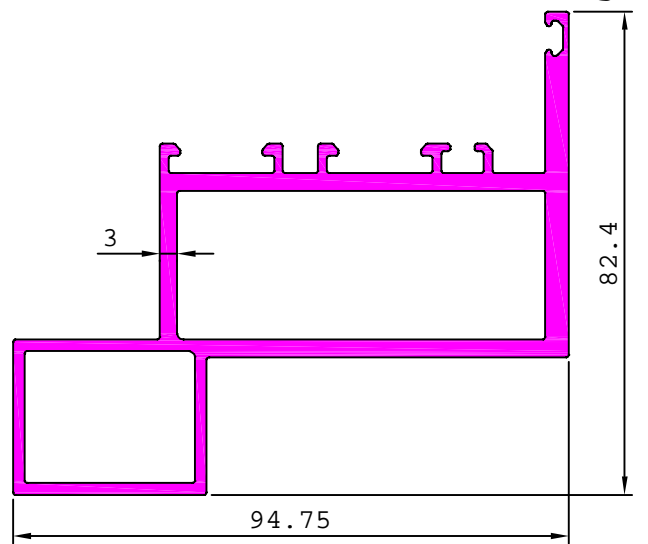

## CURTAIN WALL SECTION-T

36197

1.681 kg/m

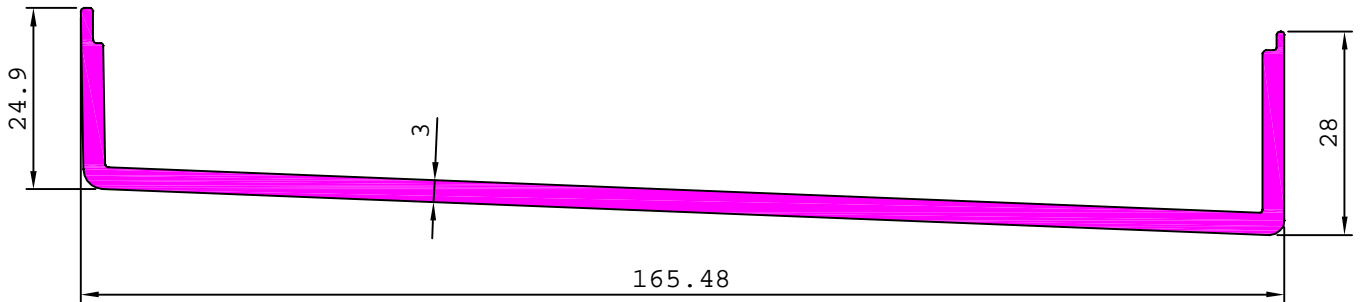

36196

2.580 kg/m

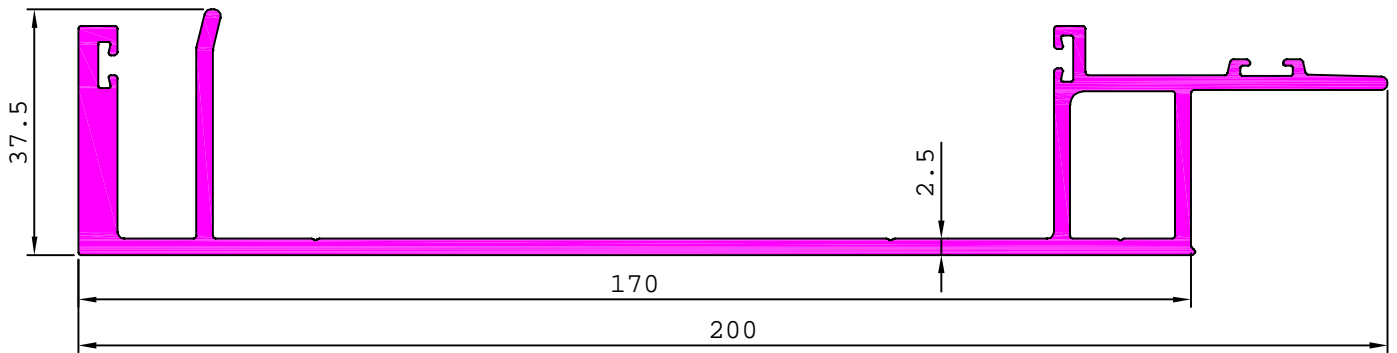

36199

2.431 kg/m

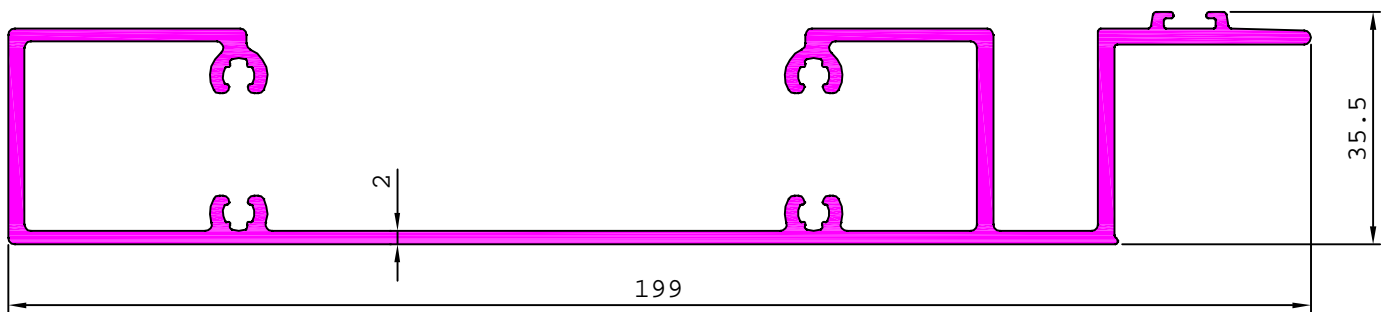

36201

0.343 kg/m

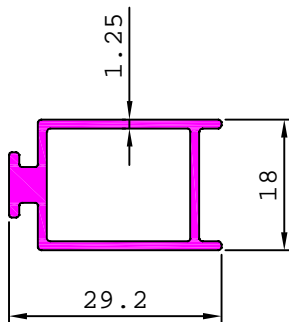

MATCHING WITH 36200

36202

0.406 kg/m

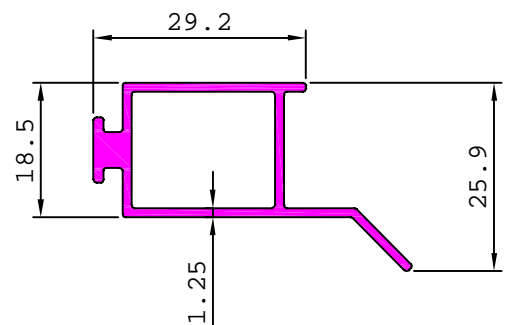

MATCHING WITH 36200

### CURTAIN WALL SECTION-T

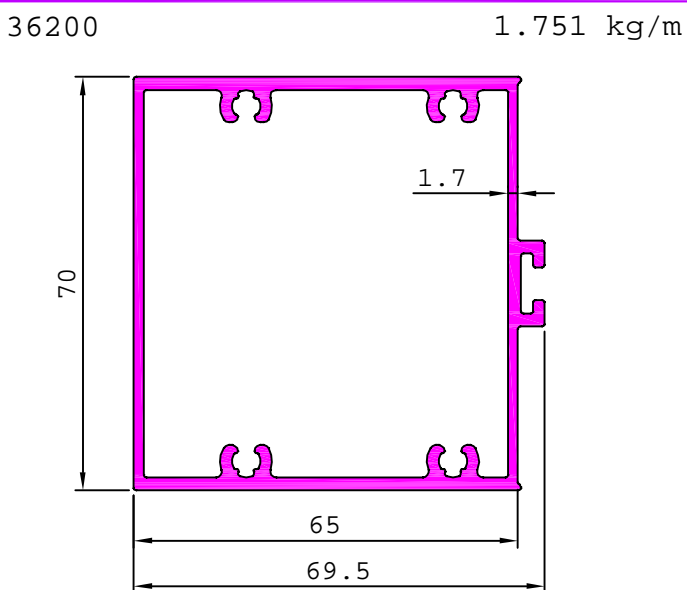
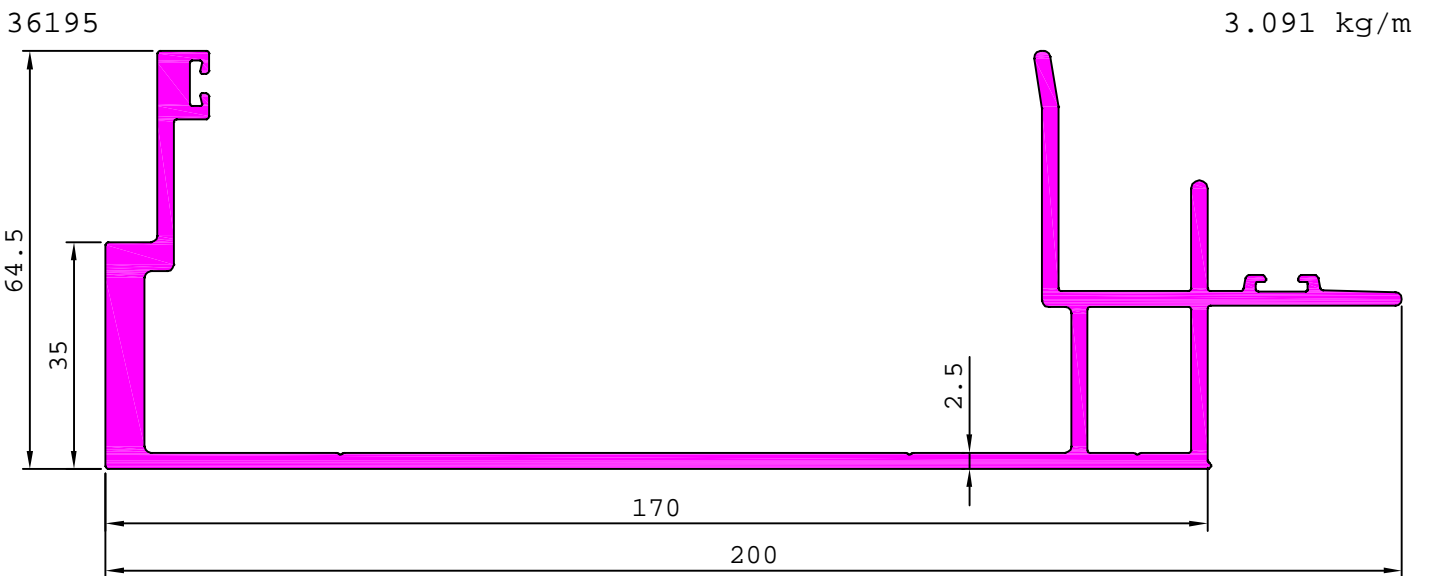
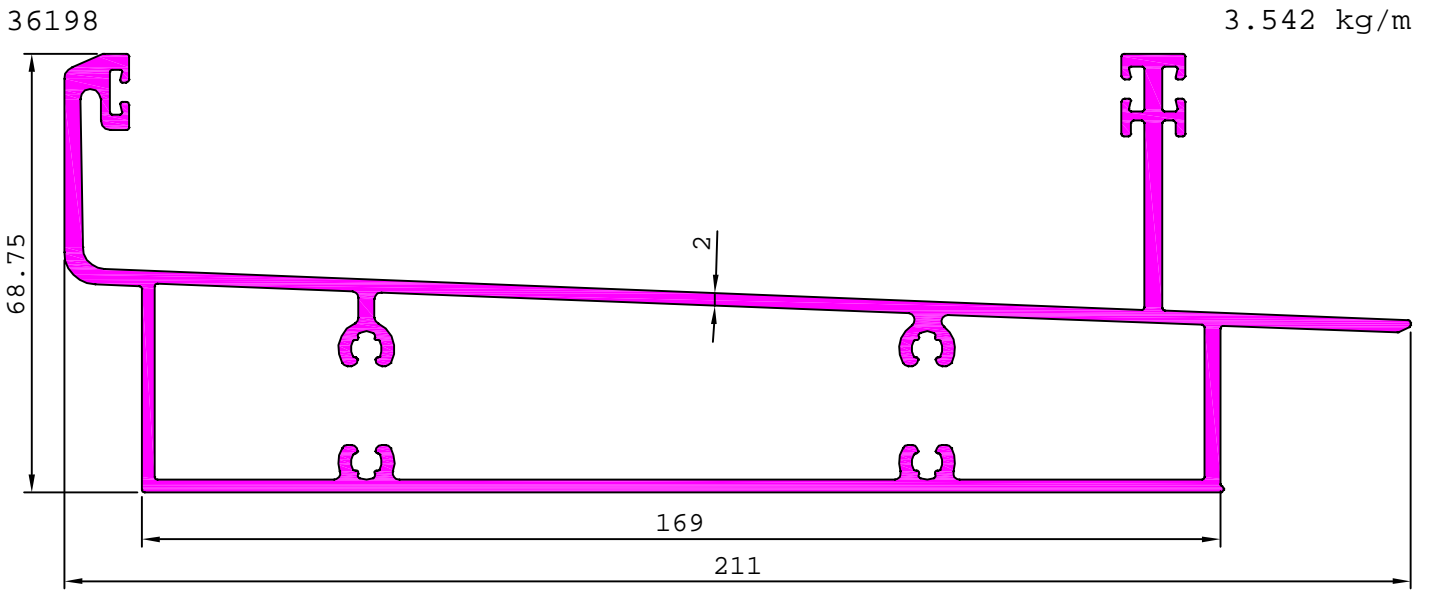

## CURTAIN WALL SECTION-U

36269

3.107 kg/m

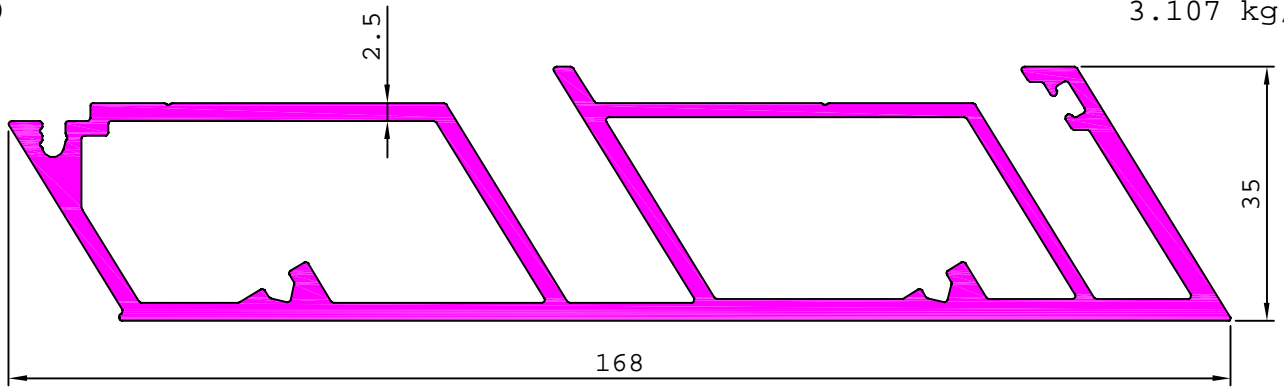

36272

2.728 kg/m

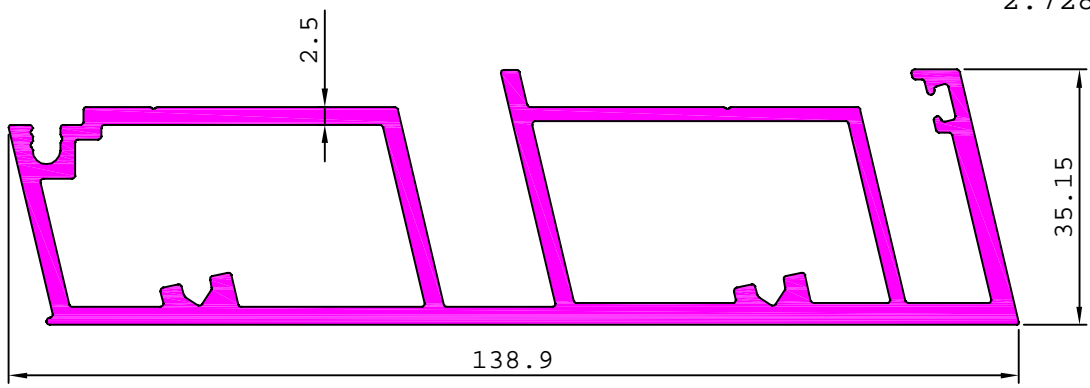

36274

2.777 kg/m

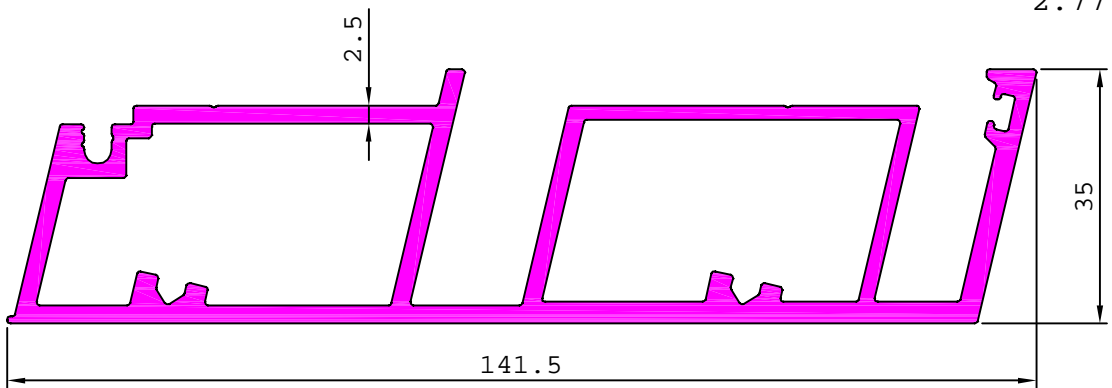

36271

3.074 kg/m

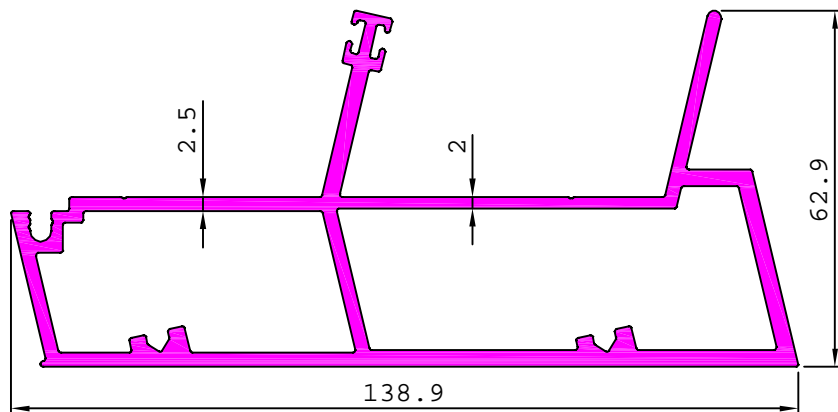

## CURTAIN WALL SECTION-U

36270

3.484 kg/m

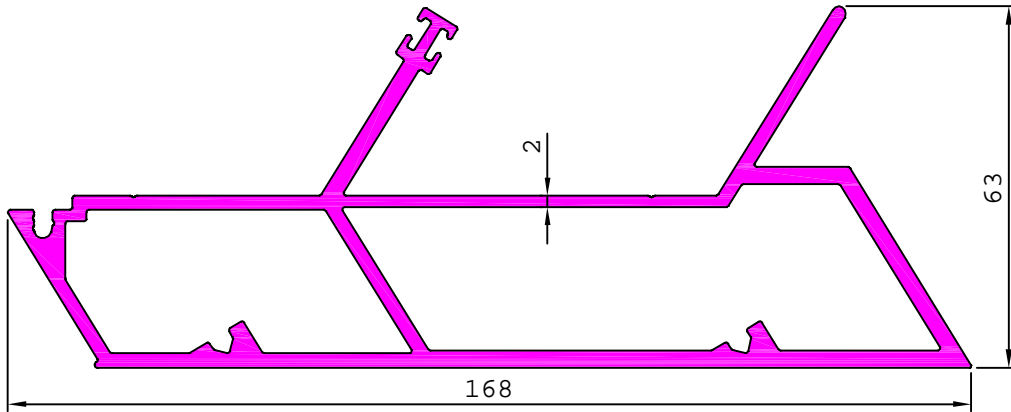

36273

3.116 kg/m

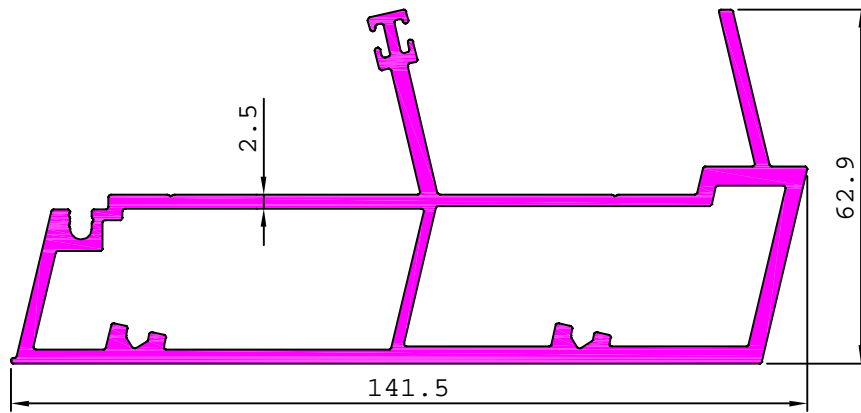

29100

1.553 kg/m

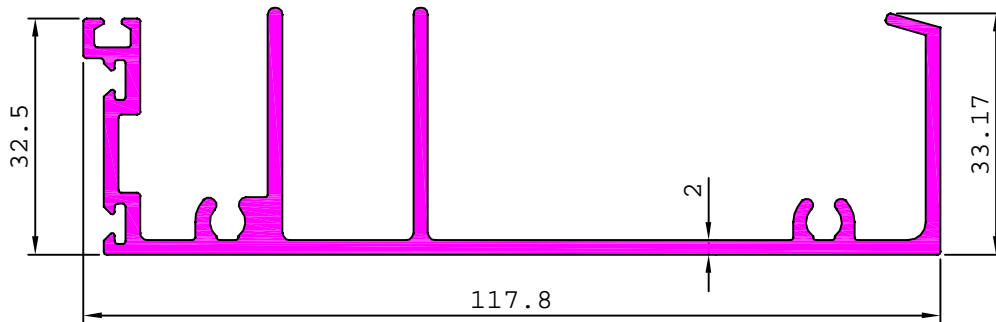

## CURTAIN WALL SECTION-U

36015

1.432 kg/m

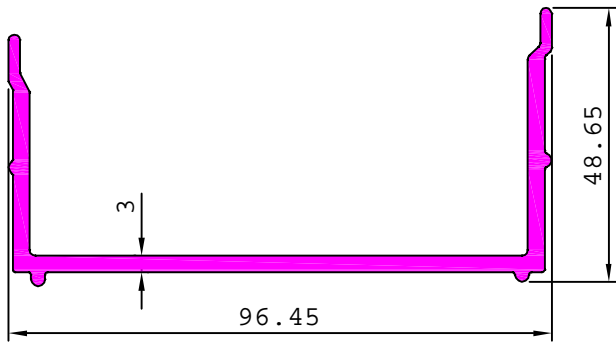

36010

0.192 kg/m

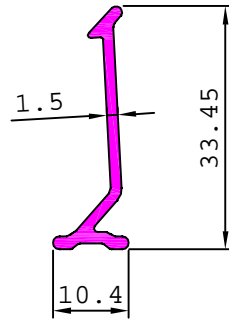

36209

1.045 kg/m

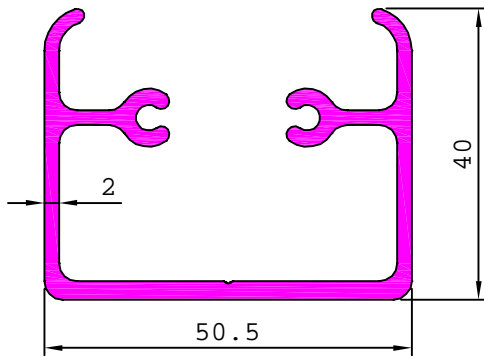

36208

0.238 kg/m

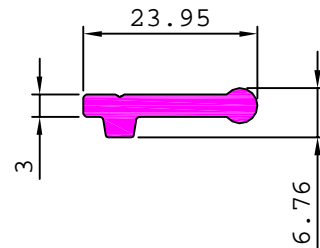

36016

2.344 kg/m

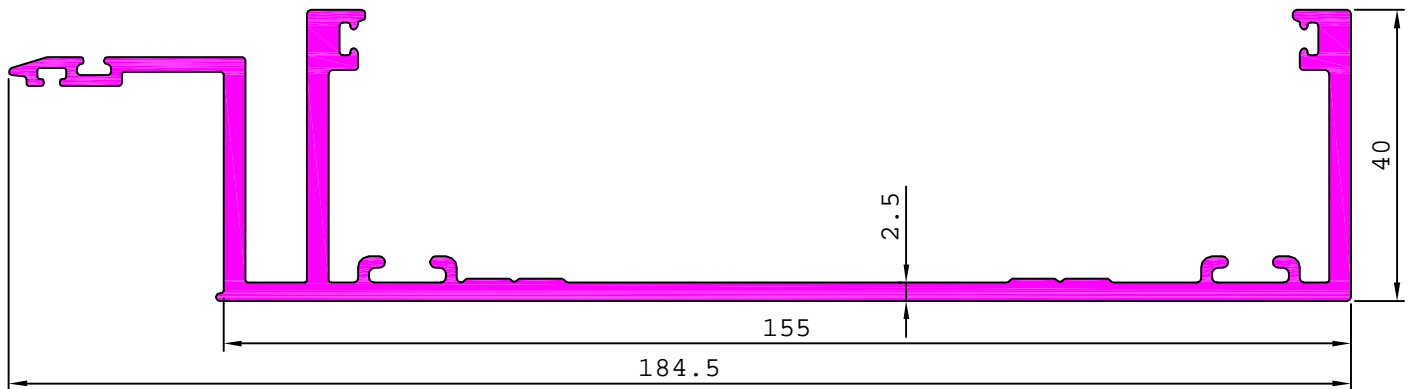

36013

3.380 kg/m

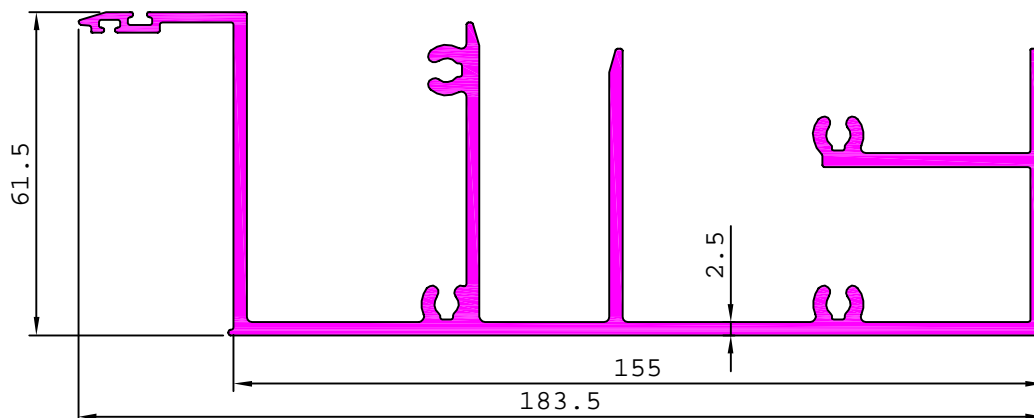

### CURTAIN WALL SECTION-U

36012

2.739 kg/m

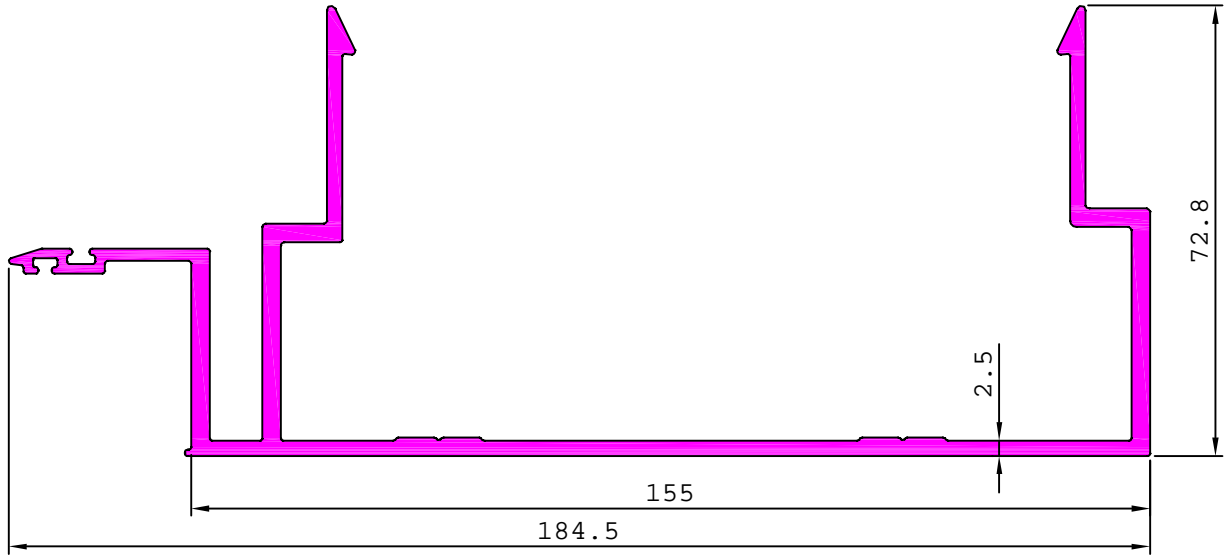

36014

4.578 kg/m

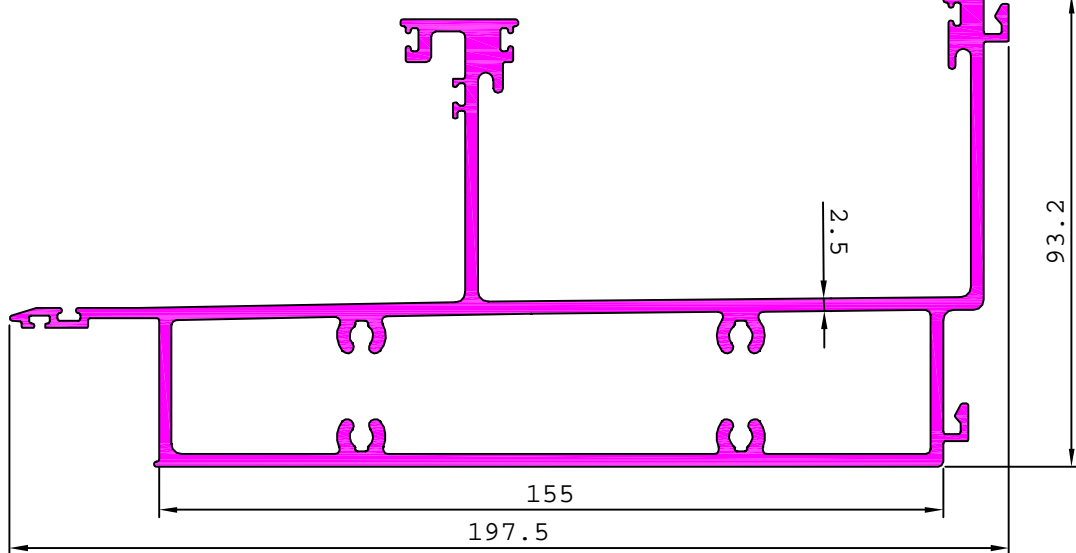

36011

3.993 kg/m

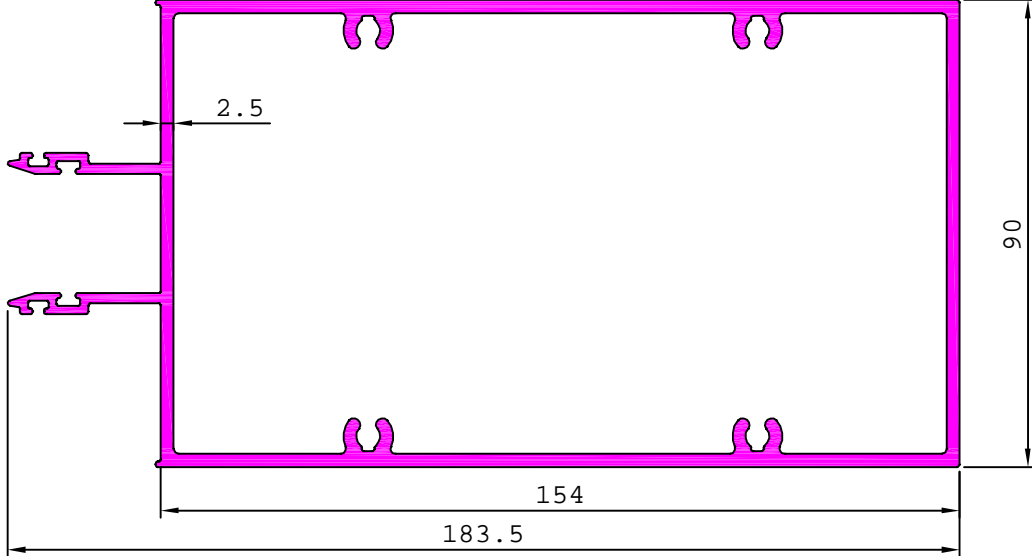

## CURTAIN WALL SECTION-V

36072

1.407 kg/m

36073

0.282 kg/m

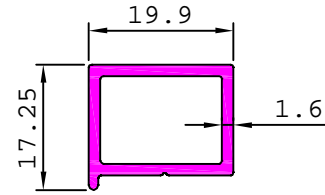
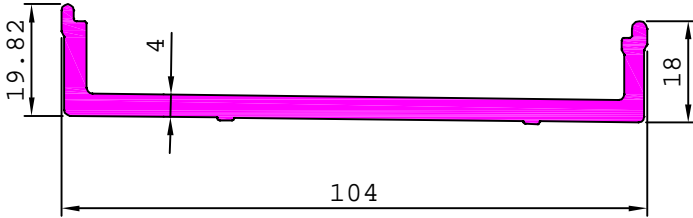

36074

0.834 kg/m

36075

1.431 kg/m

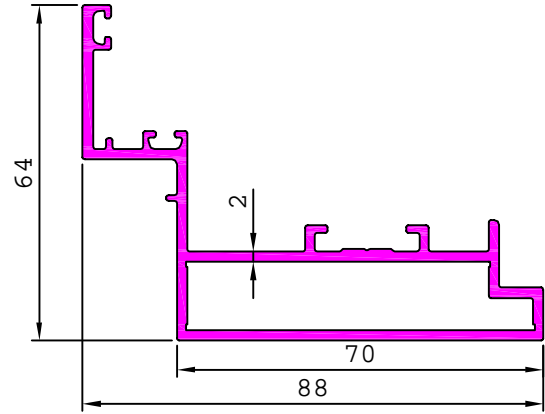
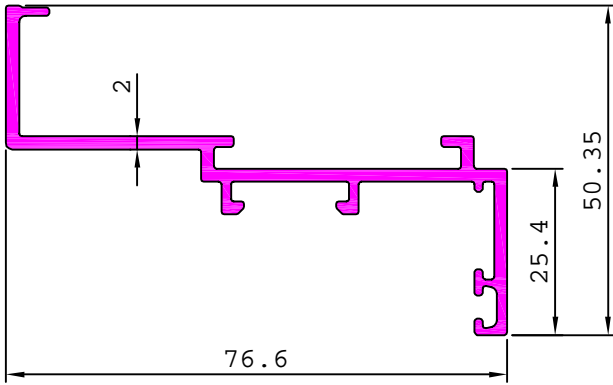

36071

2.590 kg/m

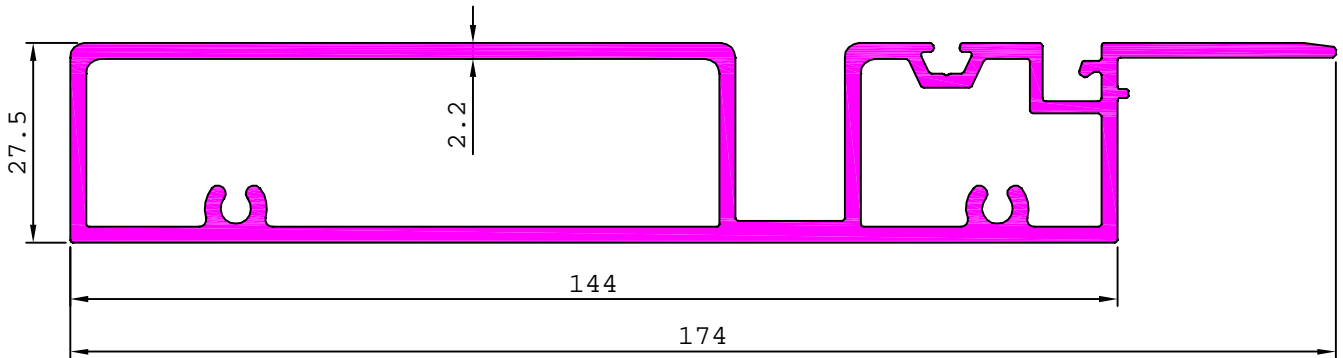

36068

1.816 kg/m

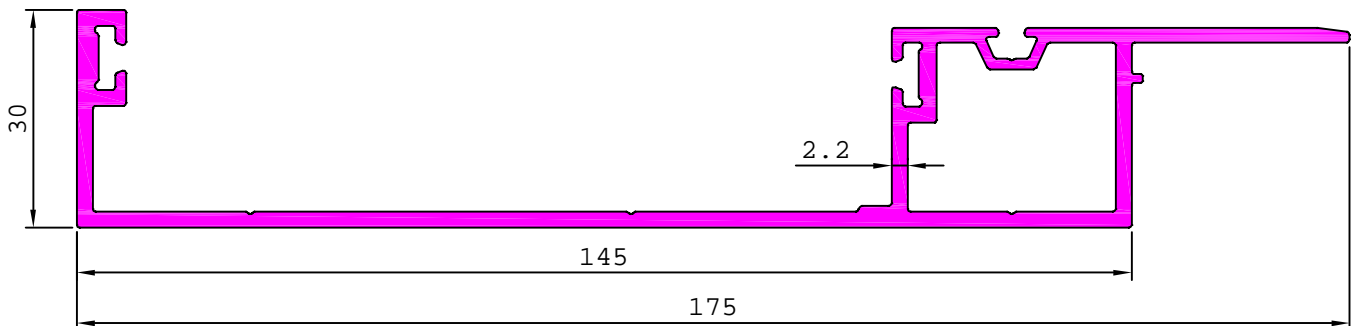

## CURTAIN WALL SECTION-V

G100644

2.170 kg/m

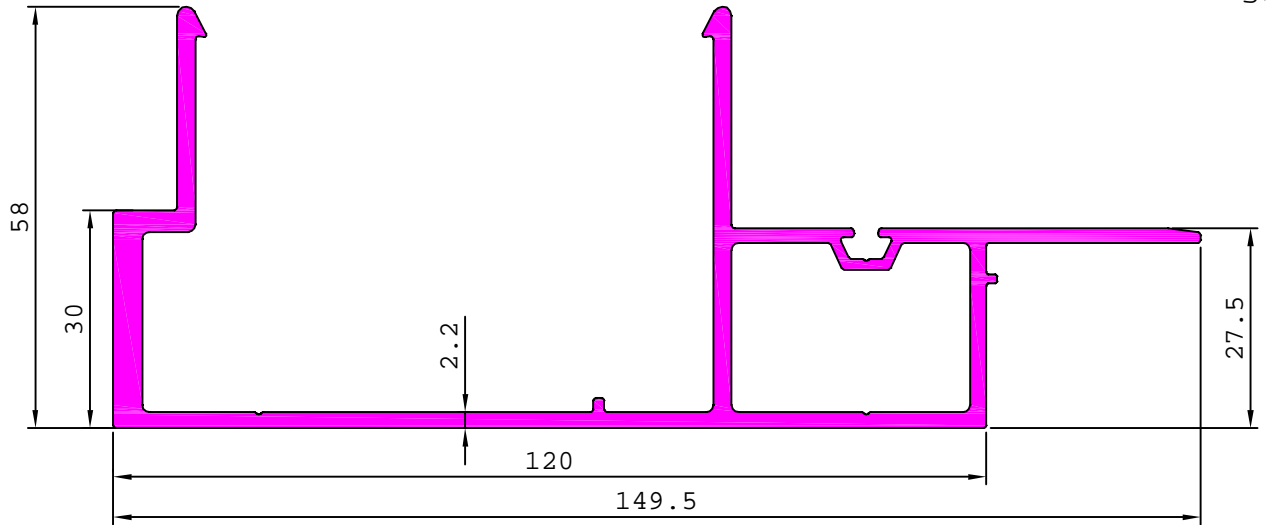

MATCHING WITH G100646

G100646

1.690 kg/m

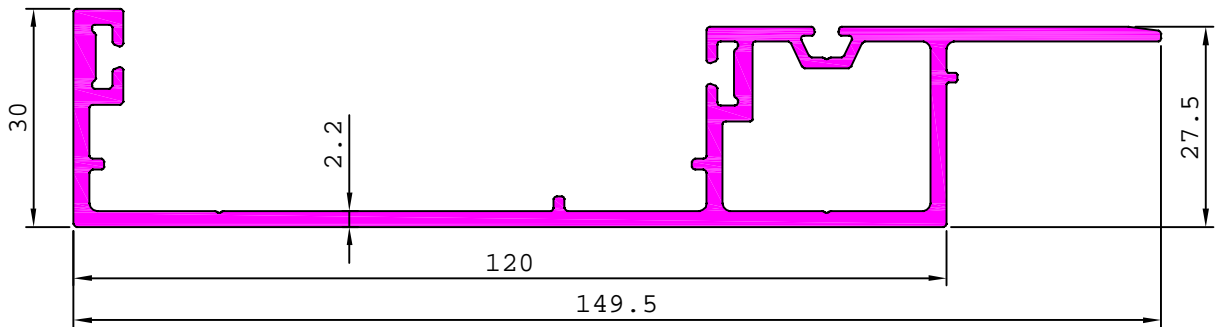

MATCHING WITH G100644

G101212

2.487 kg/m

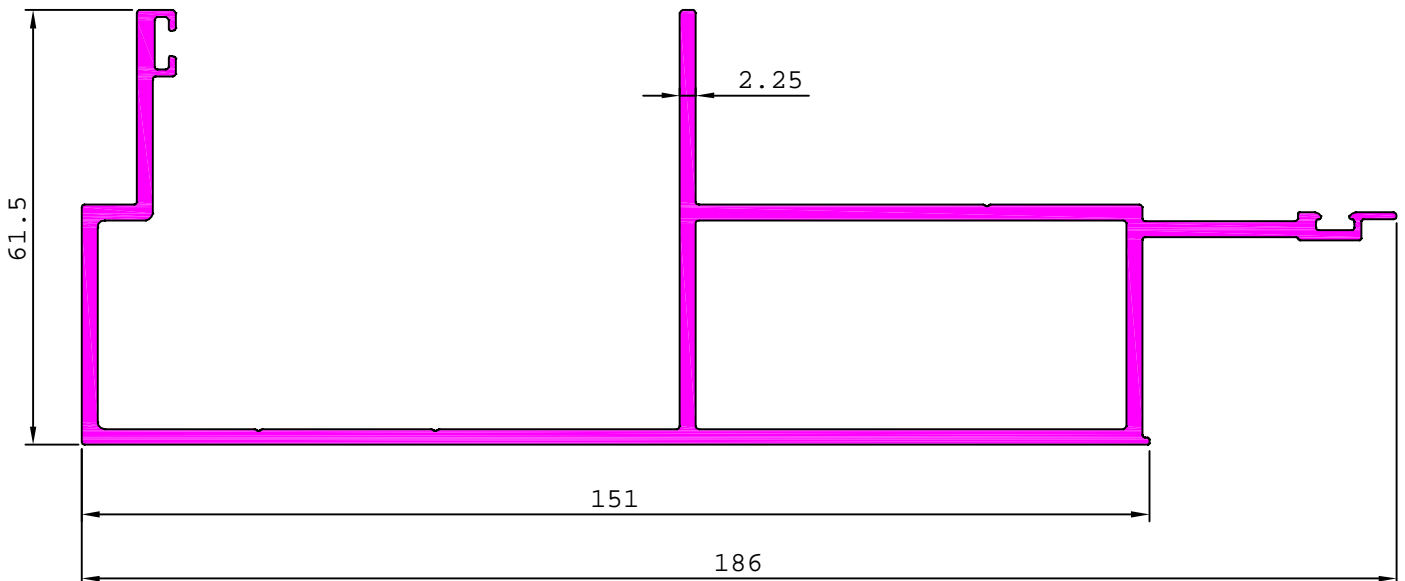

# CURTAIN WALL SECTION-W

36067

2.318 kg/m

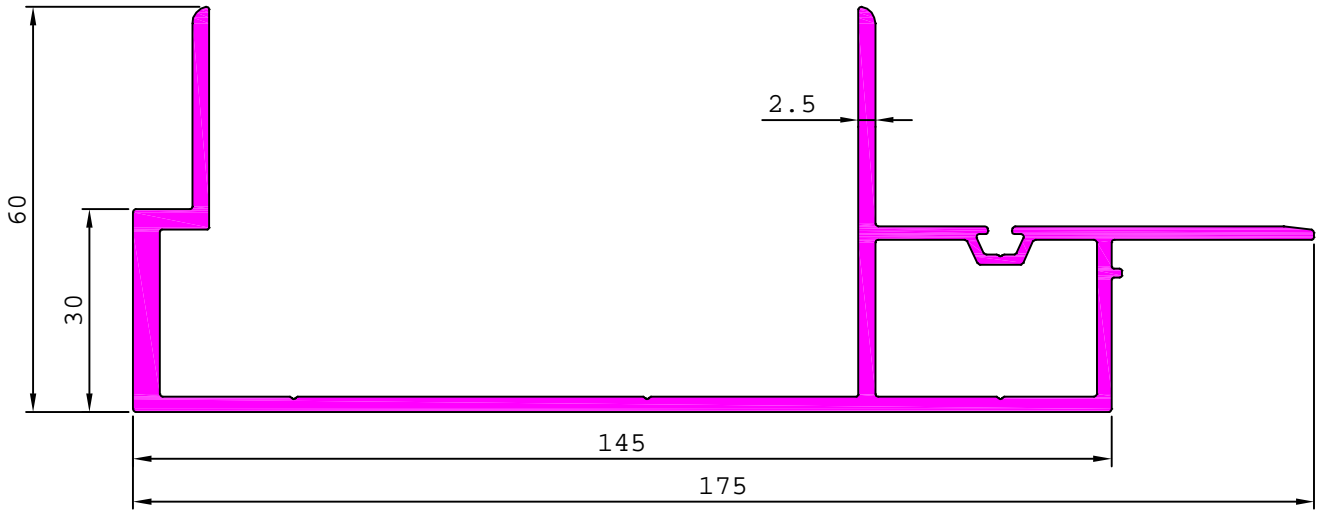

36070

3.209 kg/m

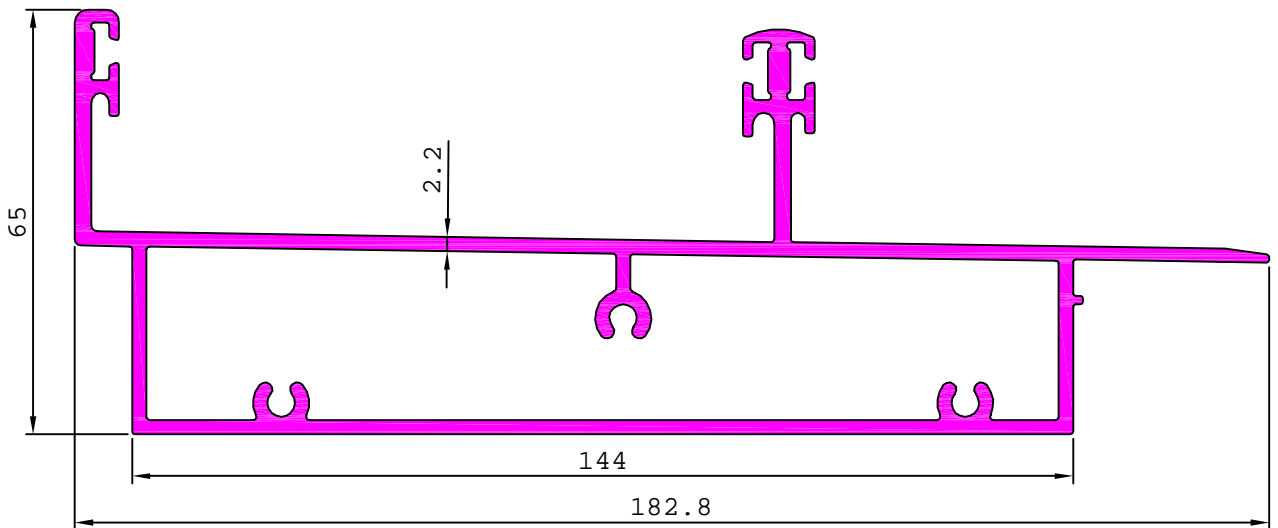

36069

3.112 kg/m

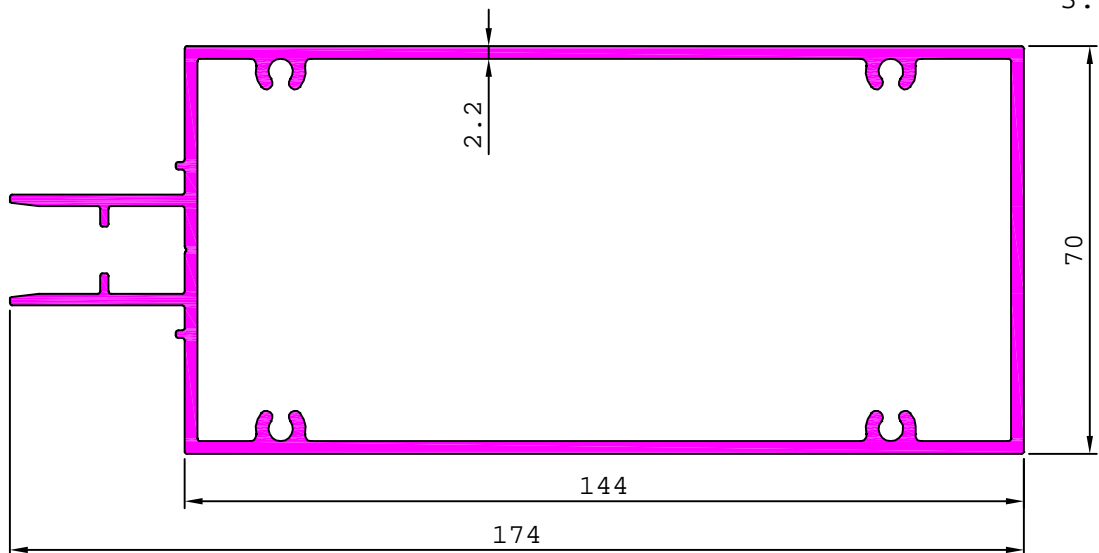

# CURTAIN WALL SECTION-W

G101104

2.225 kg/m

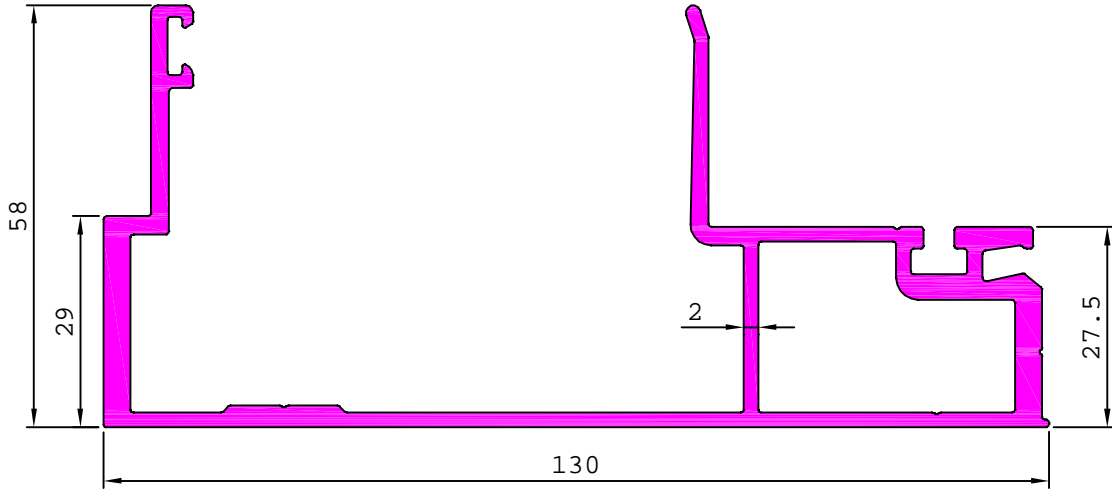

MATCHING WITH G101105

G101105

1.895 kg/m

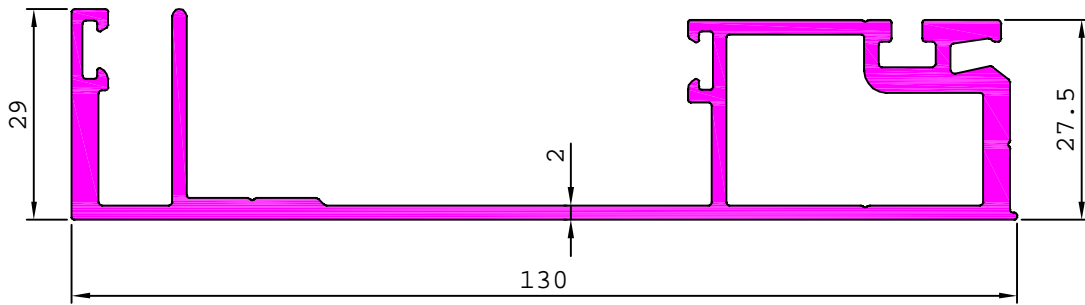

MATCHING WITH G101104

G101394

2.020 kg/m

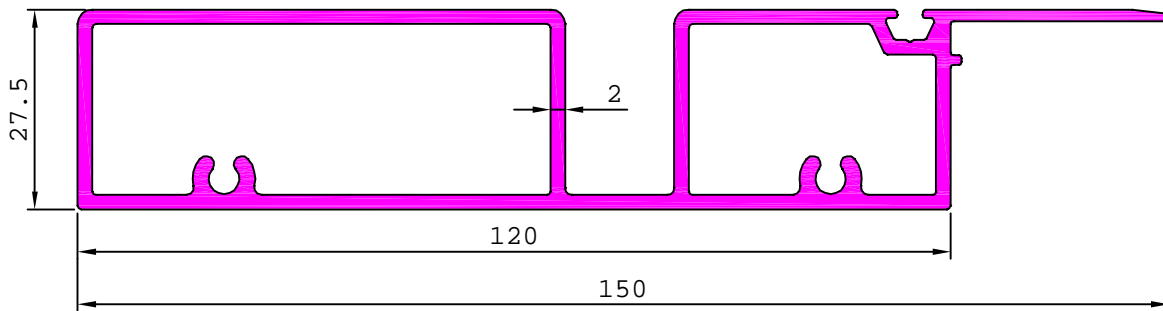

G101098

0.242 kg/m

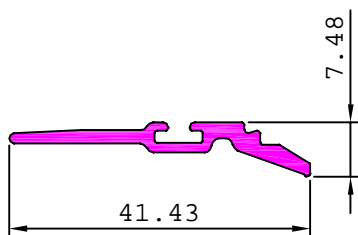

MATCHING WITH G101104,G101105

## CURTAIN WALL SECTION-W

G101391

2.796 kg/m

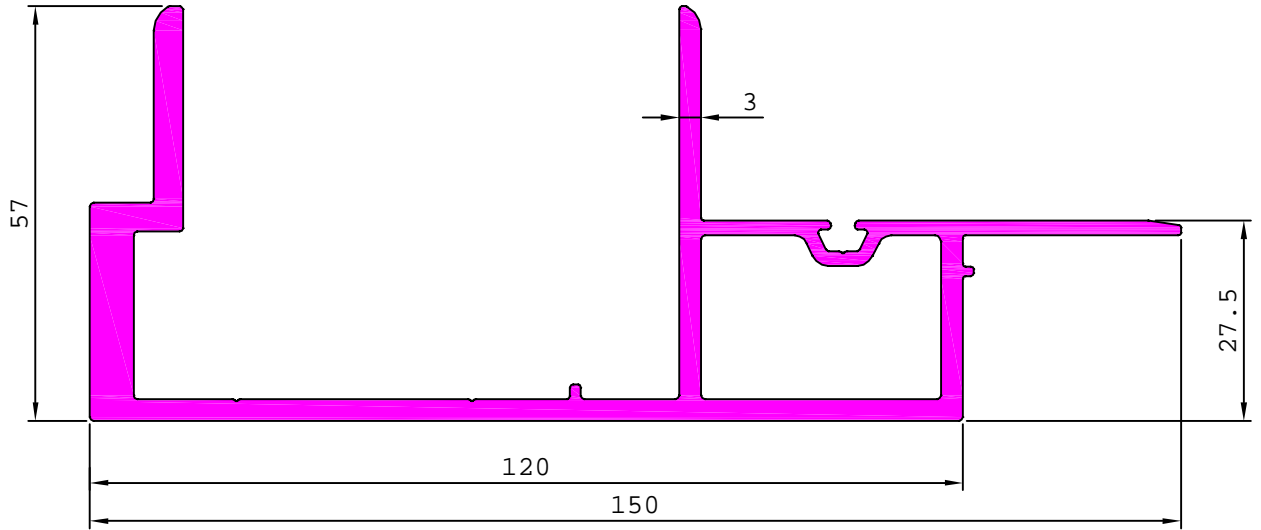

MATCHING WITH G101392

G101392

2.045 kg/m

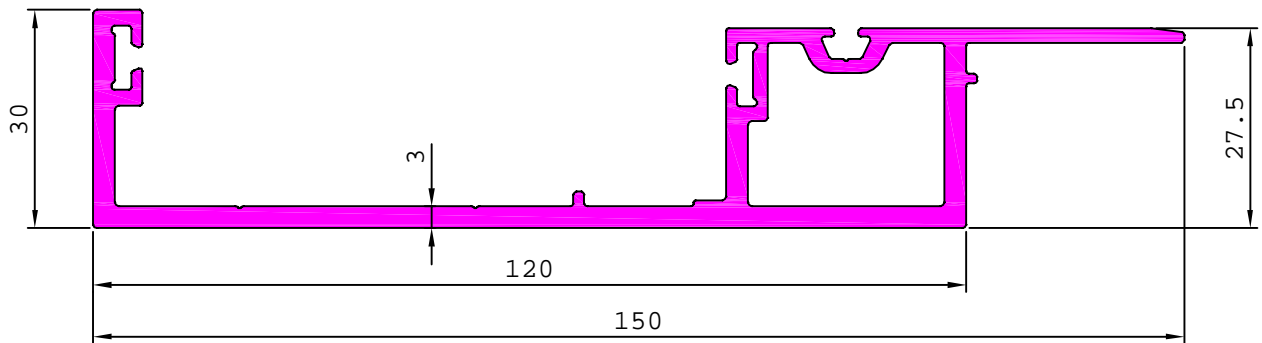

MATCHING WITH G101391

G101432

2.852 kg/m

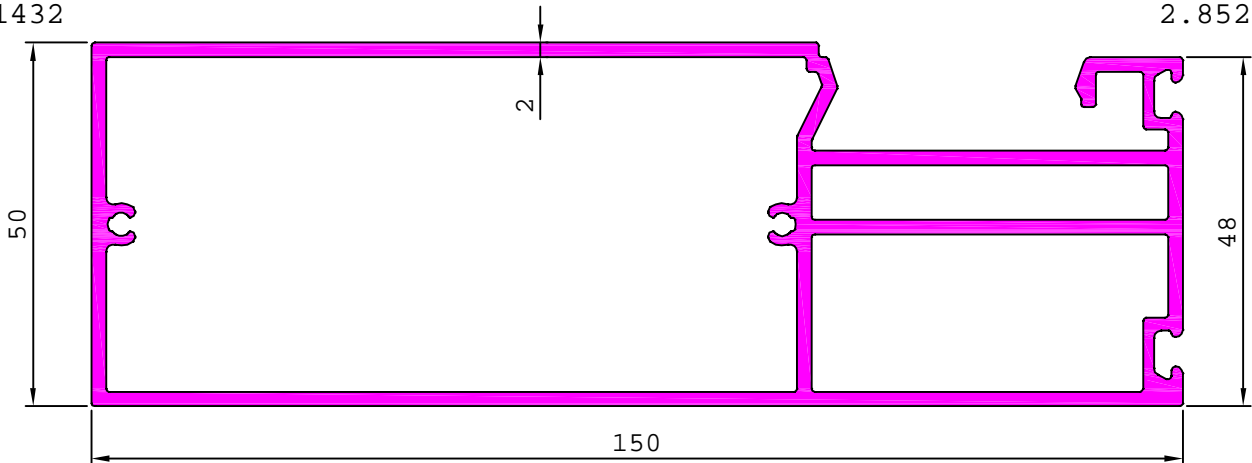

MATCHING WITH G101439

### CURTAIN WALL SECTION-W

29101

2.750 kg/m

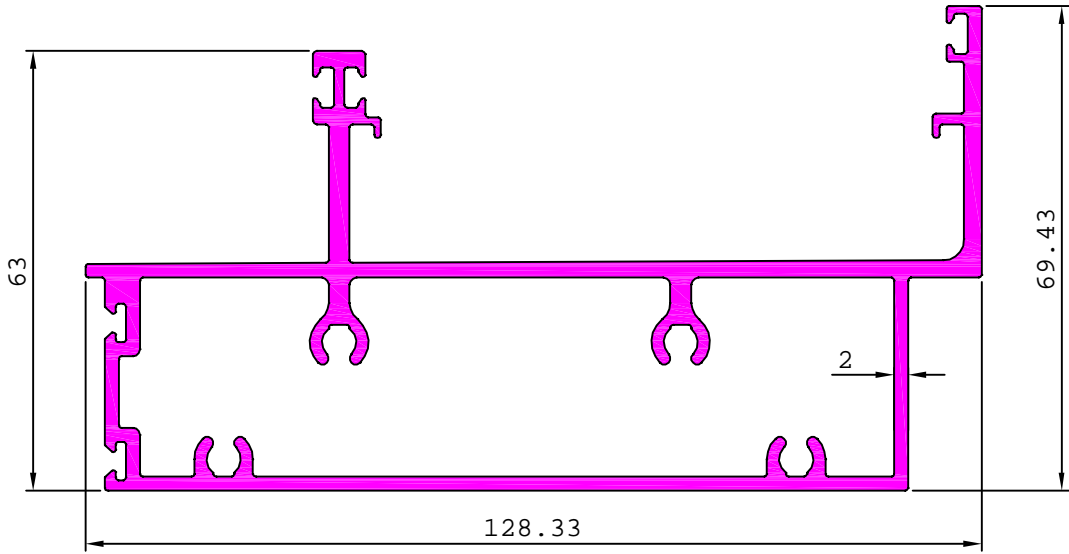

29097

2.242 kg/m

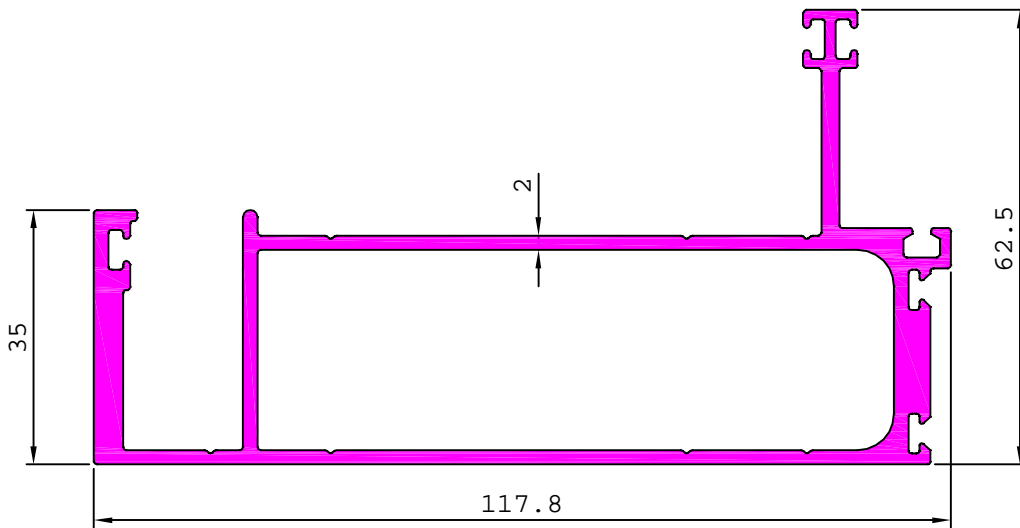

29098

2.241 kg/m

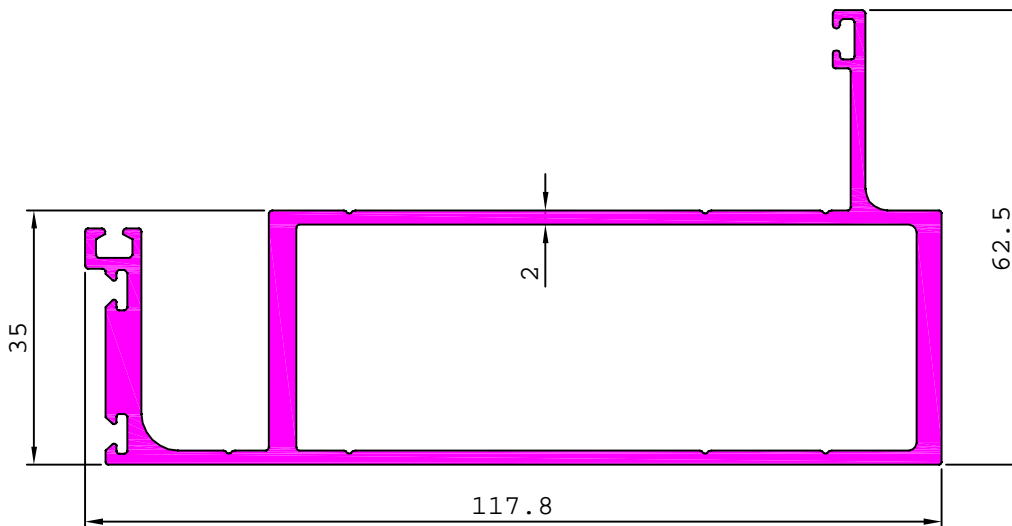

### CURTAIN WALL SECTION-X

36292

2.507 kg/m

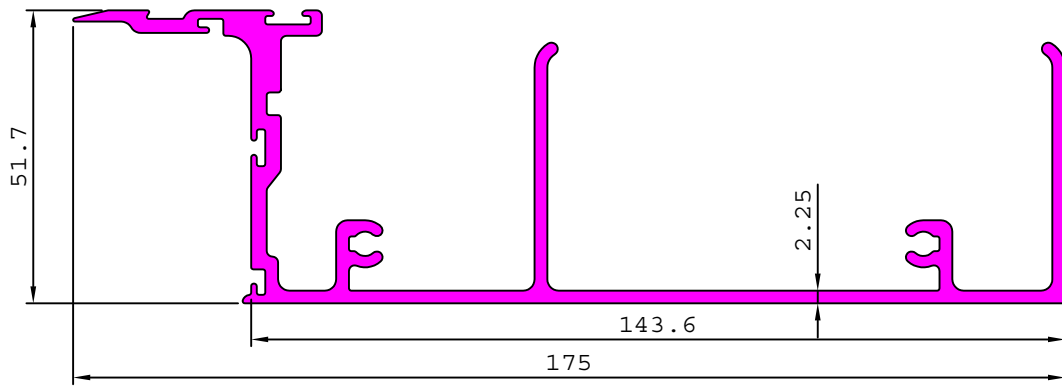

36291

1.416 kg/m

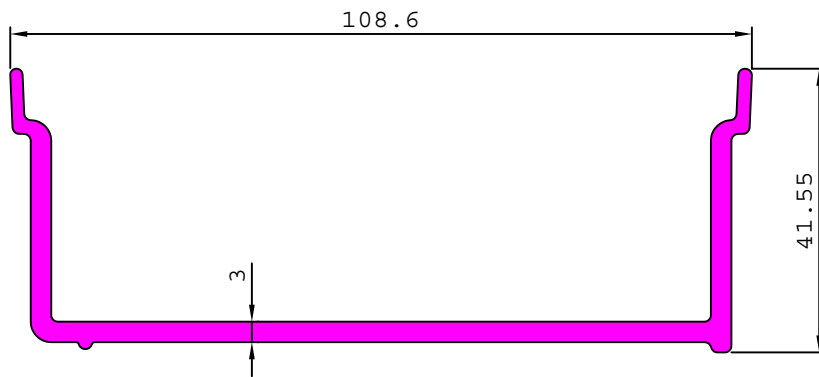

36289

3.287 kg/m

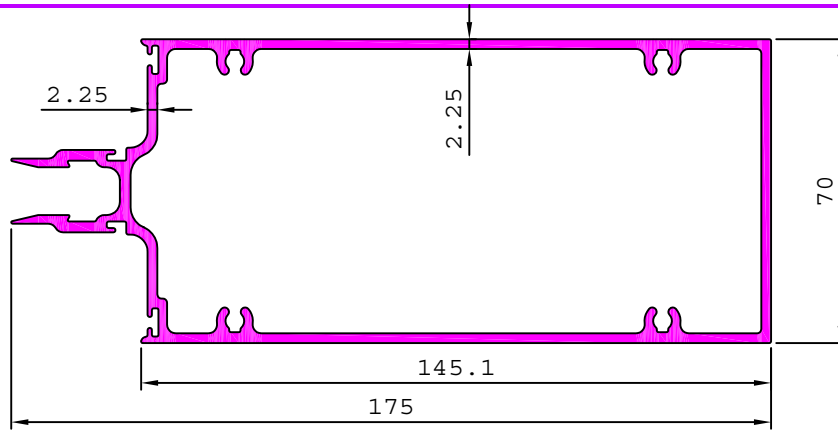

36287

2.395 kg/m

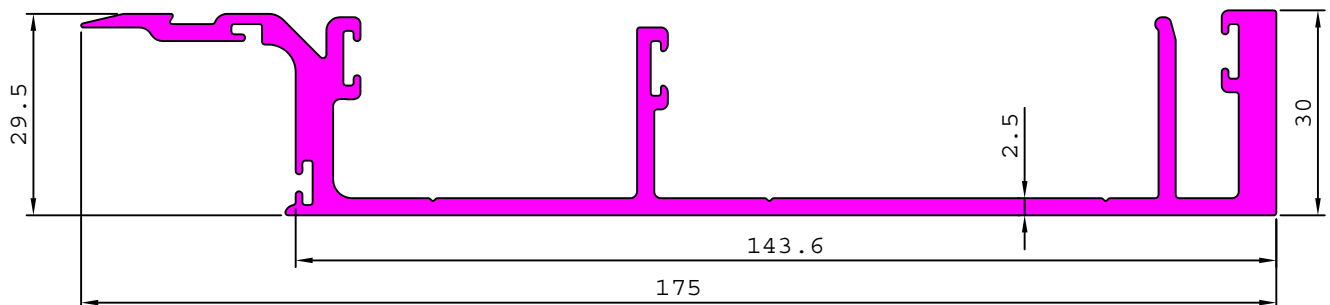

## CURTAIN WALL SECTION-X

36288

2.875 kg/m

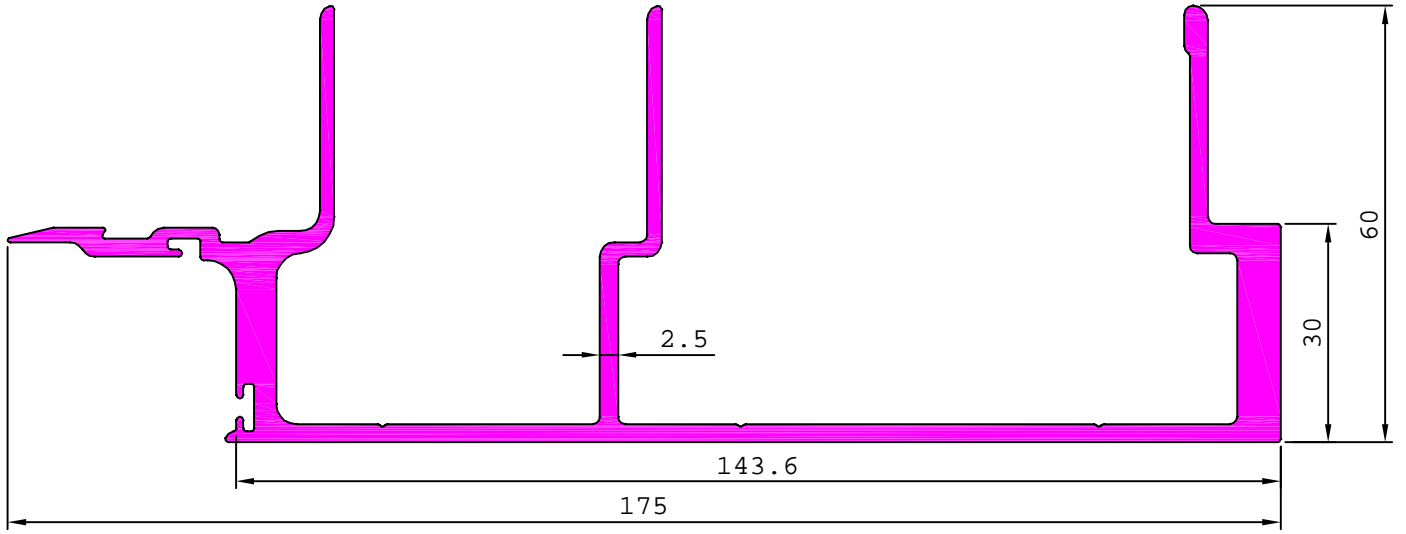

36290

3.758 kg/m

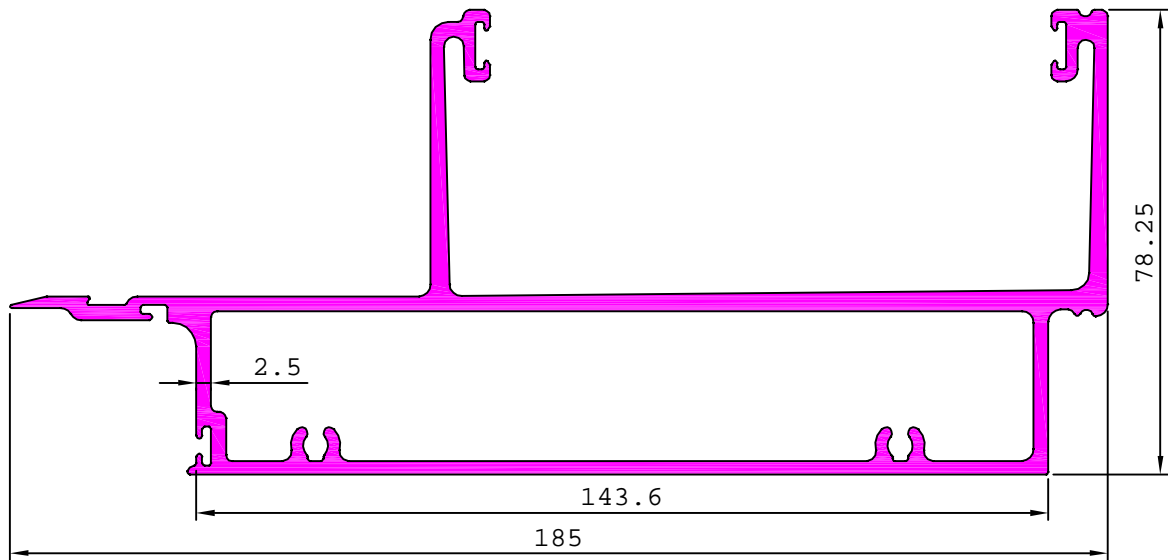

G101388

2.726 kg/m

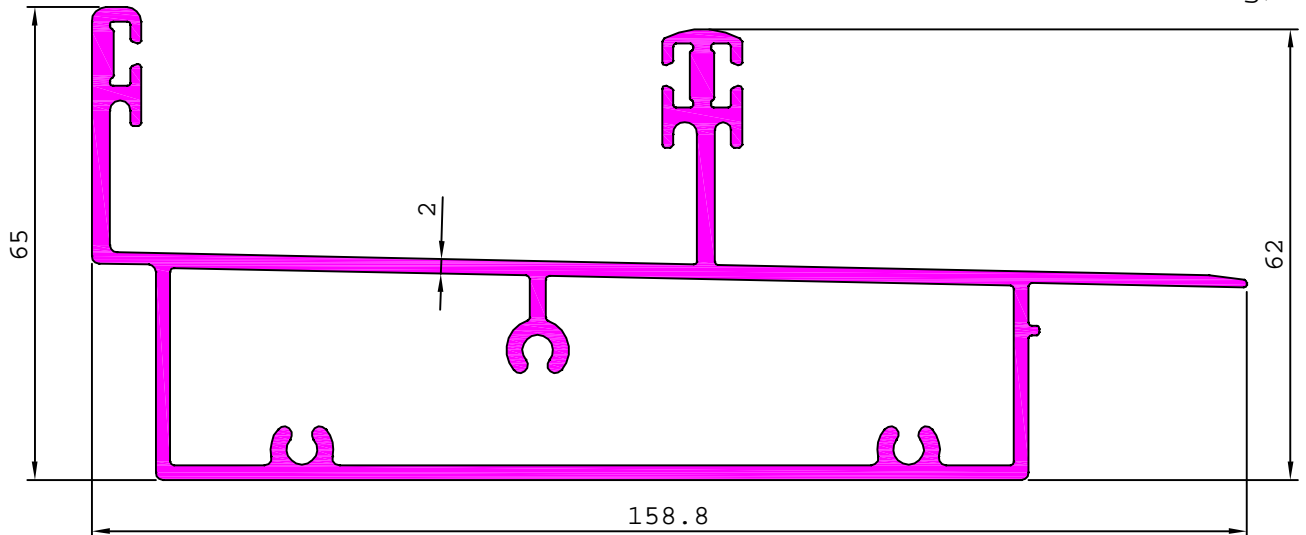

MATCHING WITH G101408

### CURTAIN WALL SECTION-Y

36325

3.740 kg/m

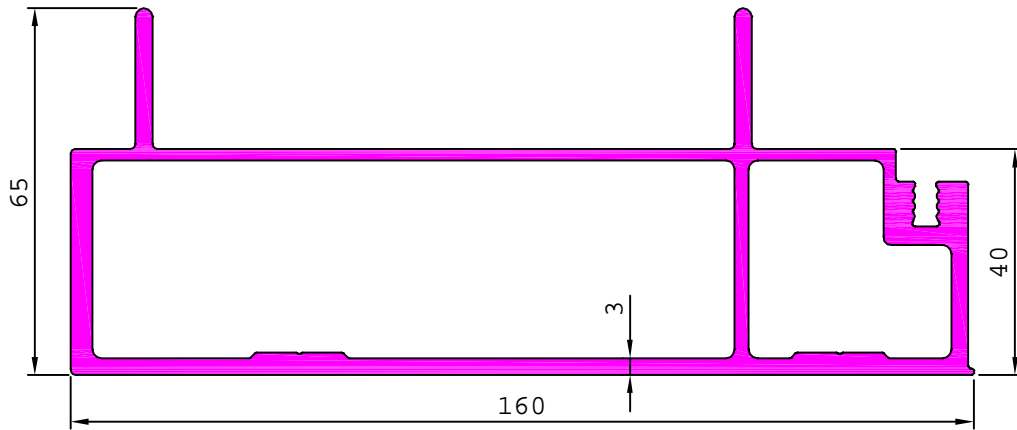

36326

3.703 kg/m

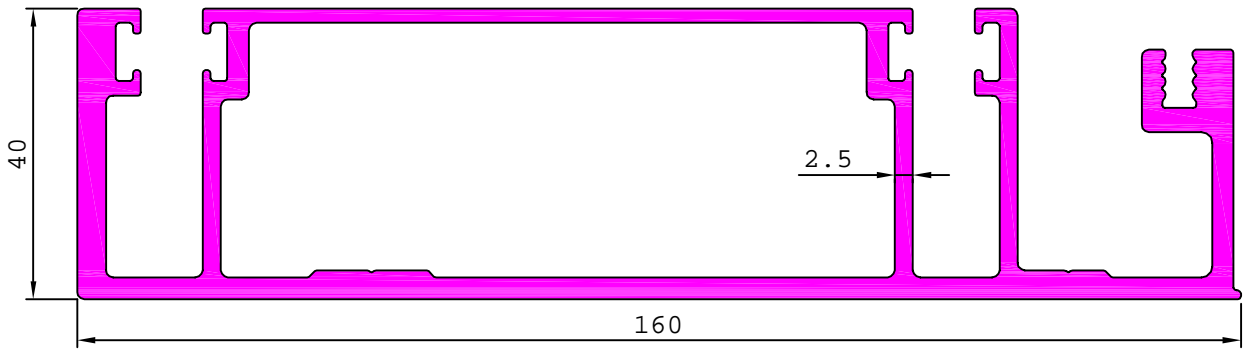

36327

2.897 kg/m

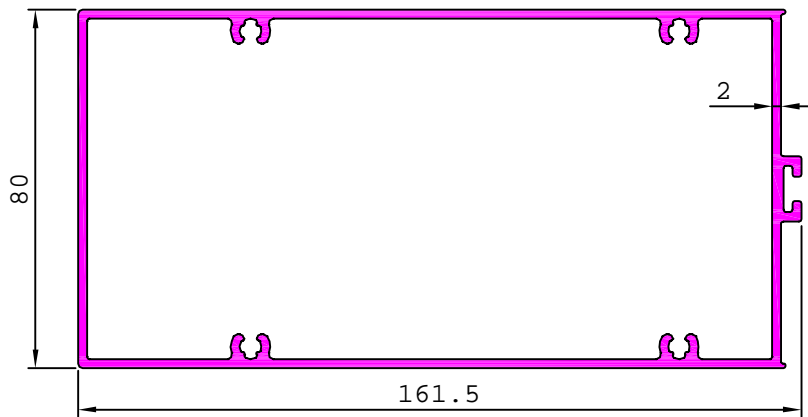

36328

2.793 kg/m

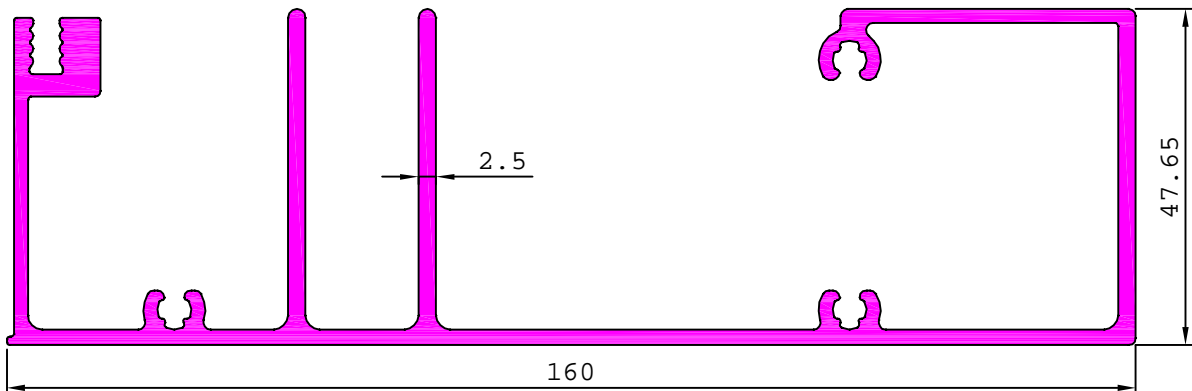

## CURTAIN WALL SECTION-Y

36329

3.404 kg/m

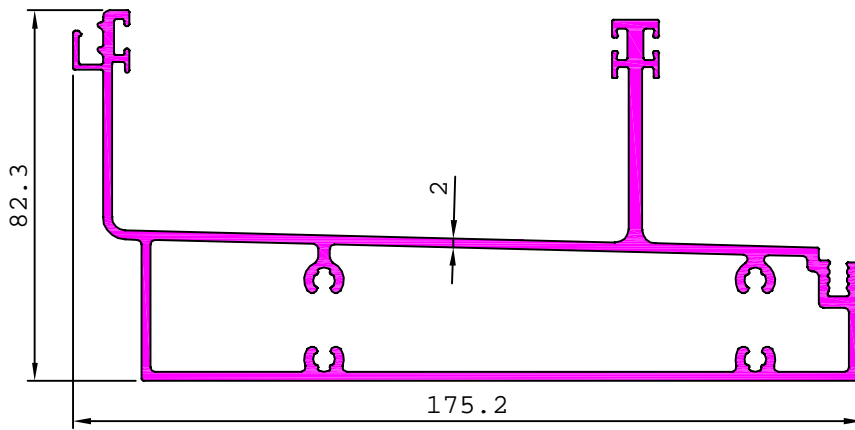

36330

1.815 kg/m

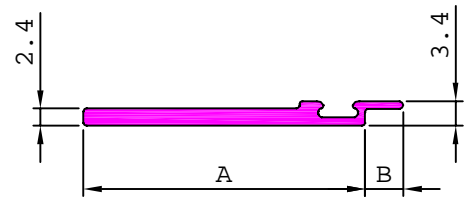
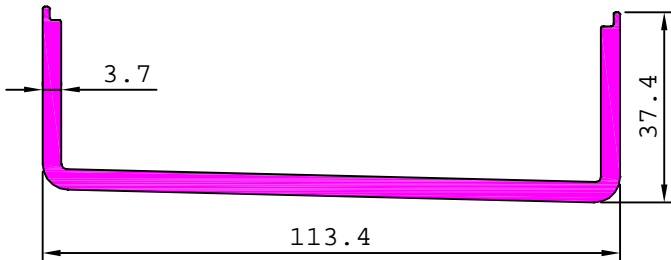

SL No	SECTION No	A	B	WEIGHT kg/m
1	<b>36331</b>	38.70	5.30	0.261
2	<b>36335</b>	48.20	10.25	0.338

36332

3.056 kg/m

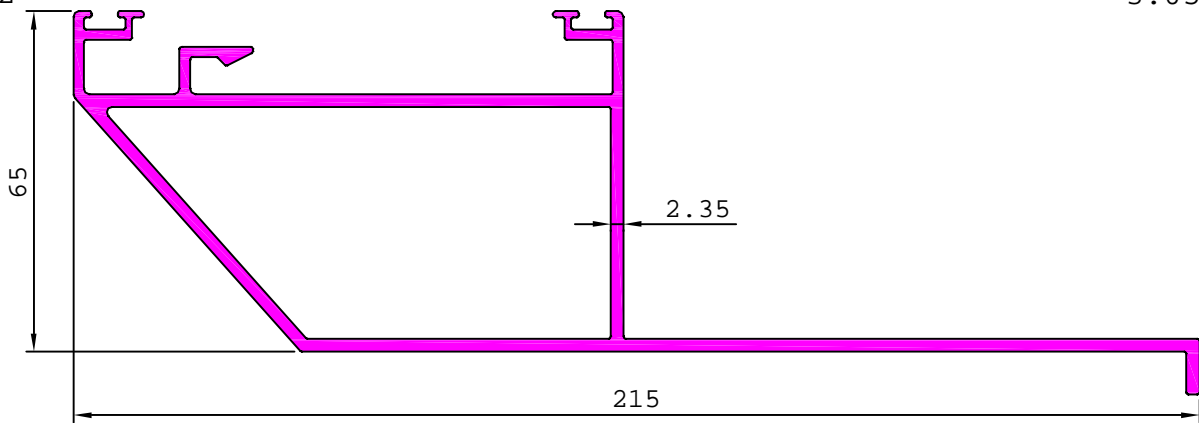

36333

5.783 kg/m

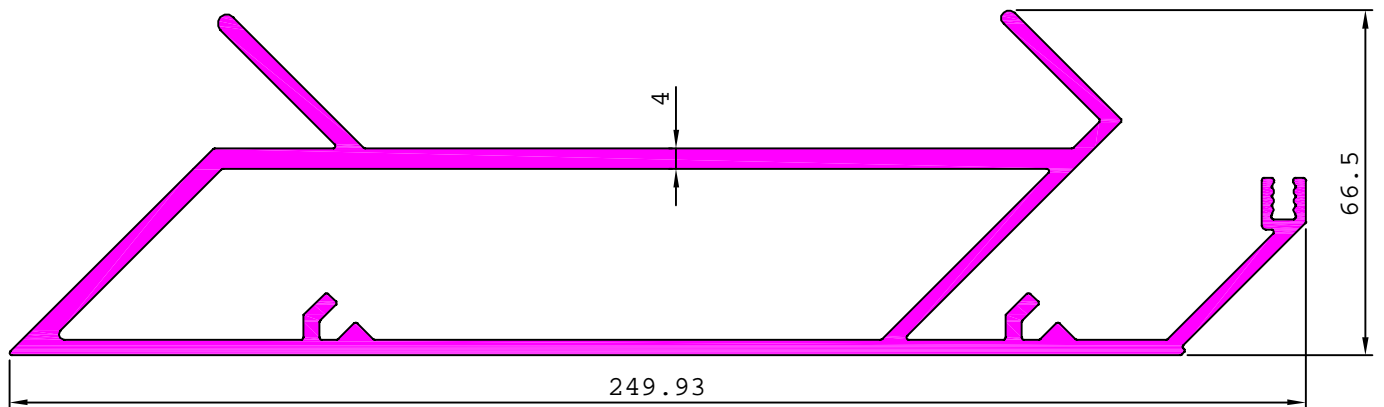

## CURTAIN WALL SECTION-Z

36334

5.319 kg/m

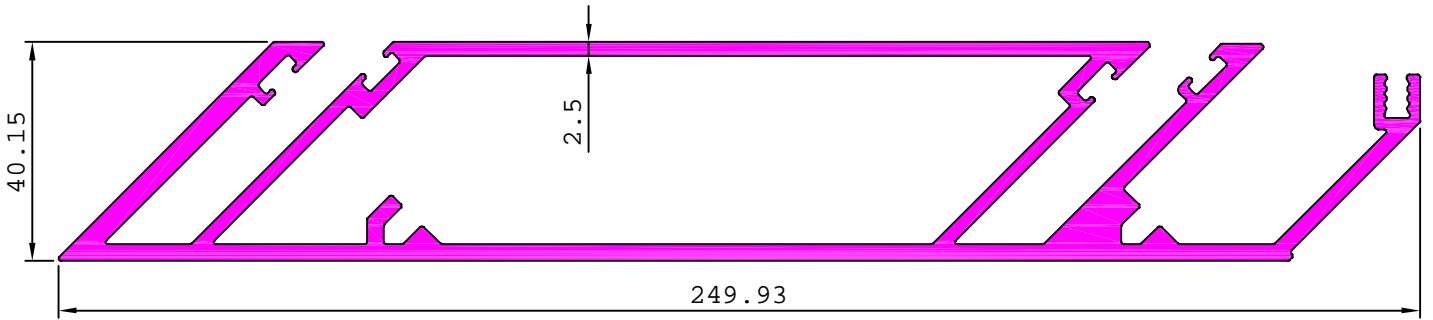

36420

5.600 kg/m

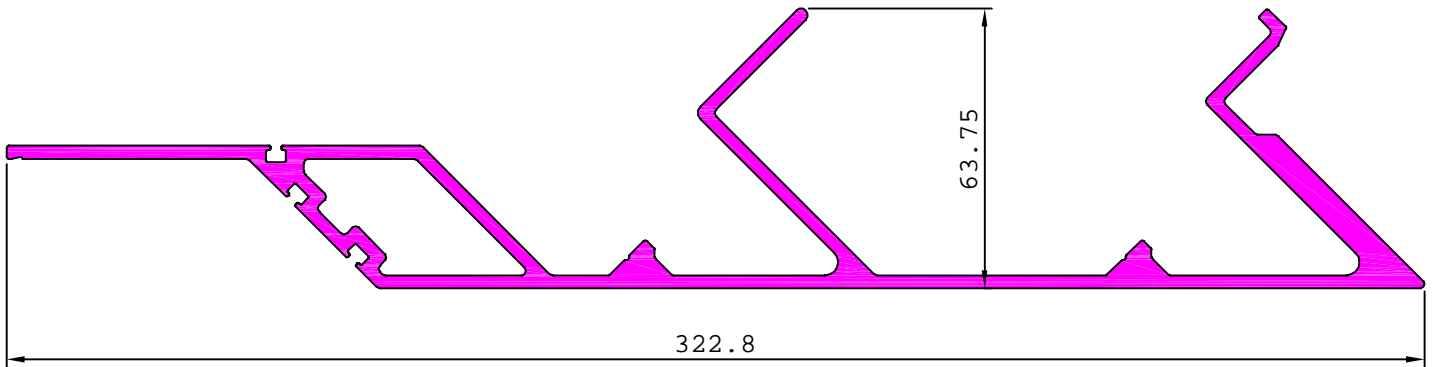

36416

1.571 kg/m

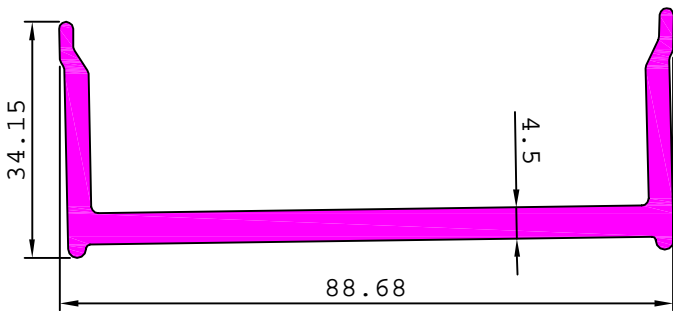

29102

1.215 kg/m

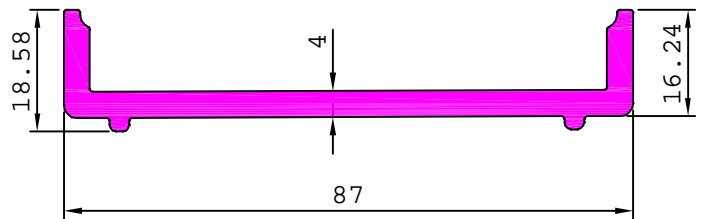

### CURTAIN WALL SECTION-Z

36376

3.730 kg/m

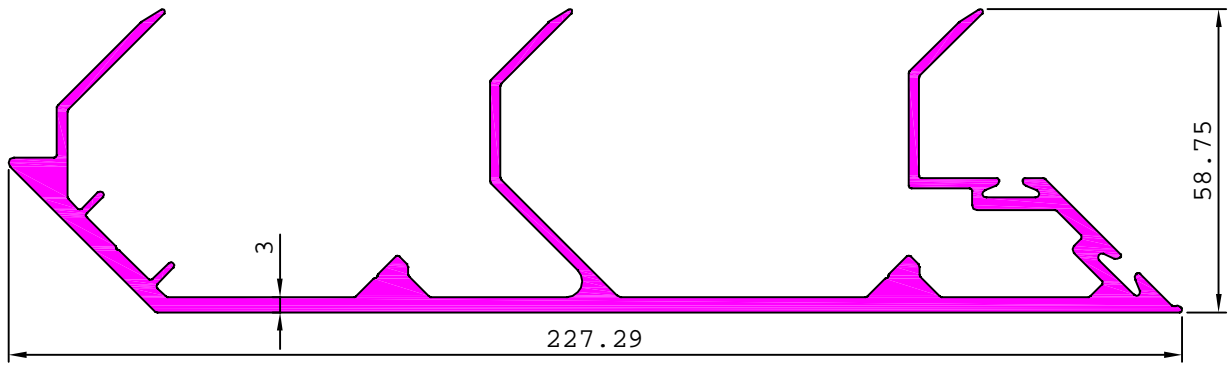

36377

3.393 kg/m

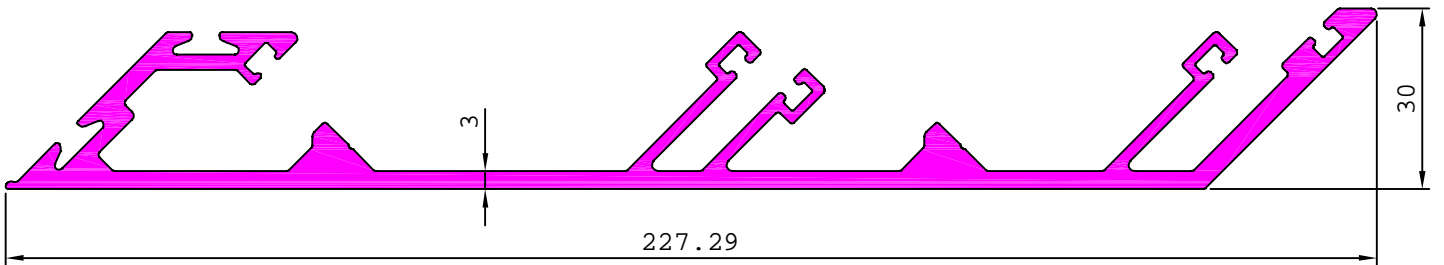

36381

2.927 kg/m

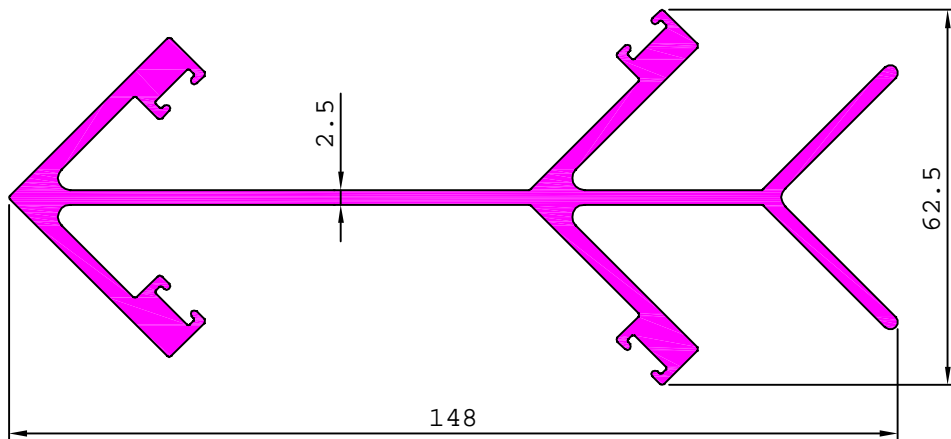

36382

4.198 kg/m

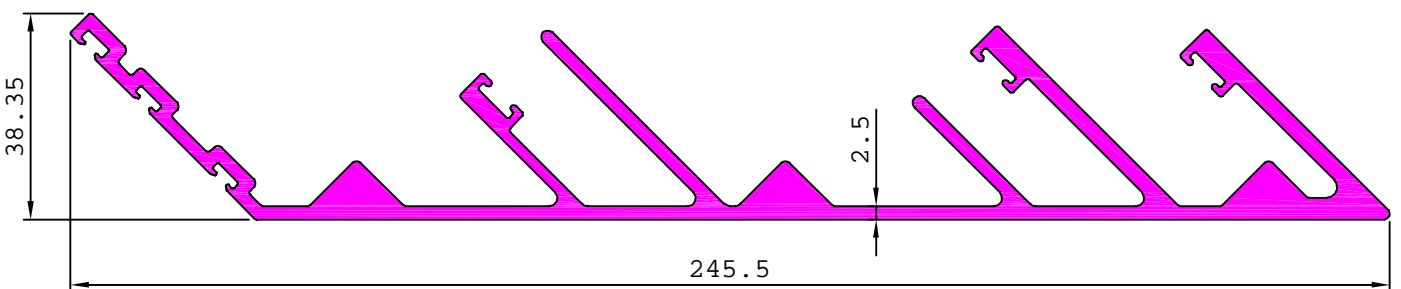

## CURTAIN WALL SECTION-AA

36378

0.482 kg/m

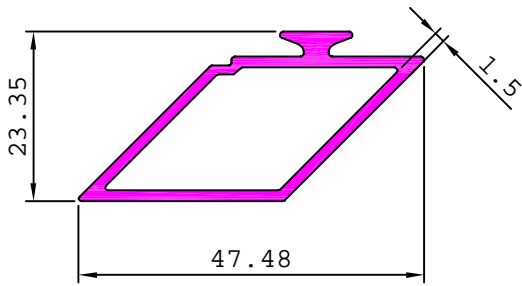

36374

0.354 kg/m

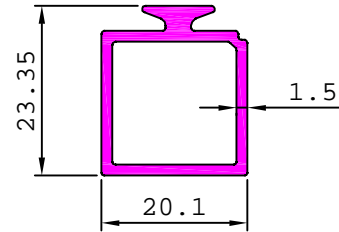

36375

0.483 kg/m

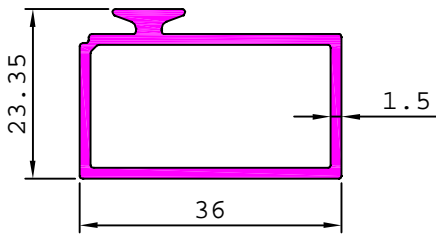

36373

0.348 kg/m

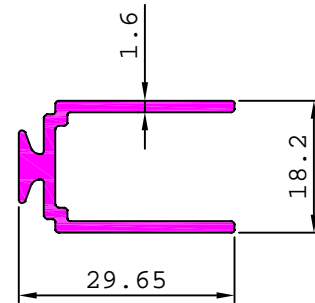

36372

0.261 kg/m

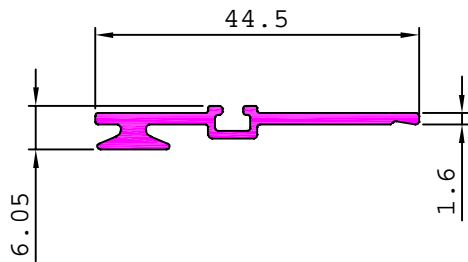

36379

0.341 kg/m

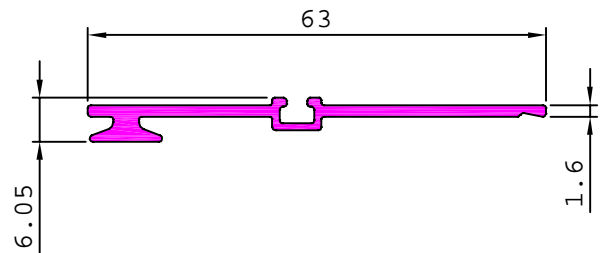

36380

0.358 kg/m

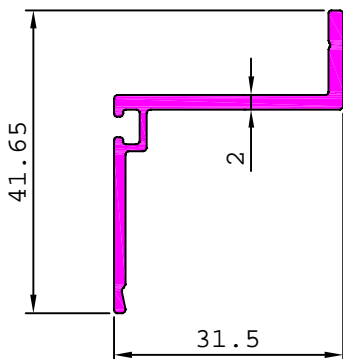

S6746

0.436 kg/m

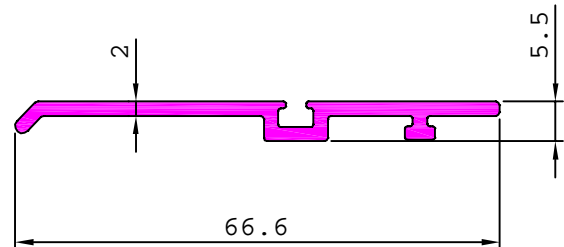

# CURTAIN WALL SECTION-A1

36421

5.206 kg/m

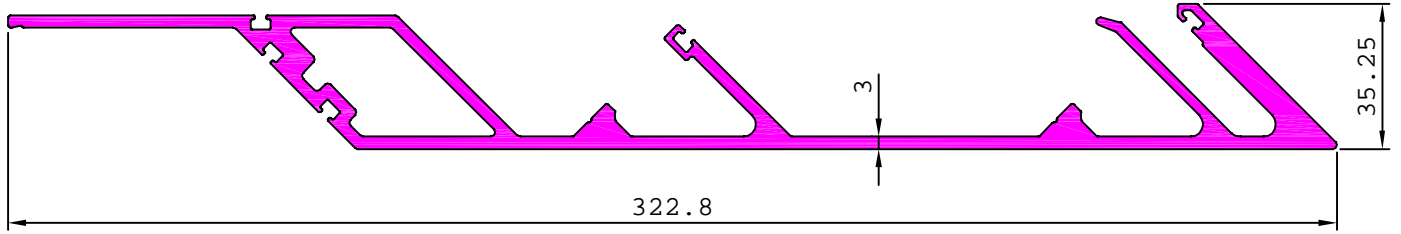

36417

3.422 kg/m

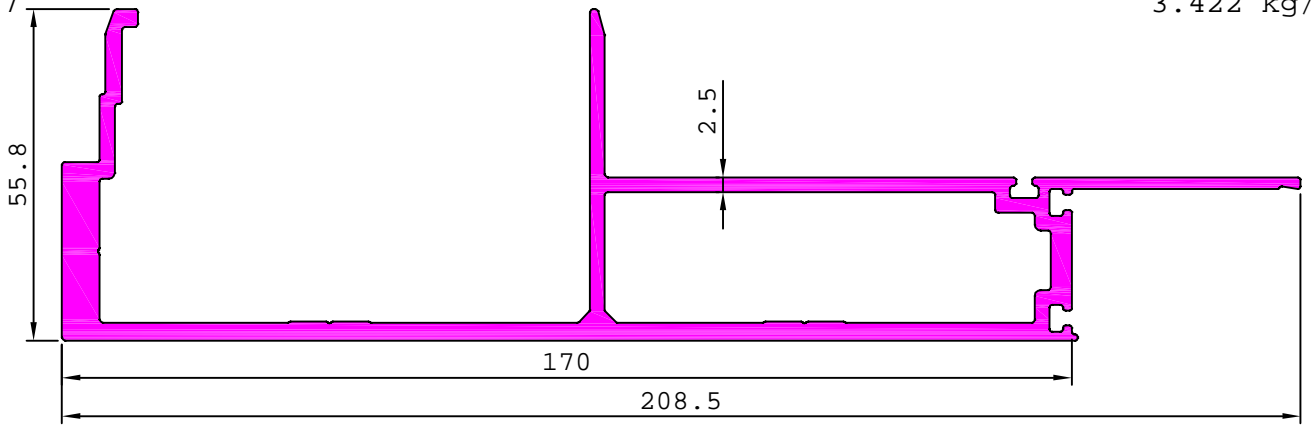

36418

3.144 kg/m

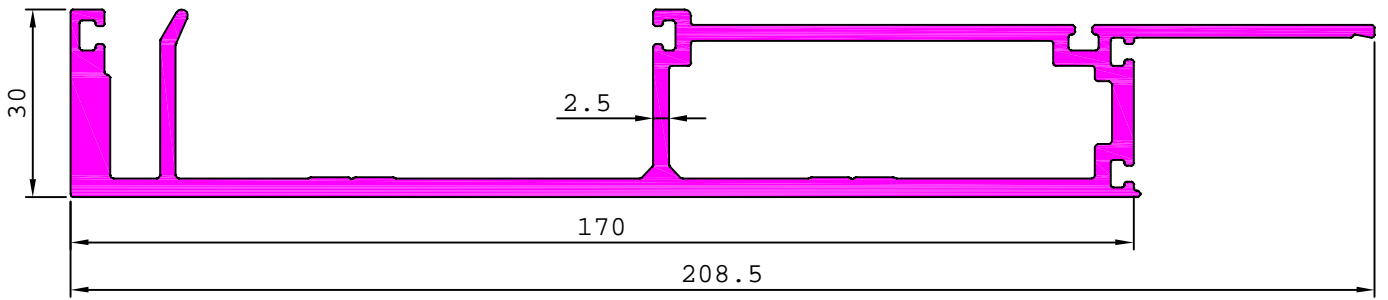

36419

3.904 kg/m

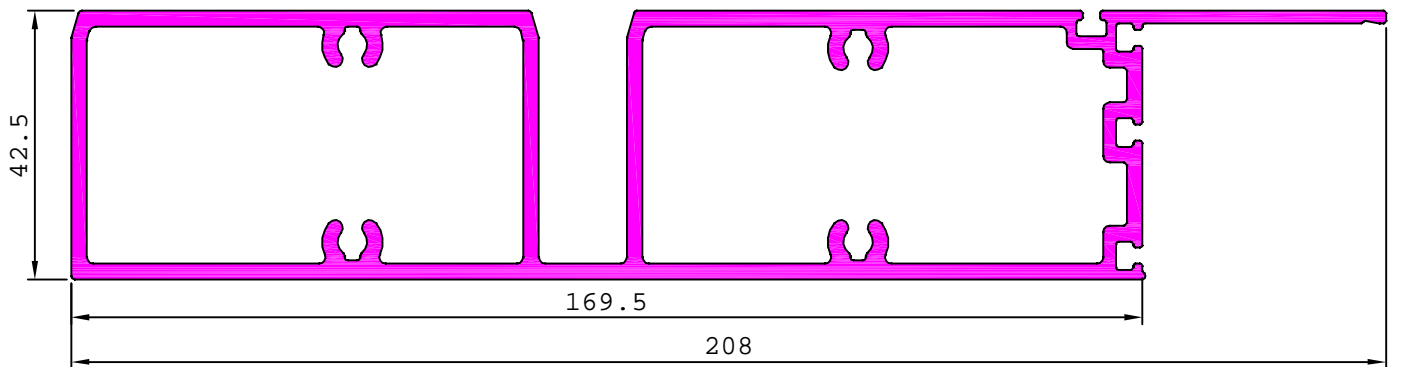

## CURTAIN WALL SECTION-AB

36394

0.230 kg/m

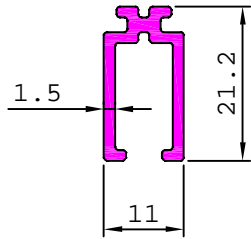

36388

0.351 kg/m

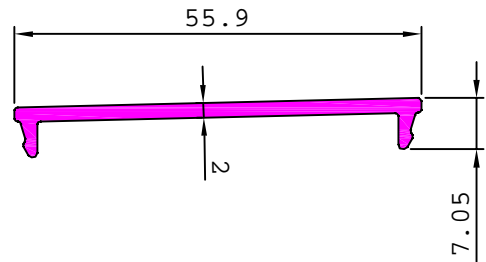

36389

1.911 kg/m

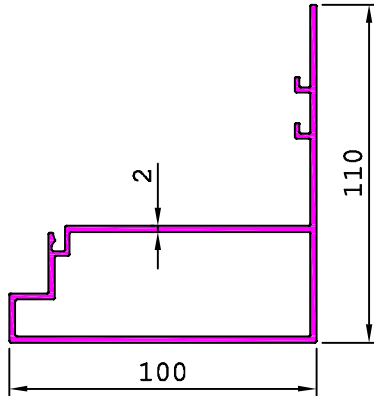

36390

0.307 kg/m

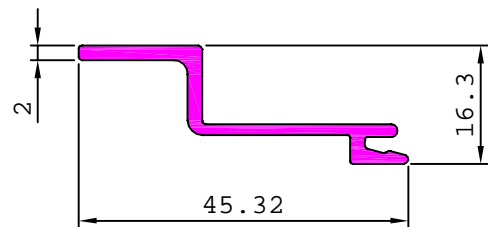

36391

2.533 kg/m

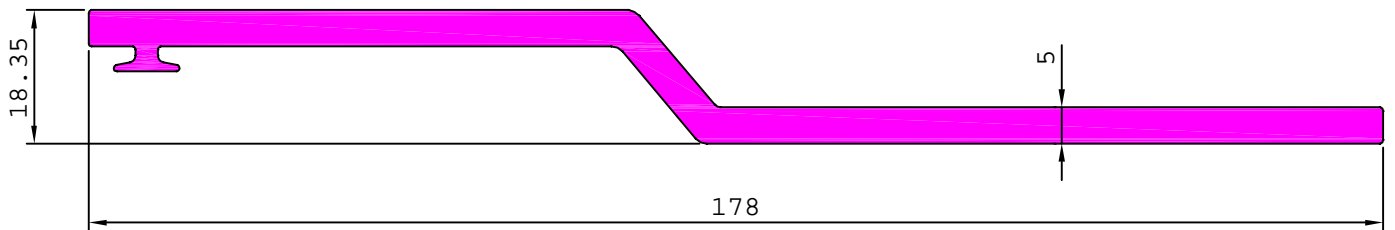

36392

1.713 kg/m

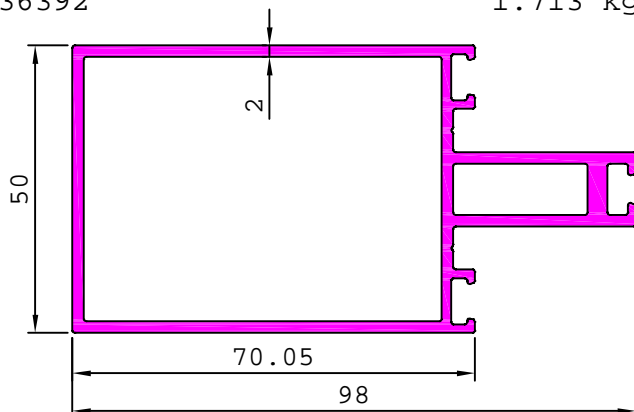

G101112

0.884 kg/m

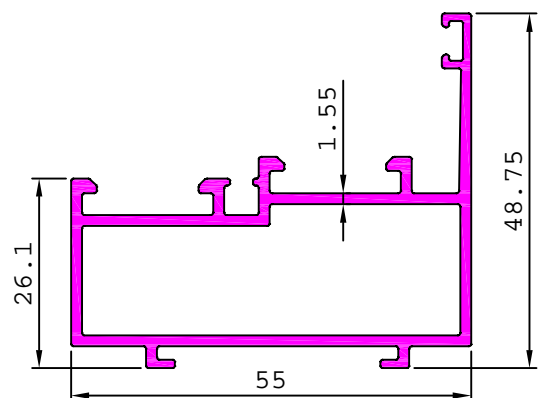

## CURTAIN WALL SECTION-AB

36385

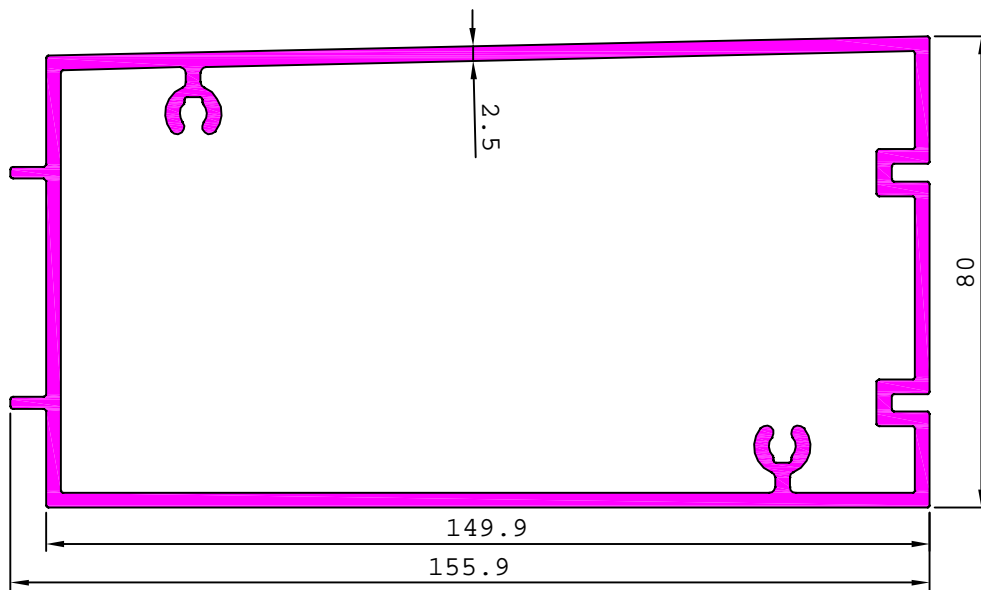

3.533 kg/m

36386

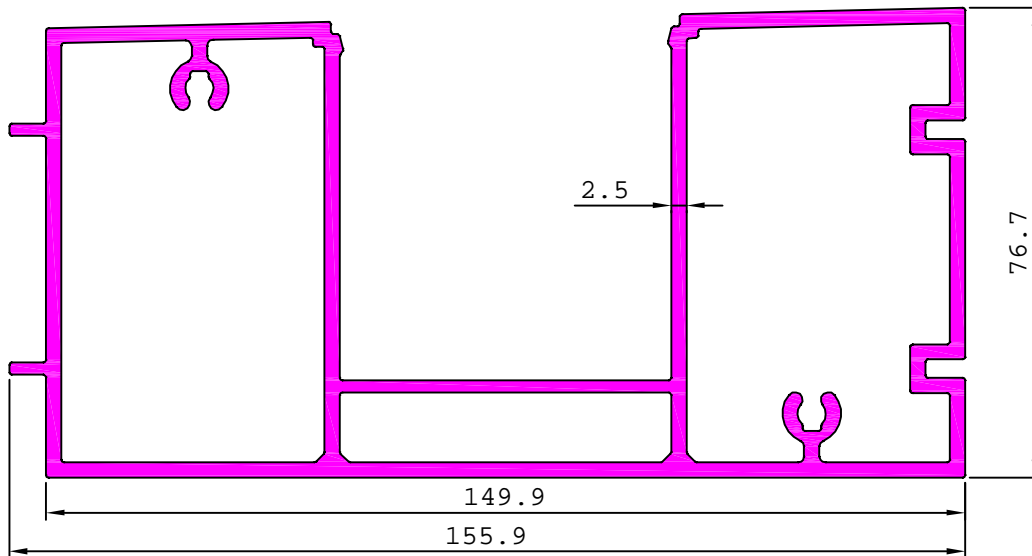

4.377 kg/m

36387

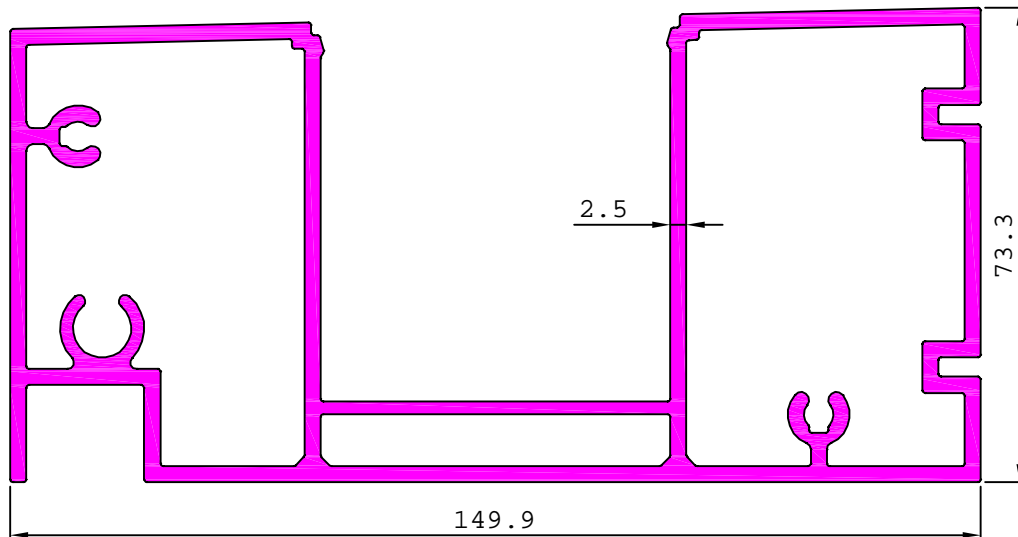

4.483 kg/m

### CURTAIN WALL SECTION-A2

36426

6.105 kg/m

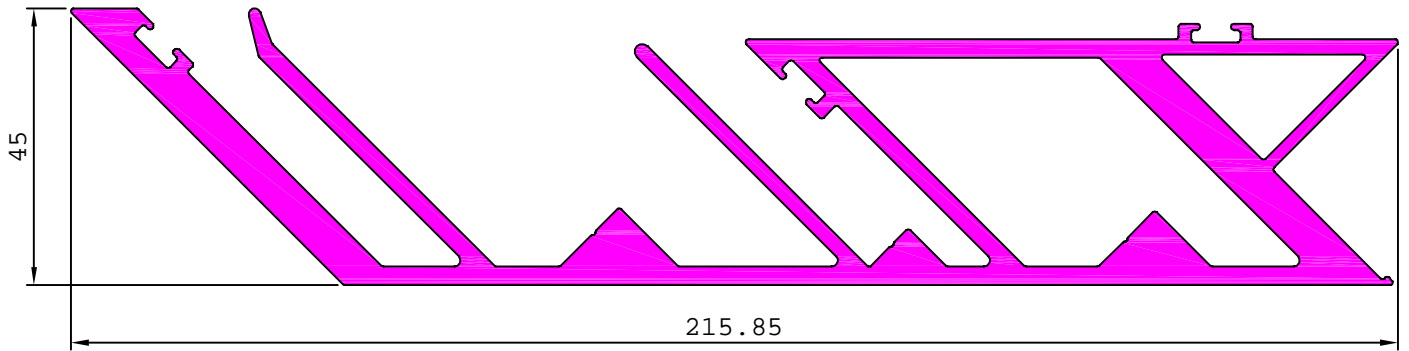

36427

5.752 kg/m

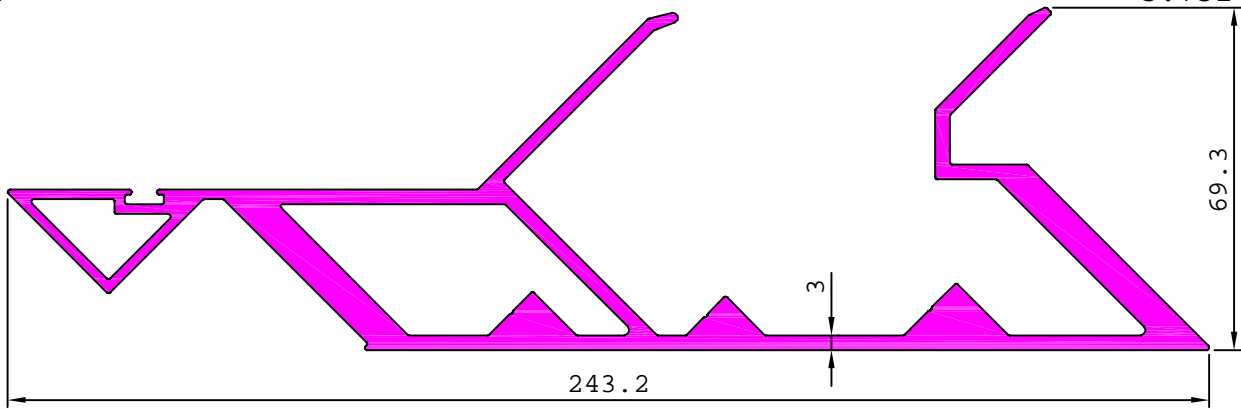

36428

6.025 kg/m

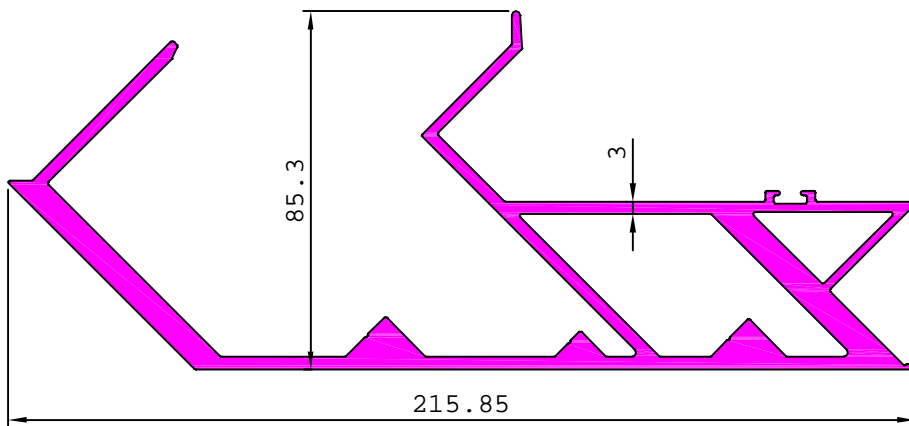

36429

6.099 kg/m

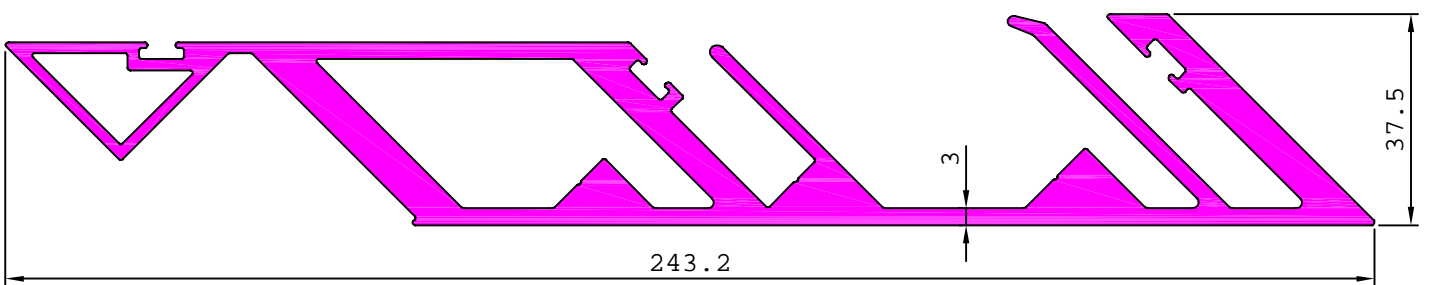

### CURTAIN WALL SECTION-A2

36434

2.819 kg/m

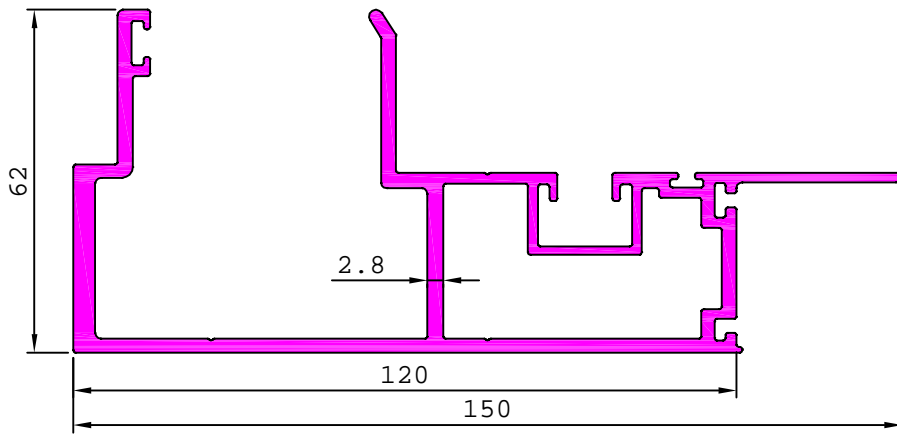

36435

3.009 kg/m

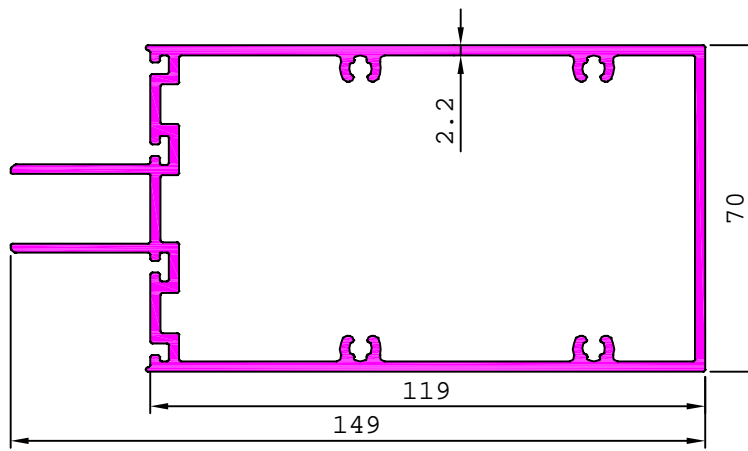

36436

2.496 kg/m

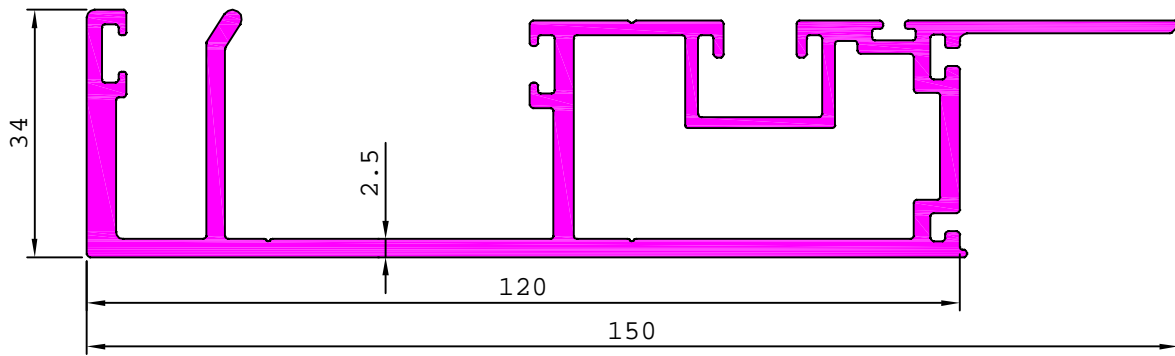

36438

2.156 kg/m

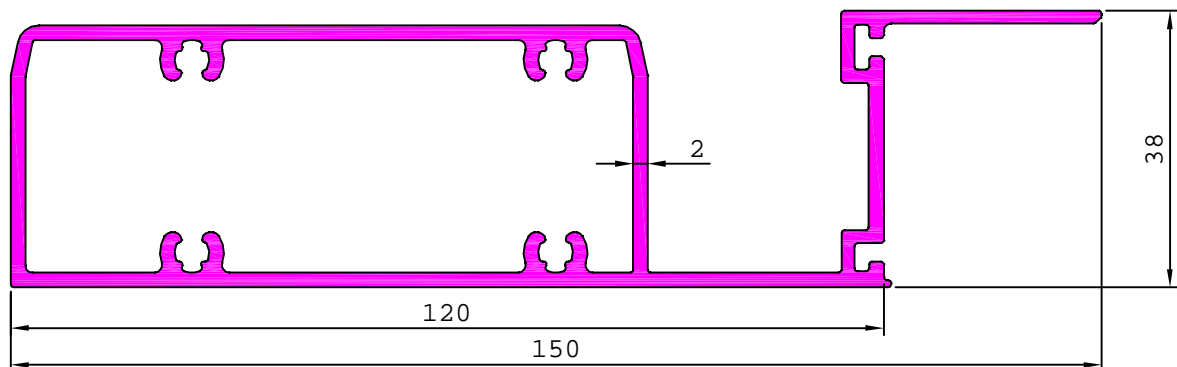

## CURTAIN WALL SECTION-A2

36437

3.566 kg/m

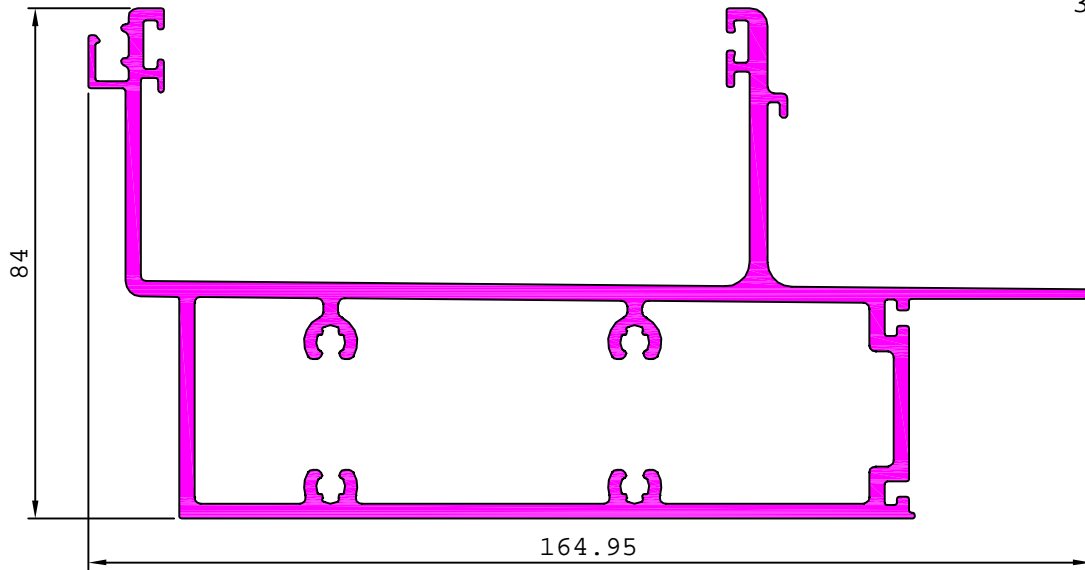

36439

3.949 kg/m

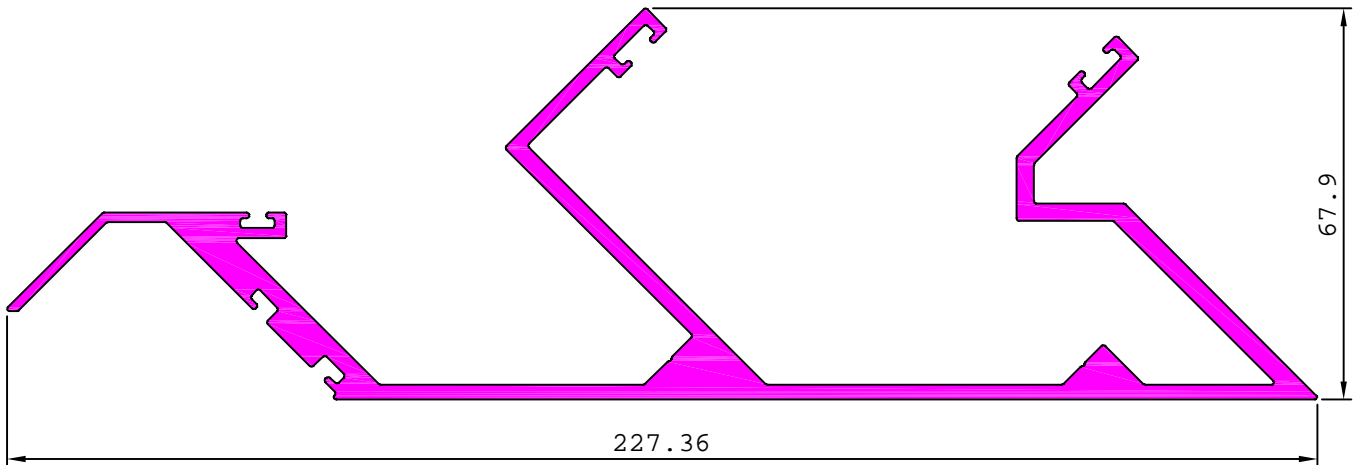

36441

4.699 kg/m

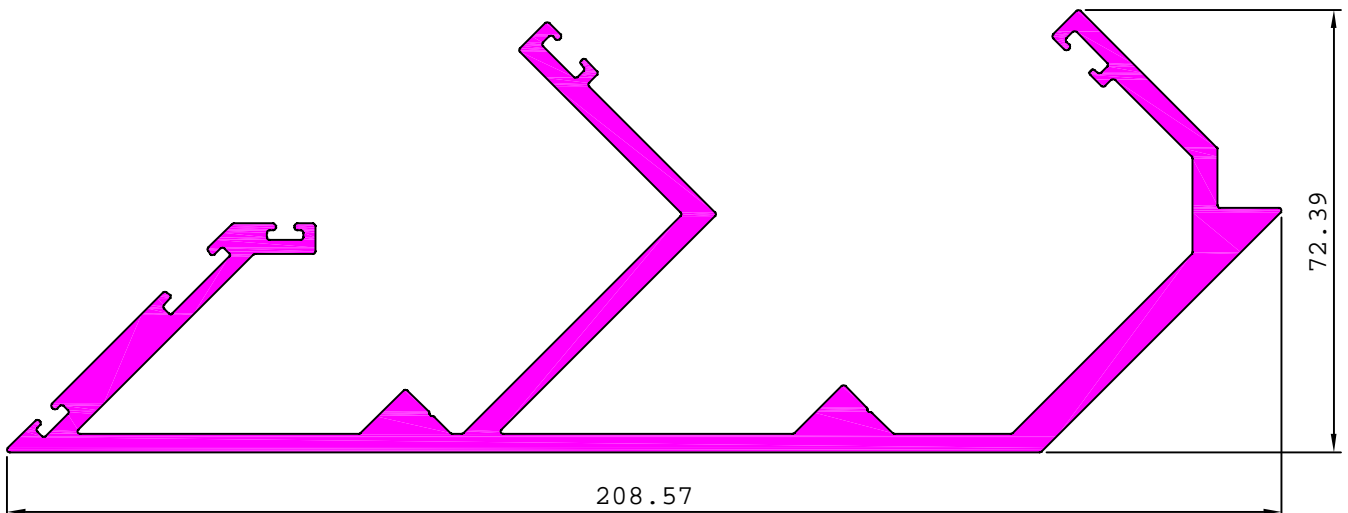

# CURTAIN WALL SECTION-AC

36430

11.934 kg/m

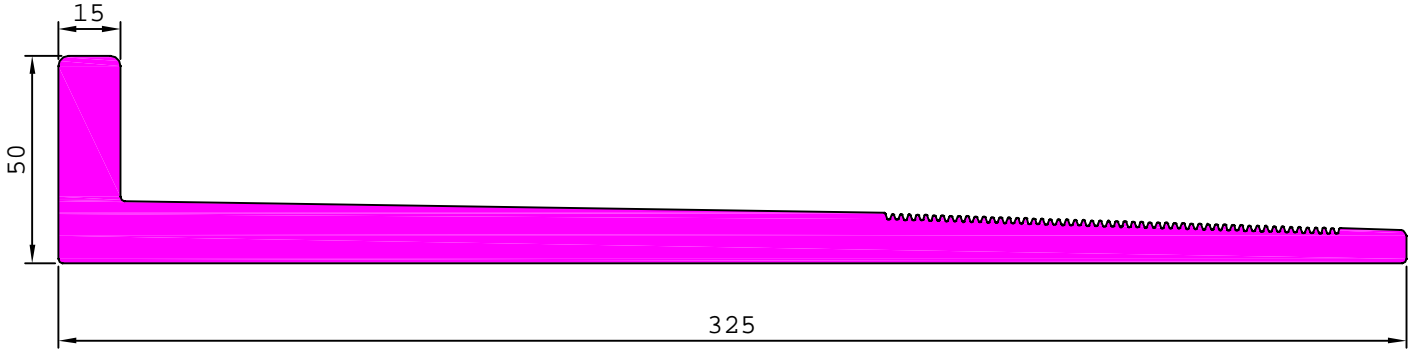

G101291

4.316 kg/m

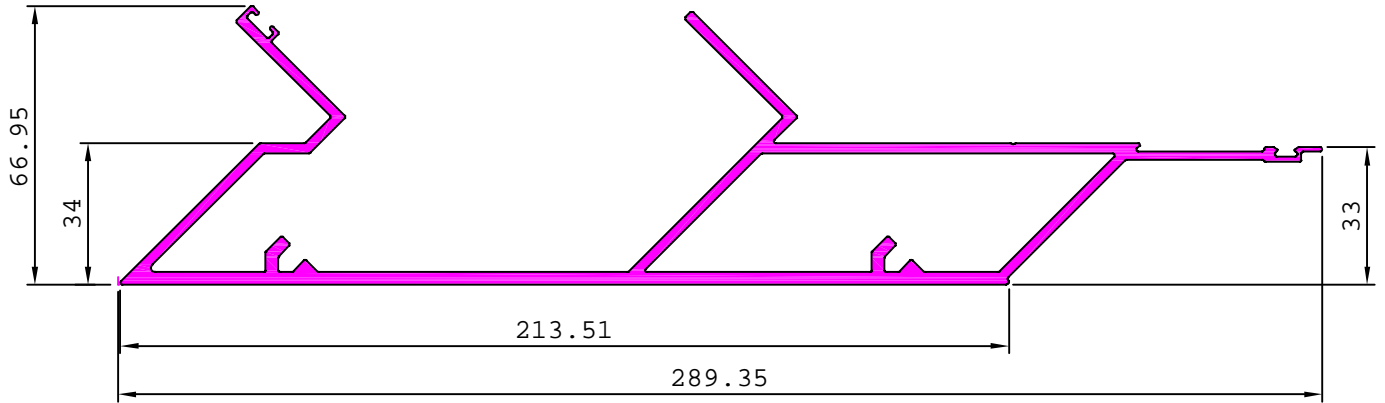

MATCHING WITH G101292

G101292

4.641 kg/m

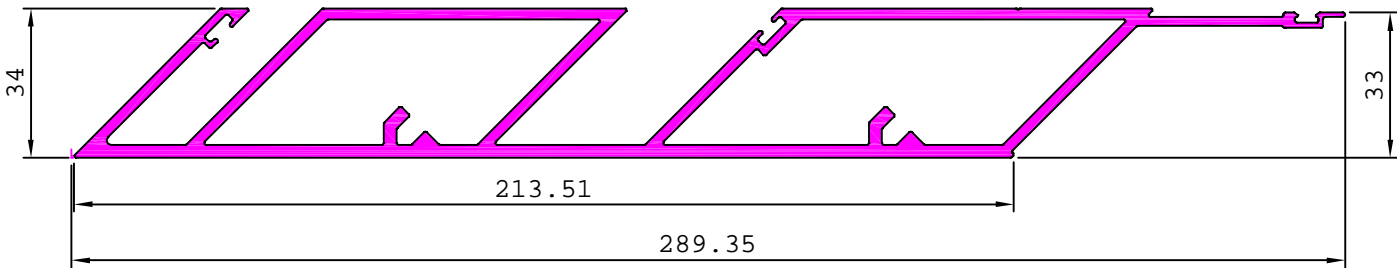

MATCHING WITH G101291

# CURTAIN WALL SECTION-AC

36440

3.946 kg/m

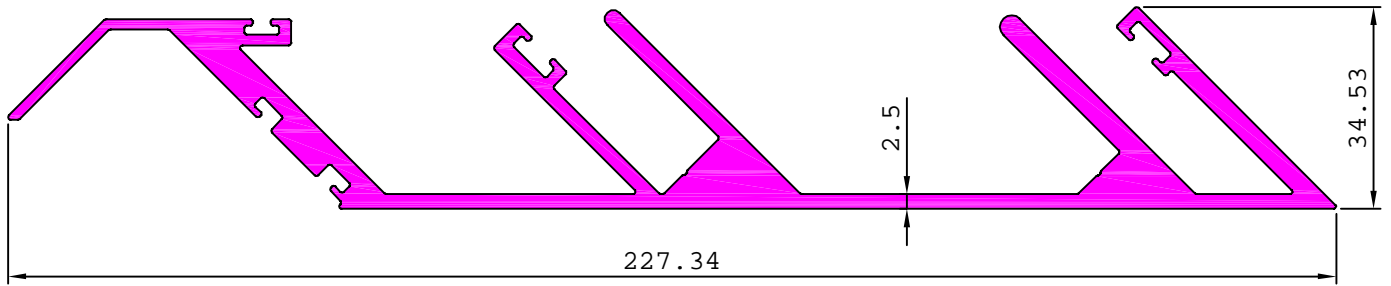

36442

4.256 kg/m

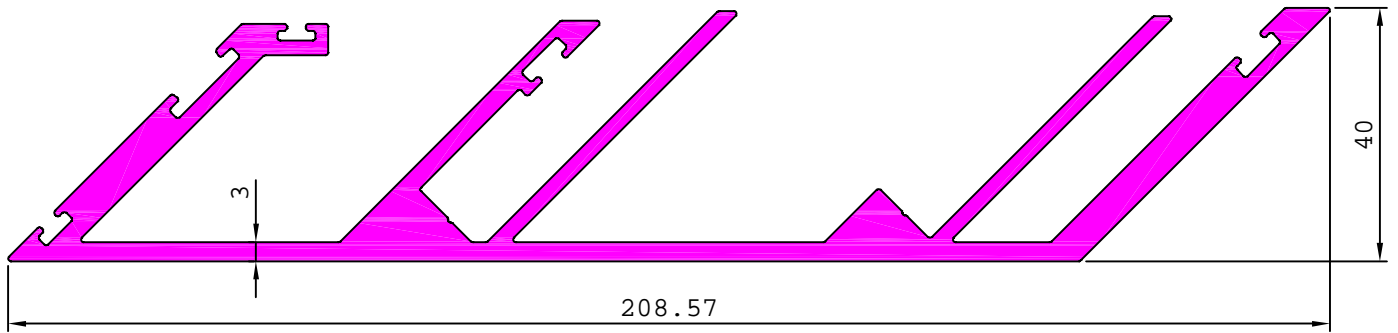

36444

5.093 kg/m

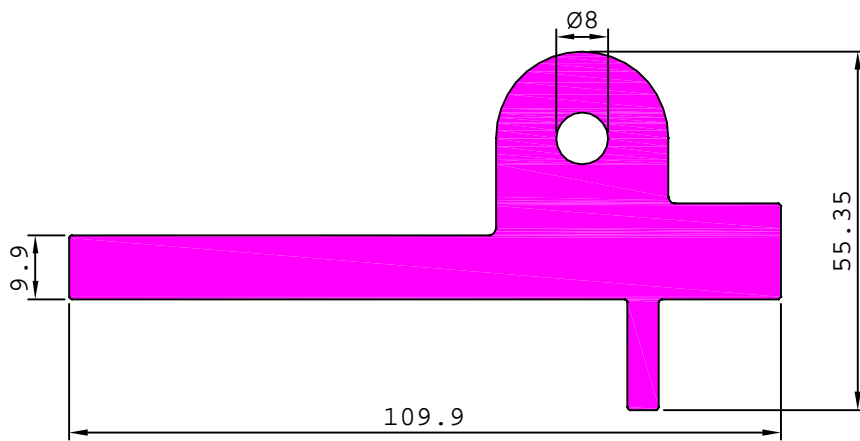

G101106

2.217 kg/m

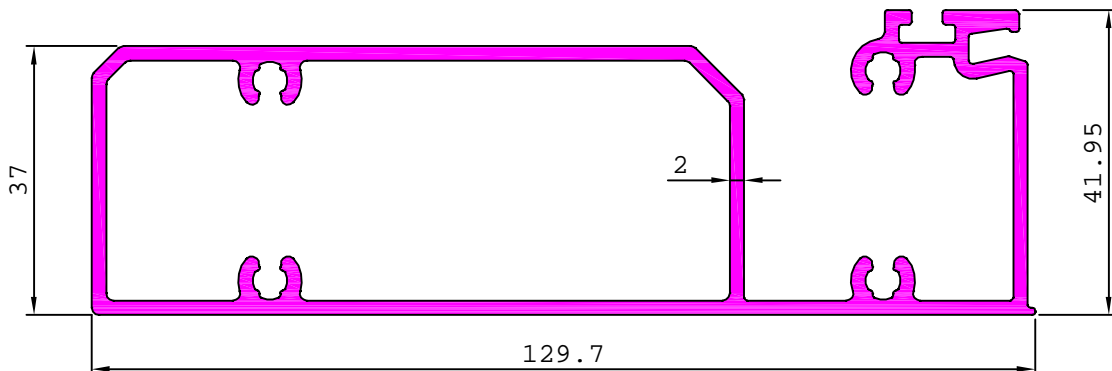

MATCHING WITH G101107 ,G101109

# CURTAIN WALL SECTION-AD

G101431

3.430 kg/m

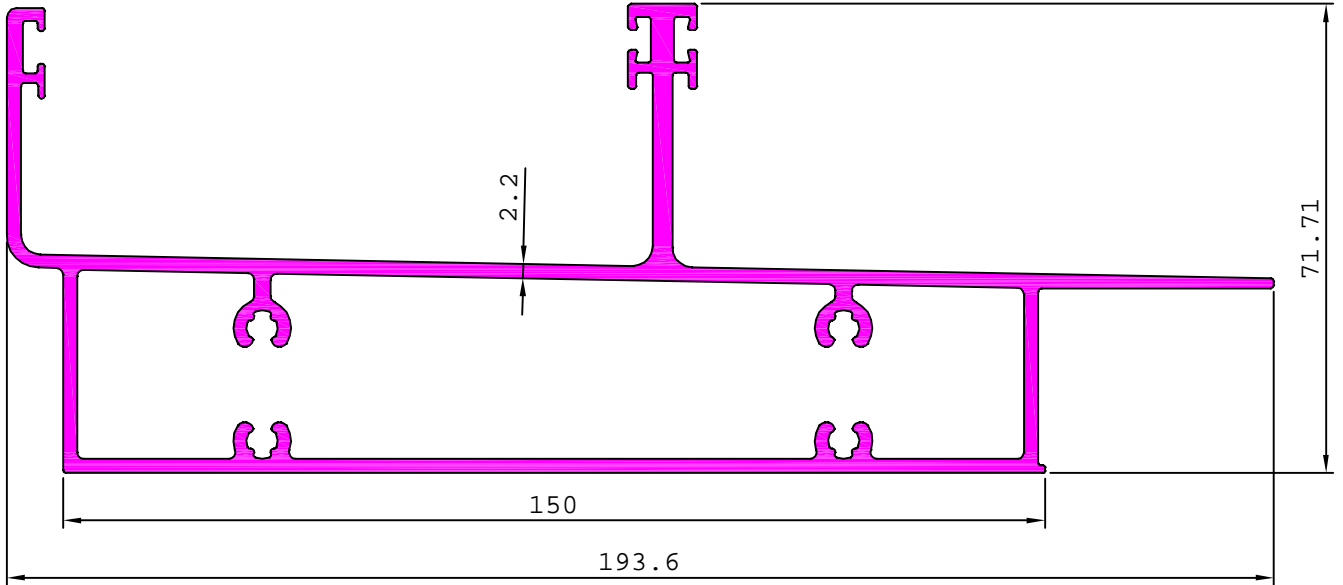

G101408

1.058 kg/m

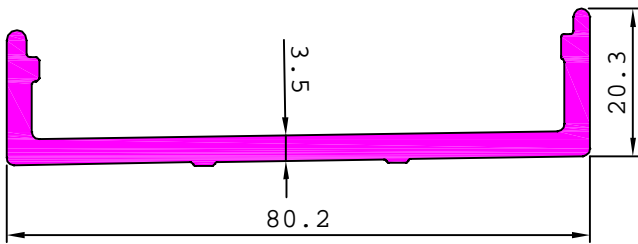

MATCHING WITH G101388

# CURTAIN WALL SECTION-AD

G101107

2.941 kg/m

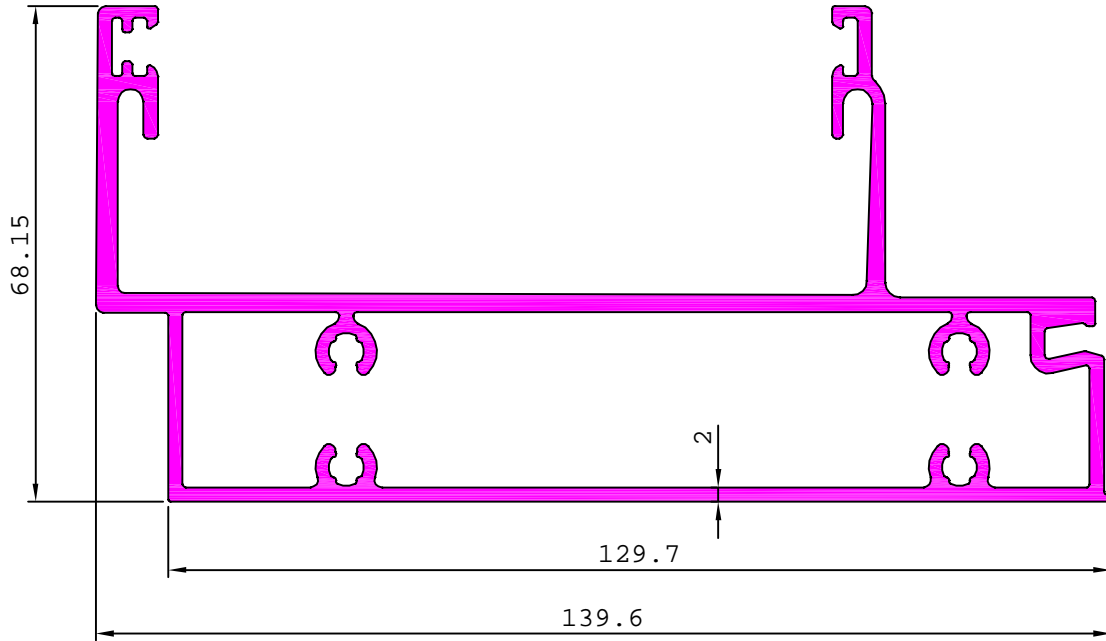

MATCHING WITH G101106 ,G101109

G101216

3.513 kg/m

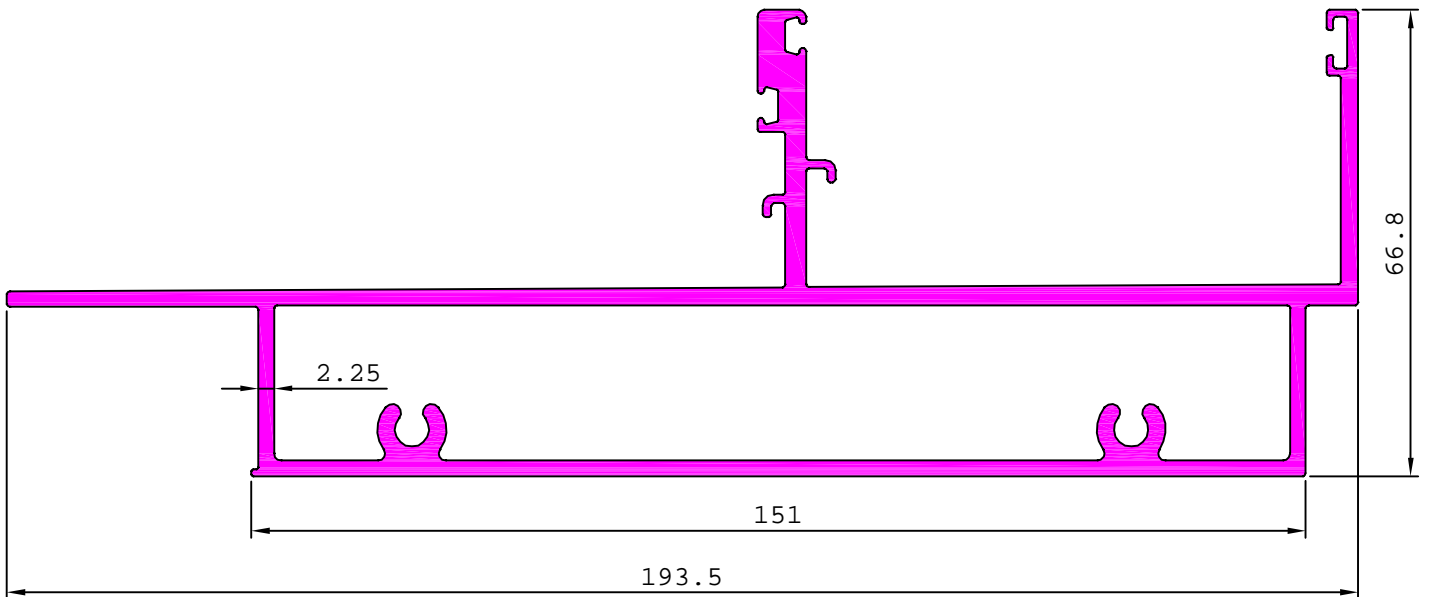

MATCHING WITH G101237

### CURTAIN WALL SECTION-AD

35763

2.427 kg/m

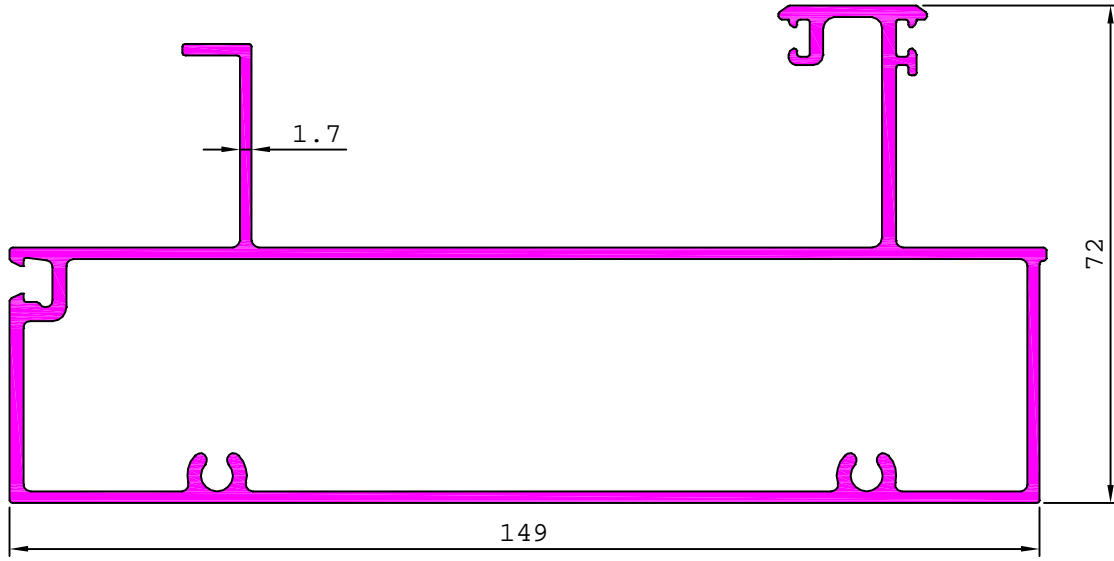

35797

8.352 kg/m

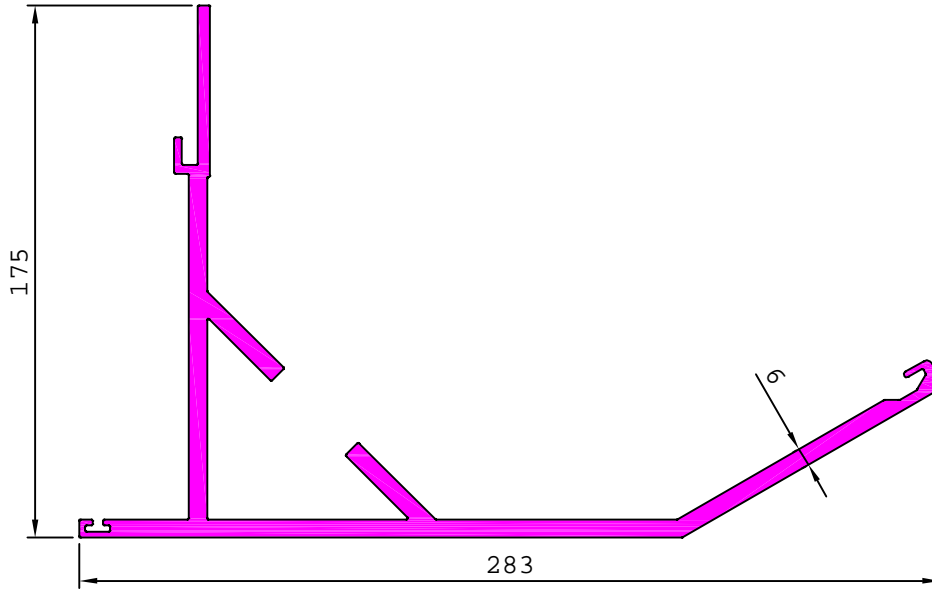

## CURTAIN WALL SECTION-AE

22827

1.848 kg/m

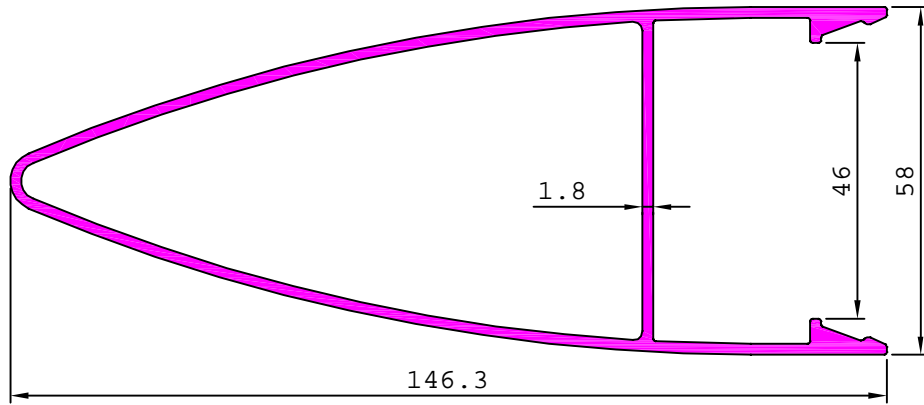

MATCHING WITH 22828

22828

0.501 kg/m

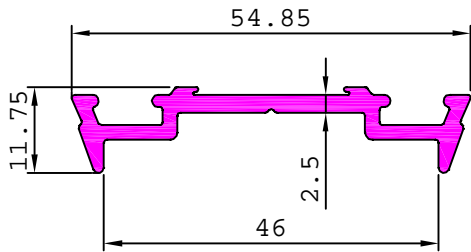

MATCHING WITH 22827

22723

1.144 kg/m

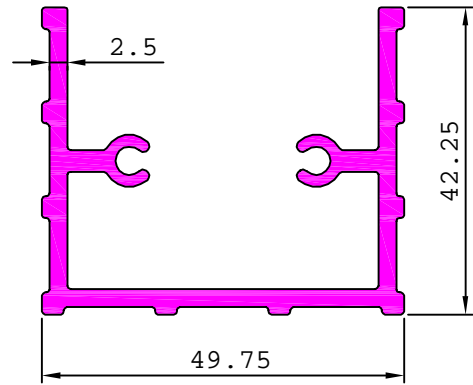

22750

0.792 kg/m

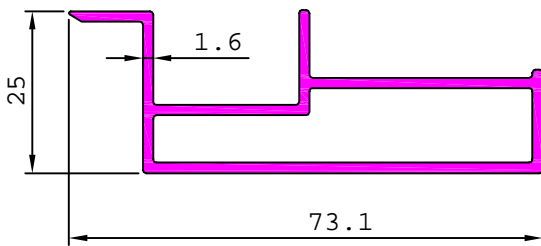

22830

1.445 kg/m

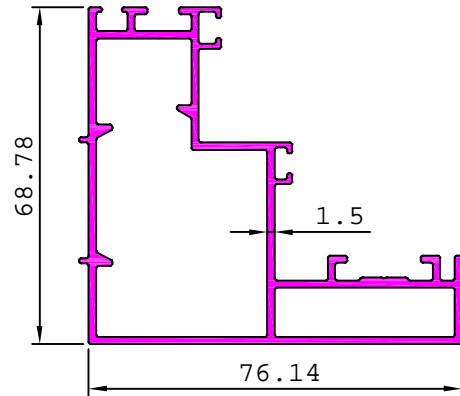

22752

3.389 kg/m

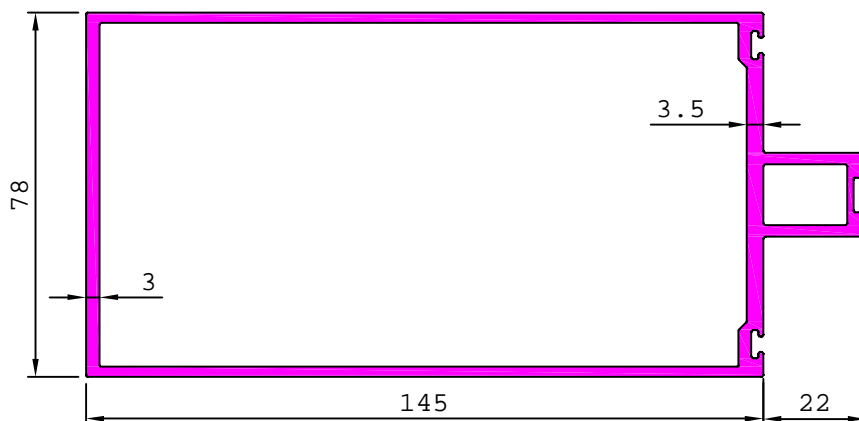

## CURTAIN WALL SECTION-AE

28851

2.351 kg/m

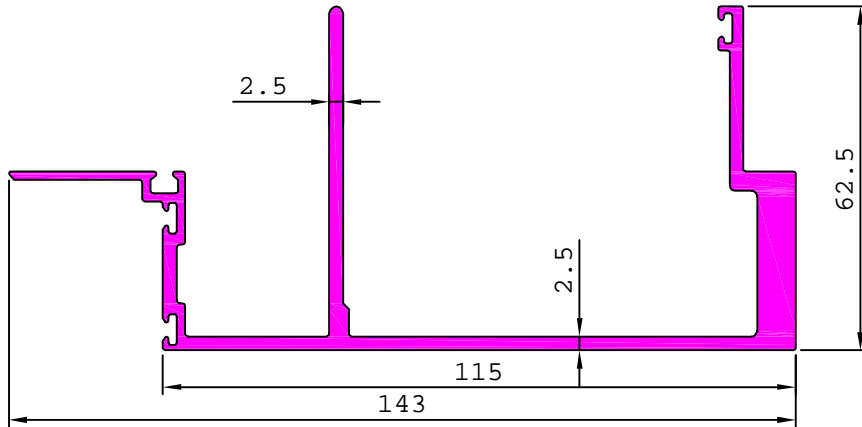

28852

1.881 kg/m

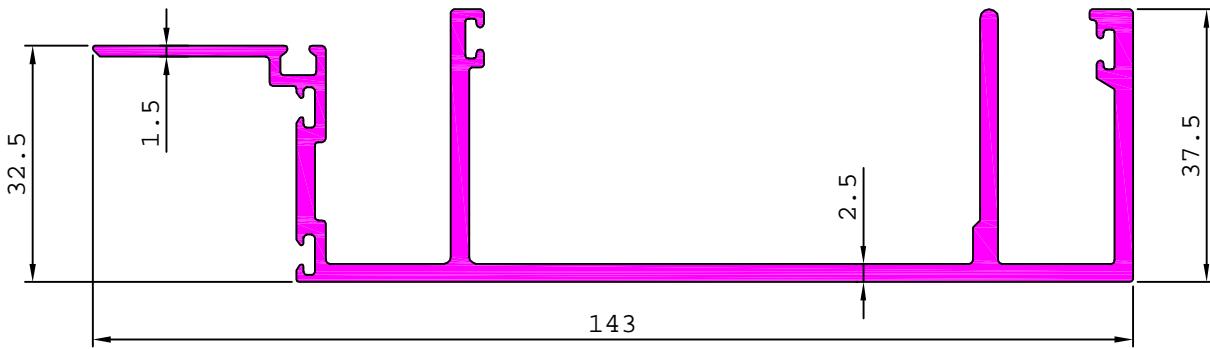

28854

2.140 kg/m

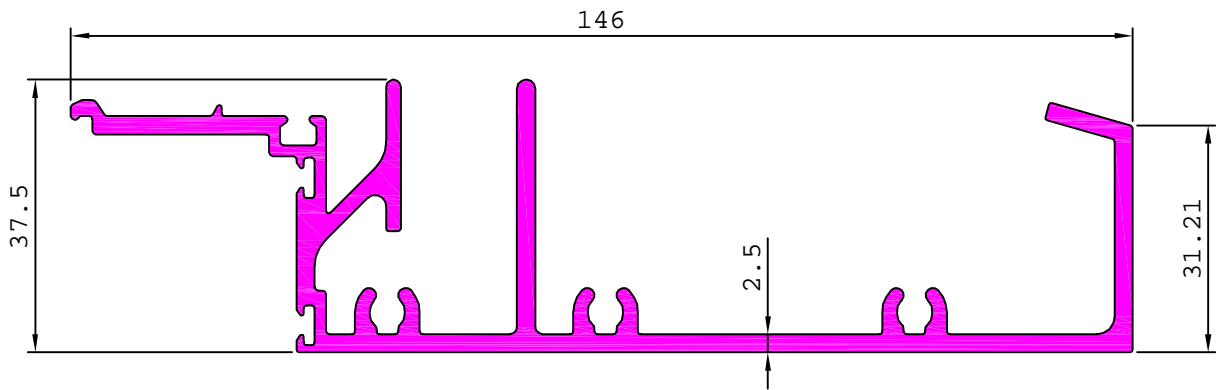

28879

0.791 kg/m

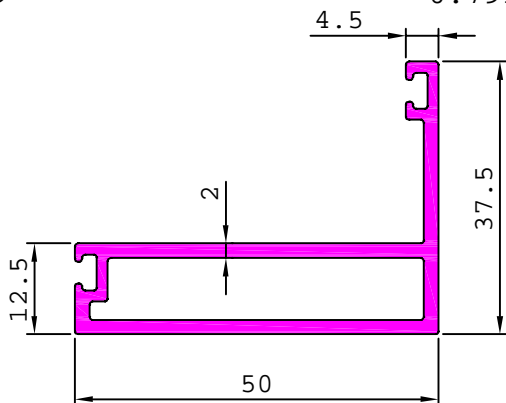

28853

2.481 kg/m

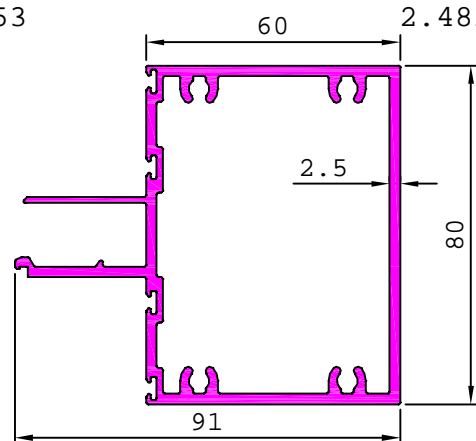

## CURTAIN WALL SECTION-AE

28855

3.305 kg/m

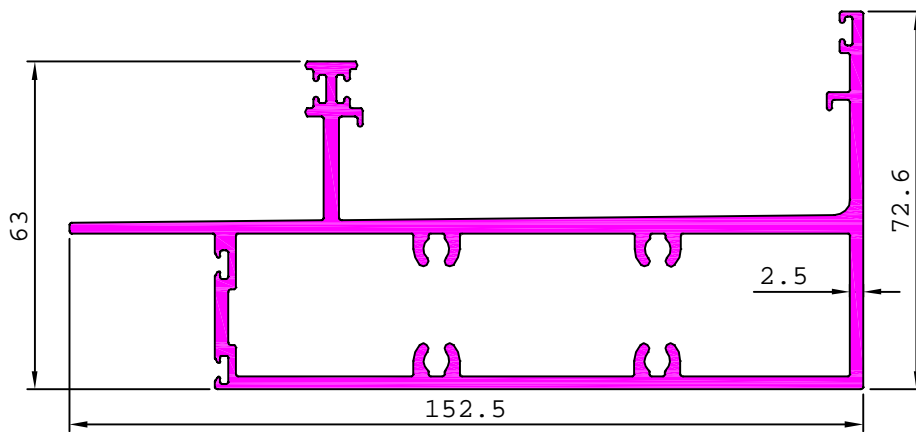

28875

1.123 kg/m

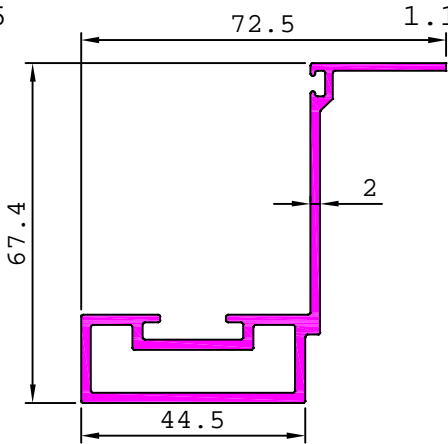

35880

1.813 kg/m

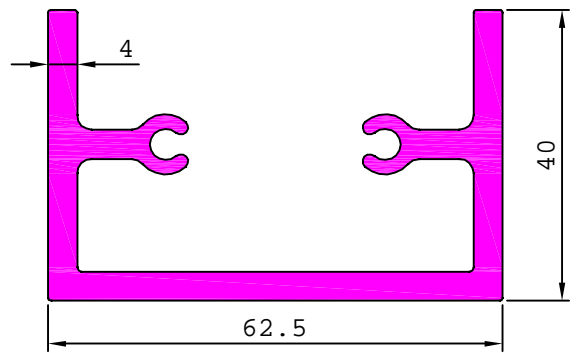

28908

2.592 kg/m

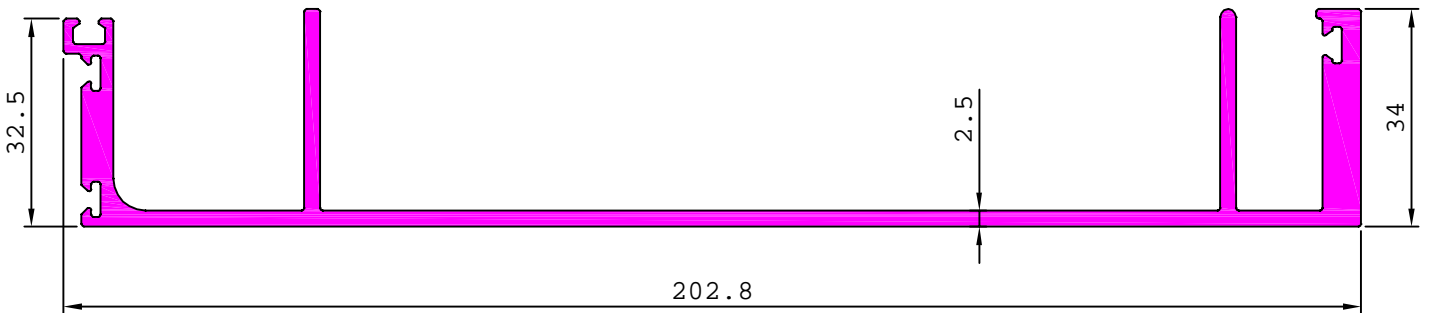

28910

2.749 kg/m

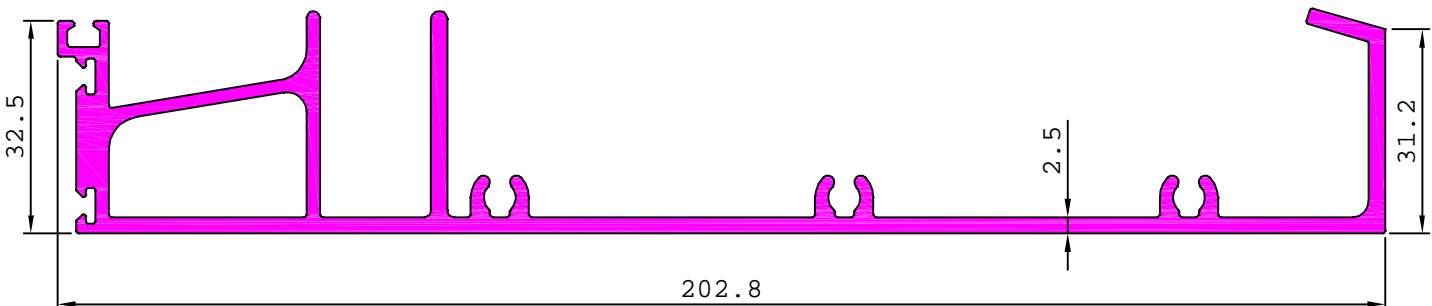

## CURTAIN WALL SECTION-AF

28909

3.121 kg/m

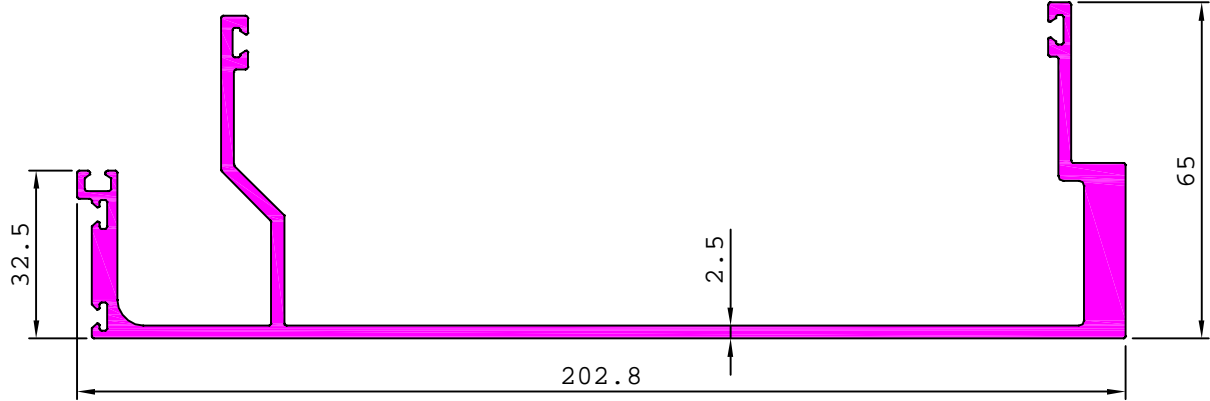

28912

4.542 kg/m

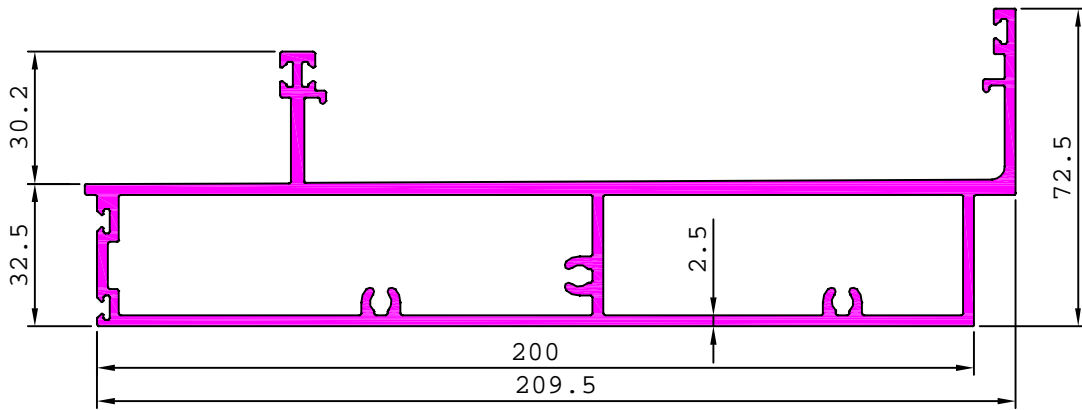

28941

2.517 kg/m

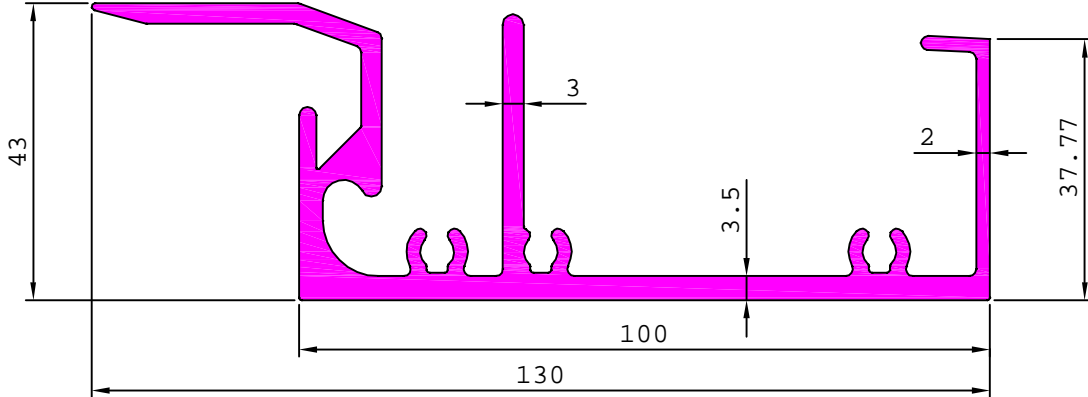

28942

3.190 kg/m

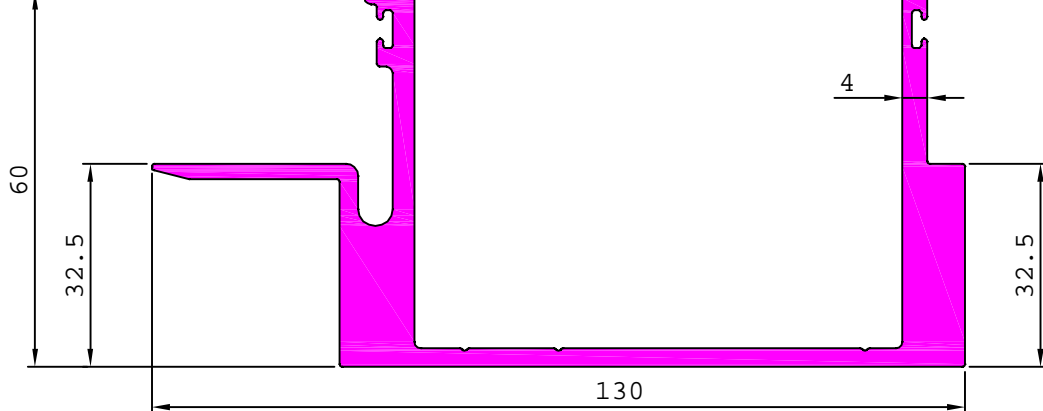

### CURTAIN WALL SECTION-AF

28943

2.961 kg/m

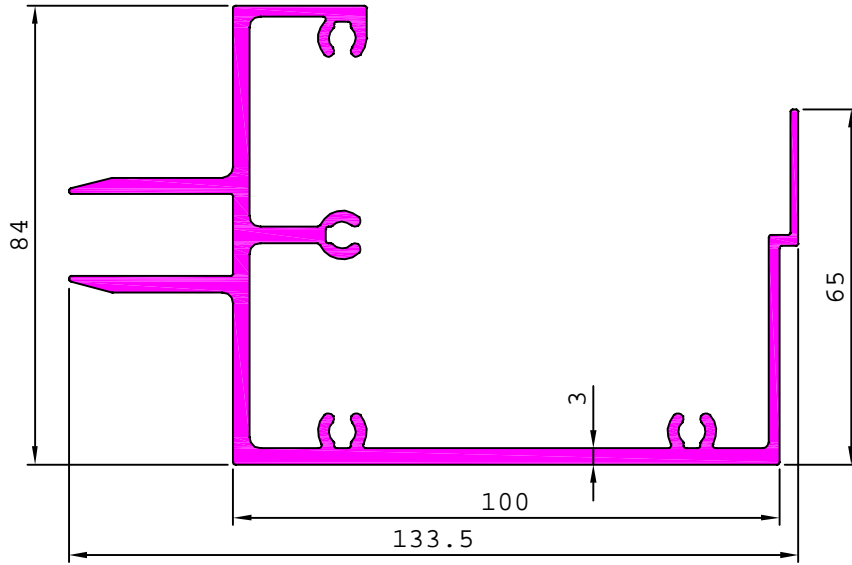

28944

3.437 kg/m

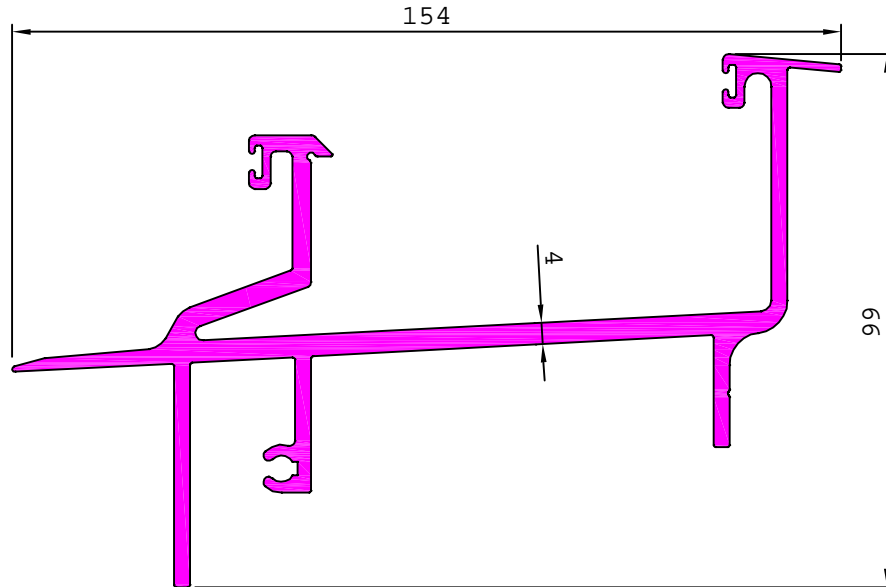

28965

2.814 kg/m

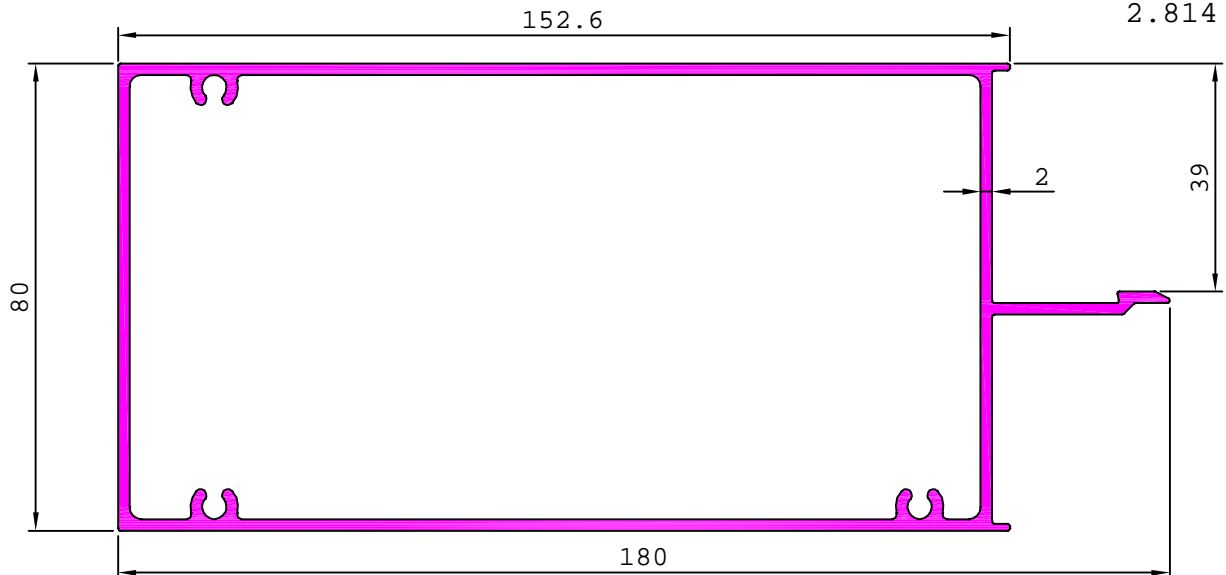

## CURTAIN WALL SECTION-AG

28945

1.632 kg/m

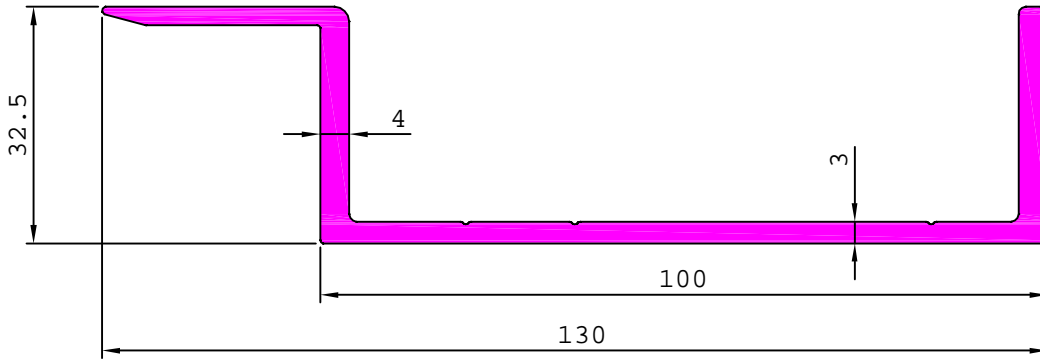

29105

0.497 kg/m

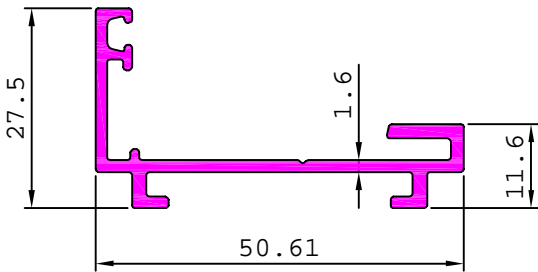

29106

1.379 kg/m

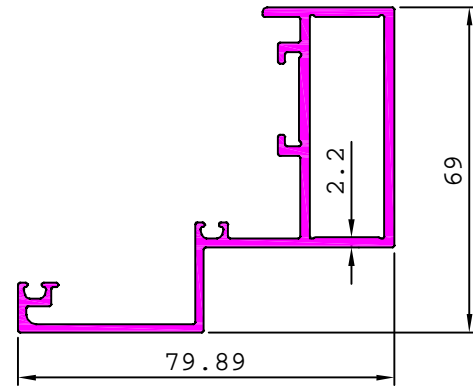

29154

1.497 kg/m

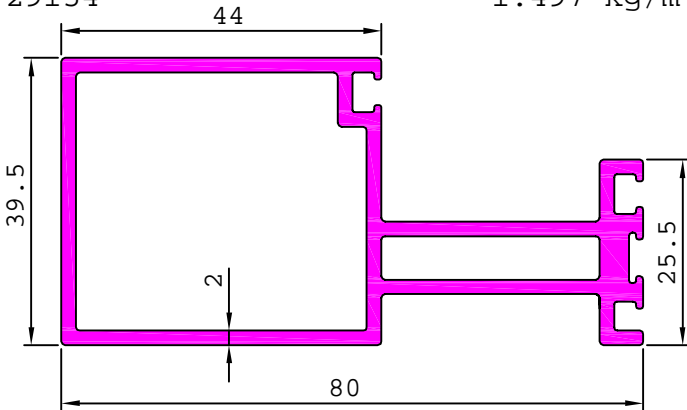

29155

0.688 kg/m

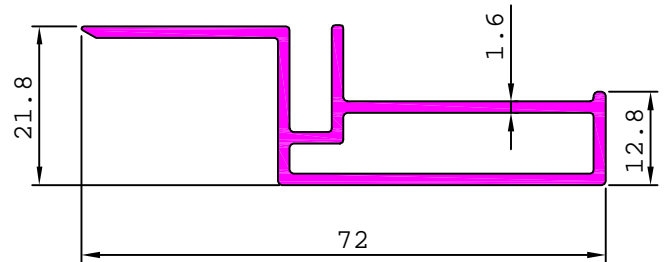

29161

2.638 kg/m

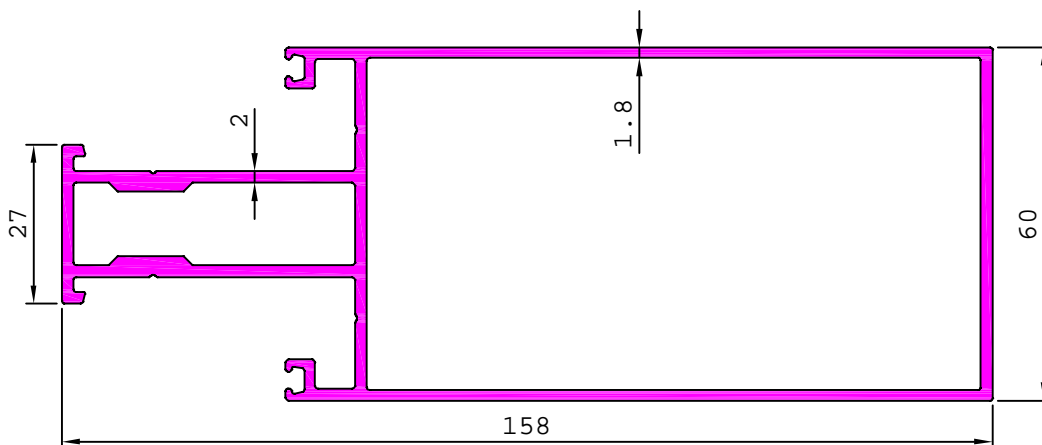

## CURTAIN WALL SECTION-AG

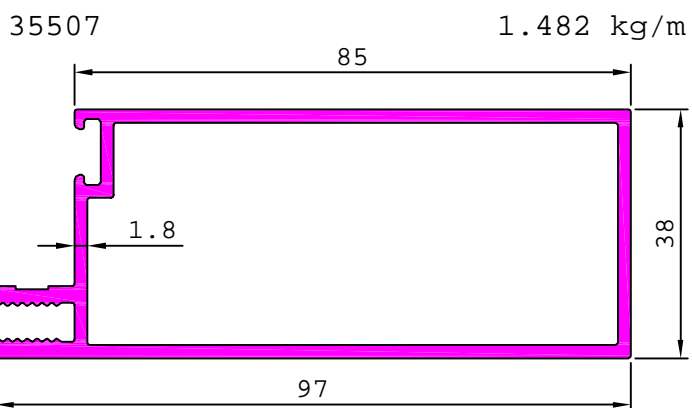
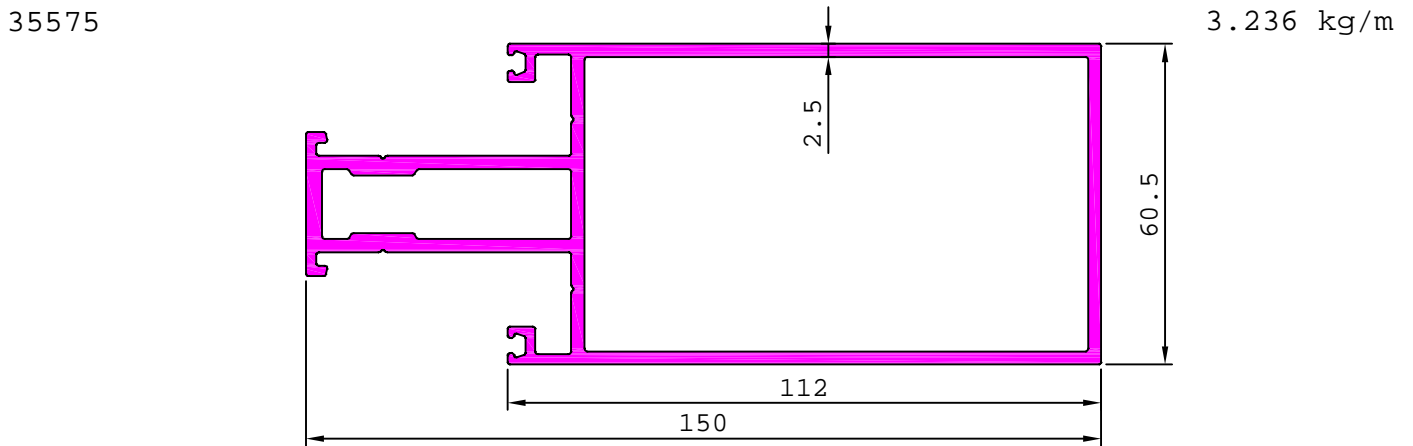
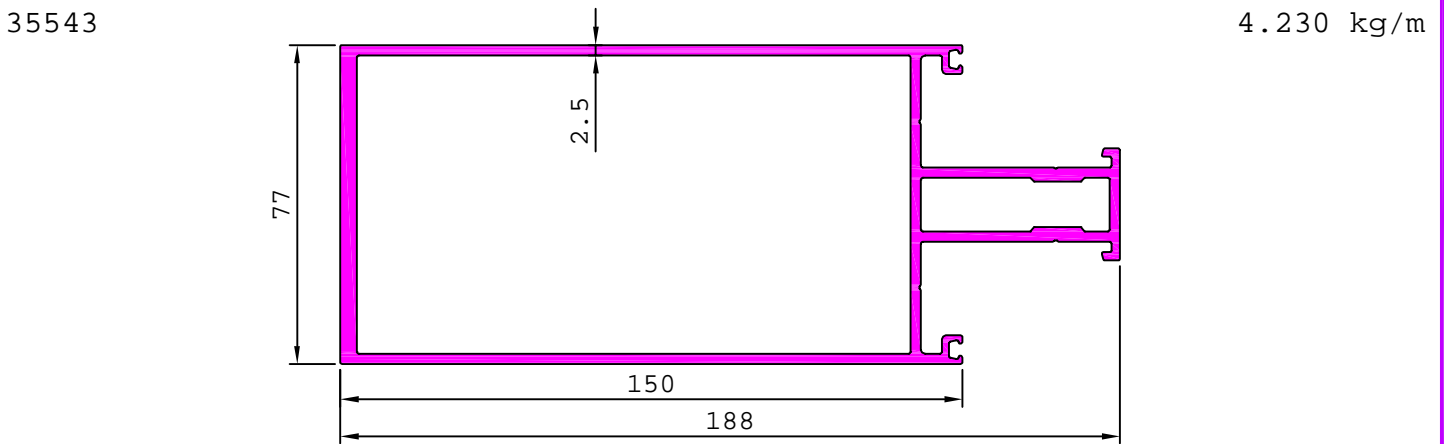
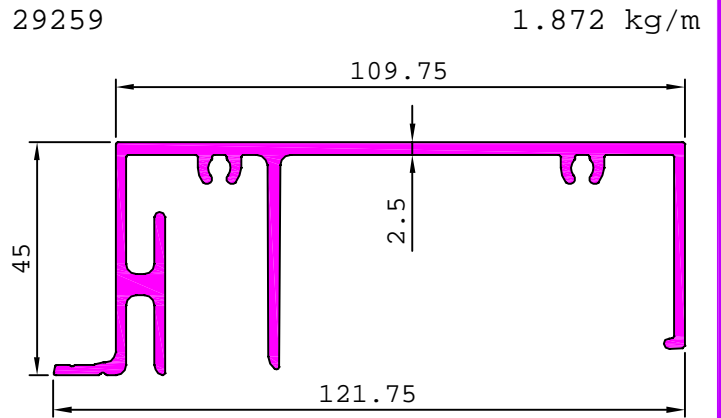
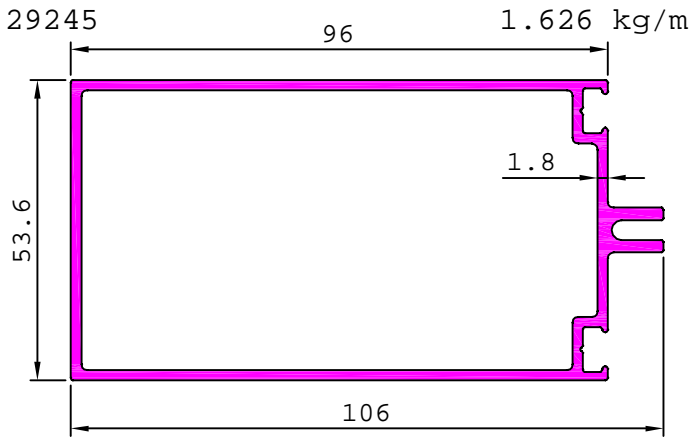

### CURTAIN WALL SECTION-AH

35550

4.598 kg/m

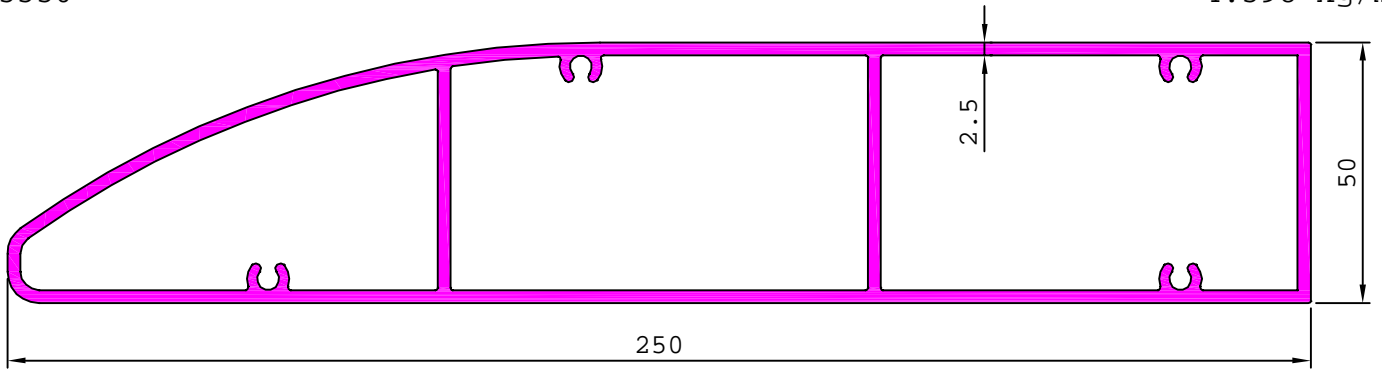

35625

3.447 kg/m

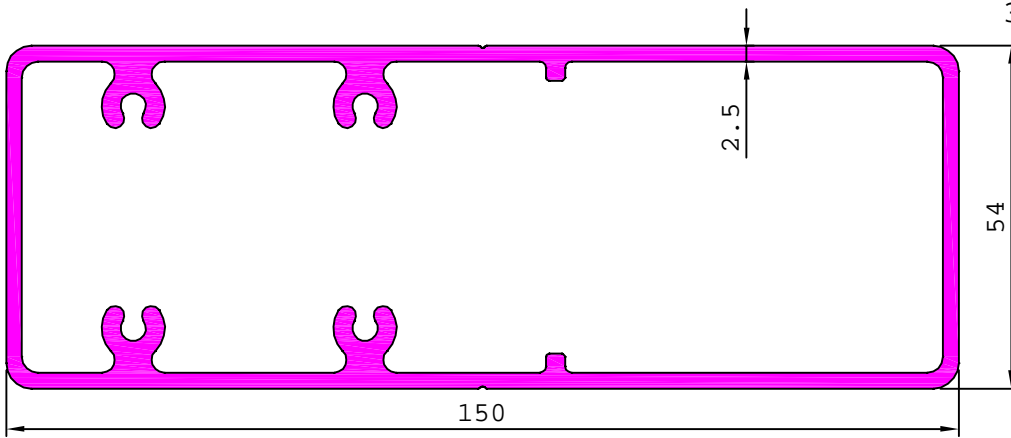

35870

2.756 kg/m

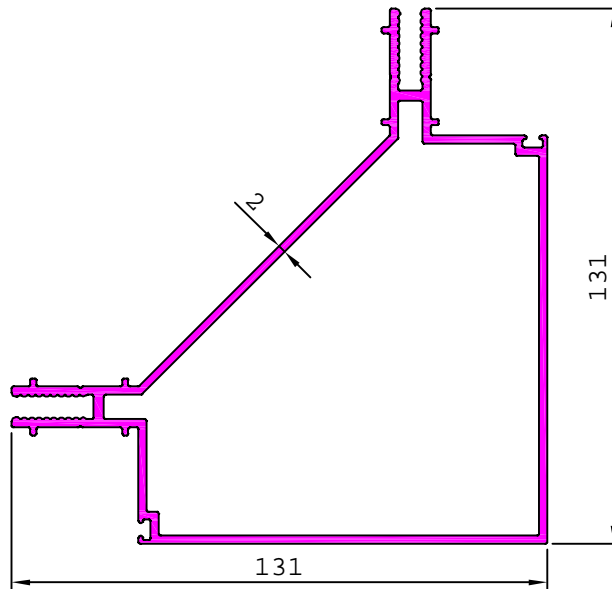

## CURTAIN WALL SECTION-AH

35576

0.589 kg/m

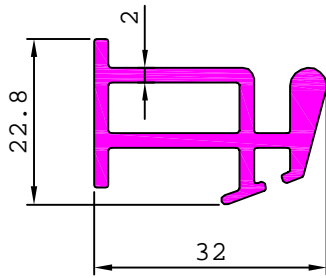

35582

0.471 kg/m

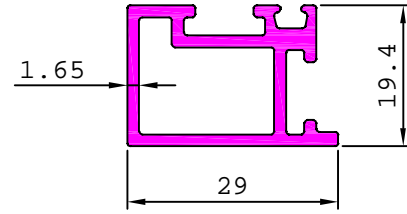

35585

1.120 kg/m

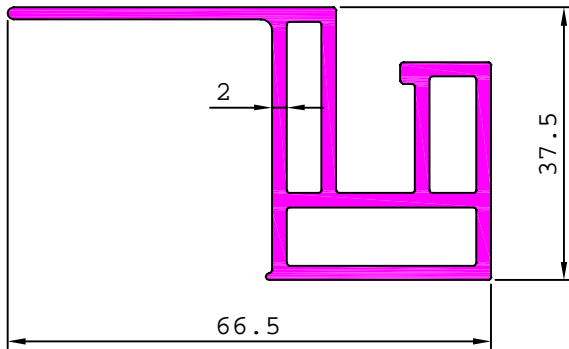

35596

0.367 kg/m

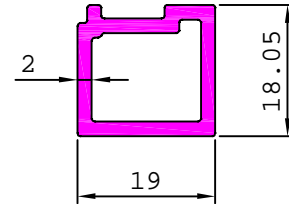

35630

0.368 kg/m

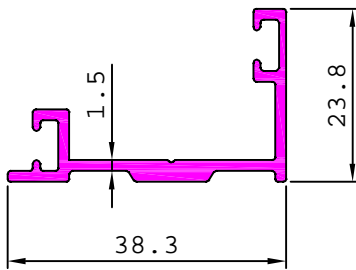

35636

0.565 kg/m

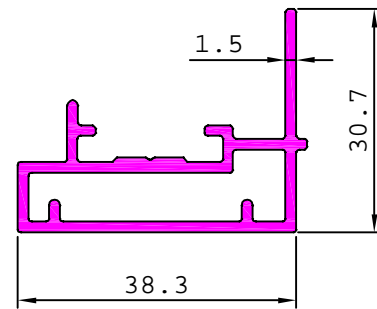

35566

0.755 kg/m

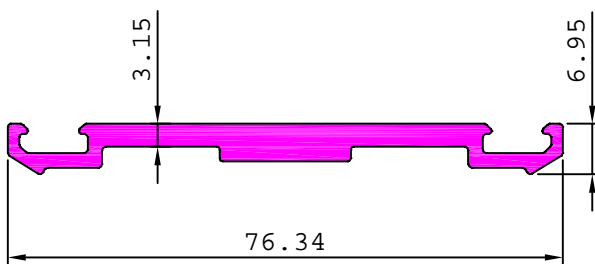

35629

0.860 kg/m

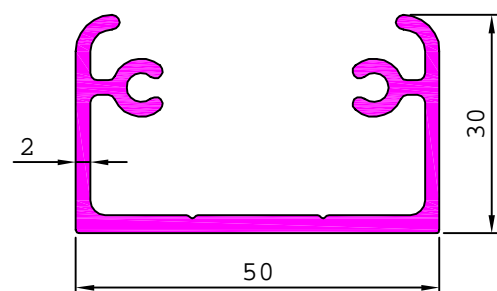

# CURTAIN WALL SECTION-AI

35579

6.157 kg/m

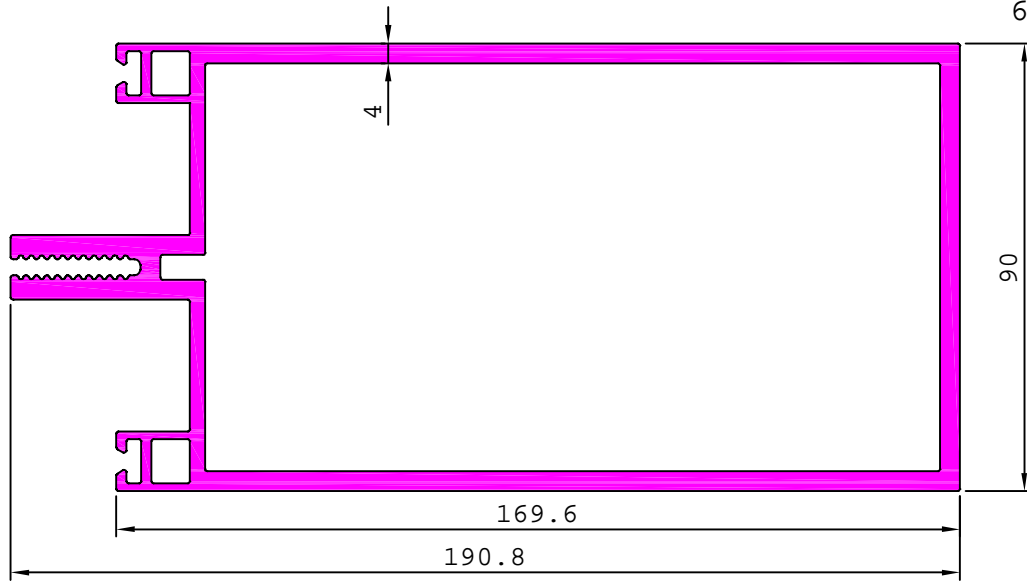

35588

3.201 kg/m

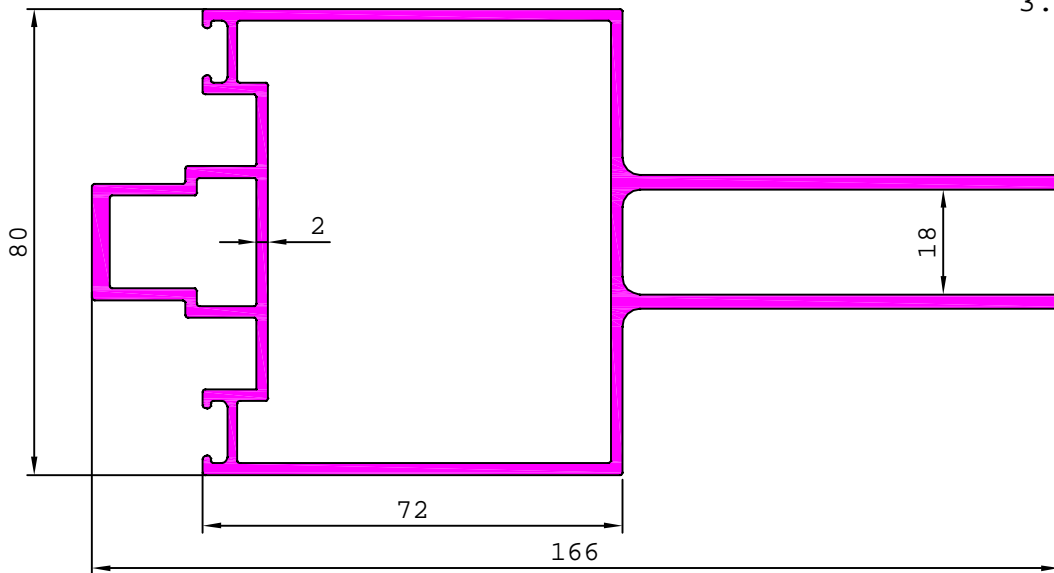

35641

4.494 kg/m

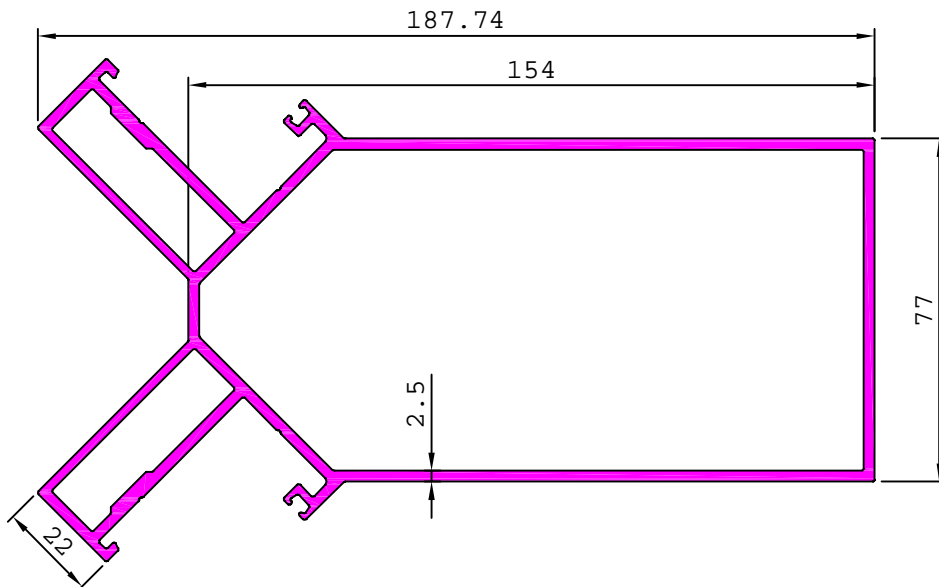

# CURTAIN WALL SECTION-AI

35875

2.594 kg/m

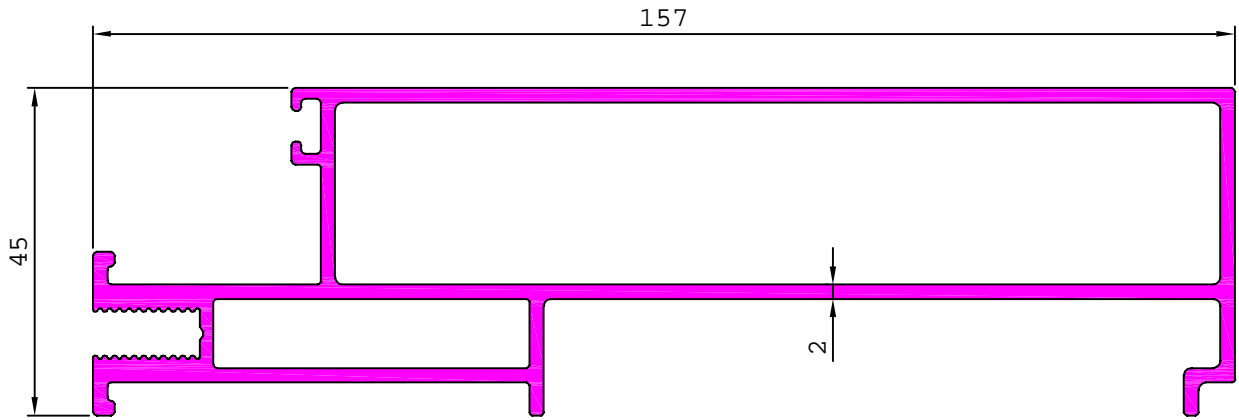

35661

1.030 kg/m

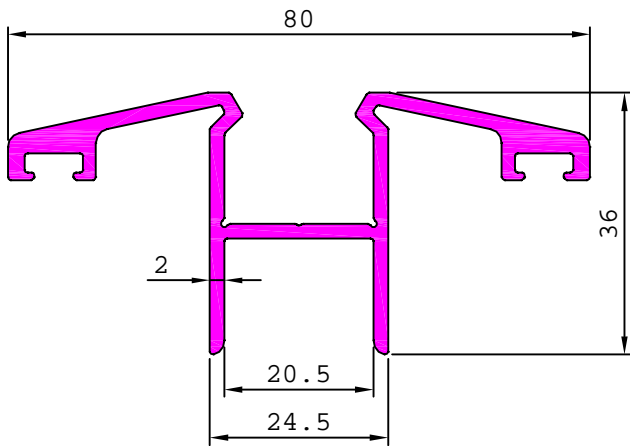

35659

1.813 kg/m

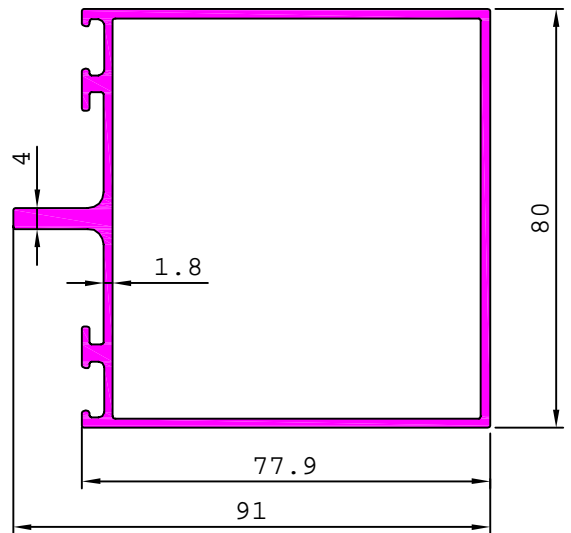

35756

1.291 kg/m

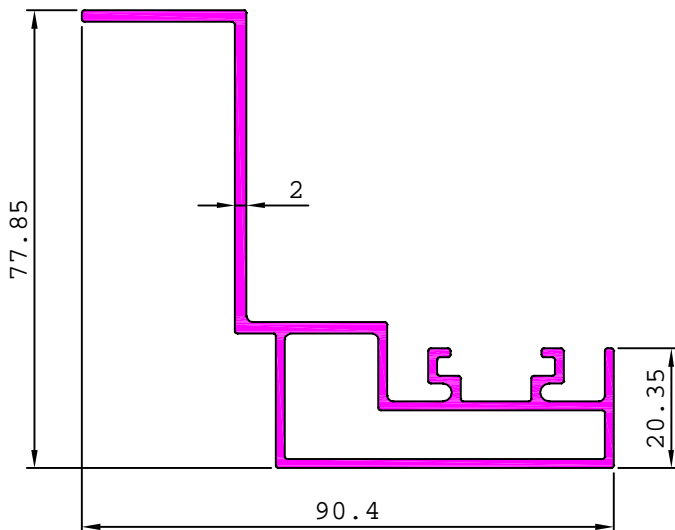

35758

1.653 kg/m

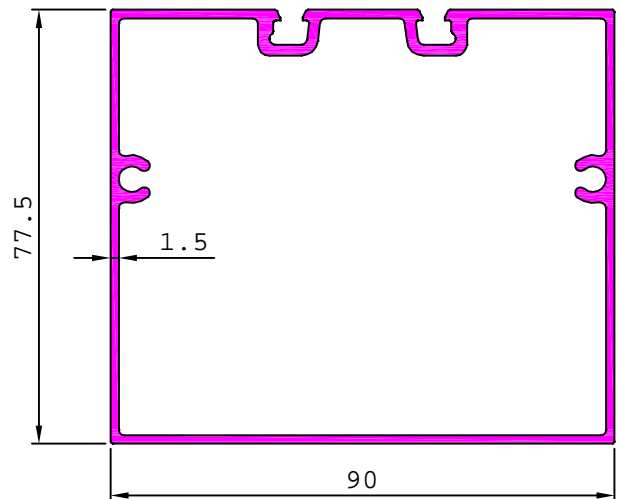

# CURTAIN WALL SECTION-AJ

35676

5.021 kg/m

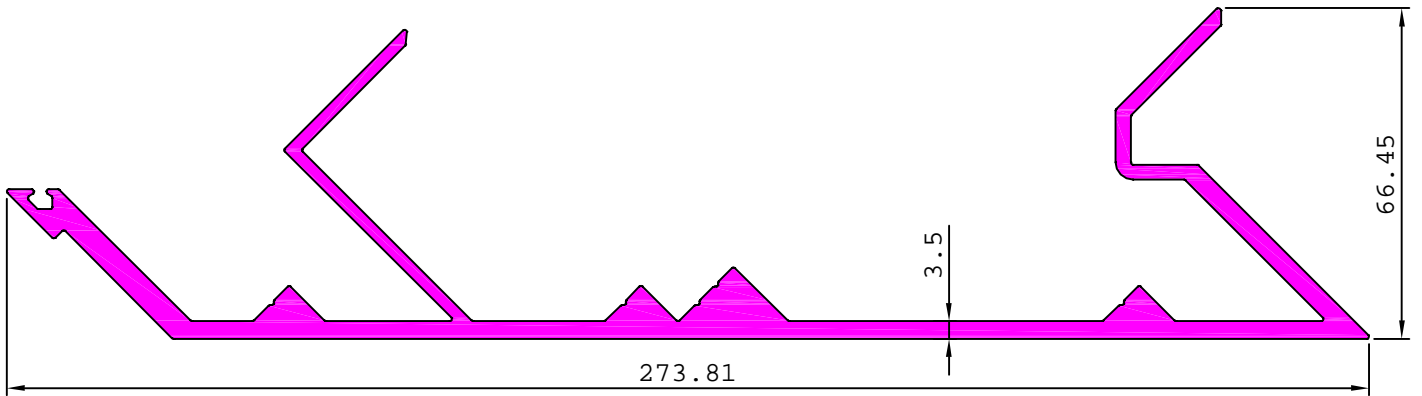

35894

5.124 kg/m

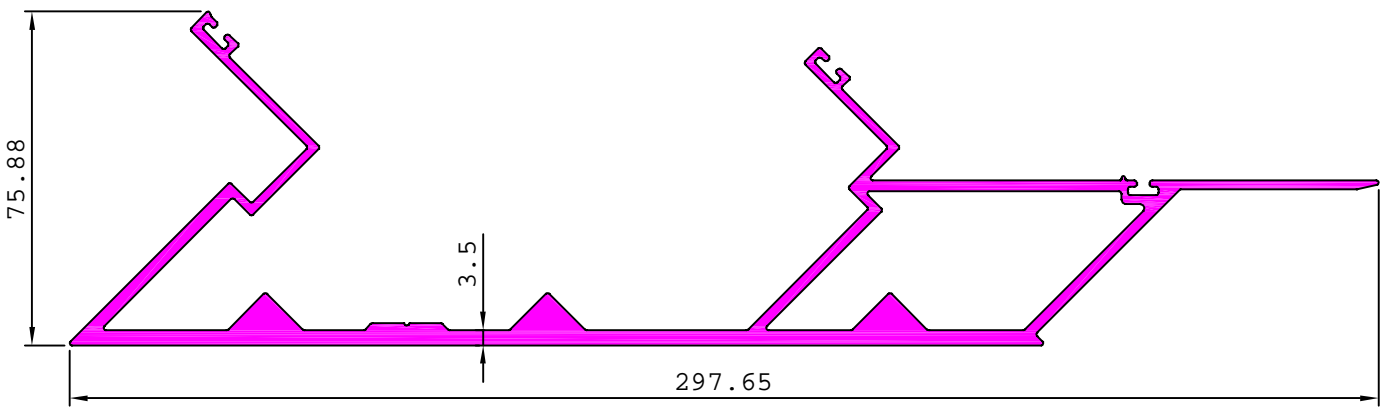

35677

4.405 kg/m

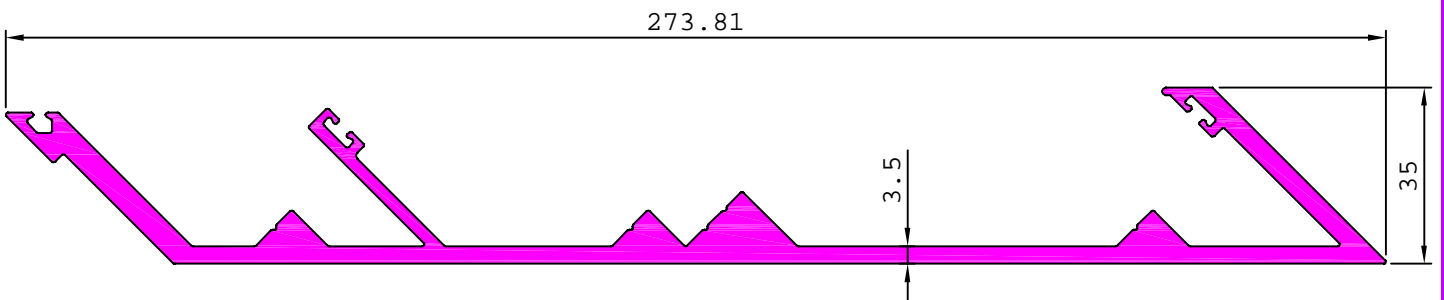

35674

0.882 kg/m

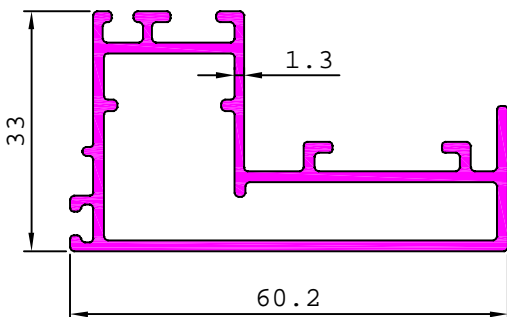

35675

0.659 kg/m

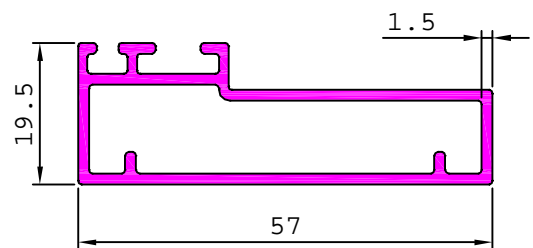

## CURTAIN WALL SECTION-AJ

35683

0.314 kg/m

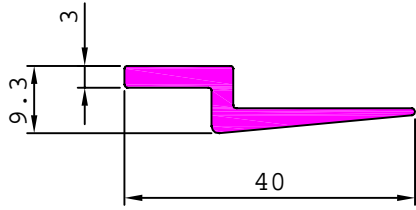

35792

0.487 kg/m

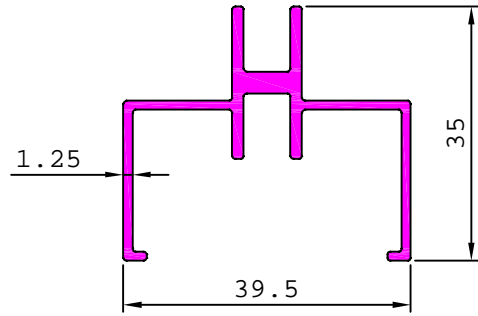

35698

0.280 kg/m

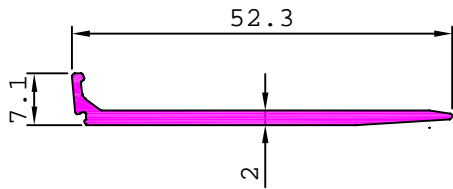

35699

0.237 kg/m

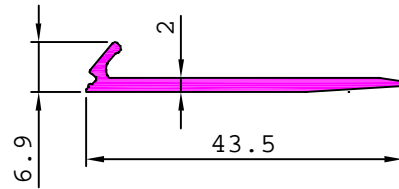

35701

5.280 kg/m

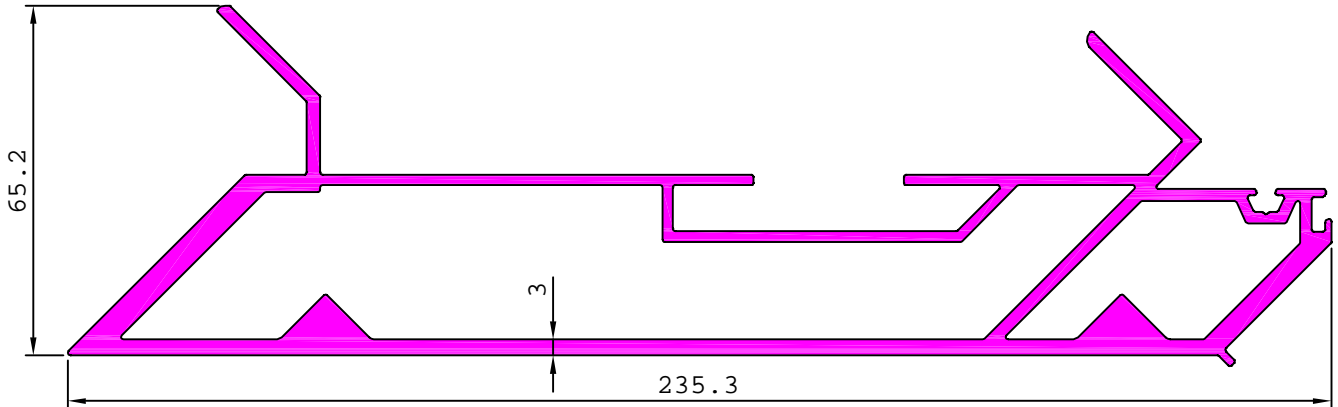

35703

5.391 kg/m

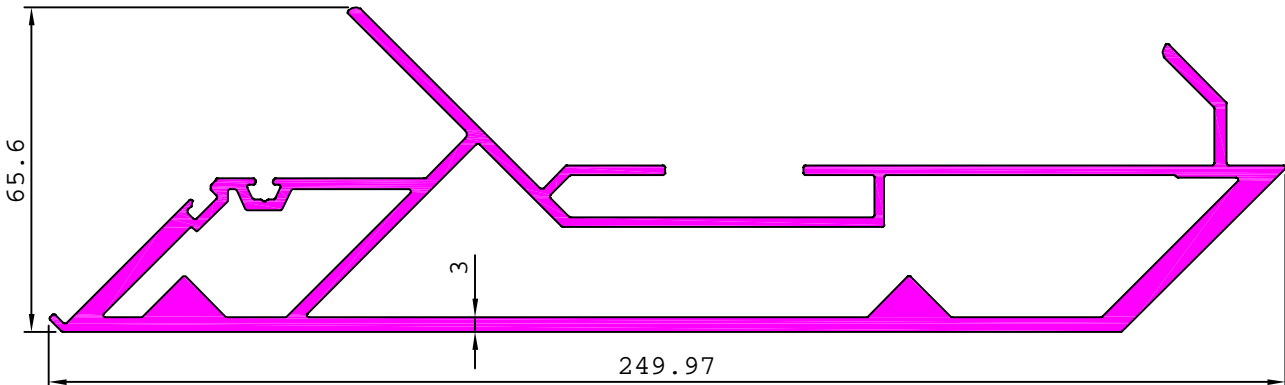

## CURTAIN WALL SECTION-AJ

35700

5.121 kg/m

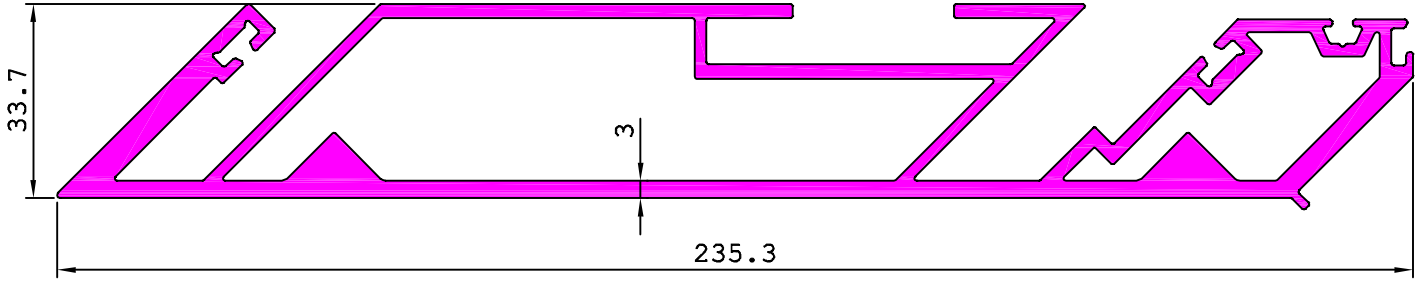

35702

5.047 kg/m

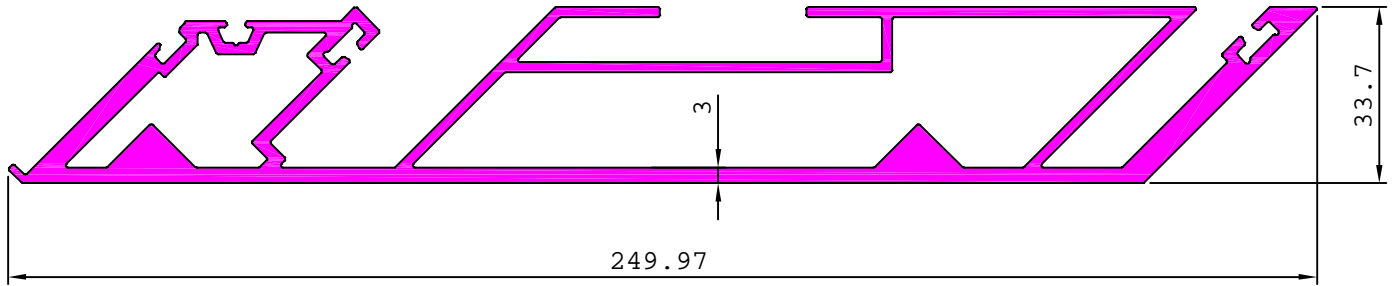

35753

0.551 kg/m

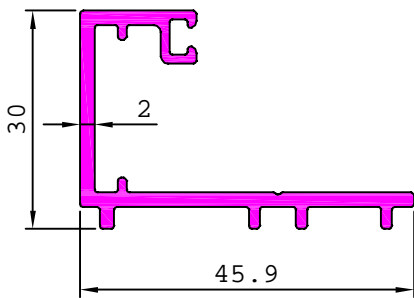

35754

0.496 kg/m

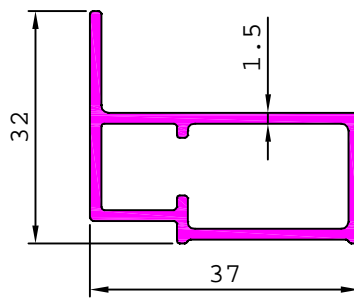

35755

0.239 kg/m

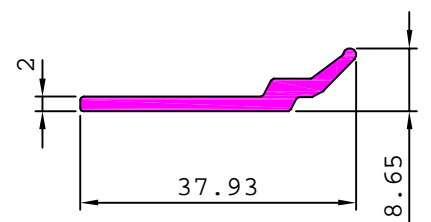

35759

1.824 kg/m

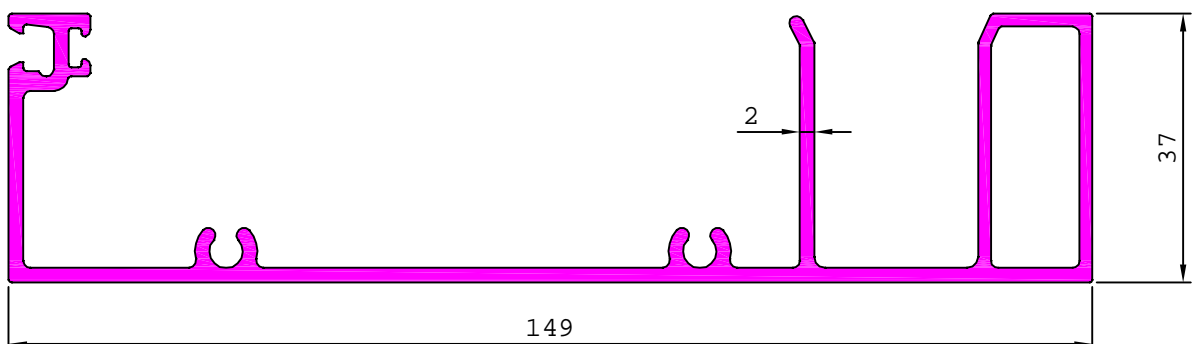

## CURTAIN WALL SECTION-AJ

35762

2.131 kg/m

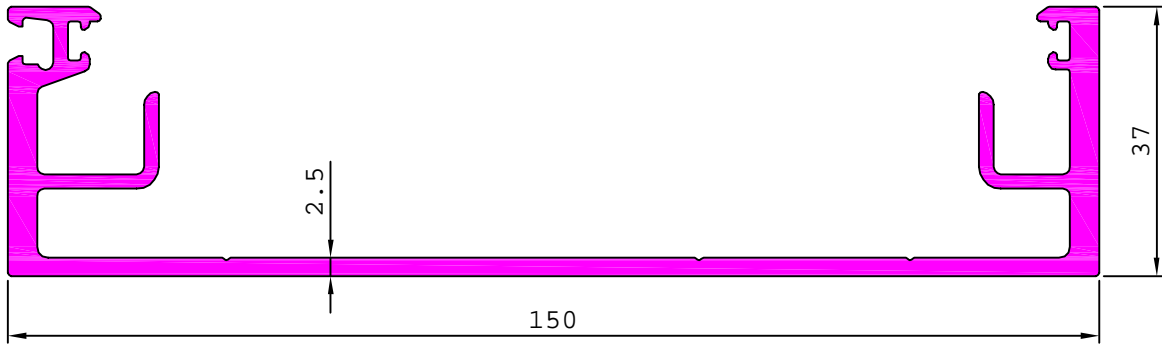

35761

2.411 kg/m

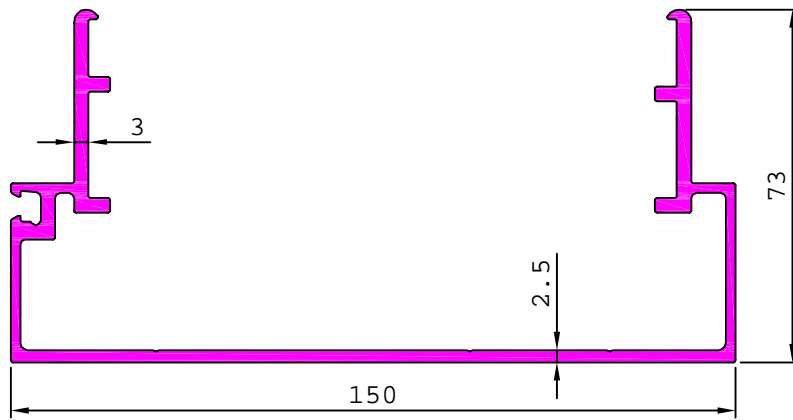

35757

3.703 kg/m

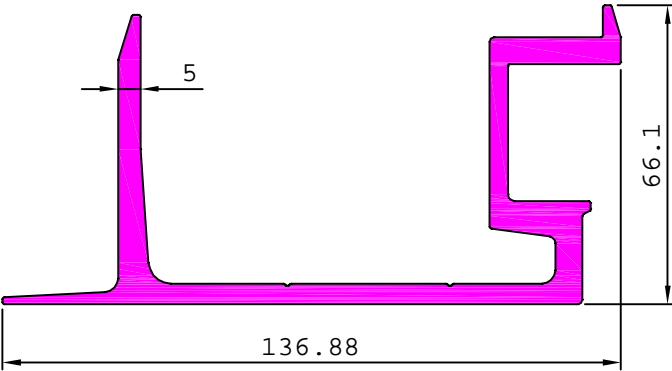

35841

0.433 kg/m

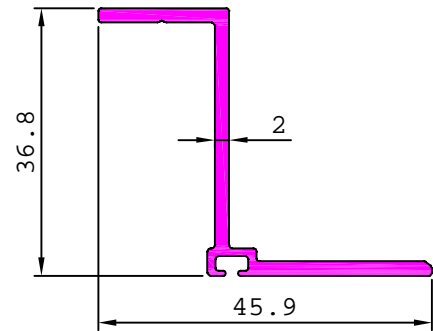

35790

0.714 kg/m

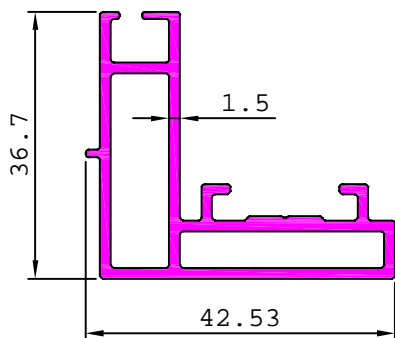

35791

0.478 kg/m

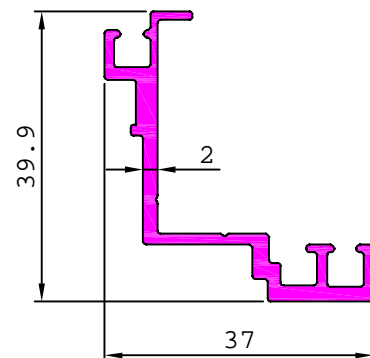

## CURTAIN WALL SECTION

35877 0.969 kg/m

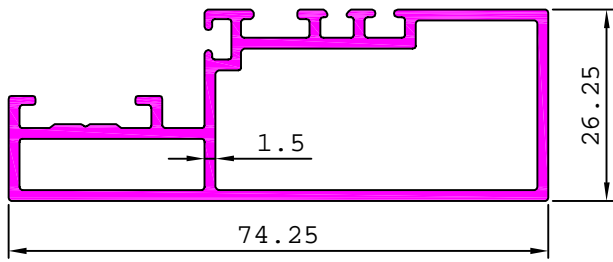

35869 0.648 kg/m

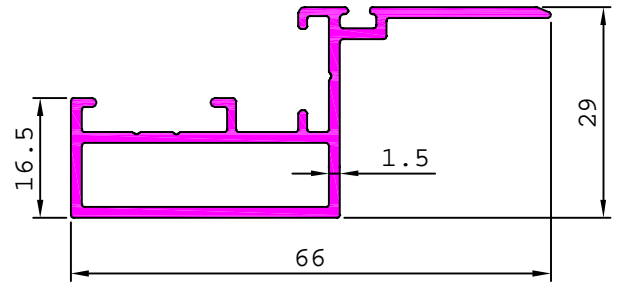

MATCHING WITH 35878,35879

35876 2.621 kg/m

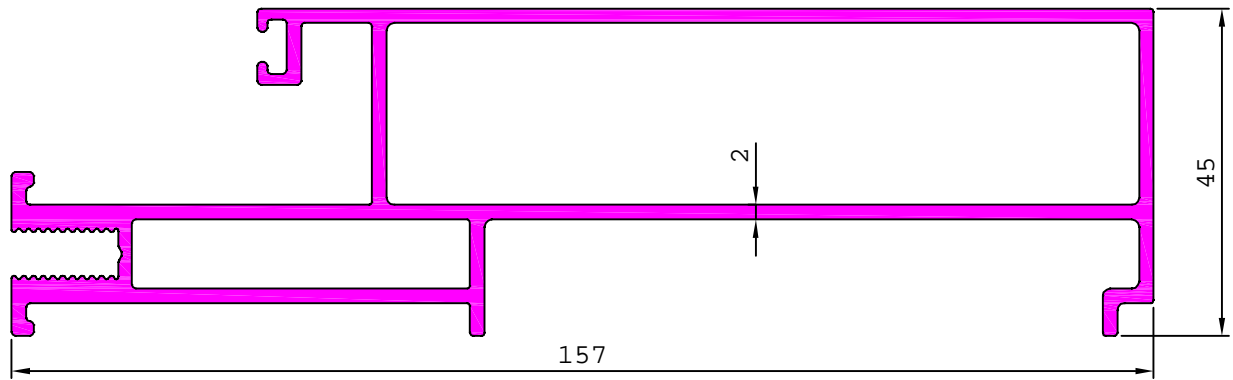

35852 5.641 kg/m

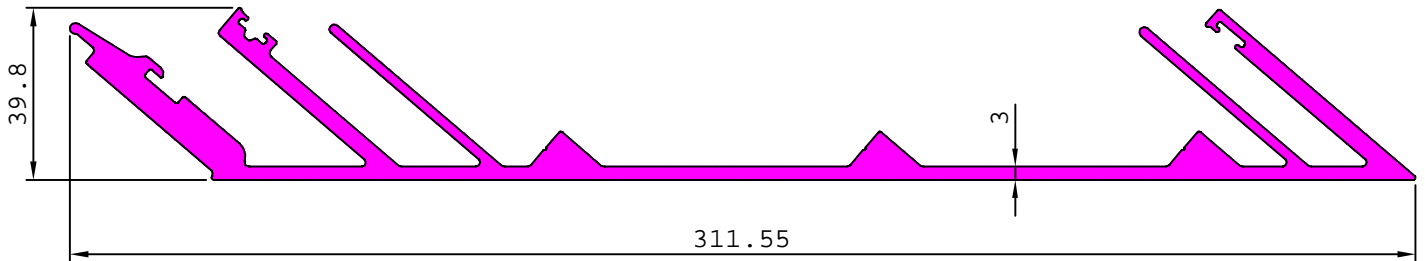

35867 3.709 kg/m

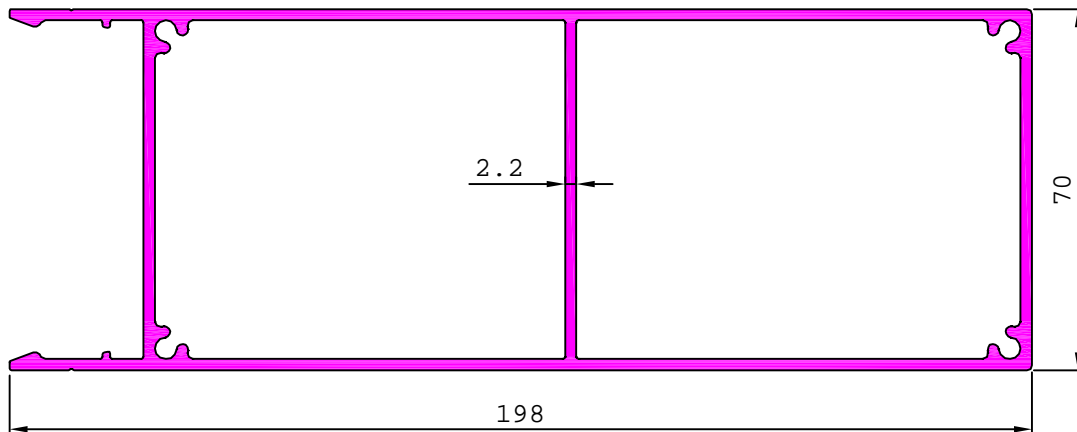

MATCHING WITH 35980

## CURTAIN WALL SECTION

35914

0.372 kg/m

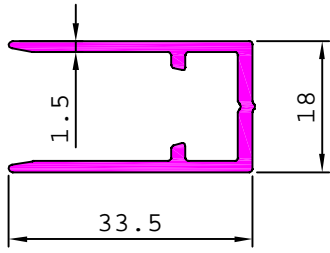

35874

0.818 kg/m

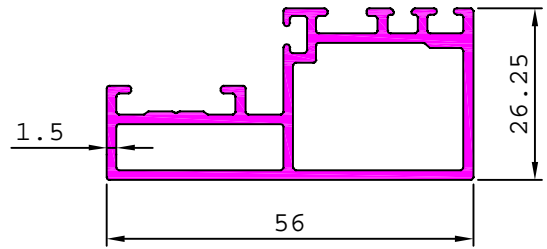

MATCHING WITH 35878,35879

35902

0.855 kg/m

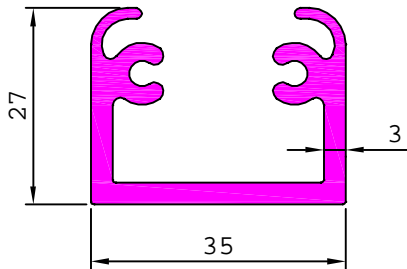

35911

0.351 kg/m

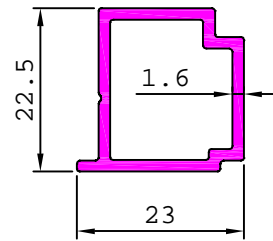

35825

0.588 kg/m

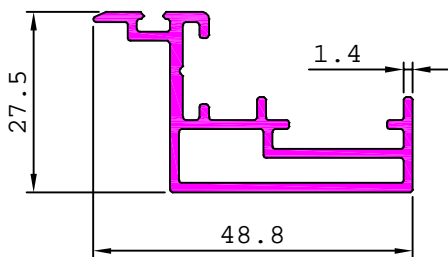

35827

0.575 kg/m

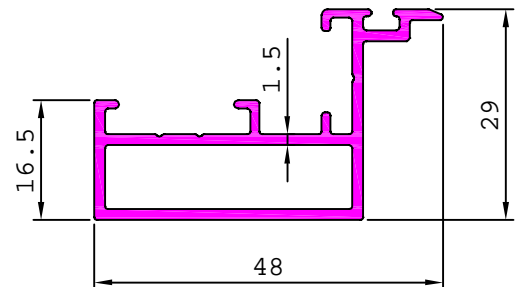

35829

0.583 kg/m

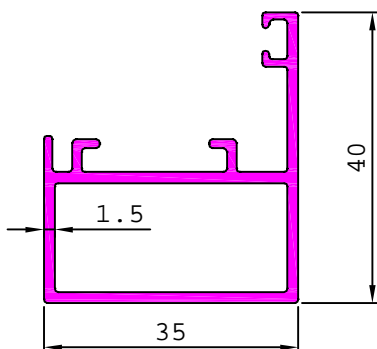

35828

0.443 kg/m

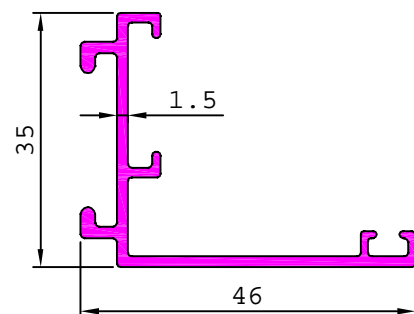

## CURTAIN WALL SECTION

35832

0.207 kg/m

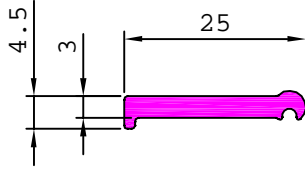

35860

0.834 kg/m

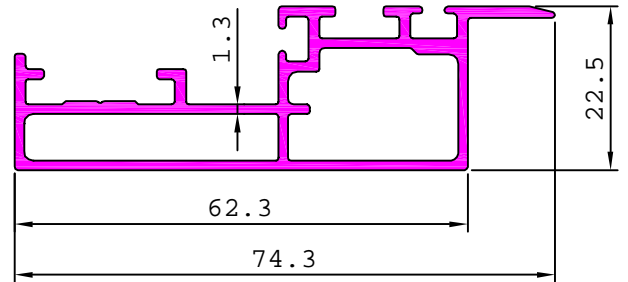

35838

1.500 kg/m

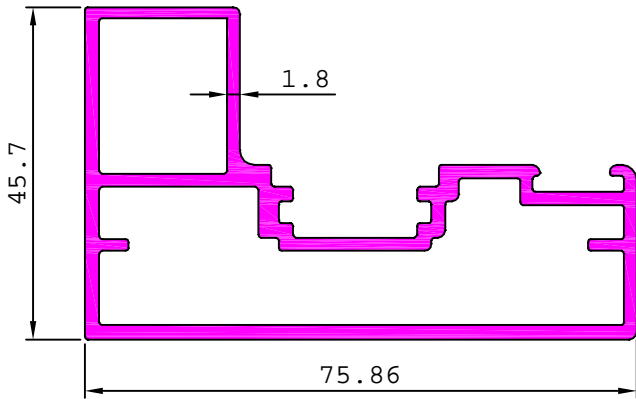

35839

1.434 kg/m

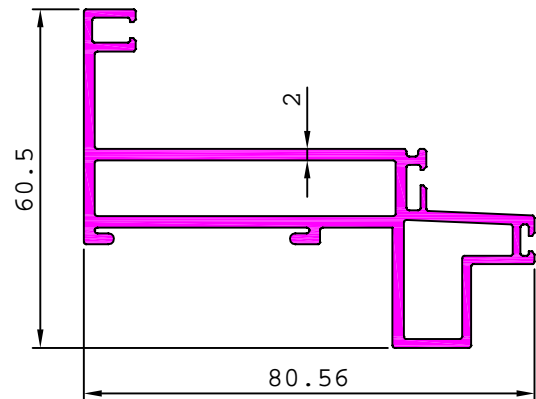

35830

2.127 kg/m

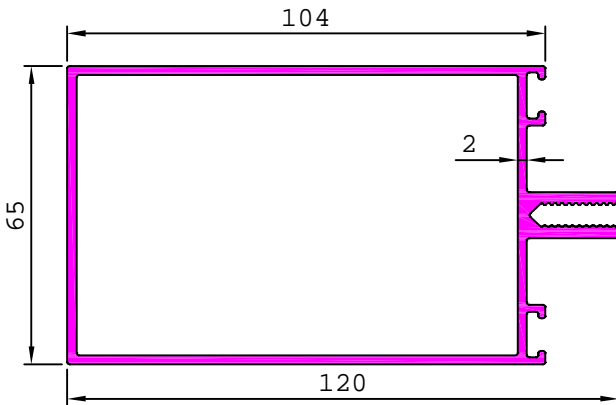

35831

2.083 kg/m

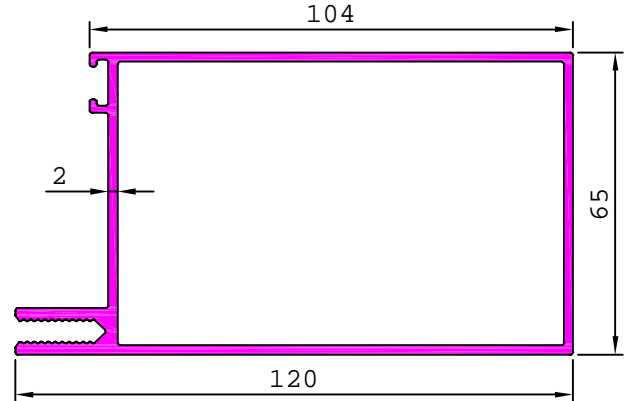

36103

0.168 kg/m

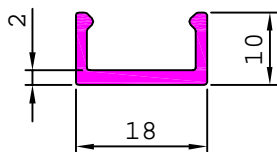

21082

0.662 kg/m

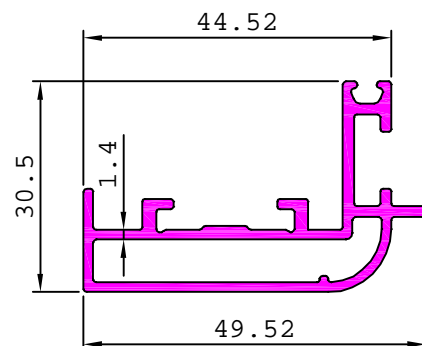

MATCHING WITH S5683

# CURTAIN WALL SECTION

35906

4.262 kg/m

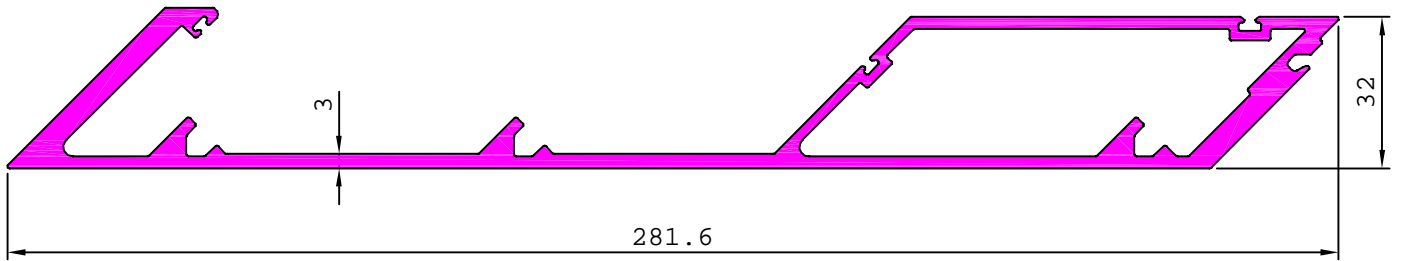

35907

4.785 kg/m

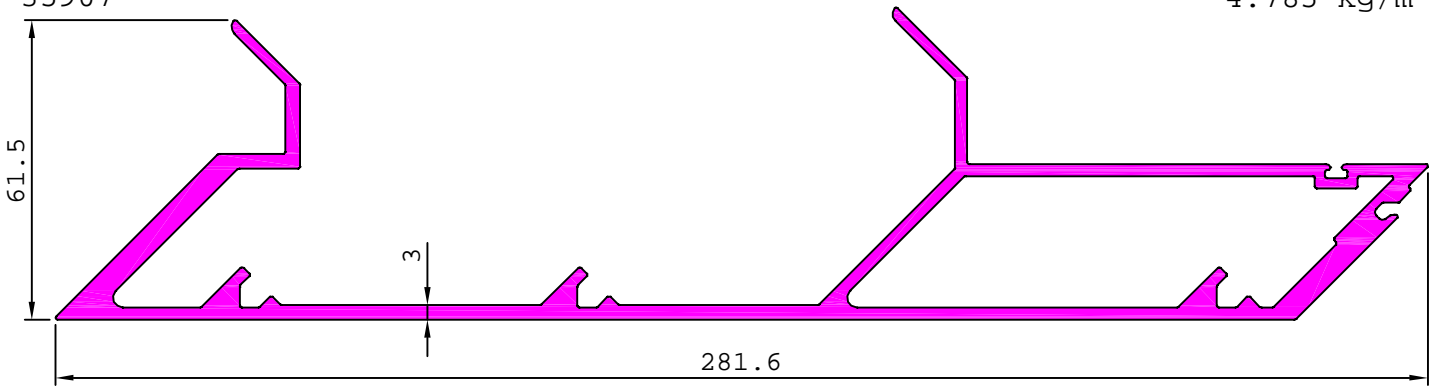

35908

3.247 kg/m

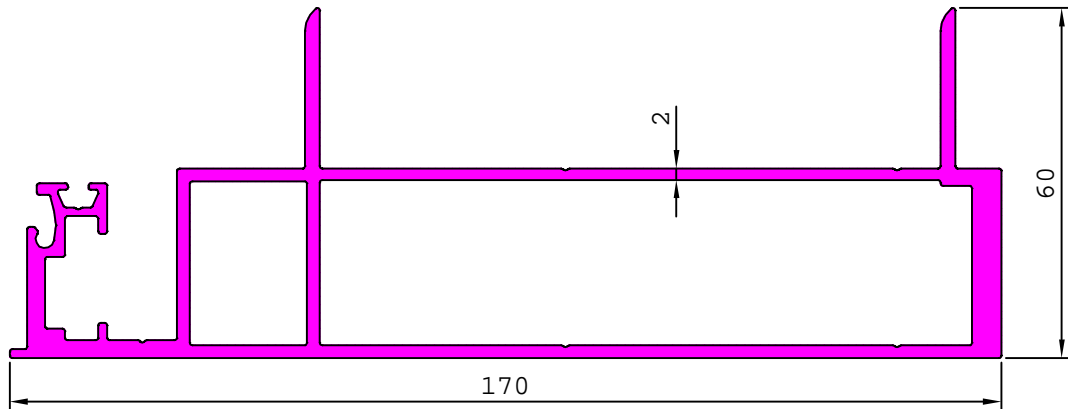

35910

2.936 kg/m

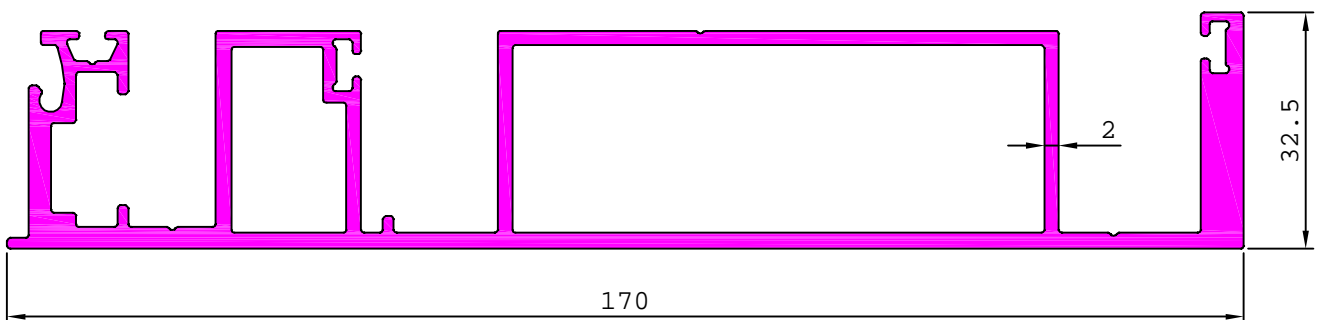

## CURTAIN WALL SECTION

35909

0.179 kg/m

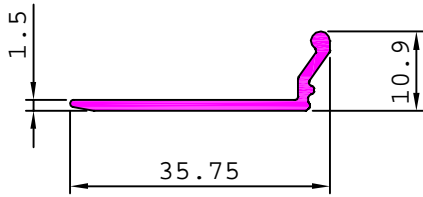

MATCHING WITH 35908,35910,35912,35915

35913

1.491 kg/m

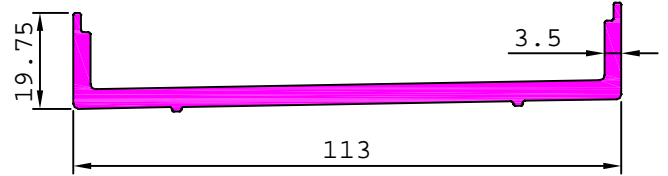

35915

2.925 kg/m

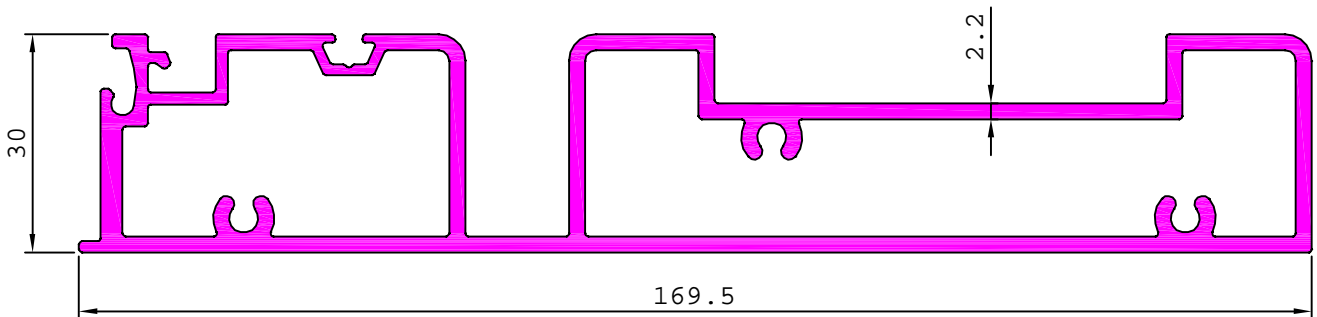

35897

2.754 kg/m

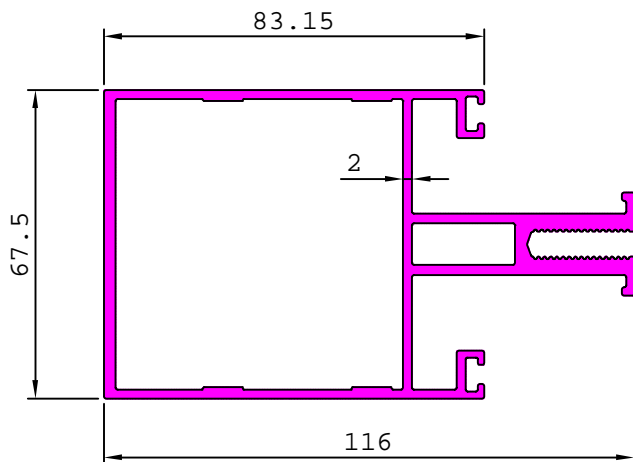

35900

0.938 kg/m

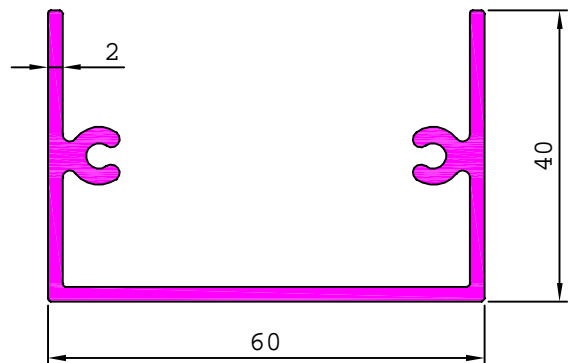

### CURTAIN WALL SECTION

35912

3.870 kg/m

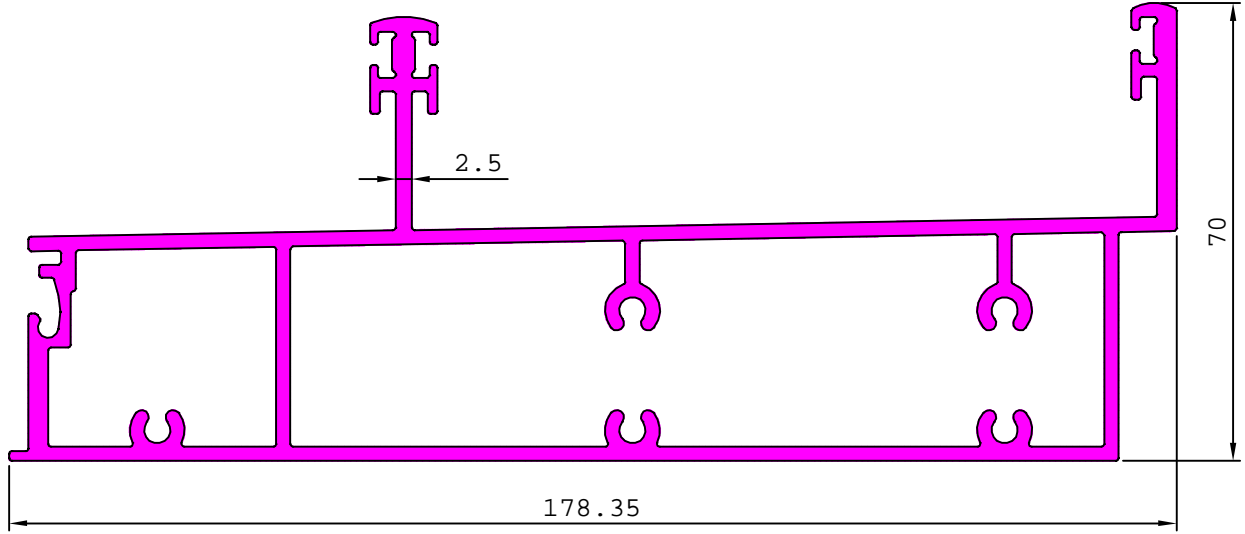

35893

4.210 kg/m

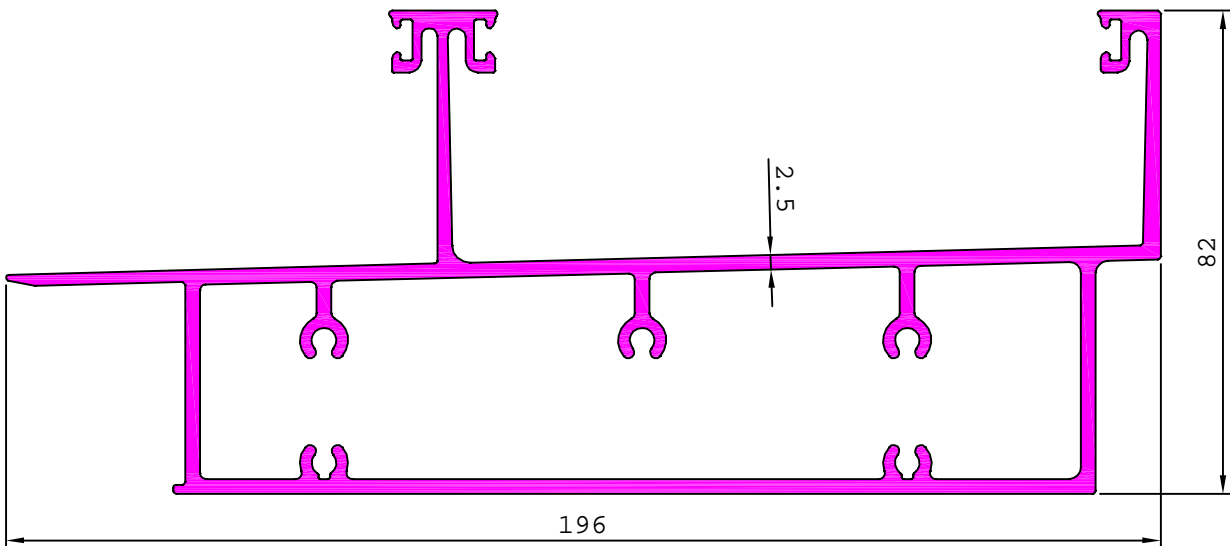

## CURTAIN WALL SECTION

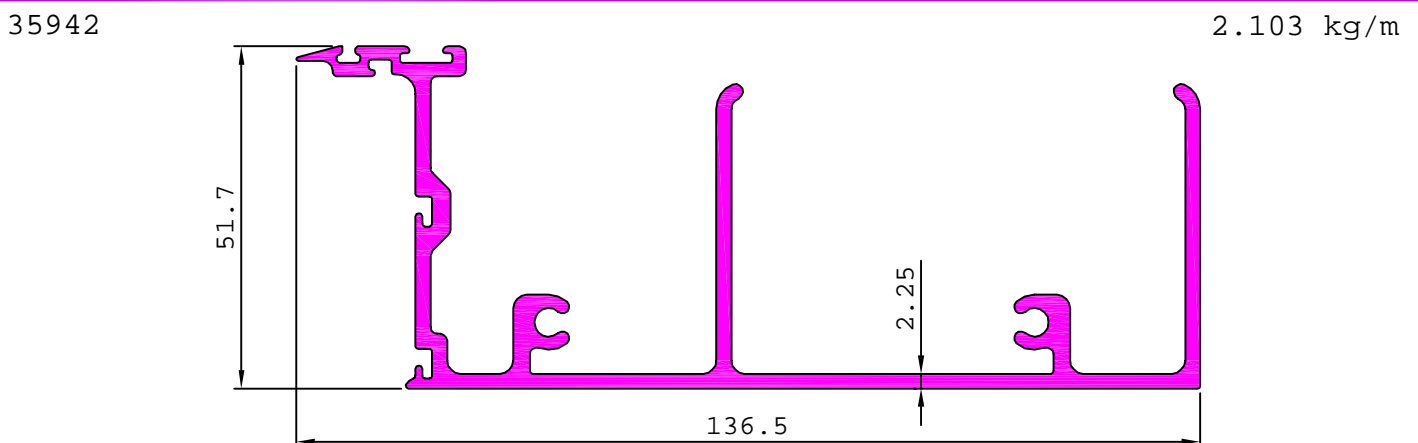
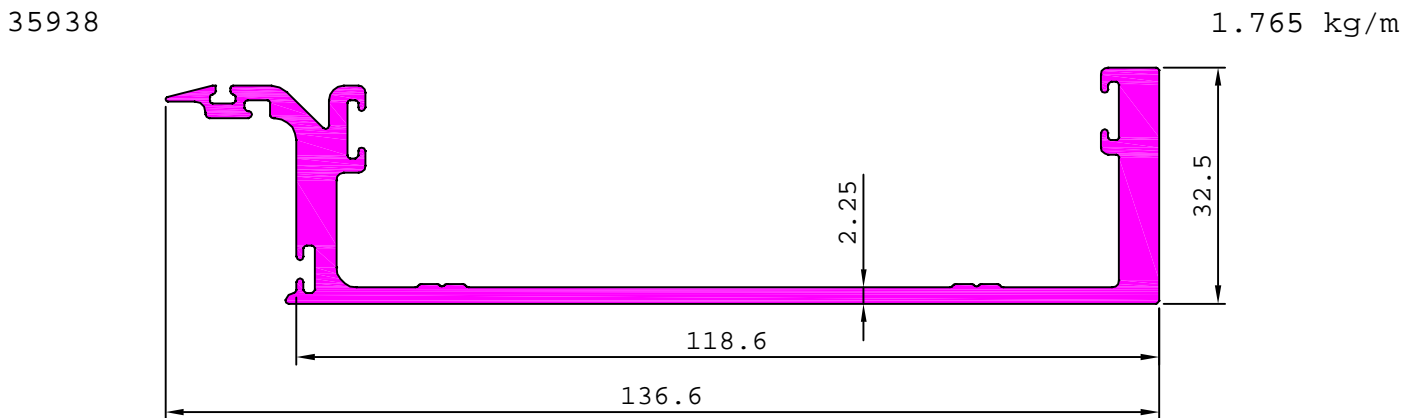
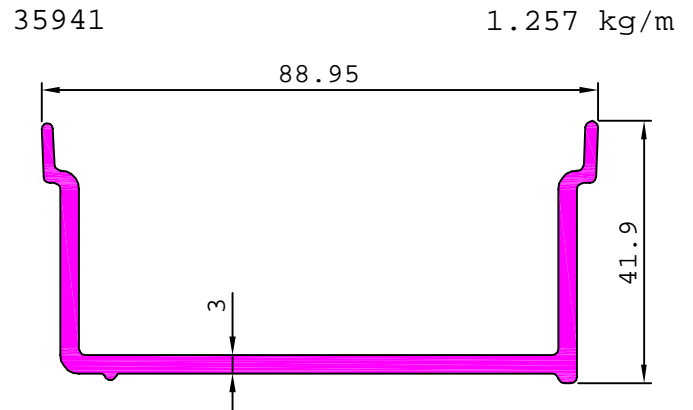
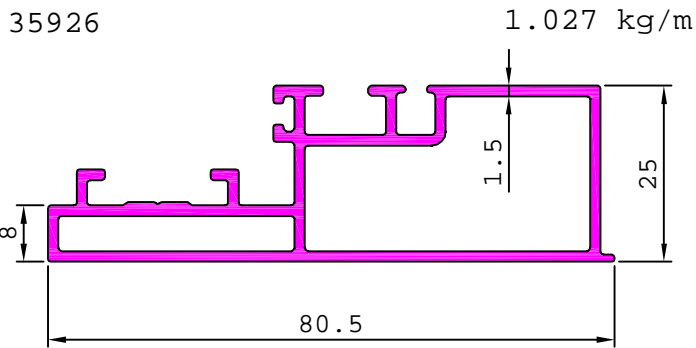
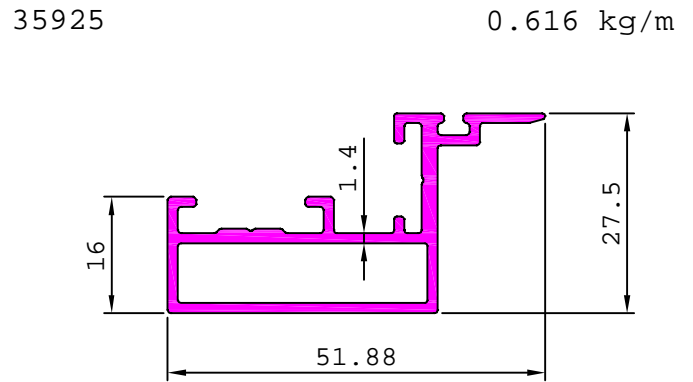
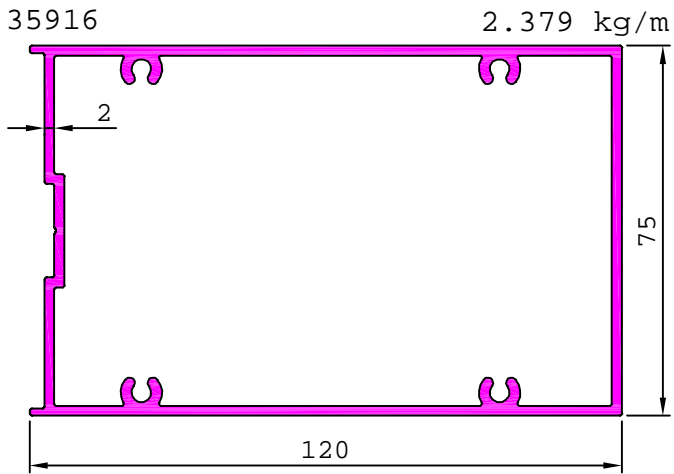

## CURTAIN WALL SECTION

G100761

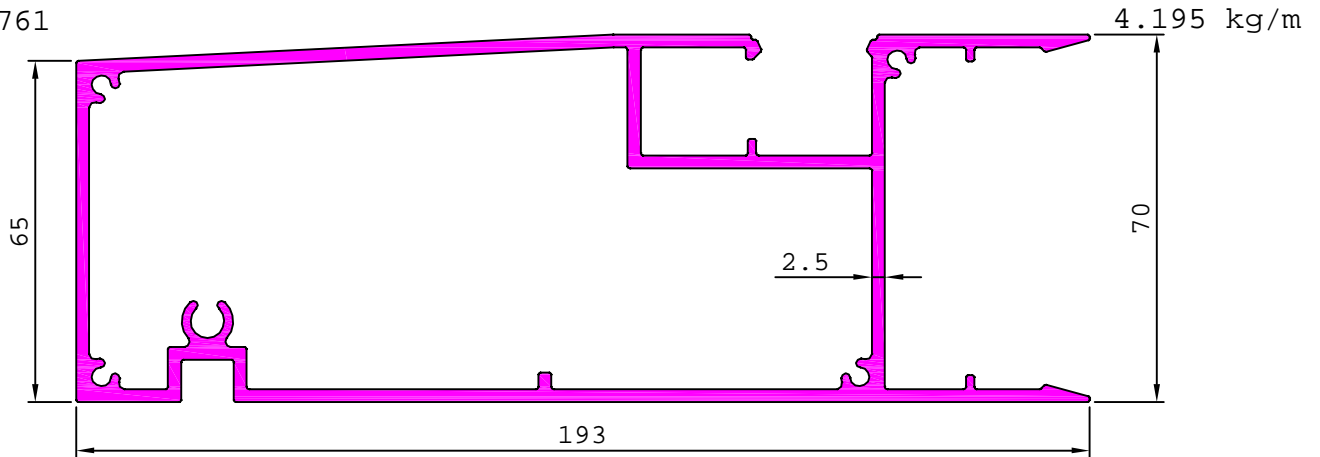

MATCHING WITH G100762,G100763

G100762

0.656 kg/m

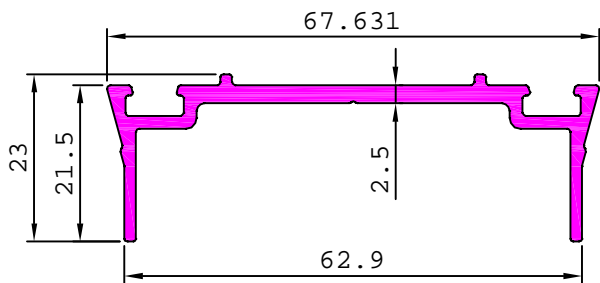

MATCHING WITH G100761

G100993

1.394 kg/m

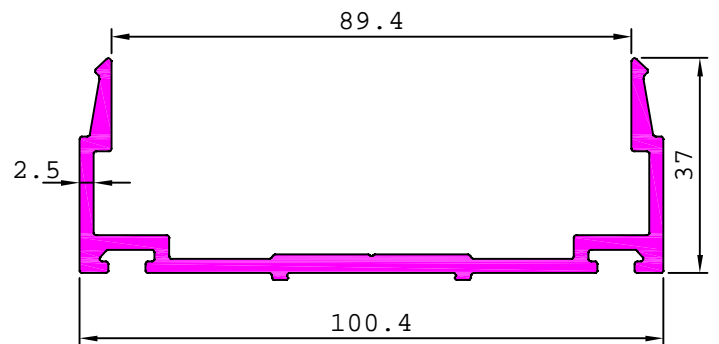

MATCHING WITH G100991

G101440

0.723 kg/m

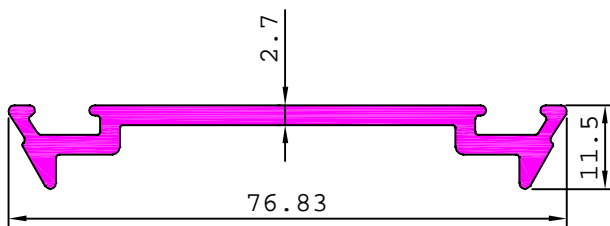

MATCHING WITH G101433

G101743

0.402 kg/m

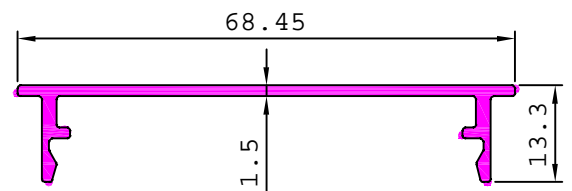

MATCHING WITH G101744,G101742.

G100882

0.353 kg/m

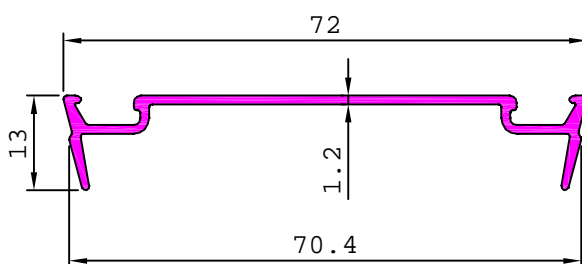

MATCHING WITH G100881

G100771

0.653 kg/m

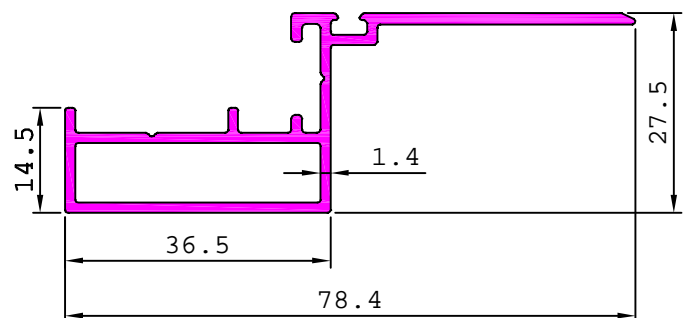

## CURTAIN WALL SECTION

G100895

0.993 kg/m

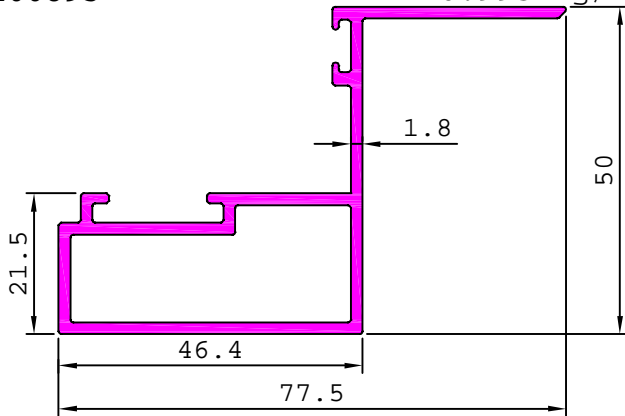

G100965

0.798 kg/m

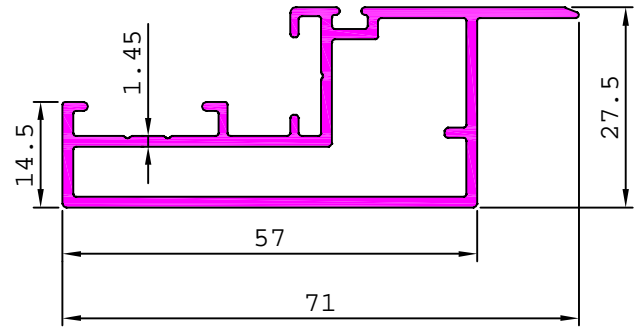

G100894

1.230 kg/m

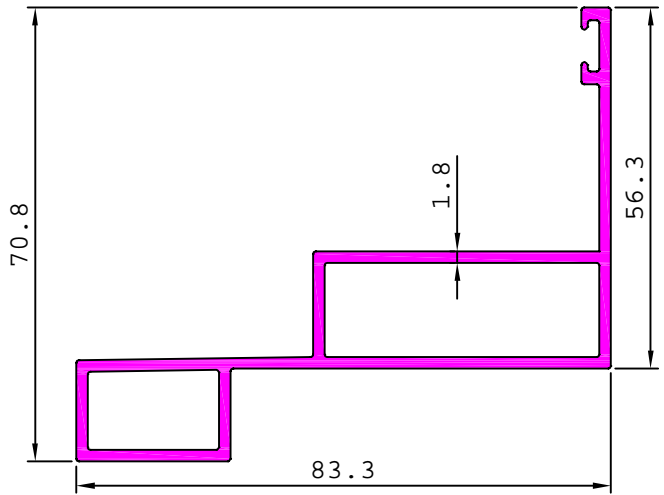

G100897

0.968 kg/m

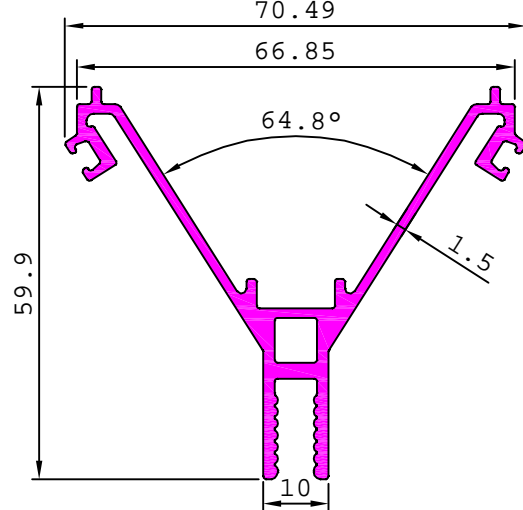

G100966

0.790 kg/m

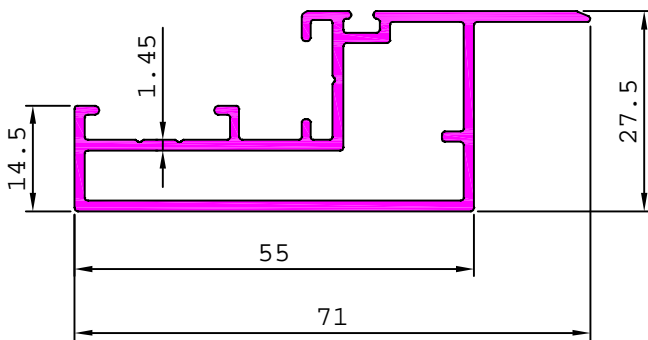

G100967

0.783 kg/m

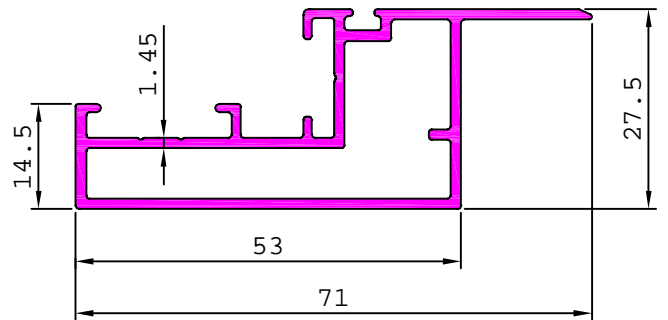

G100964

0.675 kg/m

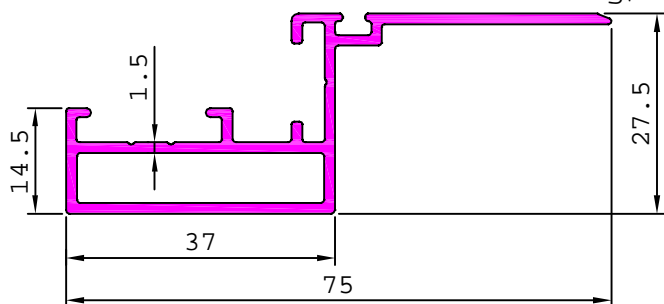

G100992

0.674 kg/m

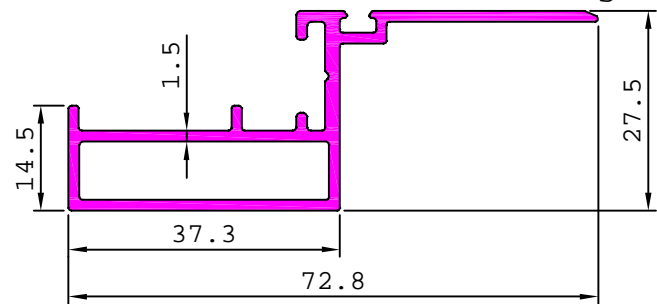

## CURTAIN WALL SECTION

G100990

0.984 kg/m

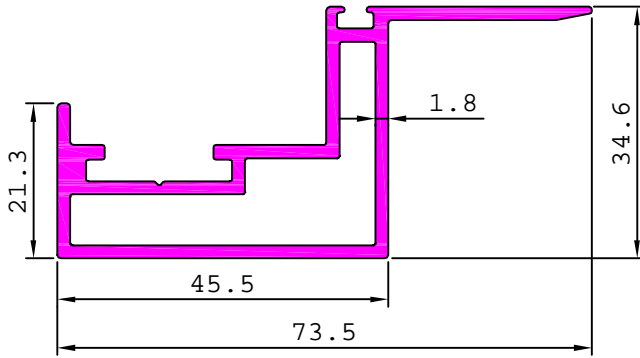

G101111

1.125 kg/m

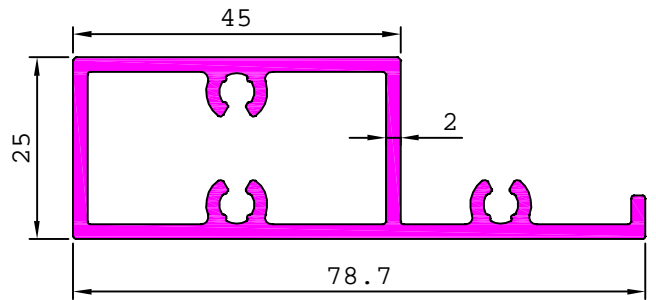

G100991

2.238 kg/m

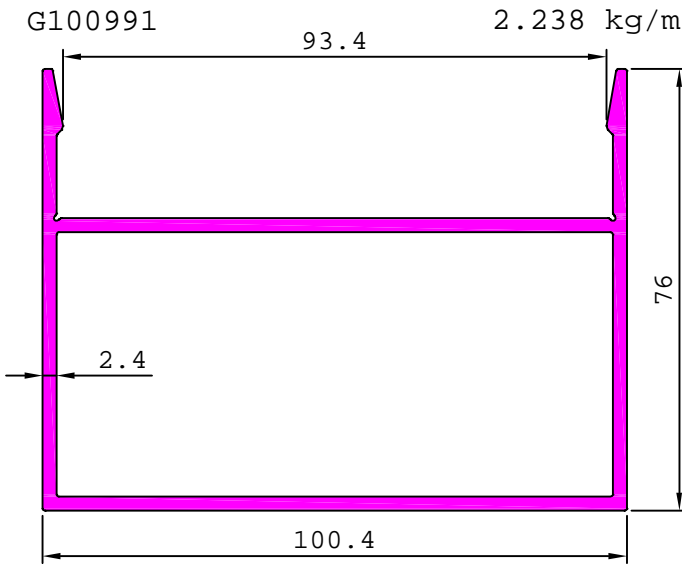

MATCHING WITH G100993

G101102

1.362 kg/m

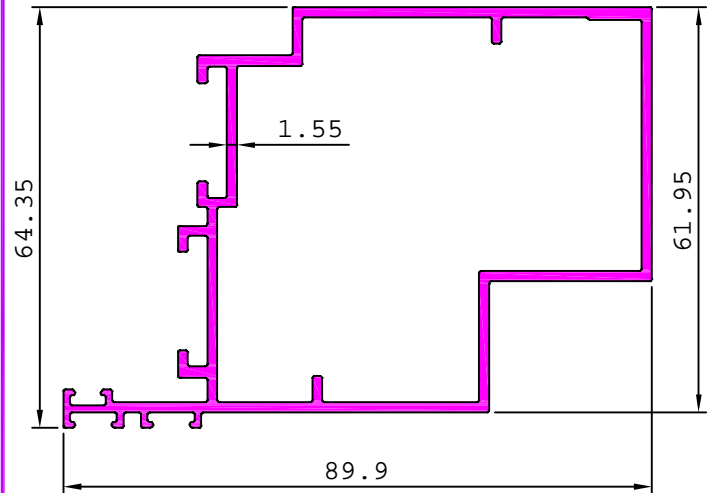

G101264

0.853 kg/m

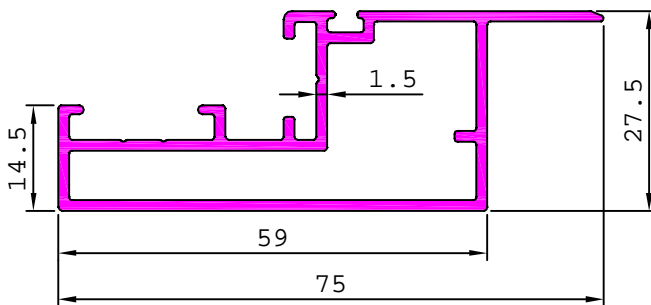

G101265

0.845 kg/m

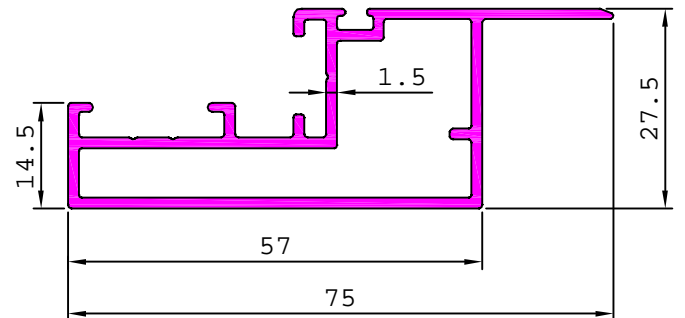

G101758

1.393 kg/m

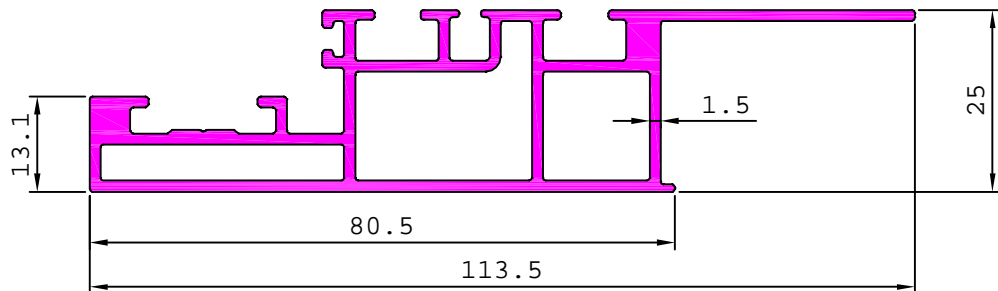

# CURTAIN WALL SECTION

35932

2.617 kg/m

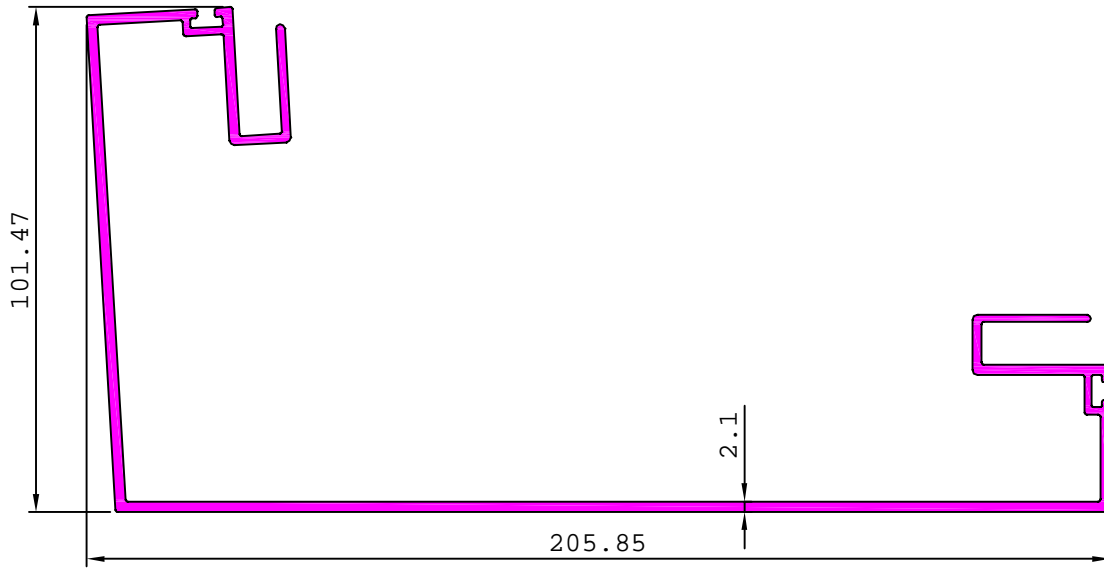

35933

2.597 kg/m

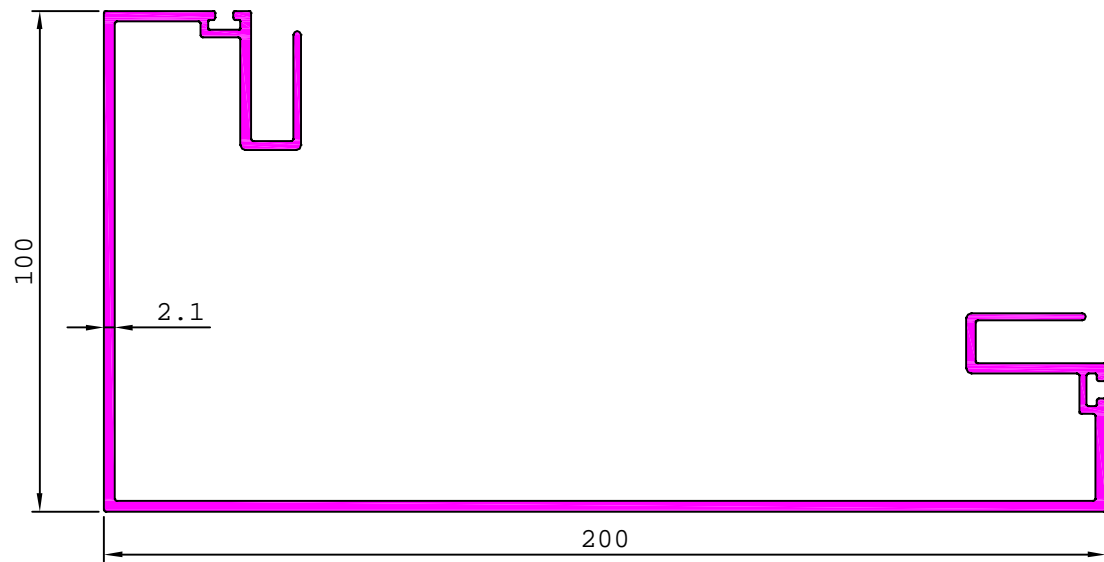

35934

2.685 kg/m

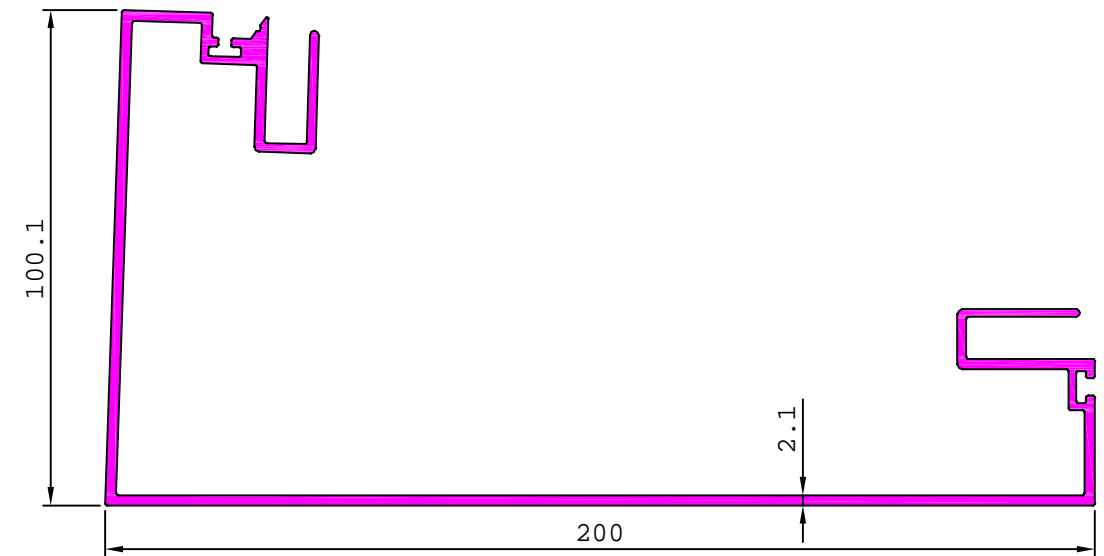

### CURTAIN WALL SECTION

35937

3.359 kg/m

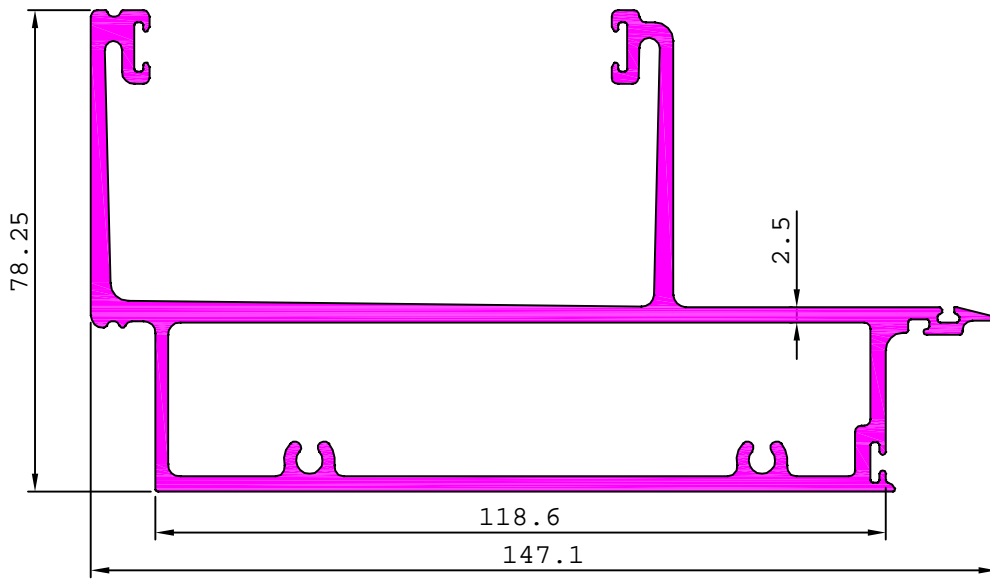

35939

2.866 kg/m

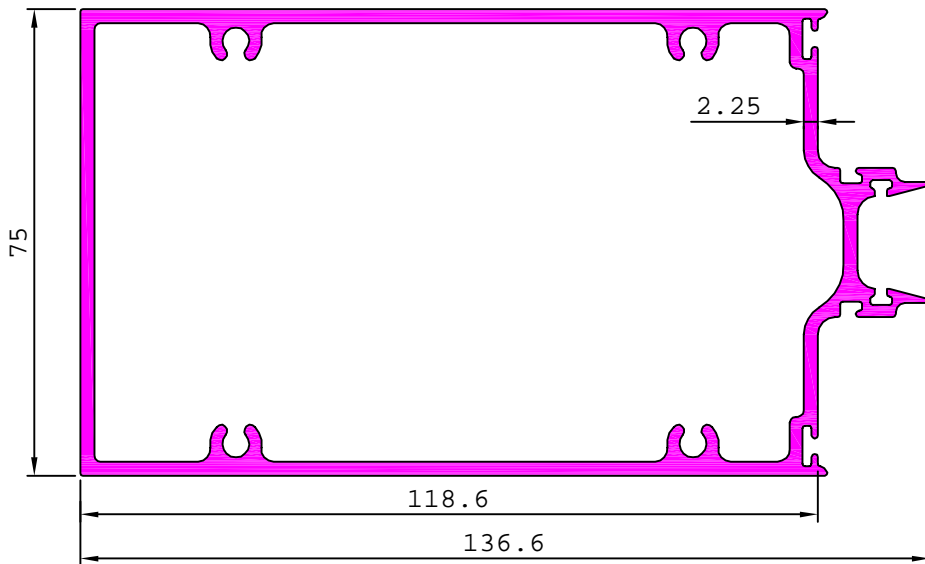

35940

2.161 kg/m

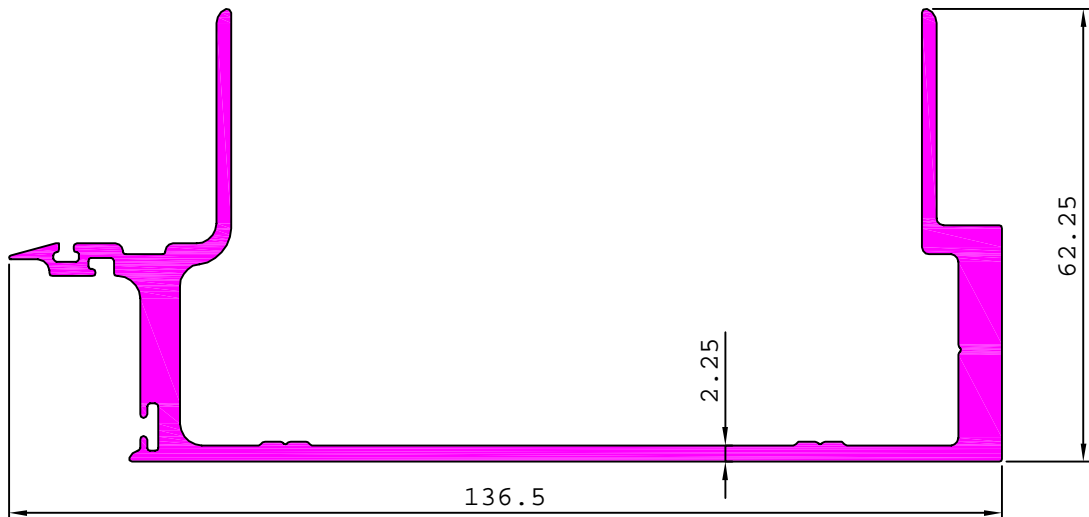

# CURTAIN WALL SECTION

35943

3.205 kg/m

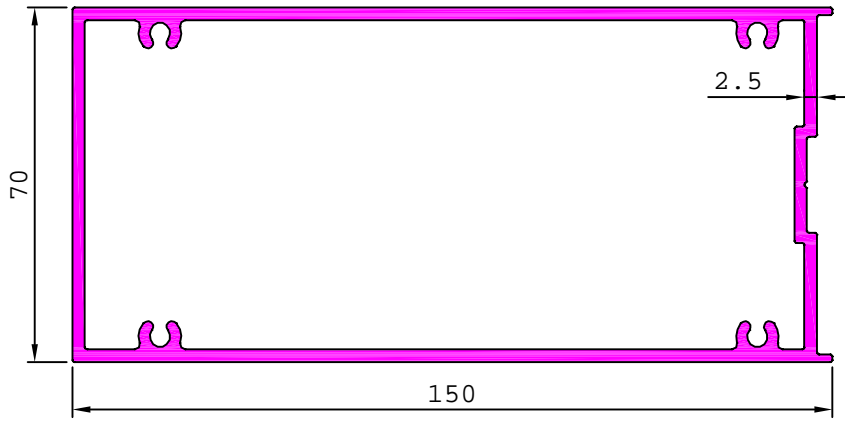

35944

2.717 kg/m

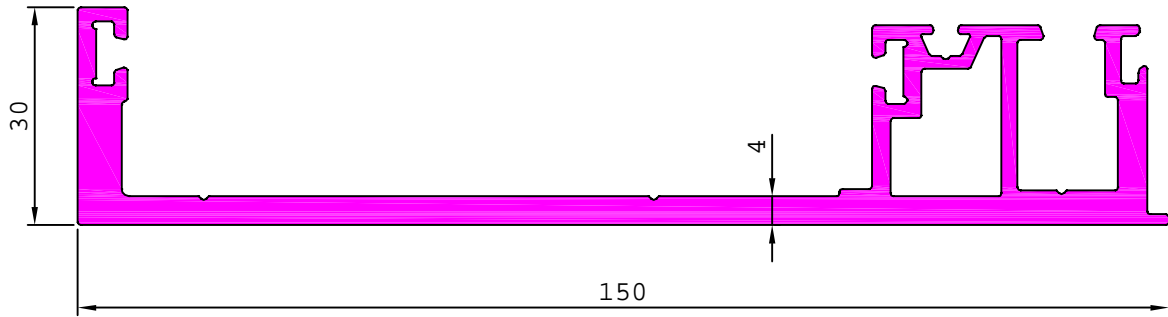

35945

3.693 kg/m

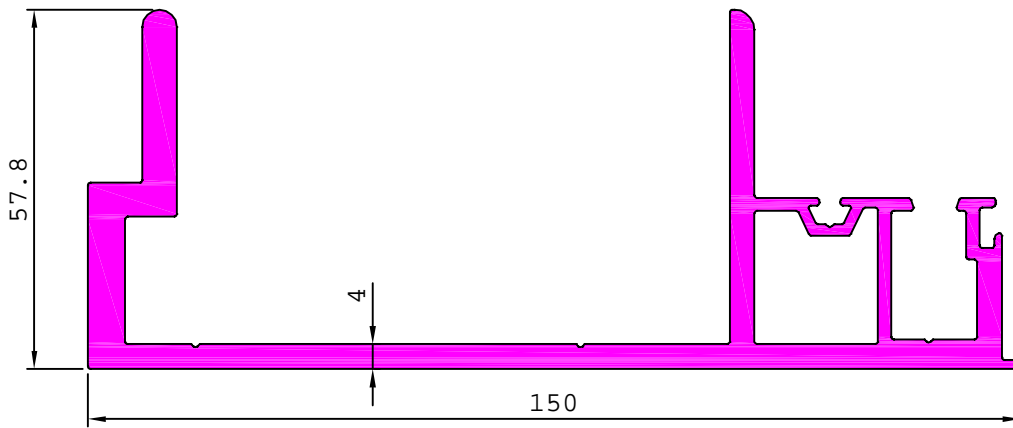

36267

1.625 kg/m

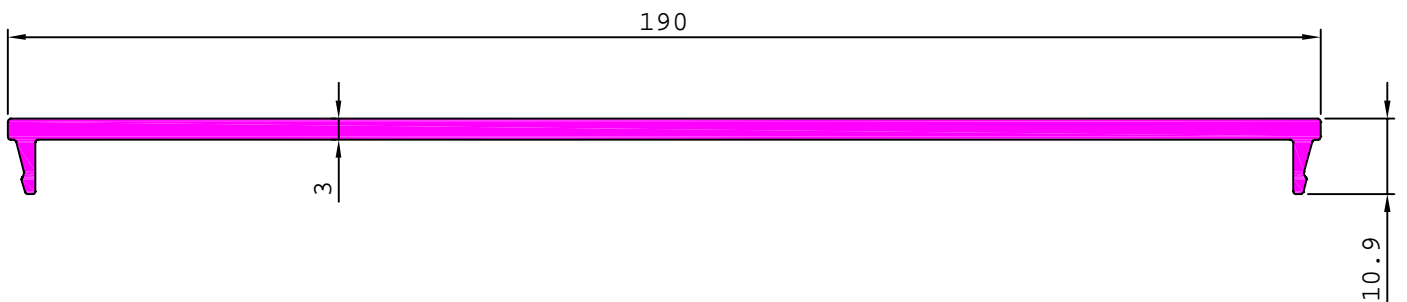

MATCHING WITH 36266

## CURTAIN WALL SECTION

35956 1.813 kg/m

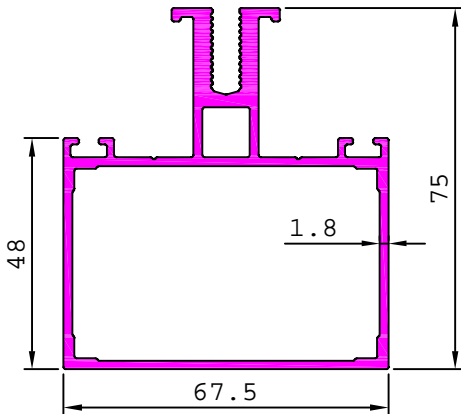

35957 0.921 kg/m

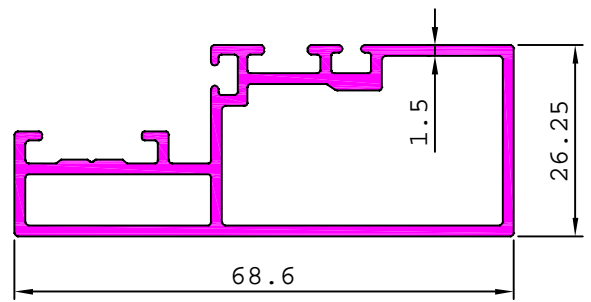

35949 0.848 kg/m

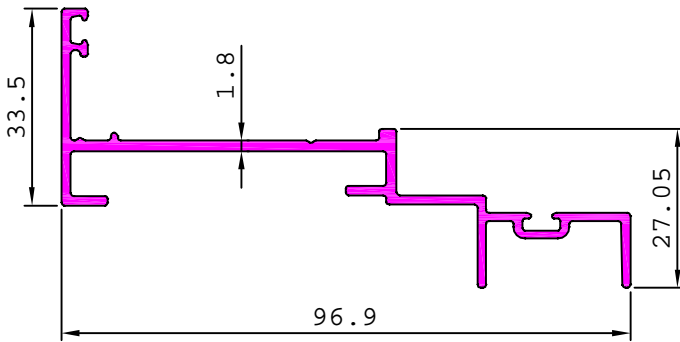

35950 0.956 kg/m

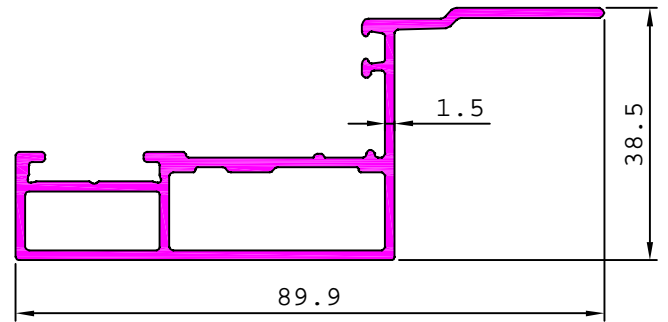

35953 0.753 kg/m

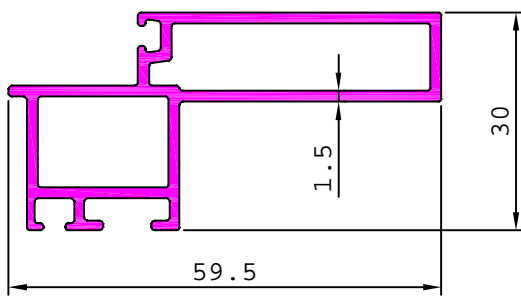

36007 1.141 kg/m

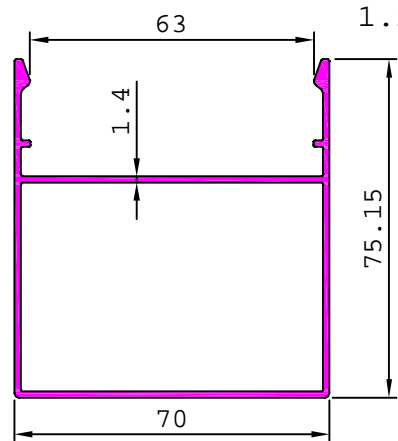

36041 0.774 kg/m

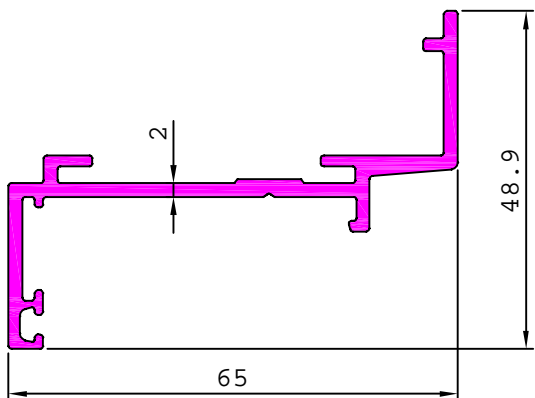

36045 1.357 kg/m

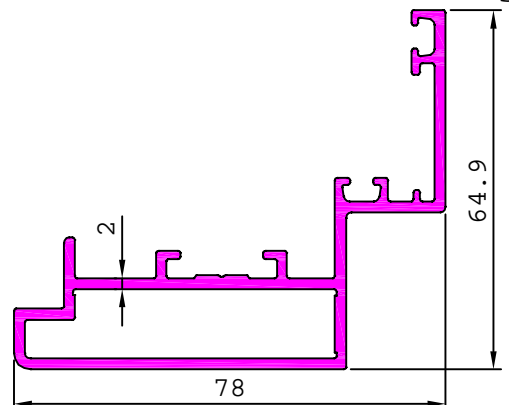

## CURTAIN WALL SECTION

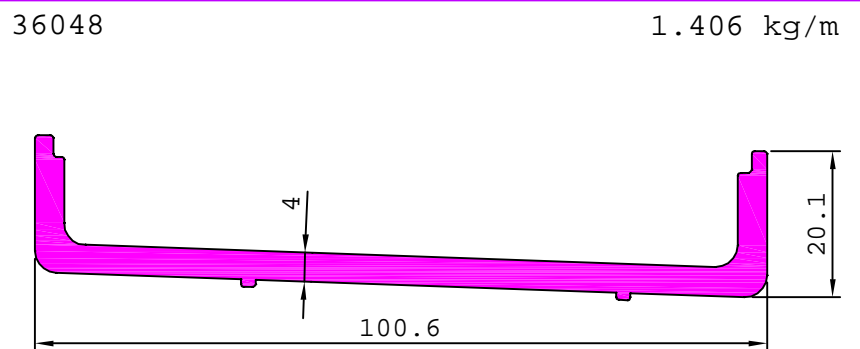
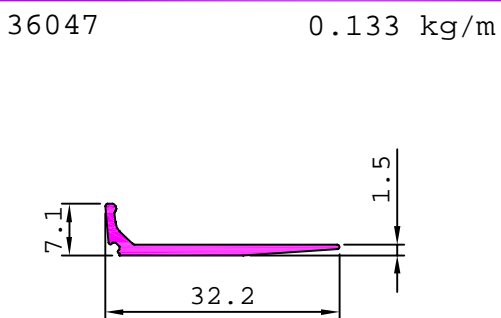
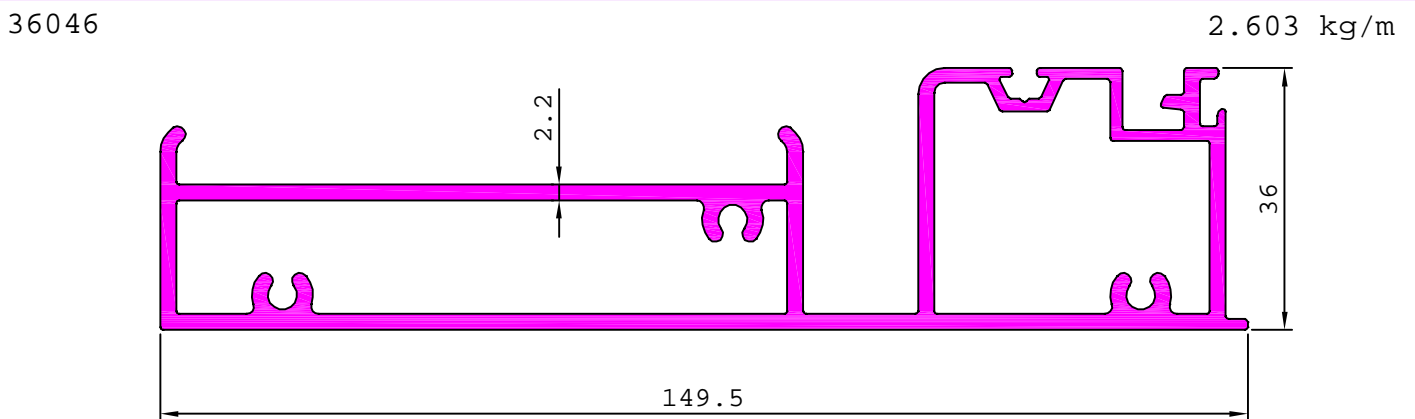
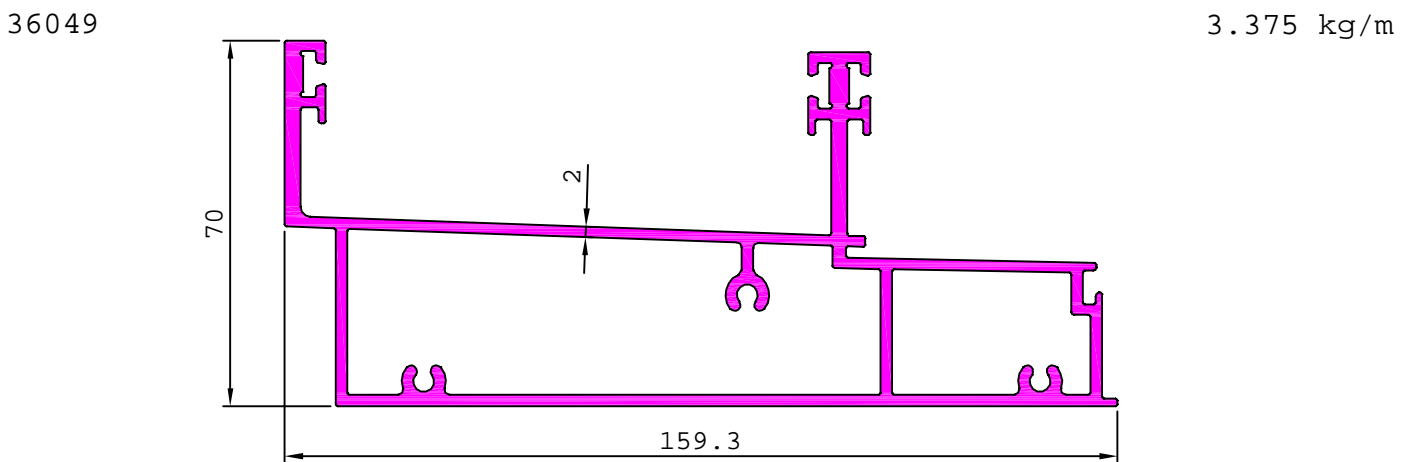
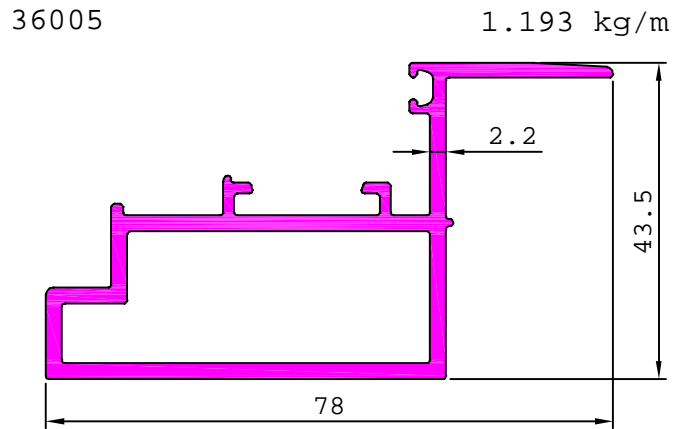
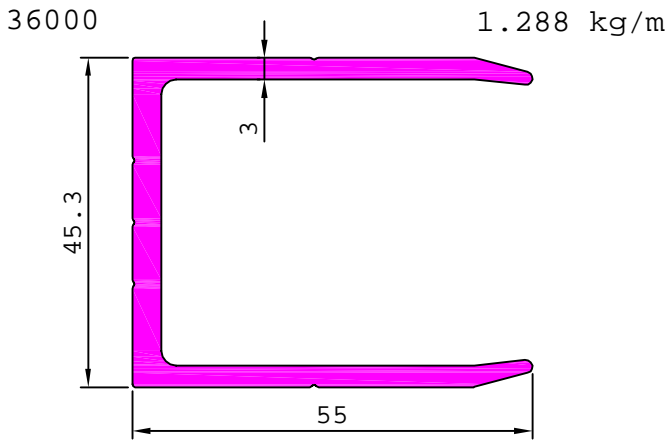

## CURTAIN WALL SECTION

36066

0.714 kg/m

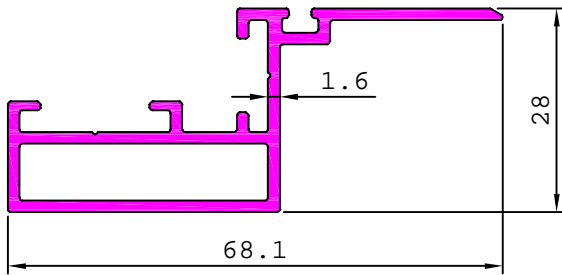

35987

0.703 kg/m

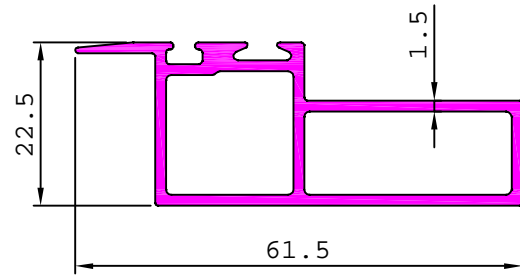

36059

0.171 kg/m

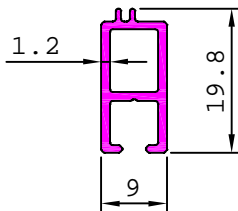

36031

0.279 kg/m

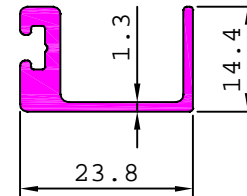

36039

0.346 kg/m

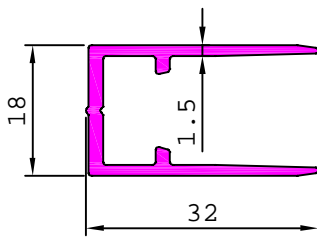

S5174

0.838 kg/m

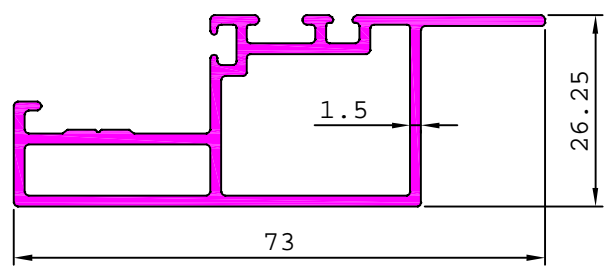

S5928

0.693 kg/m

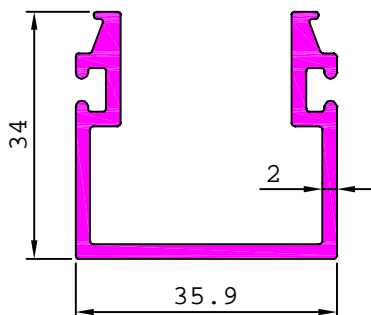

MATCHING WITH S5929

S5929

0.261 kg/m

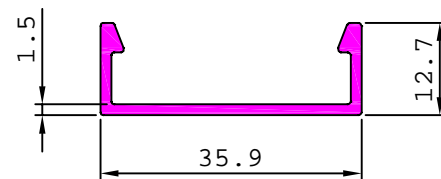

MATCHING WITH S5930

## CURTAIN WALL SECTION

36101 3.438 kg/m

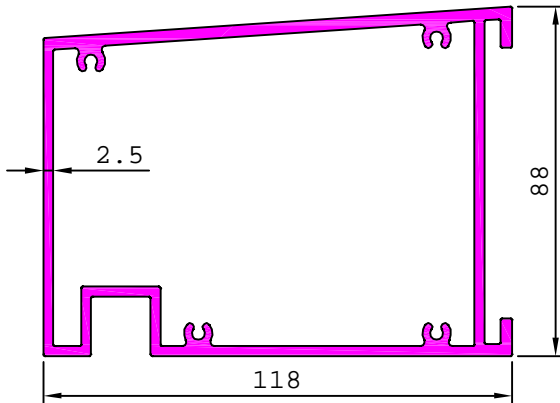

36030 0.339 kg/m

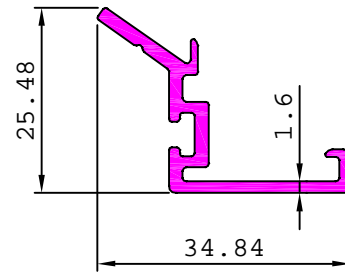

36125 0.563 kg/m

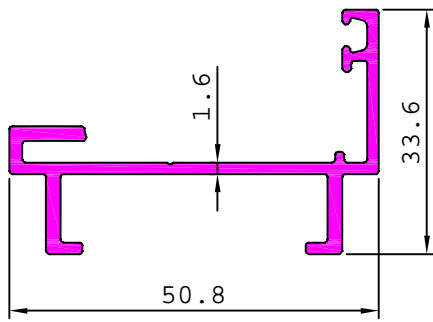

36120 0.770 kg/m

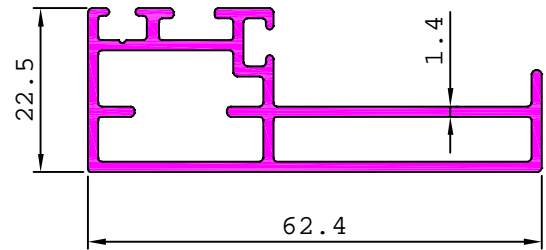

36181 1.103 kg/m

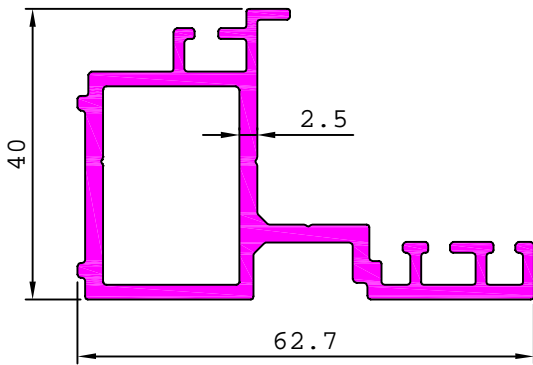

35966 0.492 kg/m

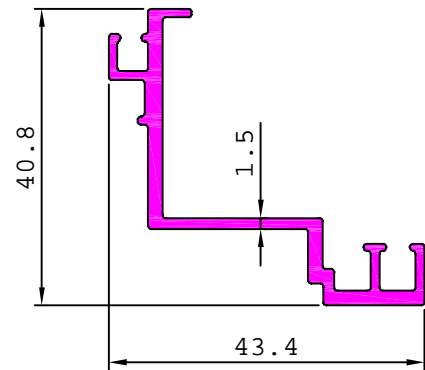

36180 1.368 kg/m

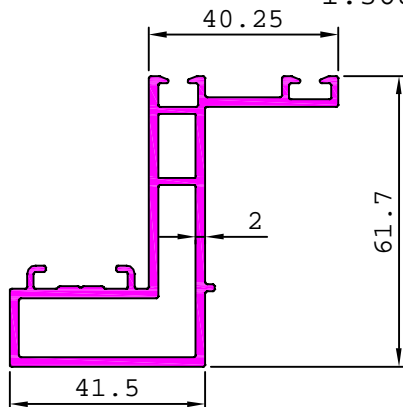

35967 0.770 kg/m

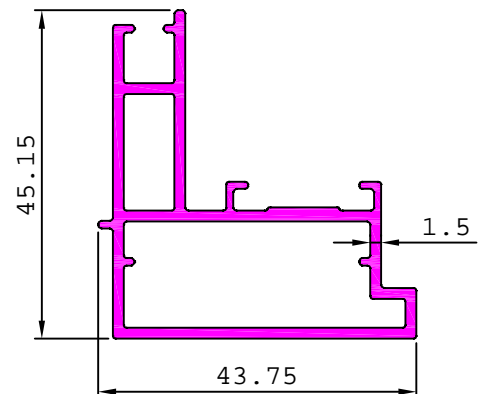

## CURTAIN WALL SECTION

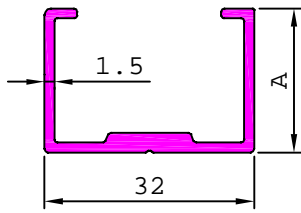

Sl No	Section No	A	Weight kg/m
1	<b>36275</b>	22.00	0.375
2	<b>36276</b>	20.00	0.359

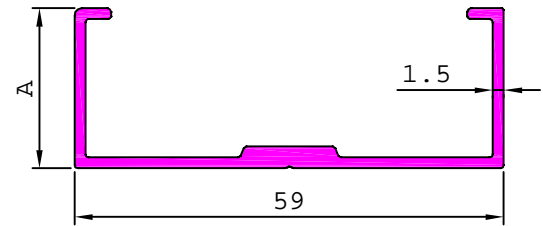

Sl No	Section No	A	Weight kg/m
1	<b>36277</b>	22.00	0.485
2	<b>36278</b>	20.00	0.469

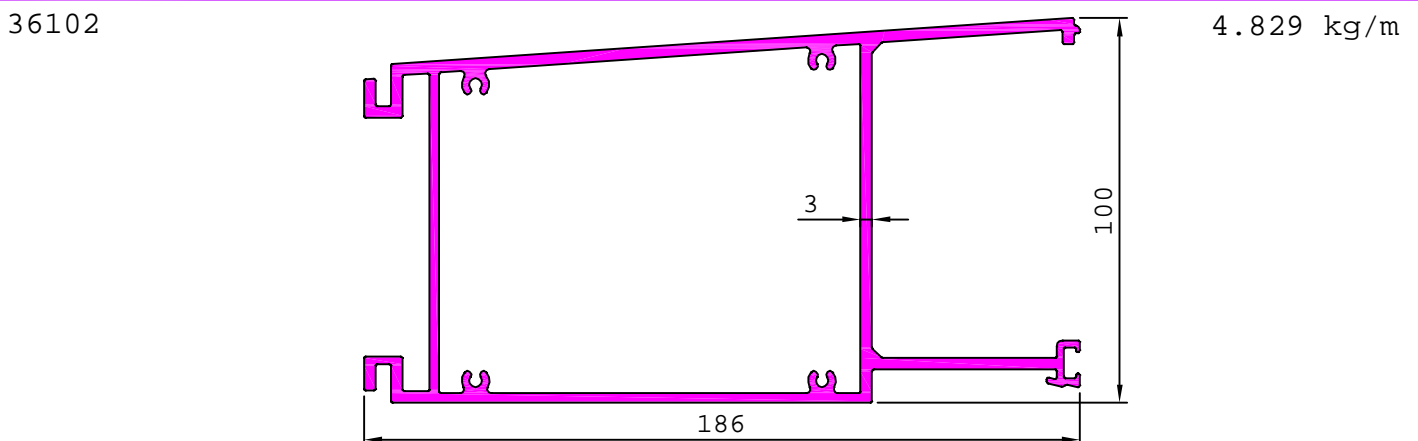
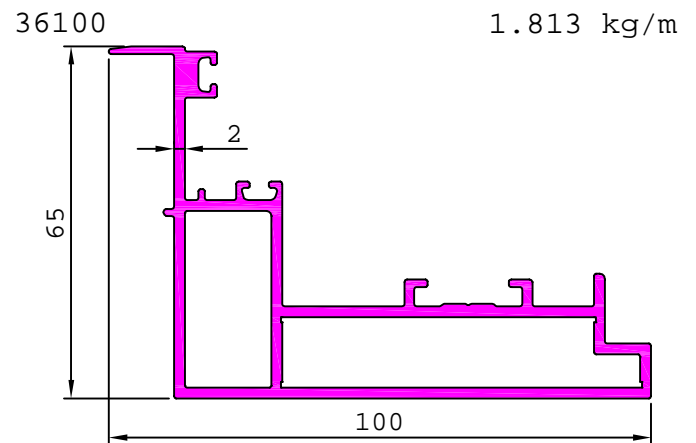
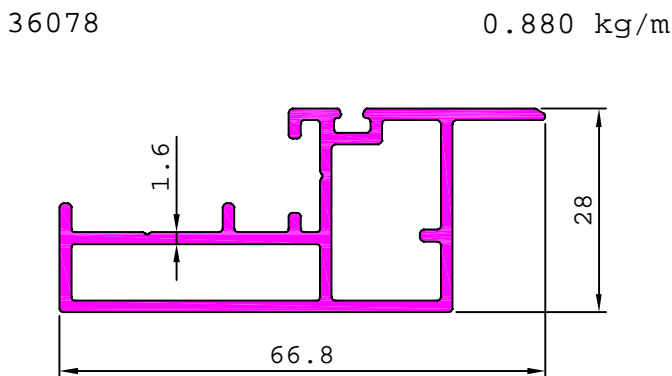
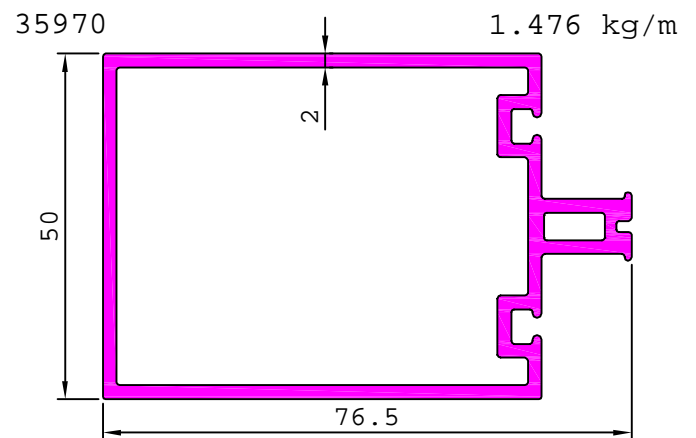
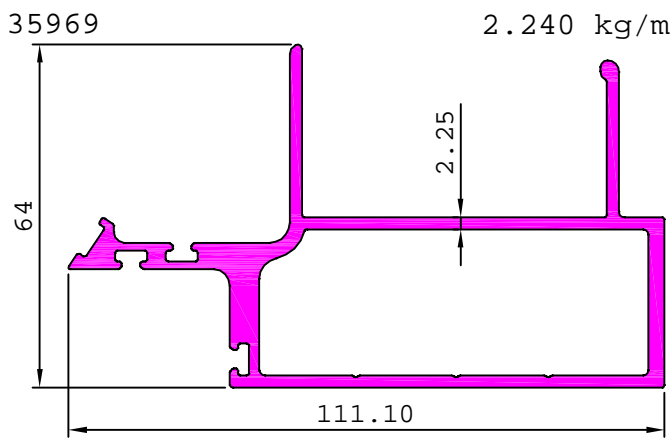

# CURTAIN WALL SECTION

S5375

1.859 kg/m

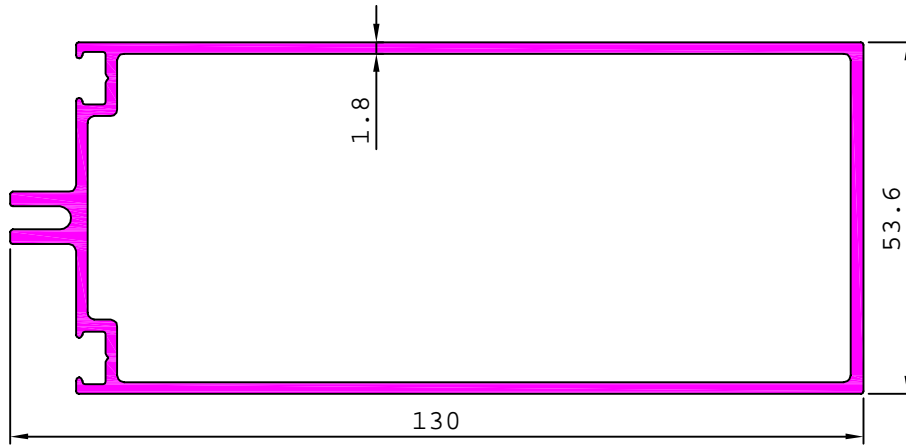

36124

1.380 kg/m

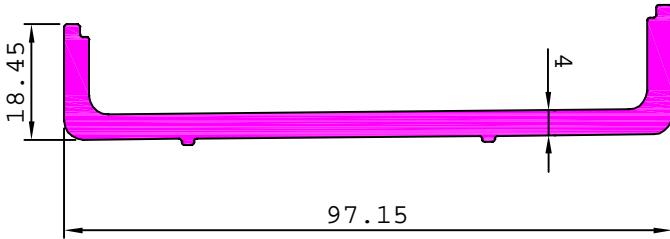

28444

0.370 kg/m

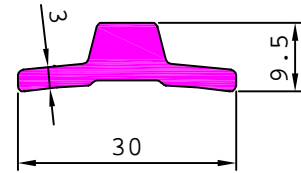

36142

6.560 kg/m

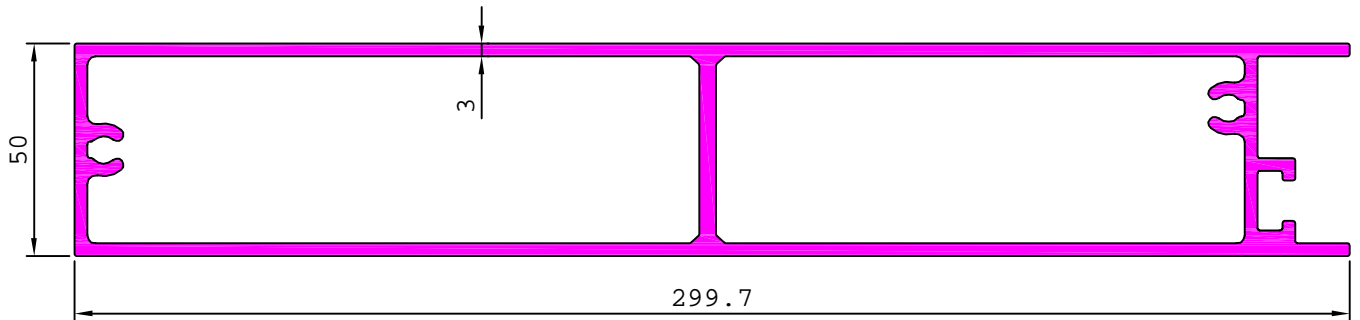

36221

0.950 kg/m

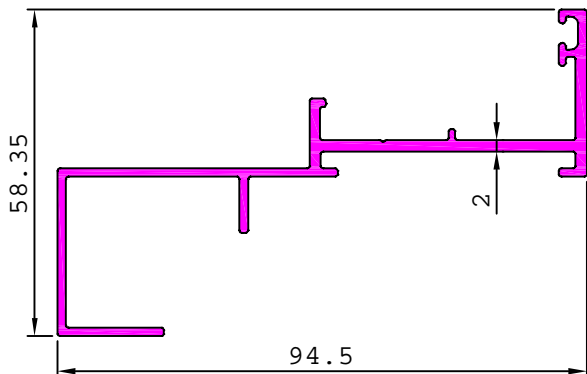

36220

0.565 kg/m

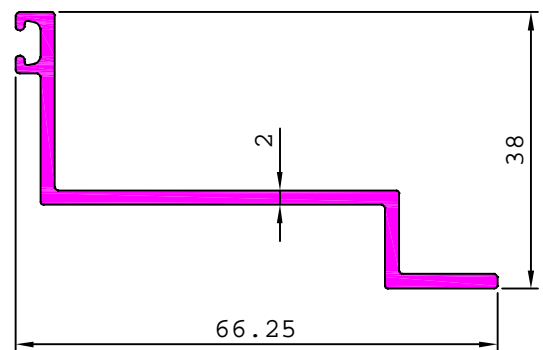

## CURTAIN WALL SECTION

S5869

0.601 kg/m

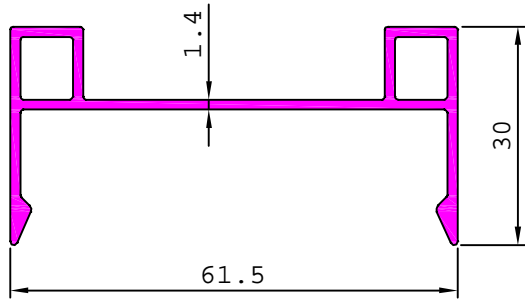

36222

1.231 kg/m

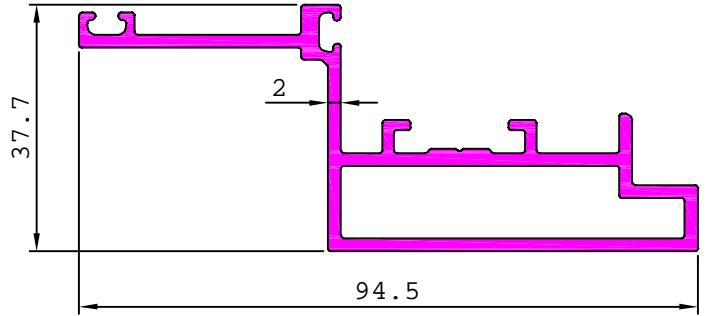

36219

8.546 kg/m

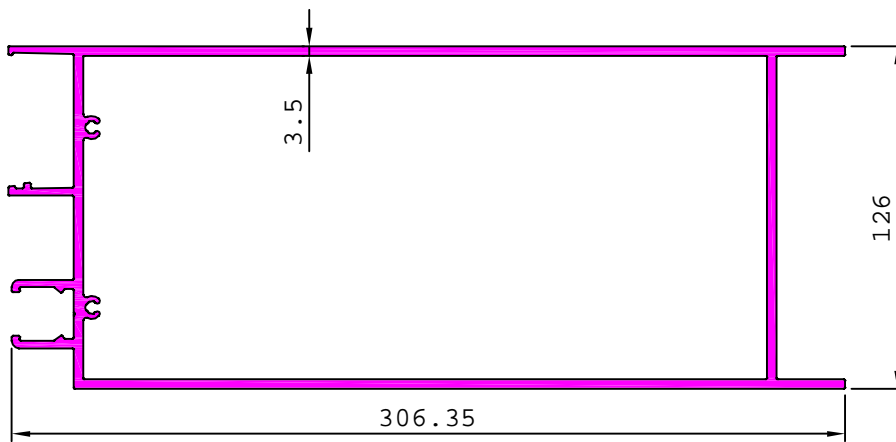

36168

2.828 kg/m

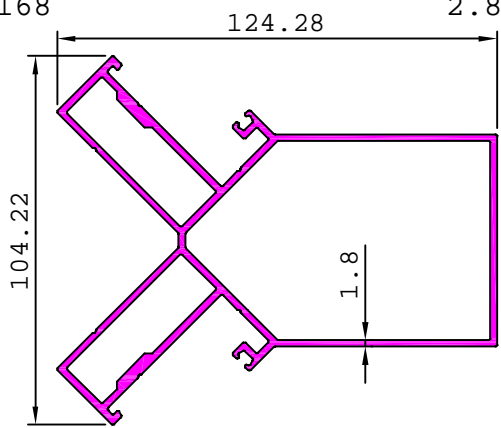

S6101

0.539 kg/m

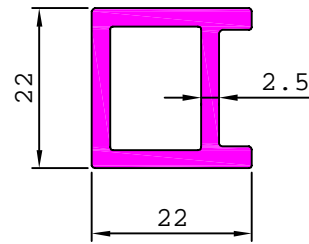

36141

0.465 kg/m

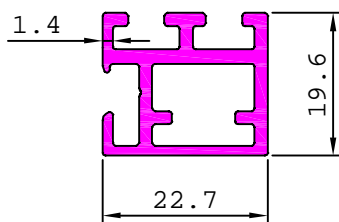

S5517

5.152 kg/m

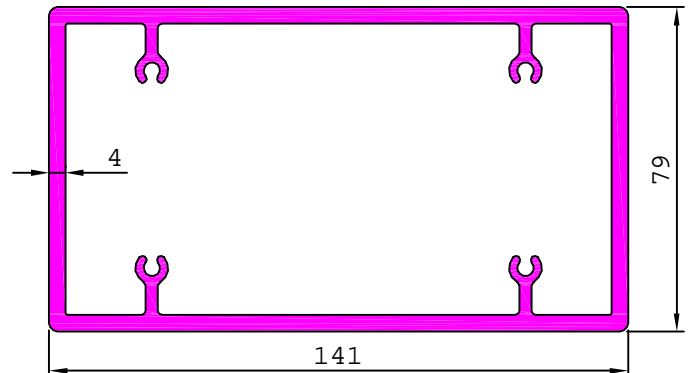

MATCHING WITH 36140

MATCHING WITH 35579

## CURTAIN WALL SECTION

S5969

2.267 kg/m

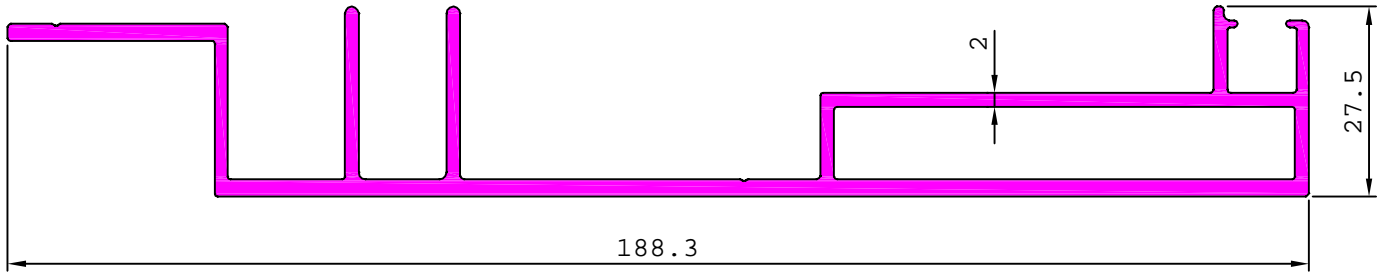

36262

0.475 kg/m

36263

1.012 kg/m

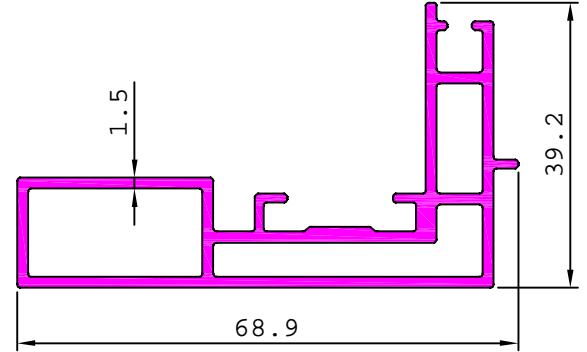
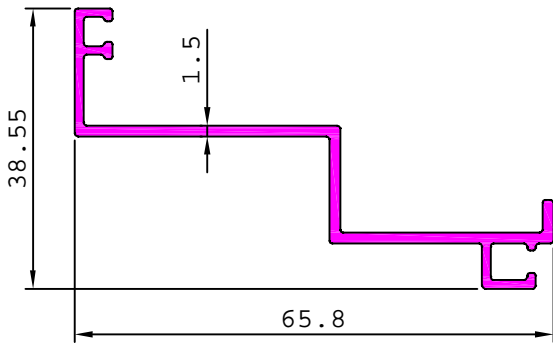

S5906

3.276 kg/m

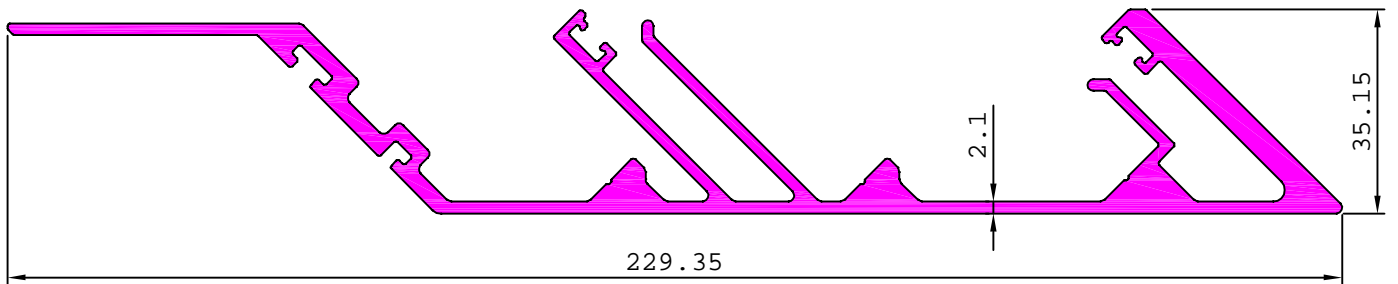

S6067

0.662 kg/m

S6078

0.698 kg/m

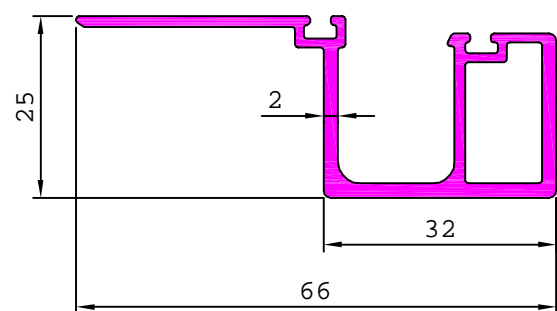
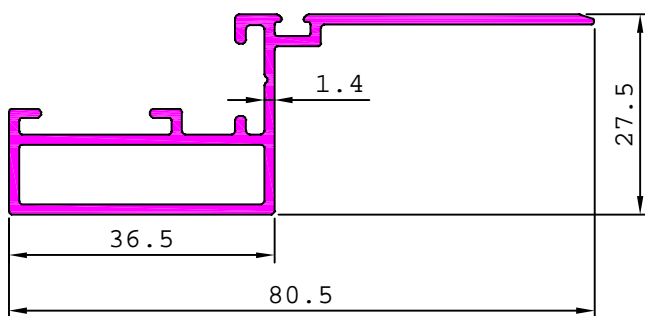

## CURTAIN WALL SECTION

36118

0.446 kg/m

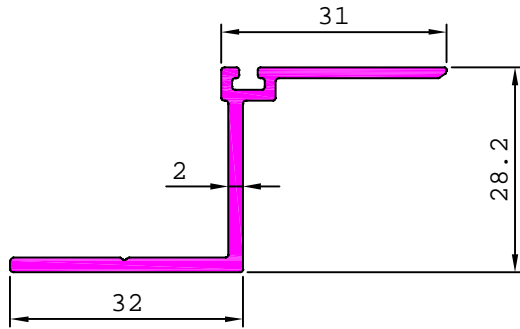

36119

1.690kg/m

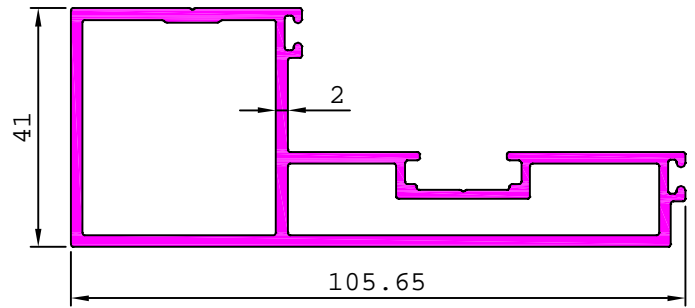

36081

0.494 kg/m

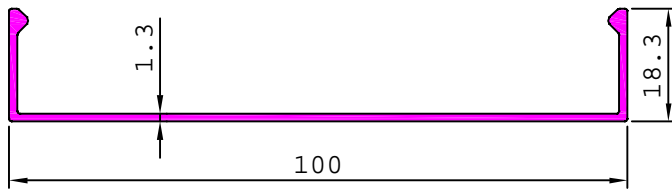

36082

0.674 kg/m

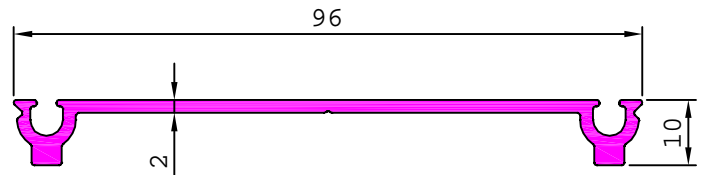

S5840

0.423 kg/m

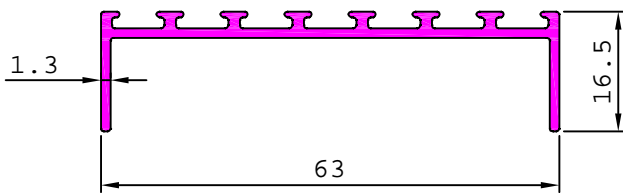

S6273

2.091 kg/m

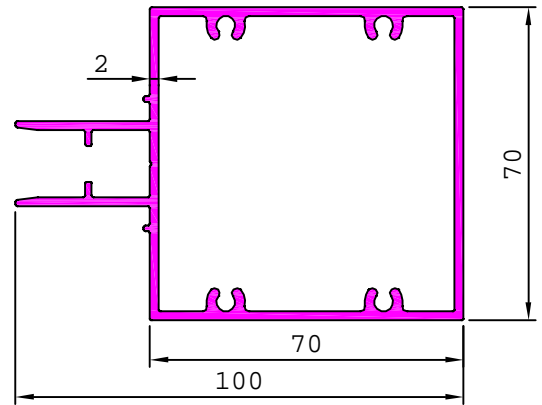

S6272

0.321 kg/m

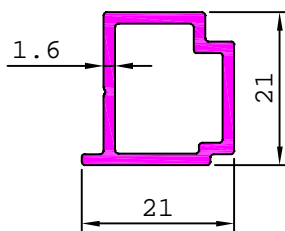

## CURTAIN WALL SECTION

36284

1.153 kg/m

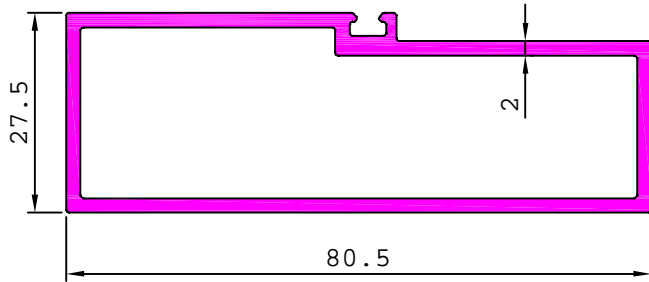

35980

0.763 kg/m

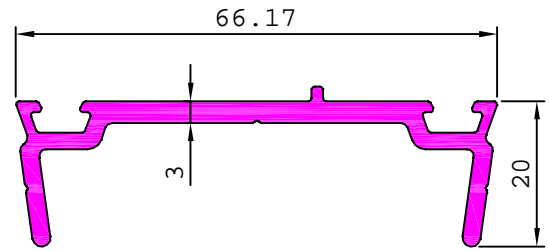

**MATCHING WITH 35867**

36286

4.139 kg/m

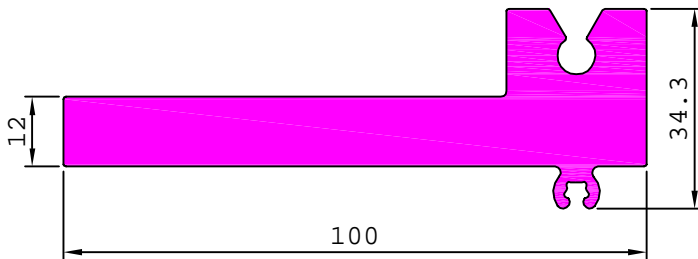

S6146

1.054 kg/m

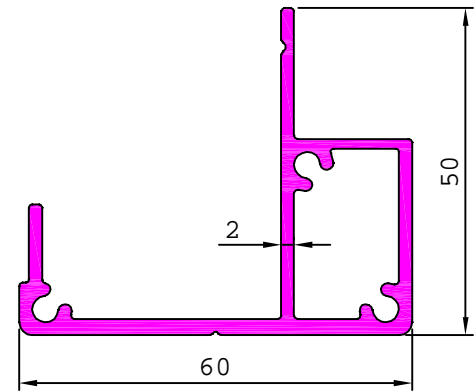

S6219

0.826 kg/m

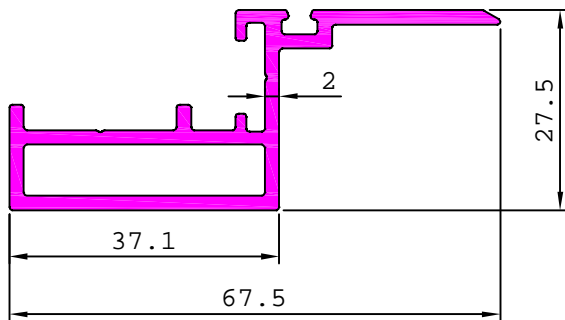

**MATCHING WITH 29073**

S6220

0.428 kg/m

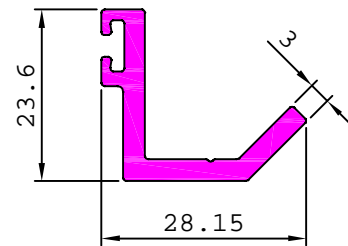

S6221

0.338 kg/m

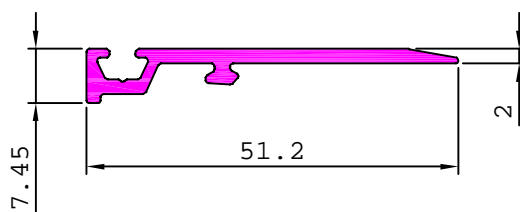

36122

1.077 kg/m

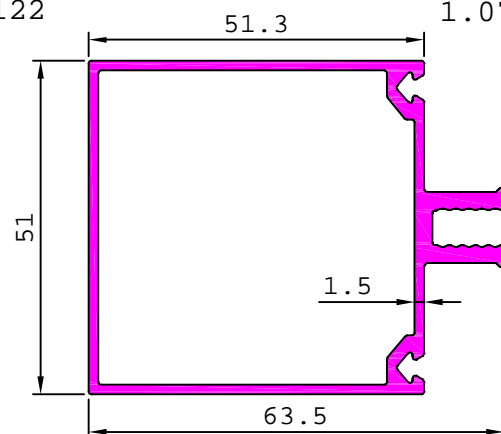

# CURTAIN WALL SECTION

36159

3.886 kg/m

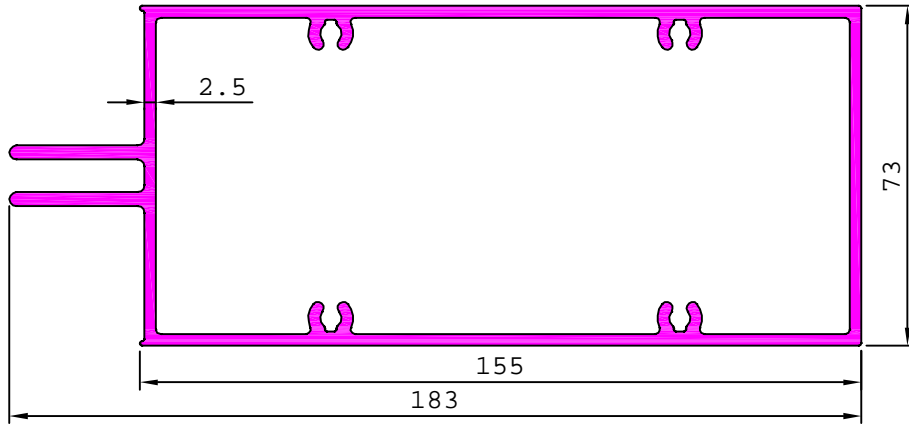

35977

5.545 kg/m

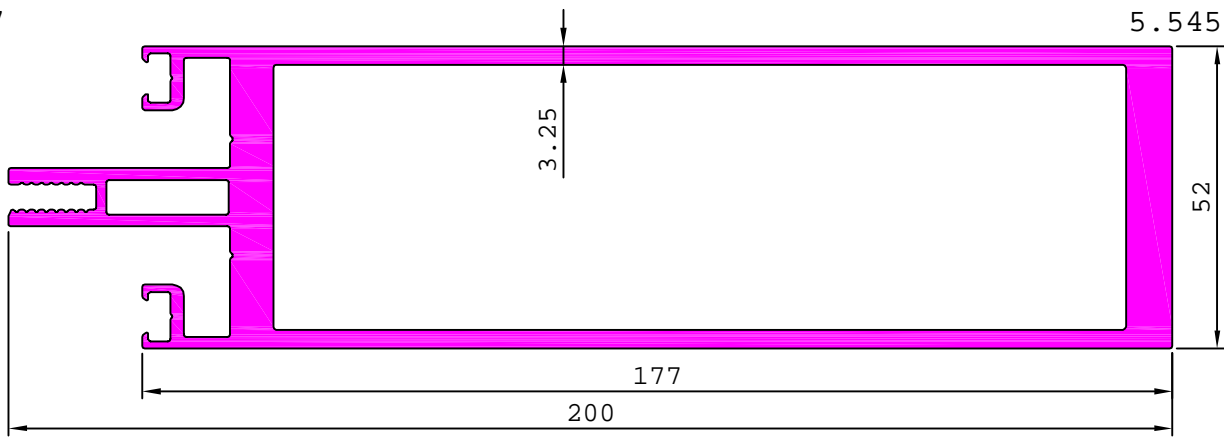

S6314

8.208 kg/m

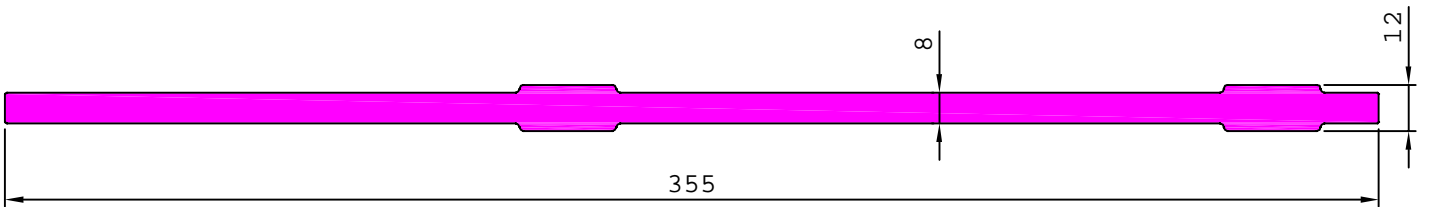

S6325

4.639 kg/m

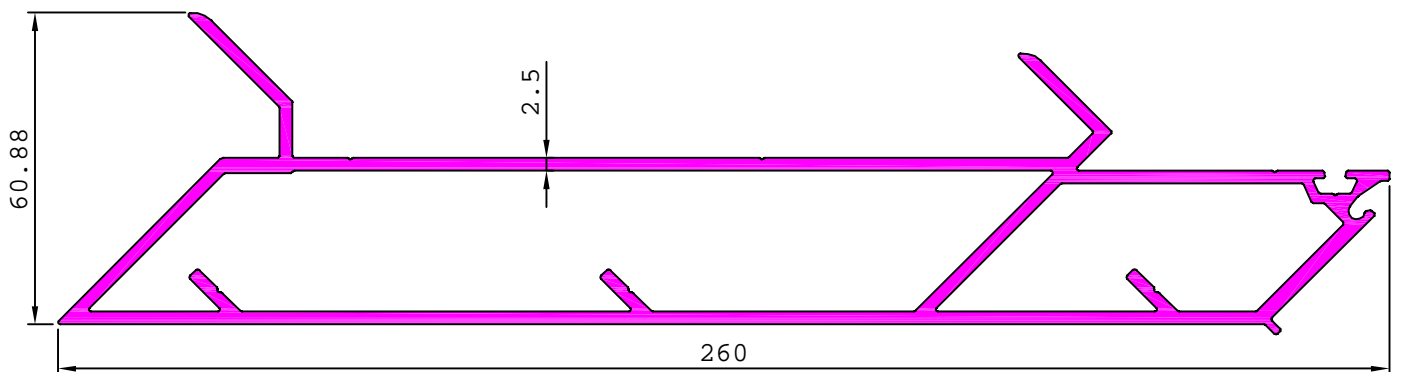

# CURTAIN WALL SECTION

S6326

4.259 kg/m

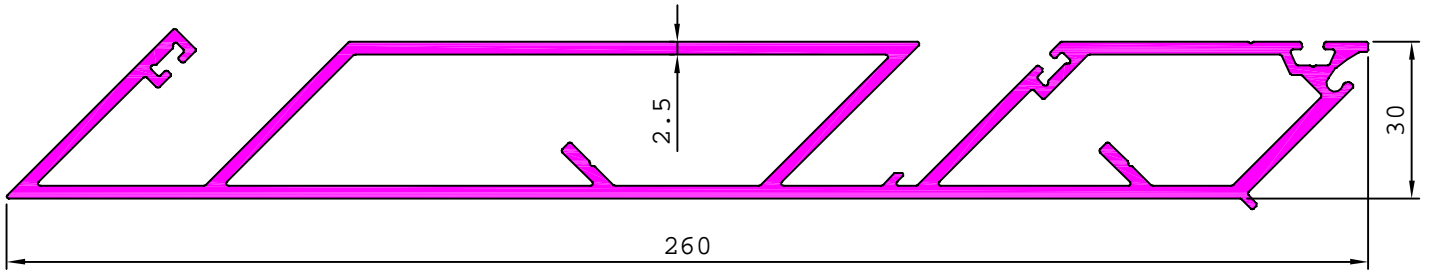

36132

3.016 kg/m

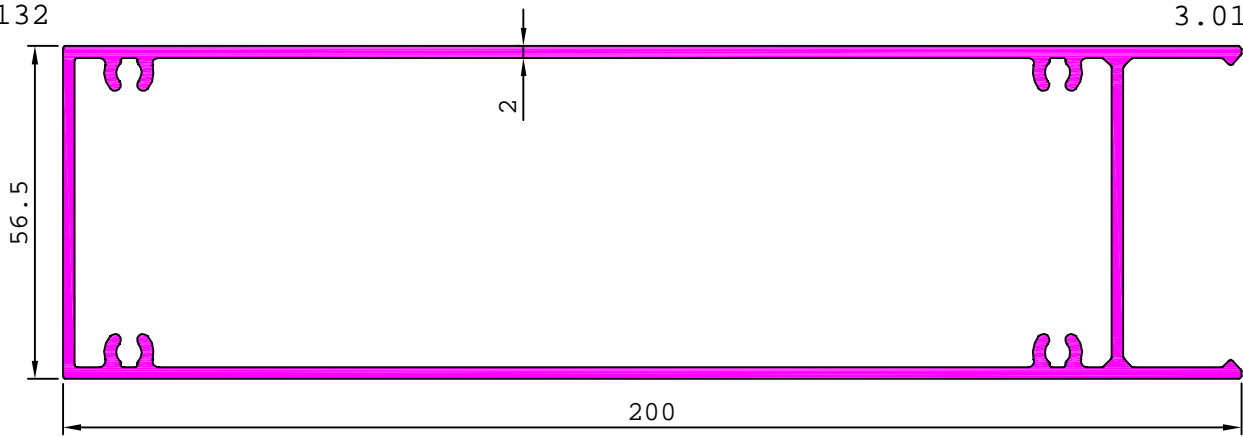

## CURTAIN WALL SECTION

S6327

0.230 kg/m

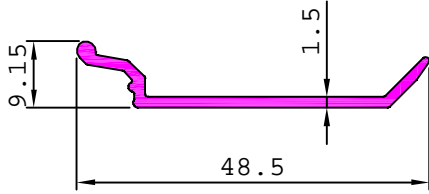

S6477

0.796 kg/m

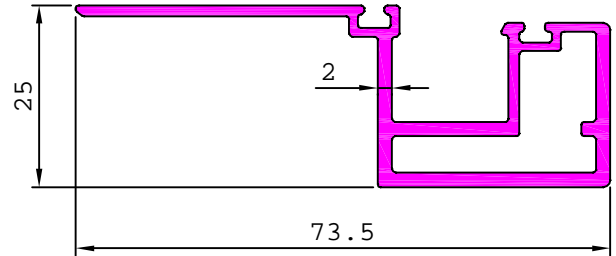

36150

0.911 kg/m

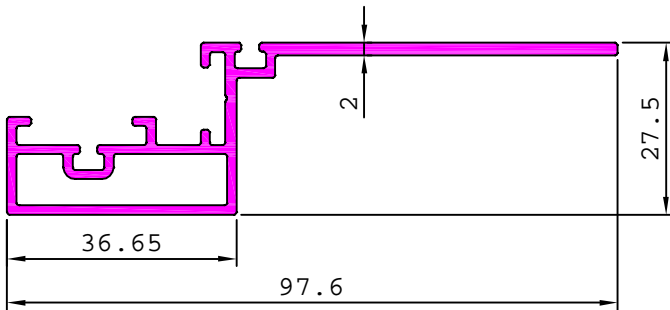

36151

1.143 kg/m

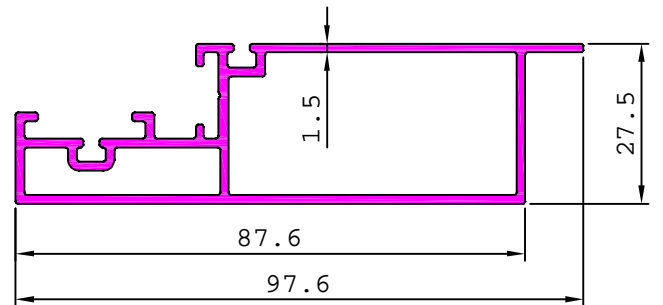

36135

0.470 kg/m

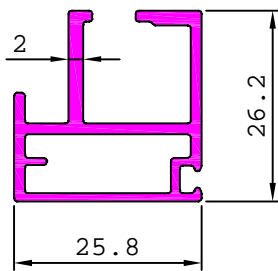

36154

0.854 kg/m

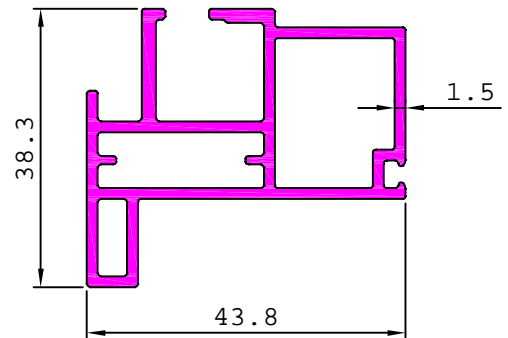

36155

1.659 kg/m

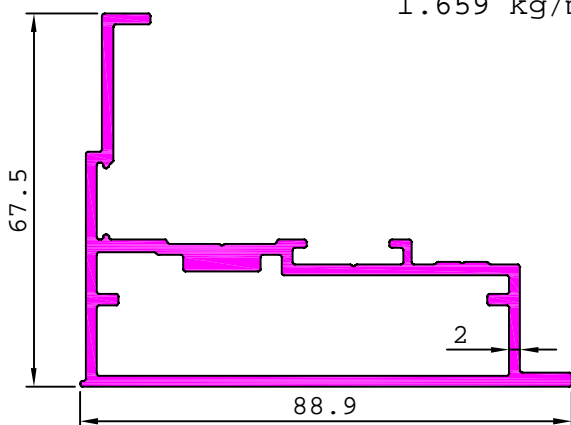

36156

1.038 kg/m

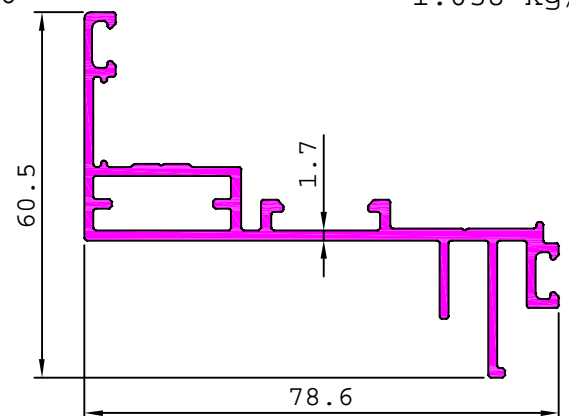

## CURTAIN WALL SECTION

S6496

1.307 kg/m

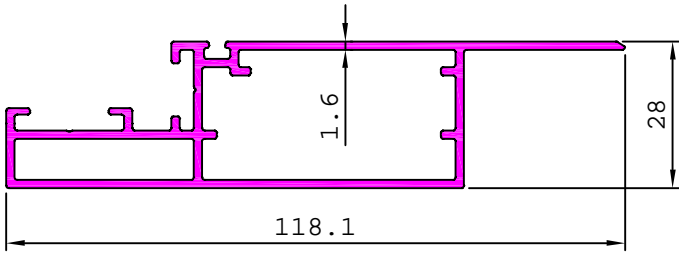

**MATCHING WITH 29073**

S6564

0.873 kg/m

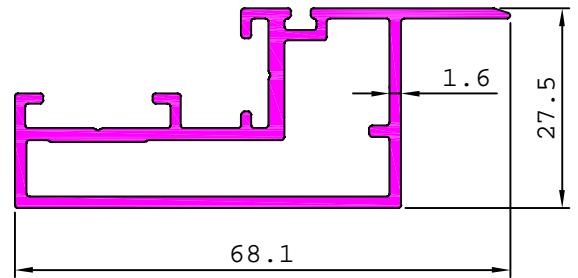

S6497

0.595 kg/m

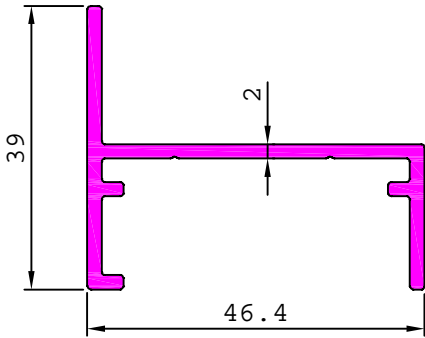

S6600

1.239 kg/m

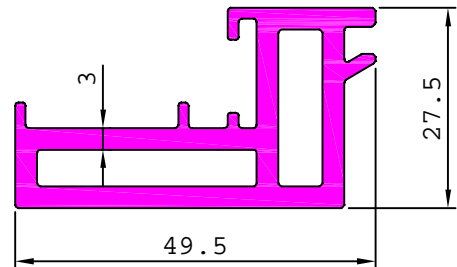

S6521

1.782 kg/m

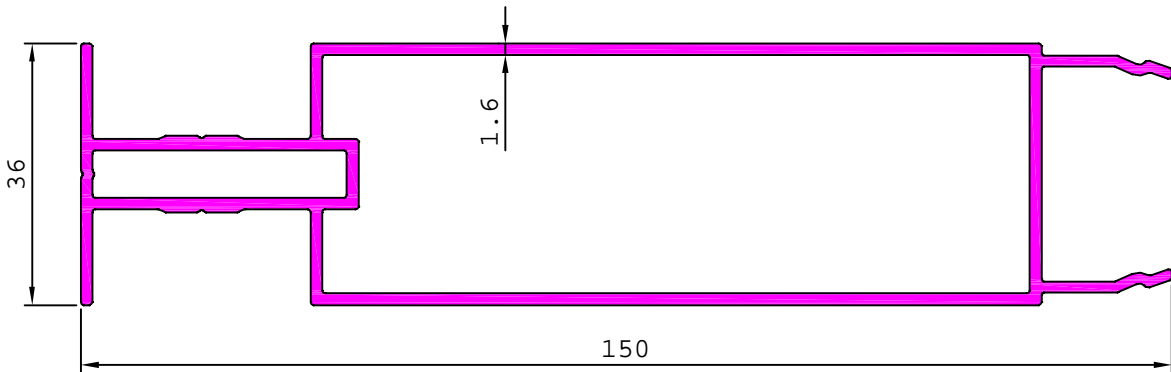

**MATCHING WITH S6522**

S6522

1.596 kg/m

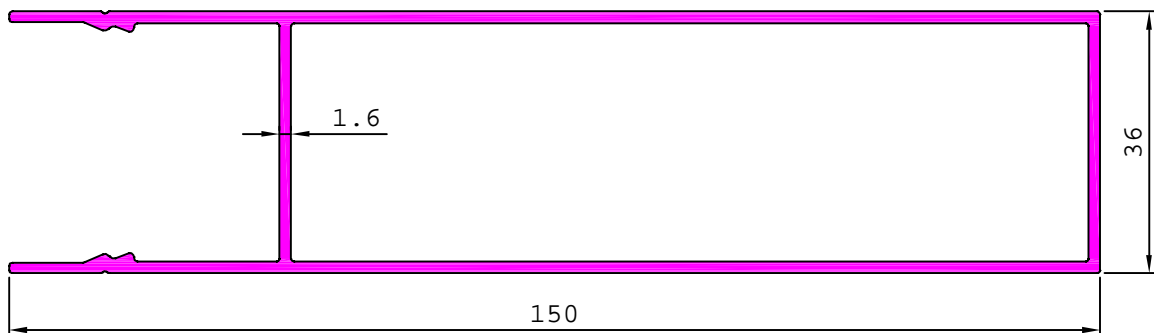

**MATCHING WITH S6521**

## CURTAIN WALL SECTION

S6574

0.429 kg/m

36163

0.625 kg/m

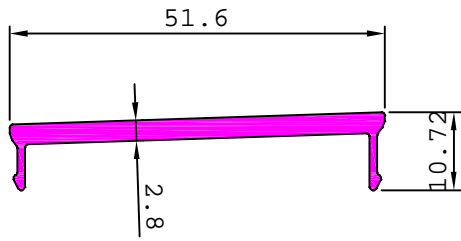

MATCHING WITH S6573

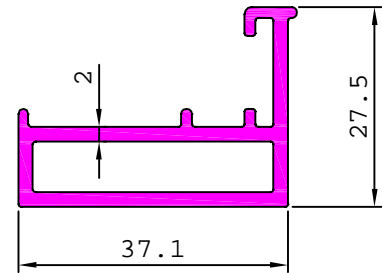

S6573

7.325 kg/m

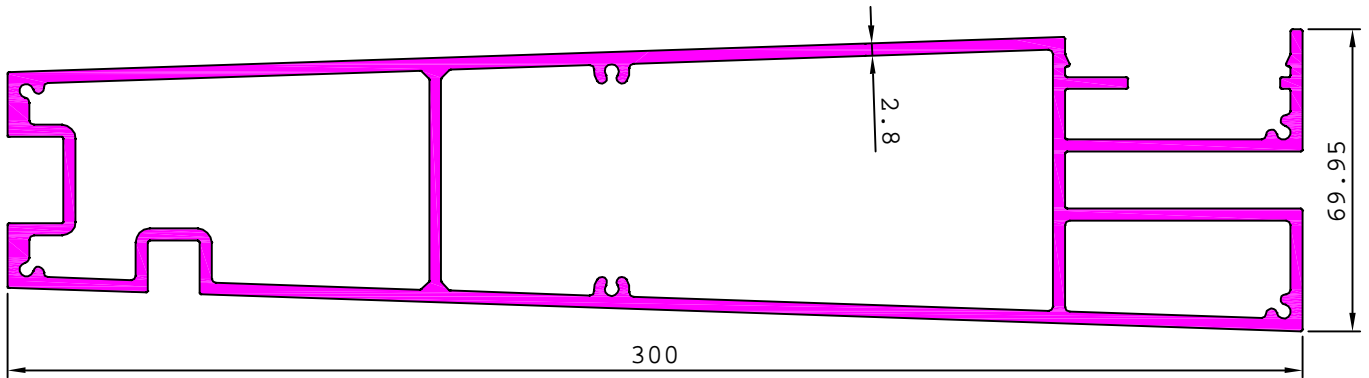

MATCHING WITH S6574

S6698

0.698 kg/m

S6733

0.515 kg/m

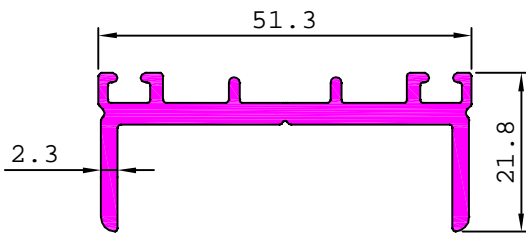

MATCHING WITH G102460

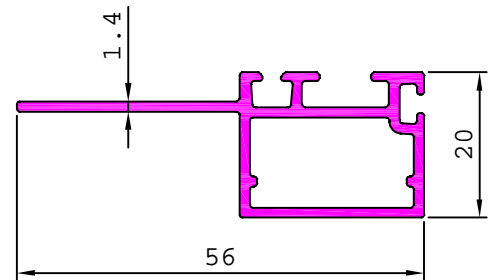

MATCHING WITH 35784

S6473

0.467 kg/m

S6508

1.006 kg/m

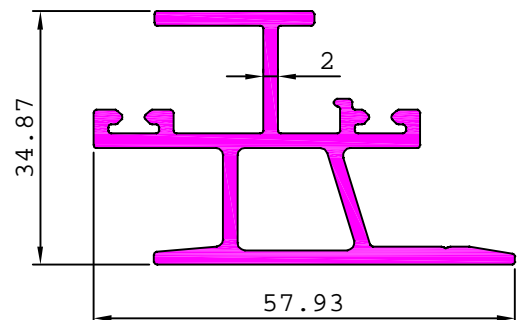
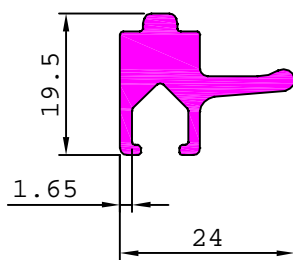

## CURTAIN WALL SECTION

S6474

0.694 kg/m

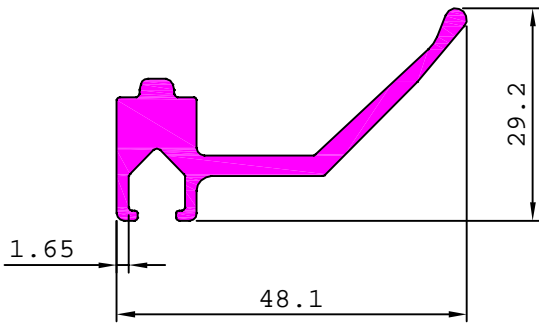

S6475

0.253 kg/m

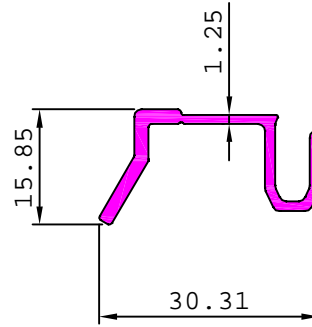

S6509

0.761 kg/m

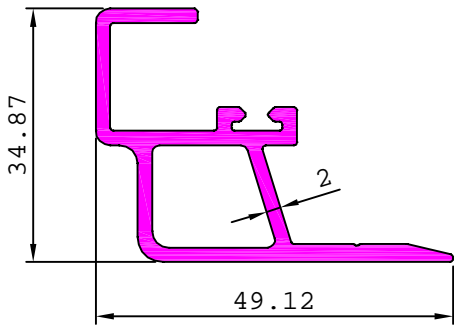

S6510

0.725 kg/m

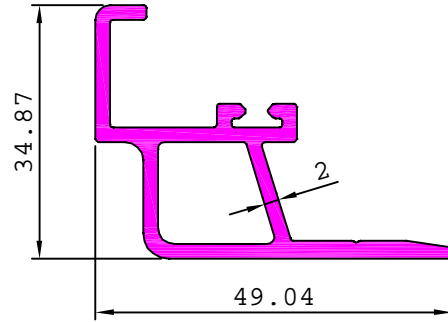

S6568

3.653 kg/m

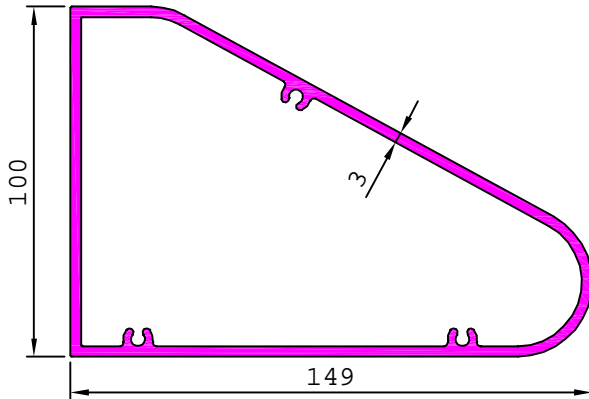

S6572

0.717 kg/m

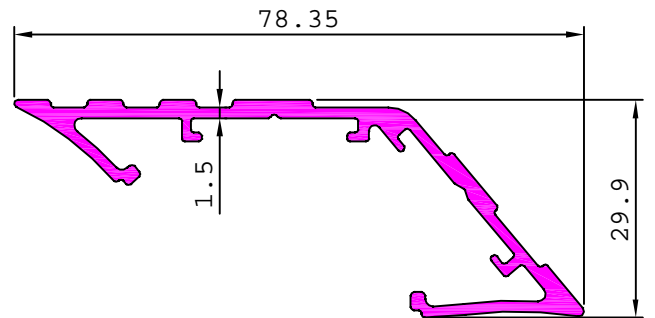

S6658

5.716 kg/m

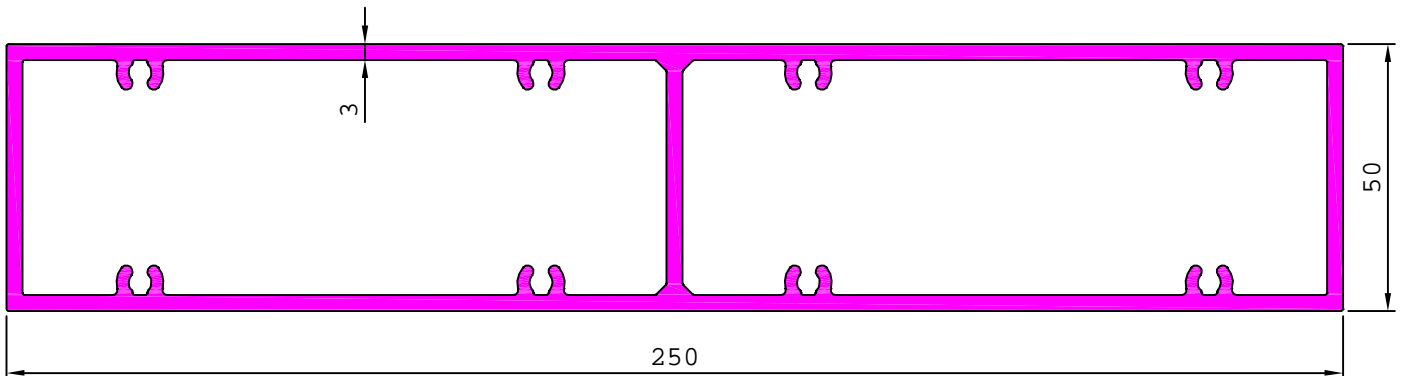

## CURTAIN WALL SECTION

S6695

1.601 kg/m

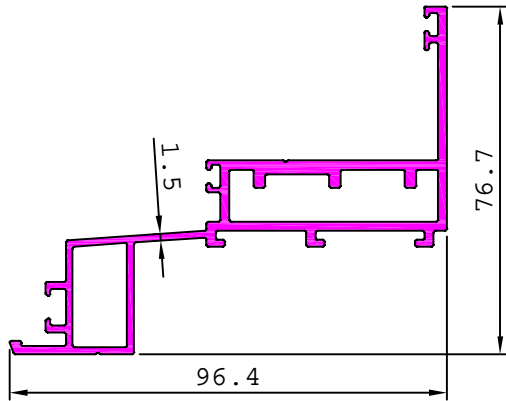

S6770

0.751 kg/m

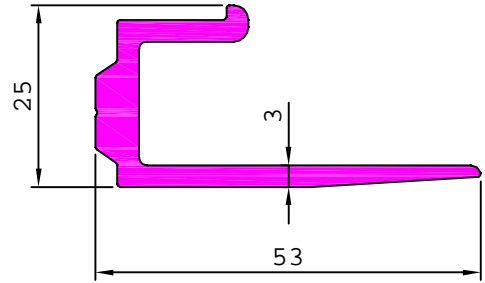

36184

0.390 kg/m

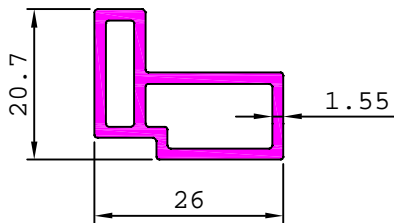

S6811

1.690 kg/m

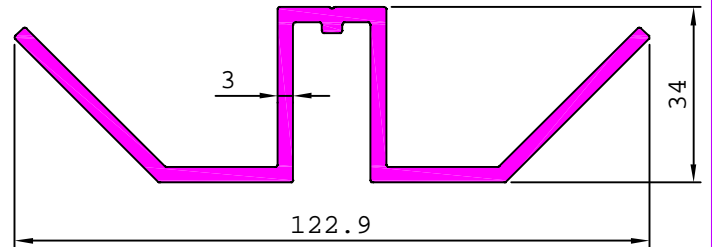

S6748

3.110 kg/m

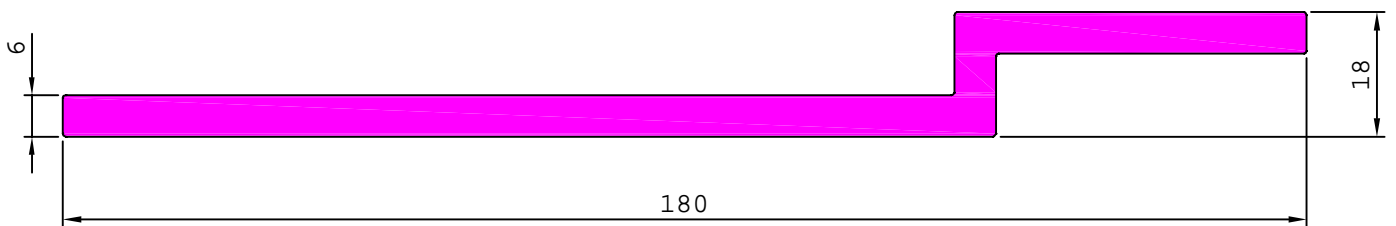

36157

1.580 kg/m

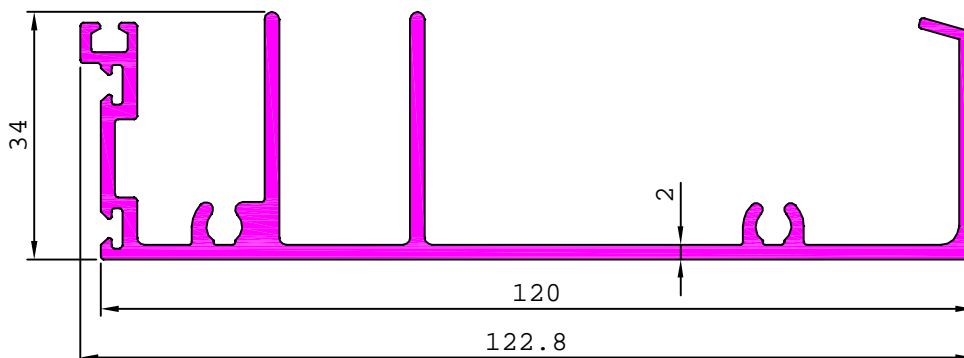

## CURTAIN WALL SECTION

S6783

6.598 kg/m

S6784

3.368 kg/m

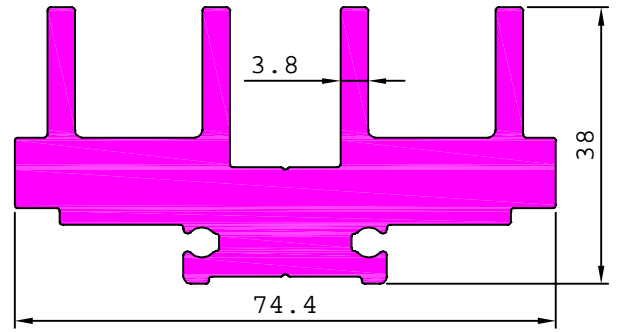
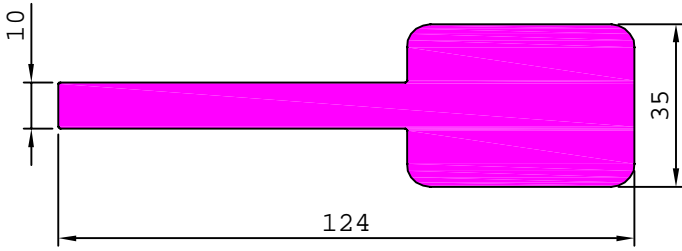

S6696

2.896 kg/m

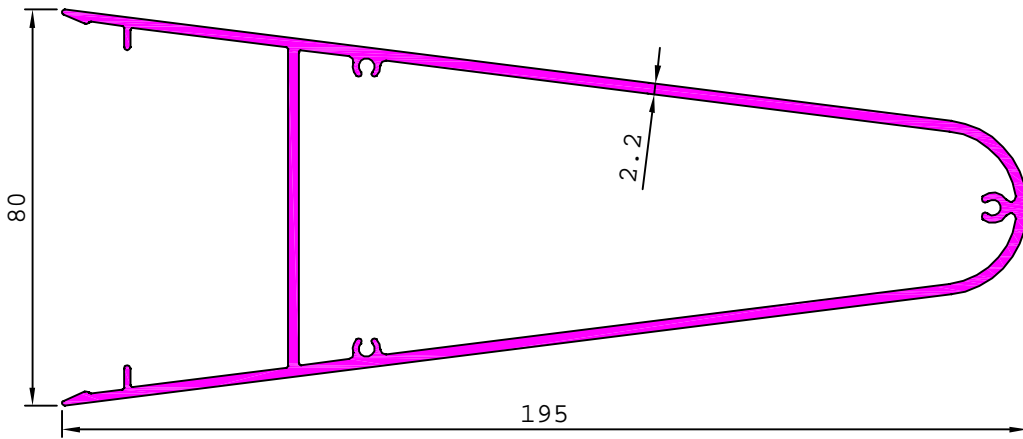

S6785

7.151 kg/m

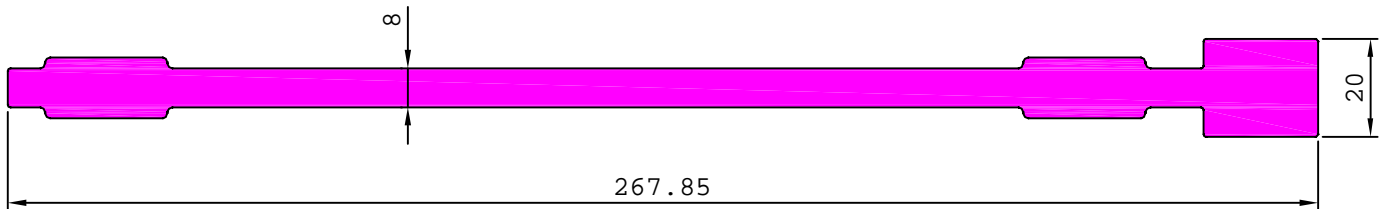

S6786

8.491 kg/m

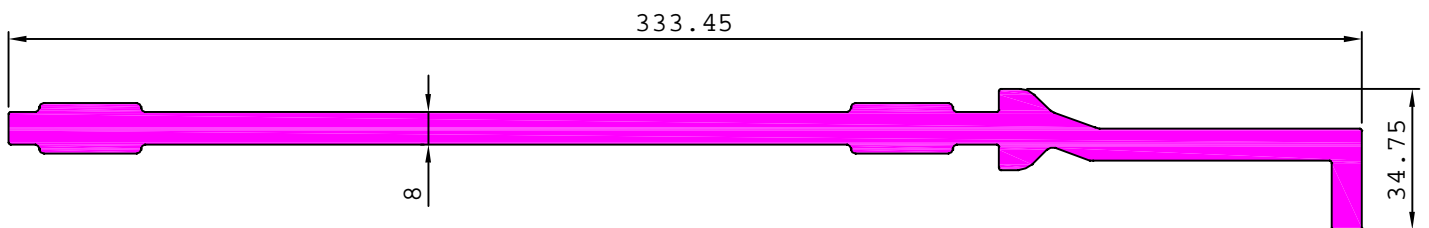

## CURTAIN WALL SECTION

36185

0.608 kg/m

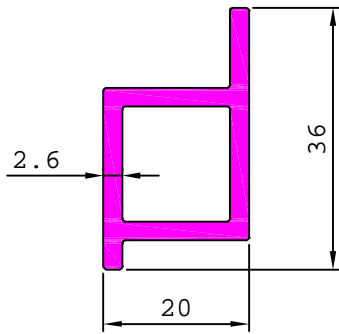

36224

0.757 kg/m

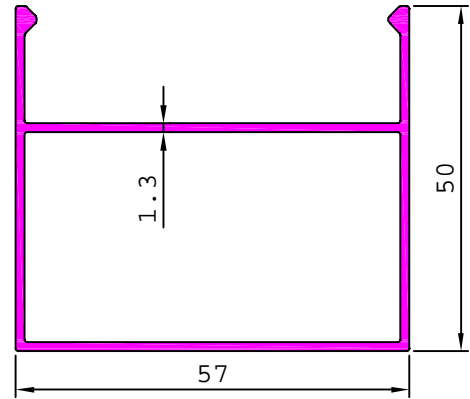

36235

2.925 kg/m

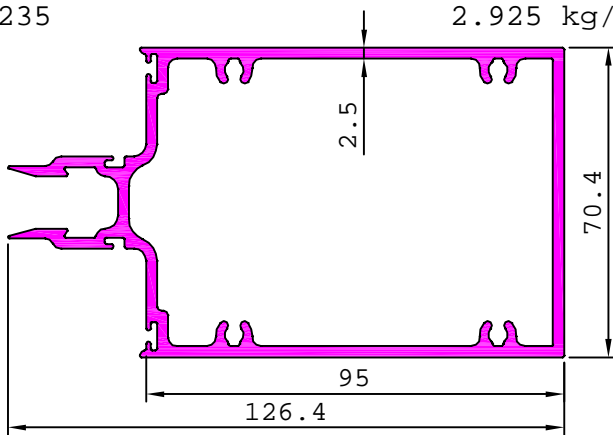

36216

0.785 kg/m

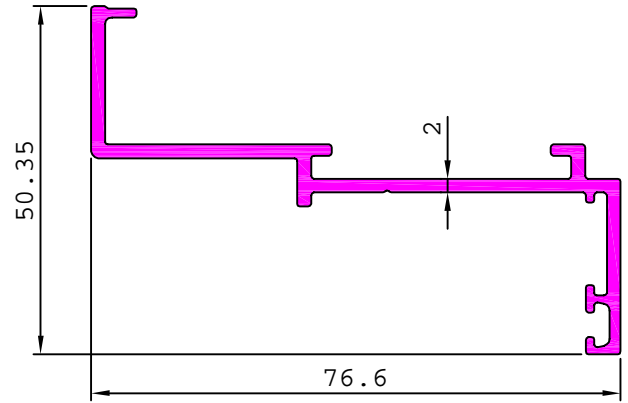

36234

3.460 kg/m

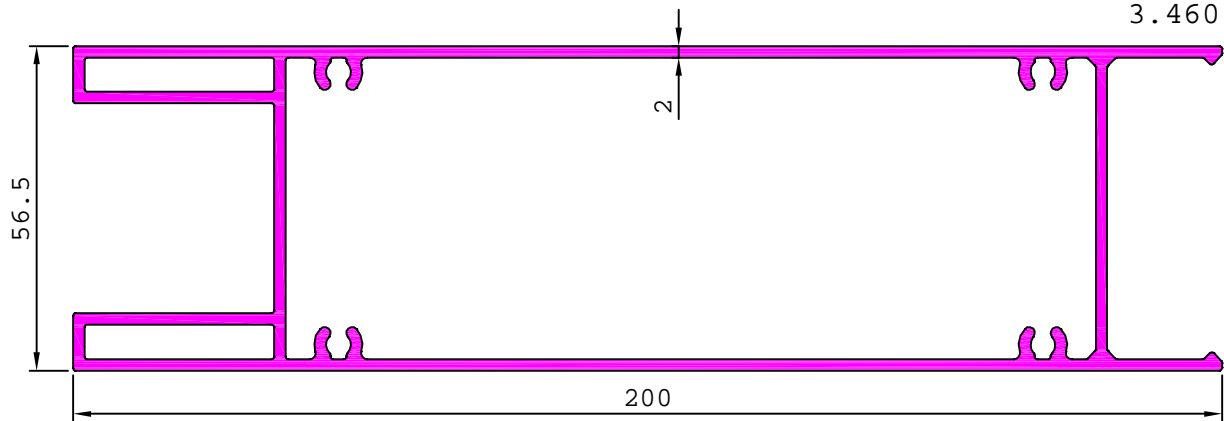

36236

1.107 kg/m

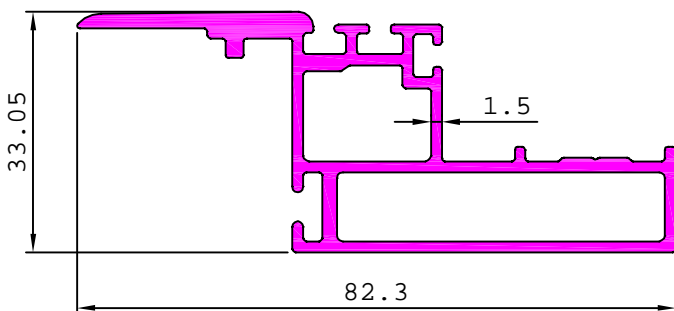

36237

1.262 kg/m

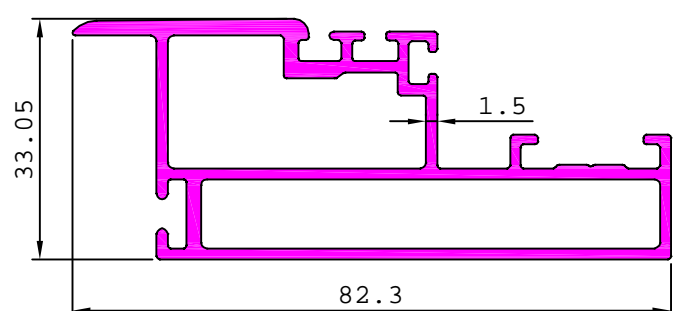

## CURTAIN WALL SECTION

36238

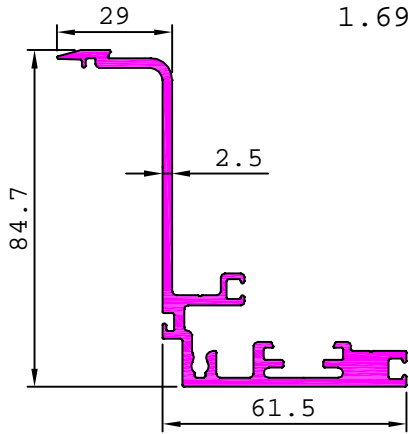

1.692 kg/m

36249

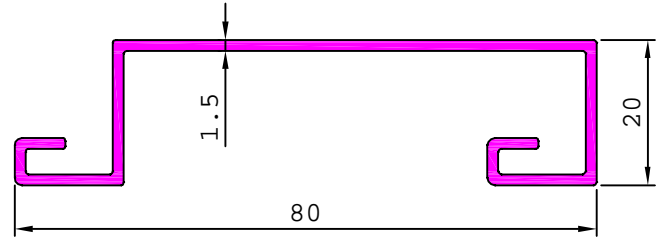

0.611 kg/m

36239

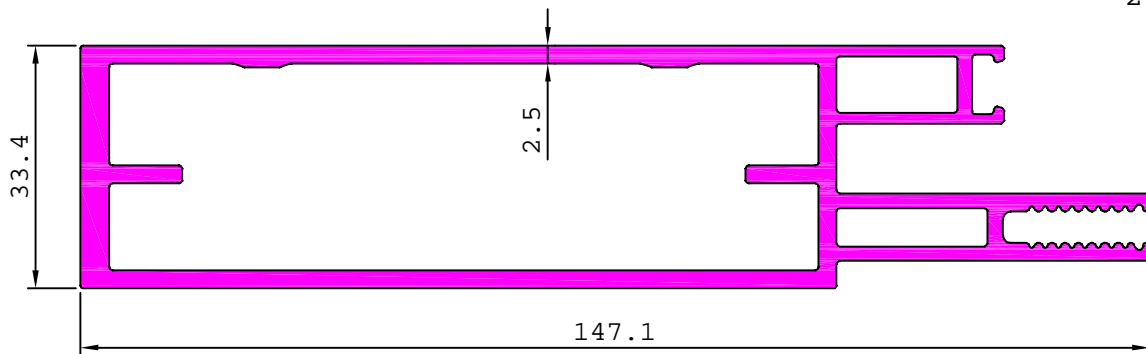

2.810 kg/m

36383

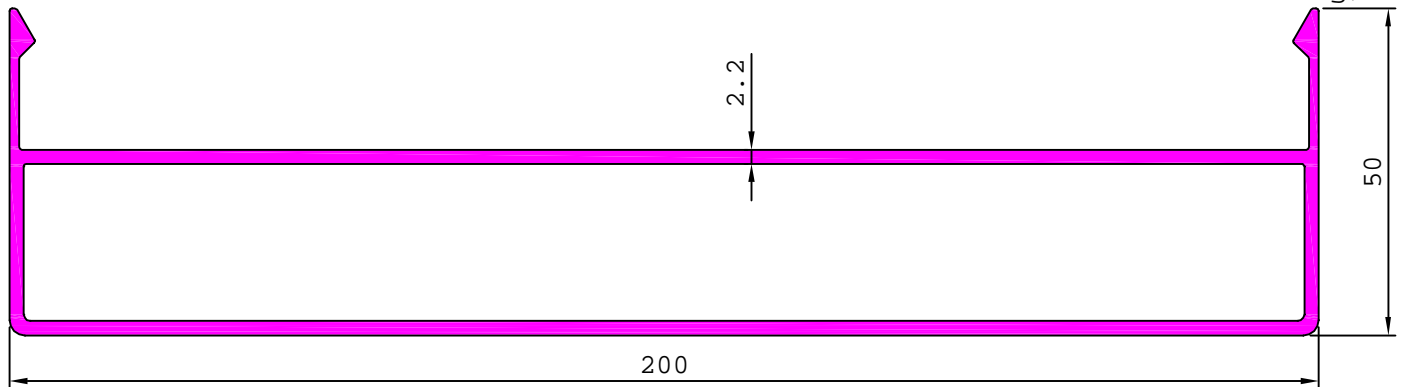

2.876 kg/m

MATCHING WITH 36384

36384

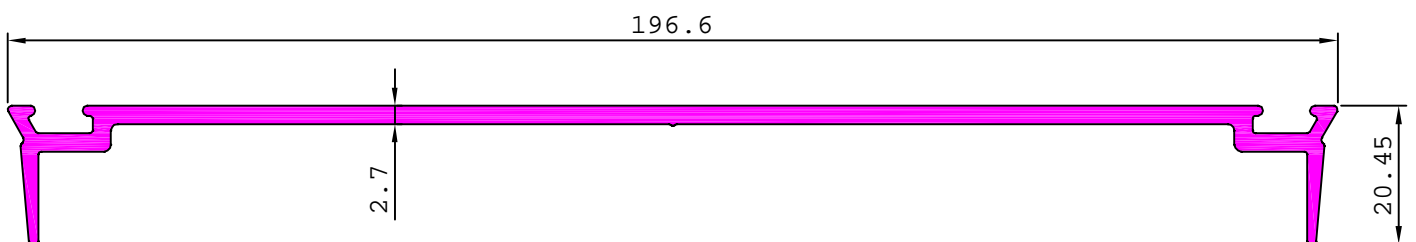

1.678 kg/m

## CURTAIN WALL SECTION

36247

1.380 kg/m

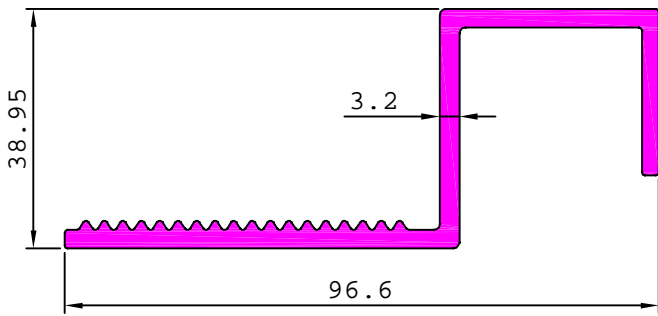

36248

1.731 kg/m

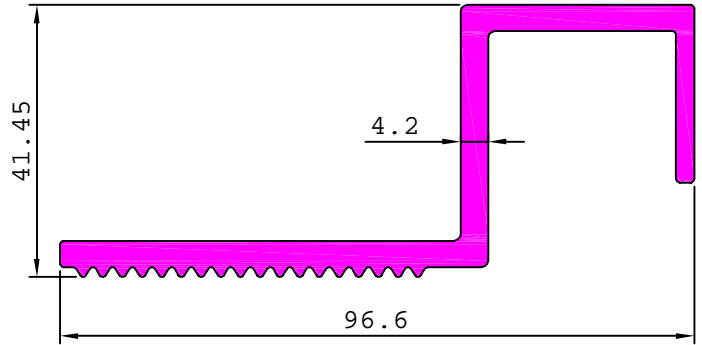

36161

1.416 kg/m

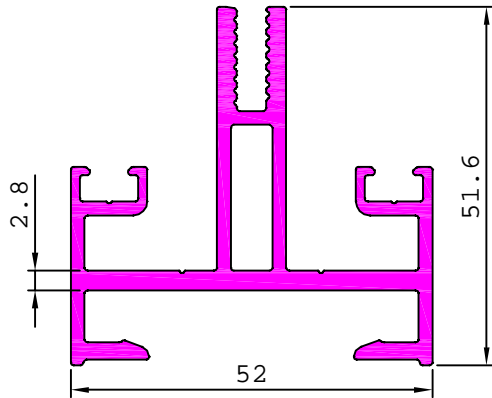

36251

1.021 kg/m

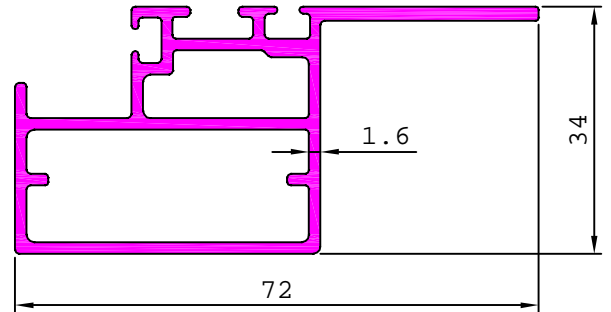

MATCHING WITH S6817

36252

0.556 kg/m

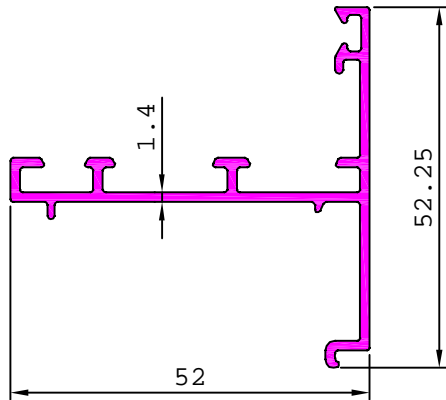

36253

0.425 kg/m

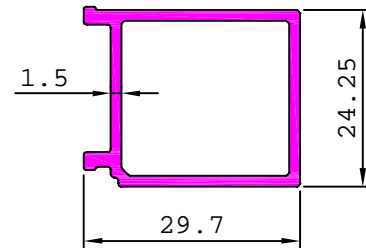

36264

0.942 kg/m

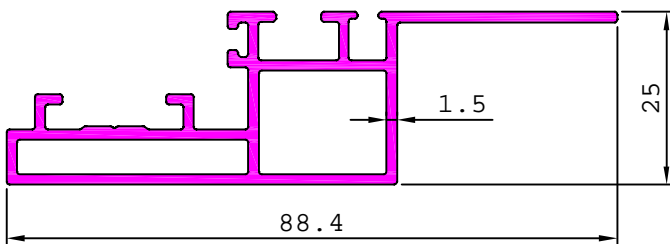

36265

0.927 kg/m

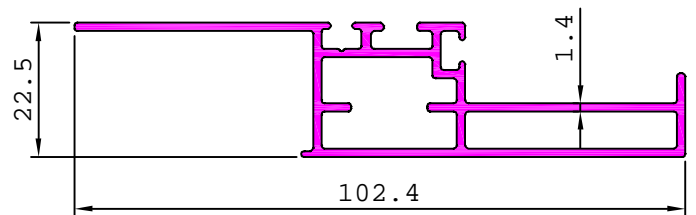

## CURTAIN WALL SECTION

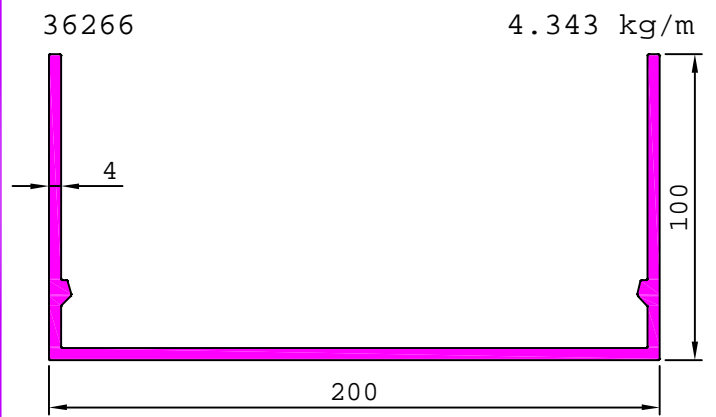
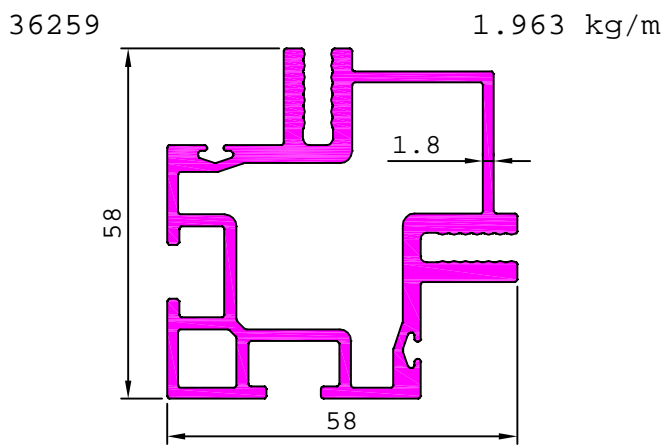
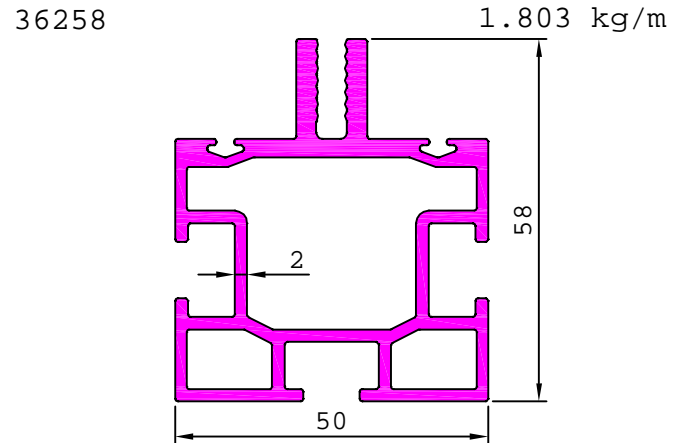
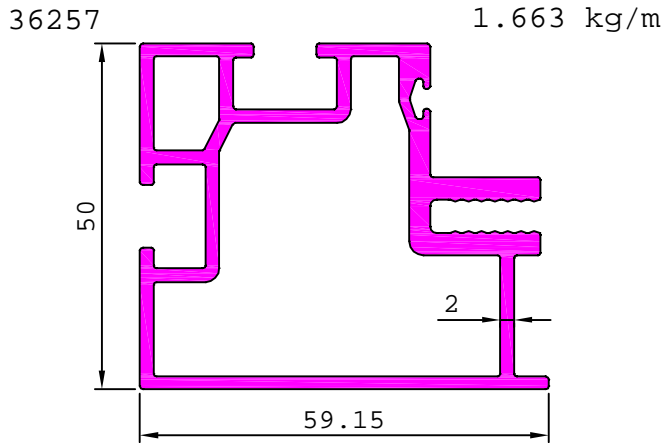

MATCHING WITH 36267

## CURTAIN WALL SECTION

36279 2.020 kg/m

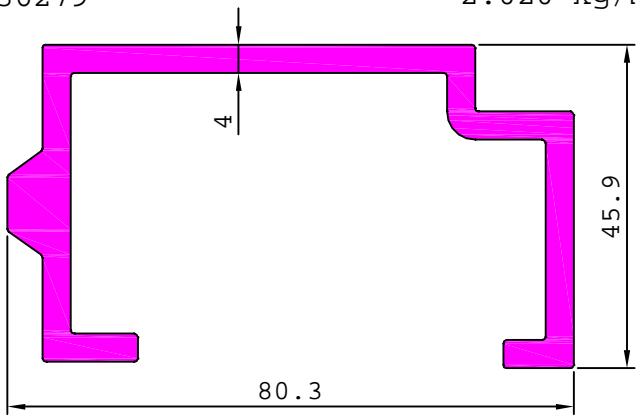

36281 1.562 kg/m

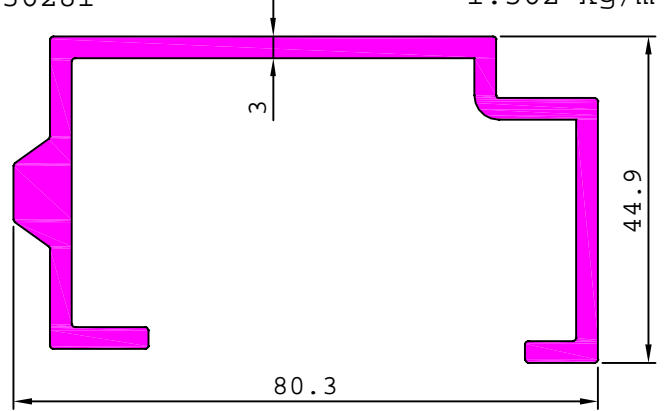

36293 1.054 kg/m

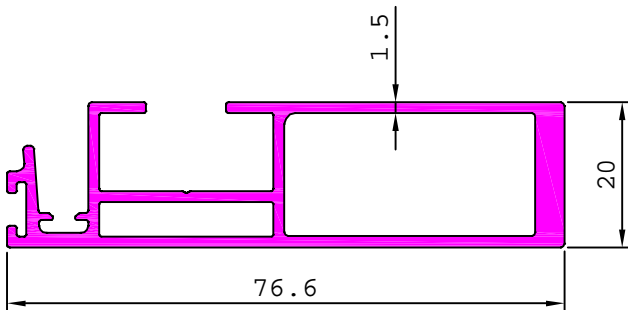

36371 0.880 kg/m

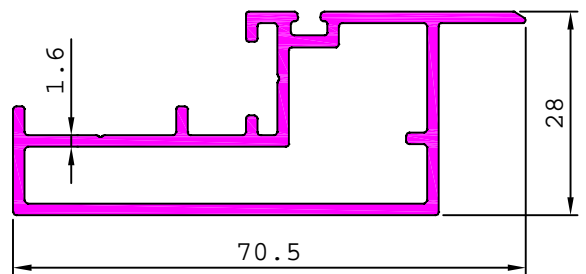

**MATCHING WITH 29073**

35665 0.605 kg/m

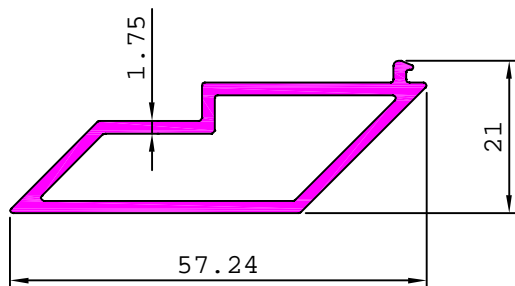

36323 2.723 kg/m

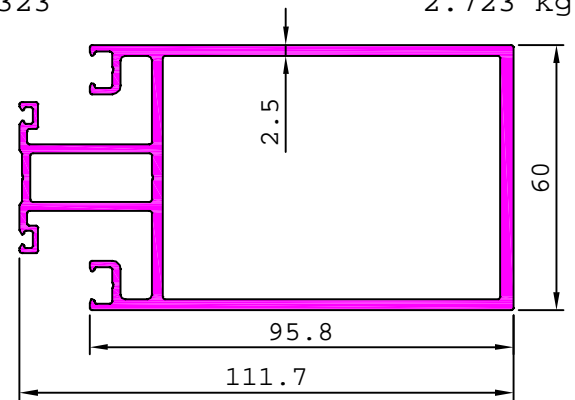

36282 0.393 kg/m

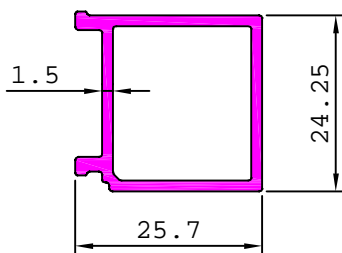

36293 1.054 kg/m

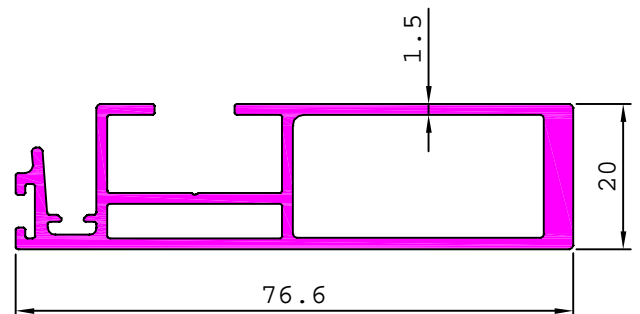

## CURTAIN WALL SECTION

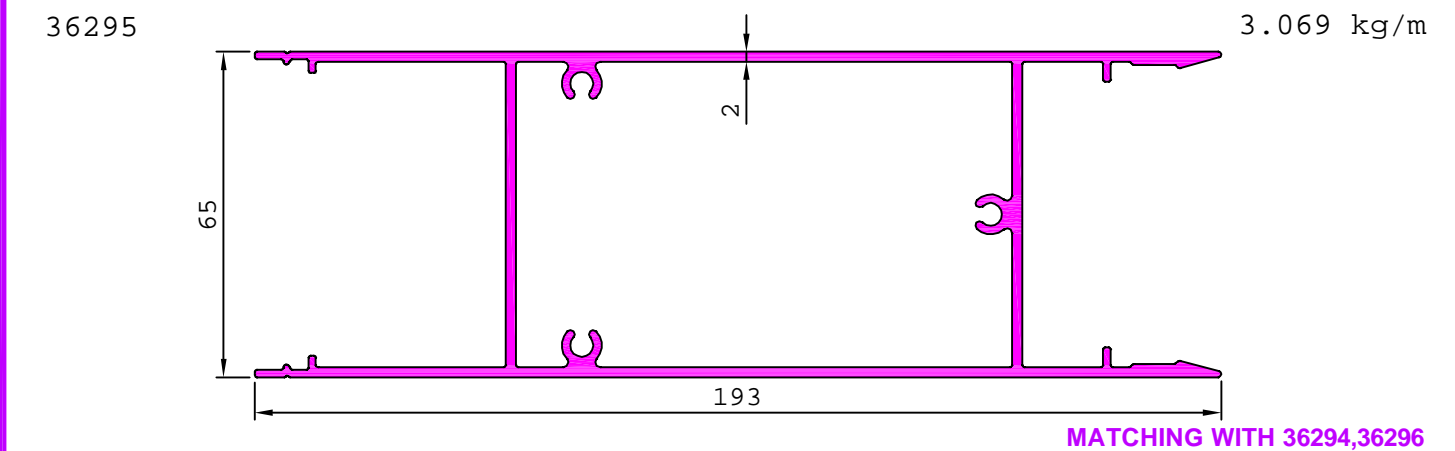
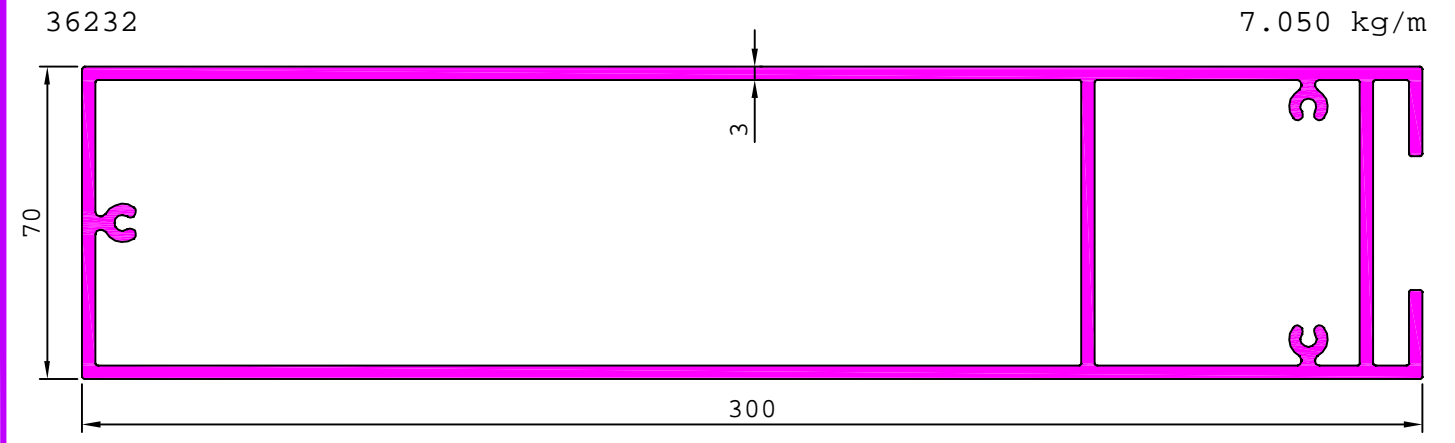

MATCHING WITH 36294,36296

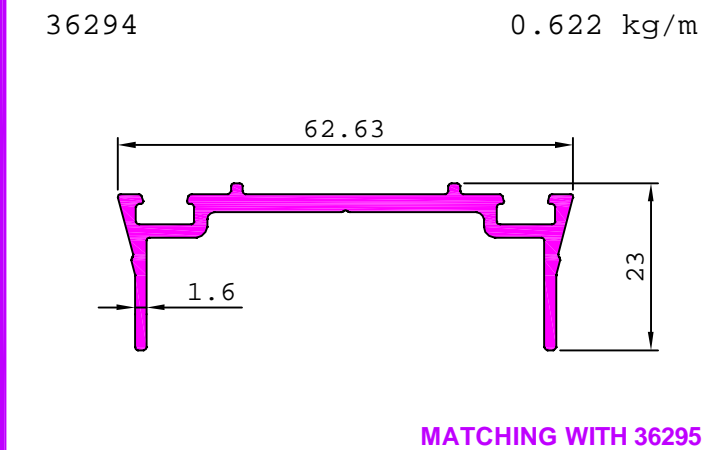

MATCHING WITH 36295

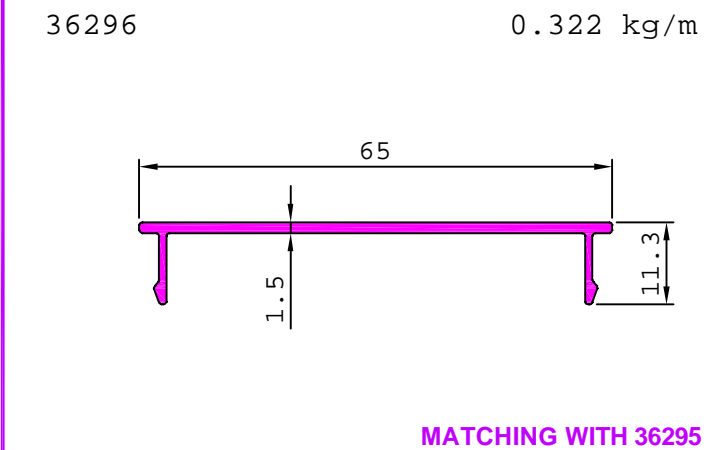

MATCHING WITH 36295

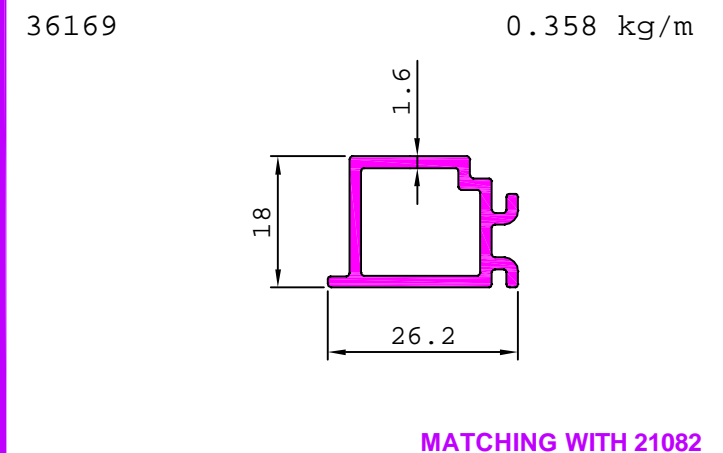

MATCHING WITH 21082

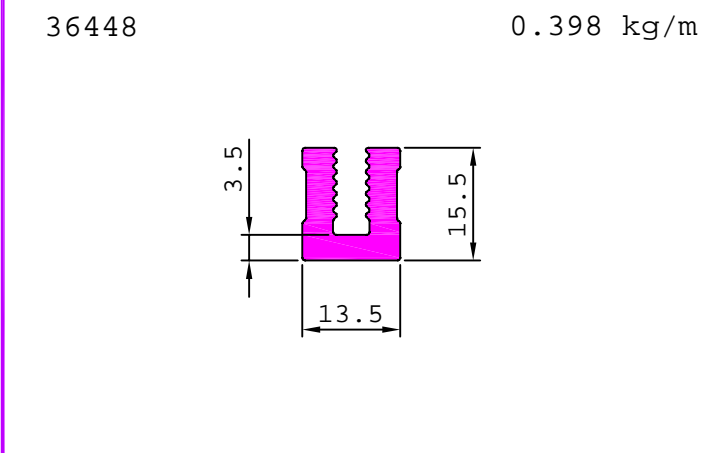

## CURTAIN WALL SECTION

36463 0.700 kg/m

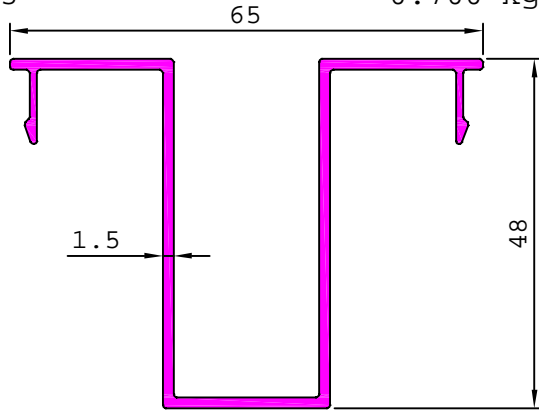

G100026 0.653 kg/m

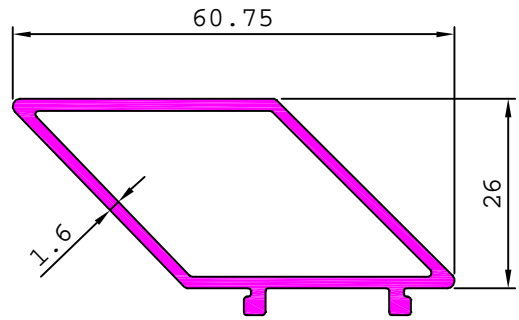

G100024 0.461 kg/m

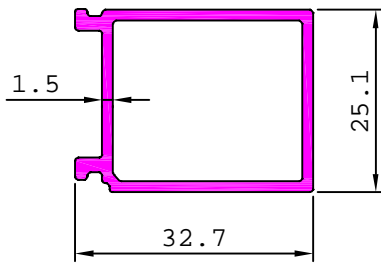

G100014 2.317 kg/m

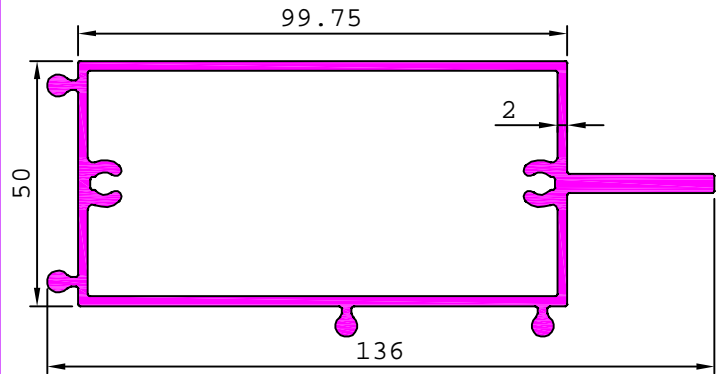

**MATCHING WITH G100015**

G100022 0.295 kg/m

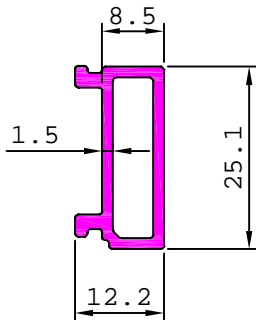

G100023 0.416 kg/m

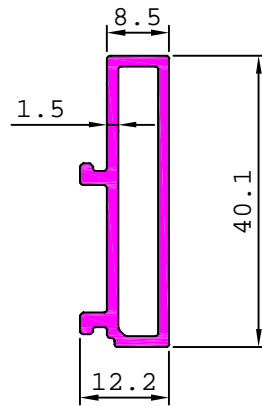

G100025 0.582 kg/m

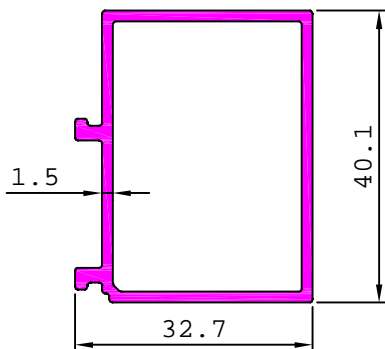

G100058 0.467 kg/m

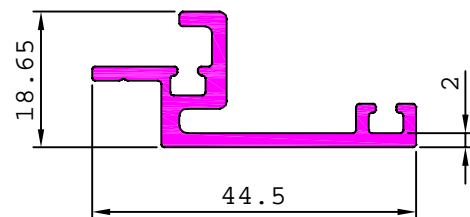

## CURTAIN WALL SECTION

G100015

6.422 kg/m

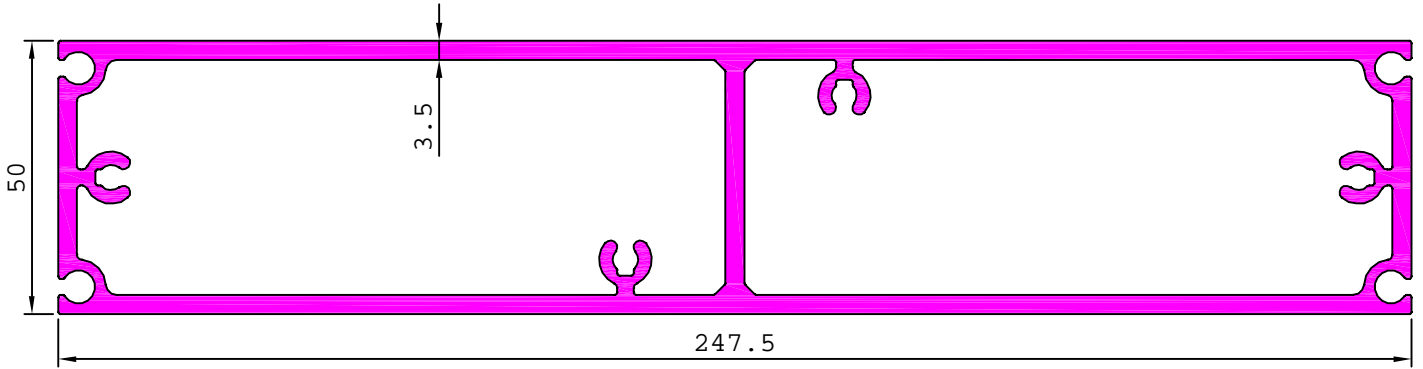

MATCHING WITH G100014

G100016

6.469 kg/m

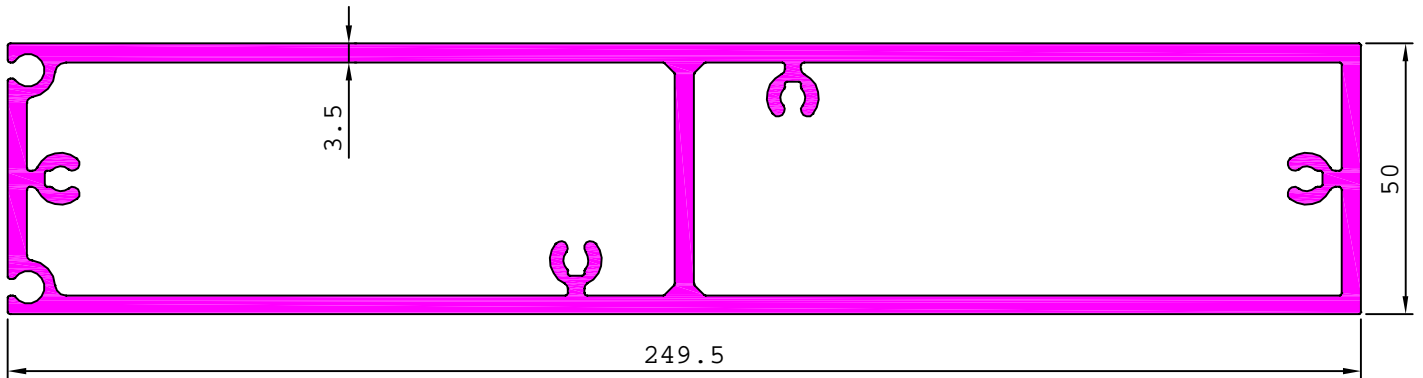

MATCHING WITH G100017

G100017

4.299 kg/m

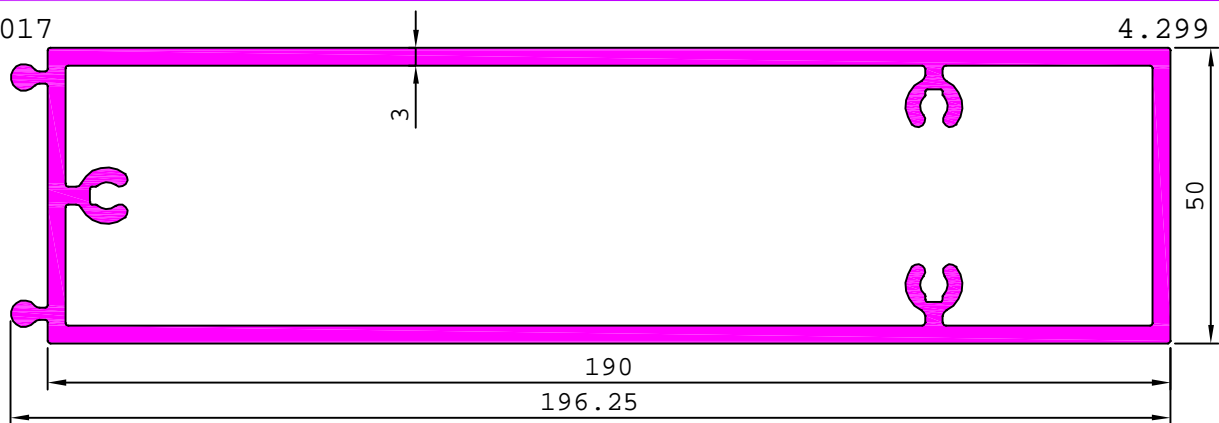

MATCHING WITH G100015

G100060

1.559 kg/m

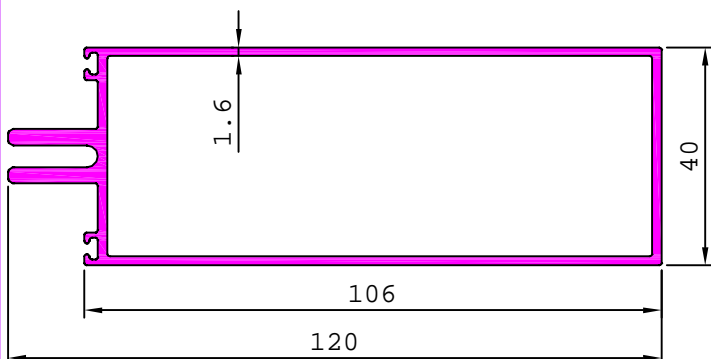

G100645

0.666 kg/m

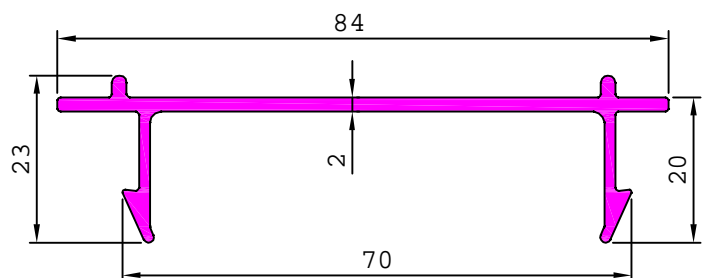

## CURTAIN WALL SECTION

G100059

2.329 kg/m

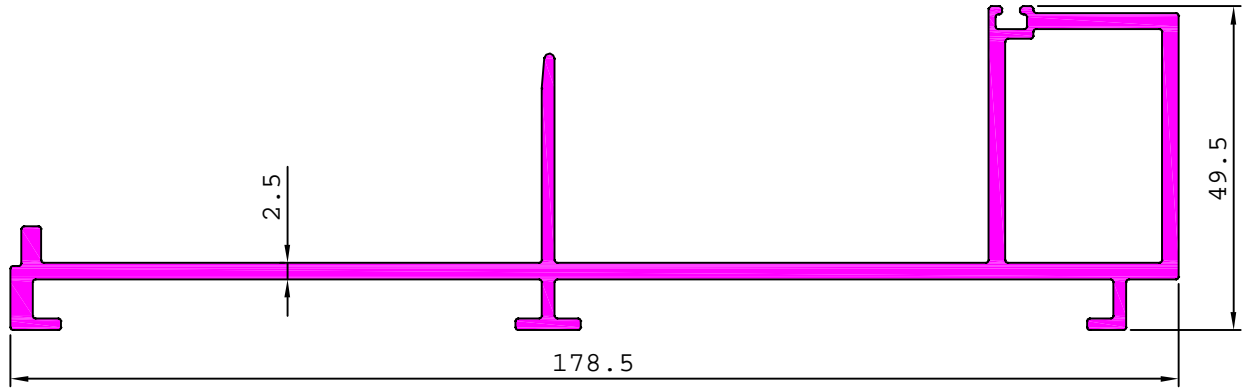

G100103

4.048 kg/m

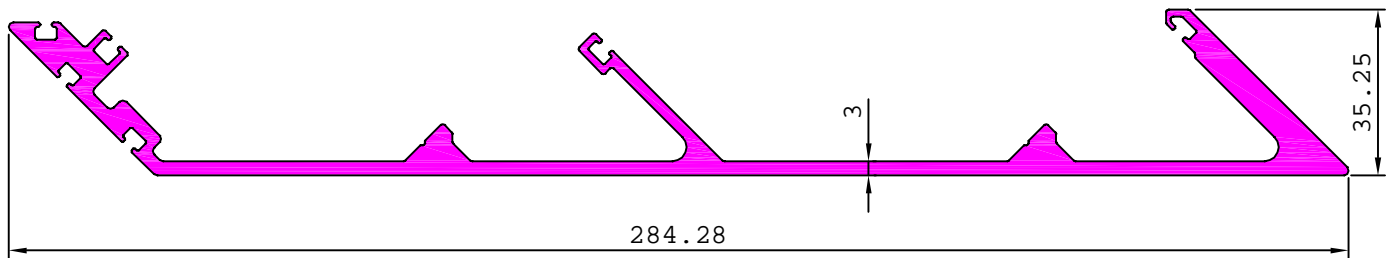

G100104

4.746 kg/m

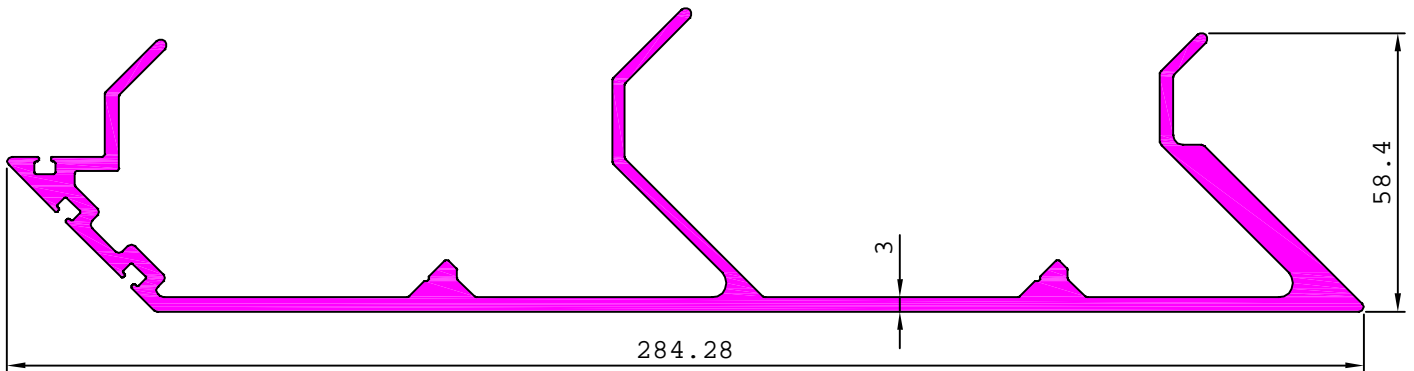

G100192

0.349 kg/m

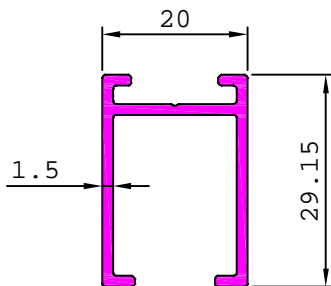

G100191

0.250 kg/m

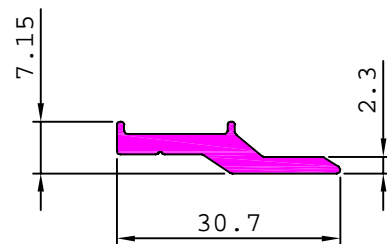

## CURTAIN WALL SECTION

G100187

1.438 kg/m

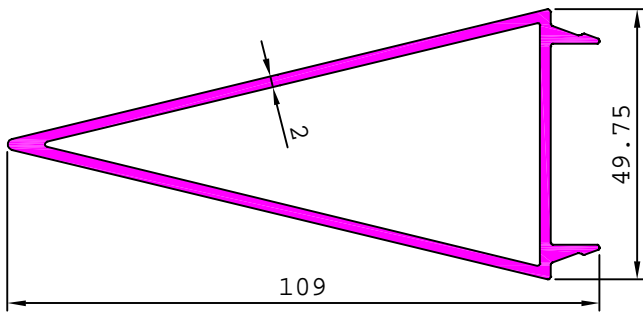

MATCHING WITH G100186

G100188

0.478 kg/m

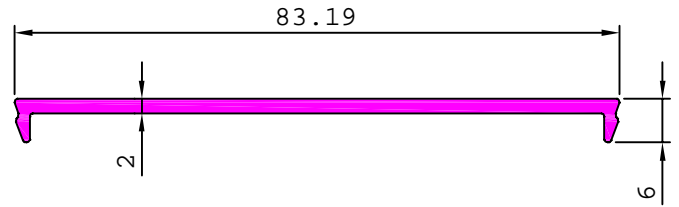

MATCHING WITH G100186

G100186

7.358 kg/m

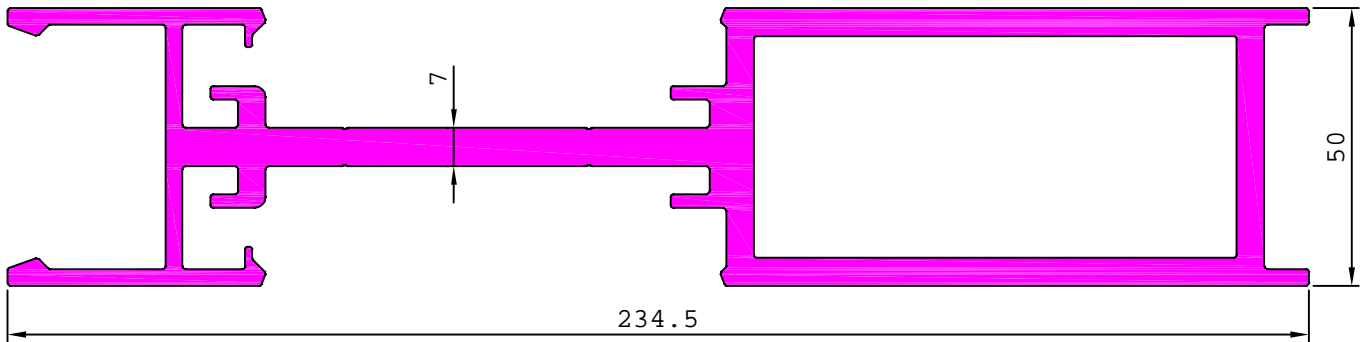

MATCHING WITH G100187 & G100188

G100180

4.555 kg/m

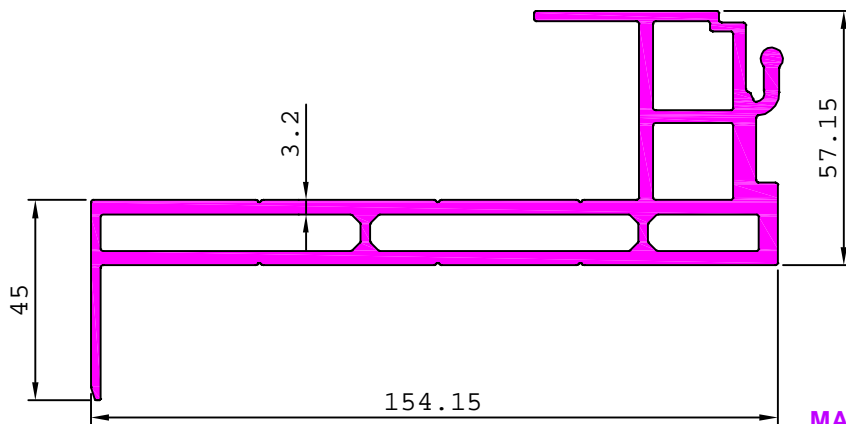

MATCHING WITH G100181

G100190

0.769 kg/m

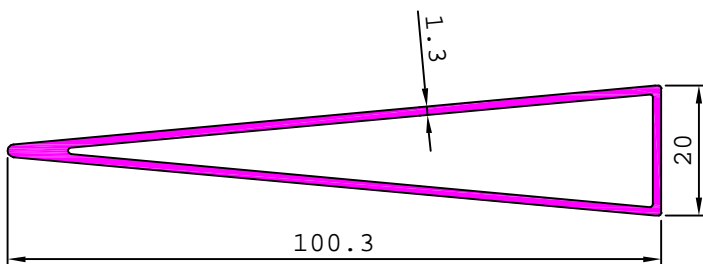

G100763

0.090 kg/m

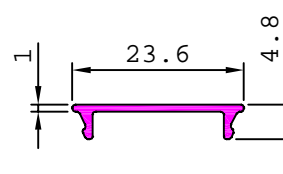

MATCHING WITH G100761

## CURTAIN WALL SECTION

G100181

3.266 kg/m

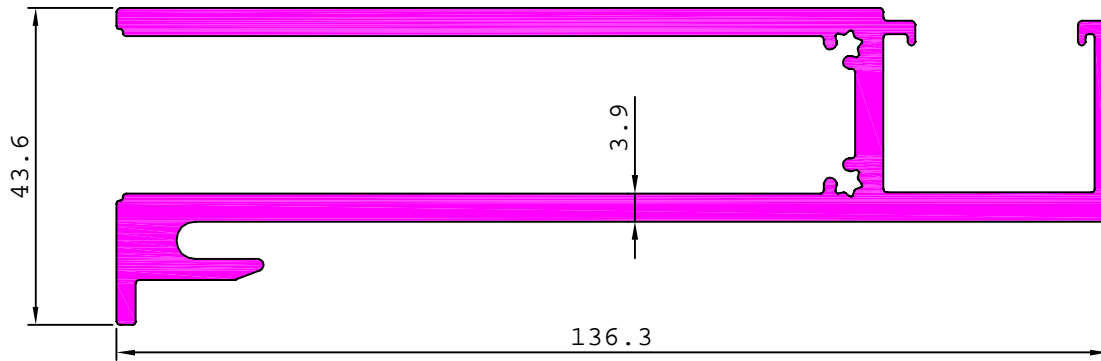

MATCHING WITH G100180

G100263

2.966 kg/m

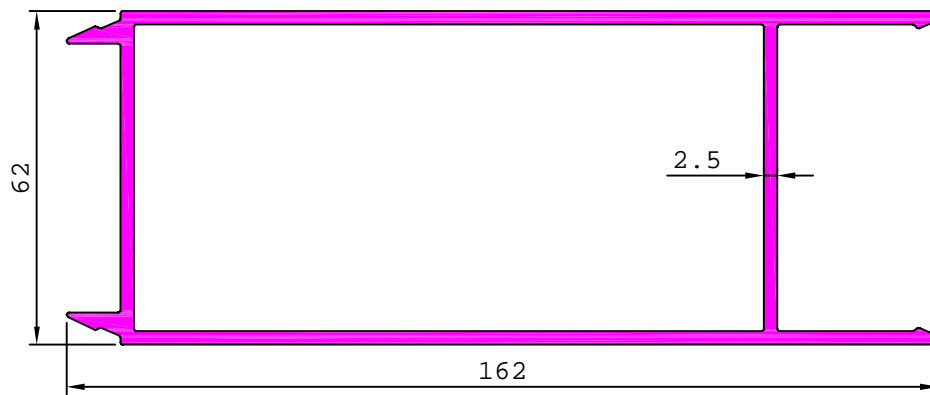

MATCHING WITH G100264,22709

G100264

2.796 kg/m

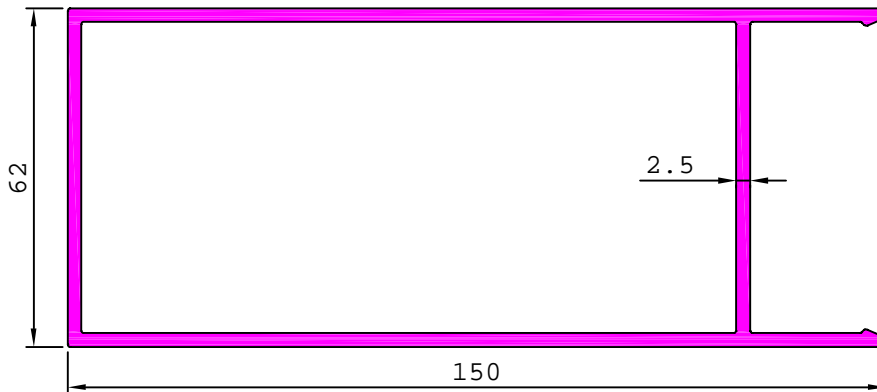

G100291

0.902 kg/m

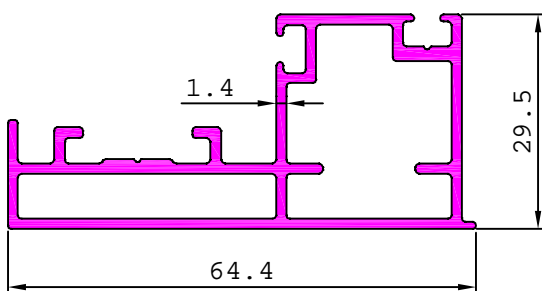

G100596

1.407 kg/m

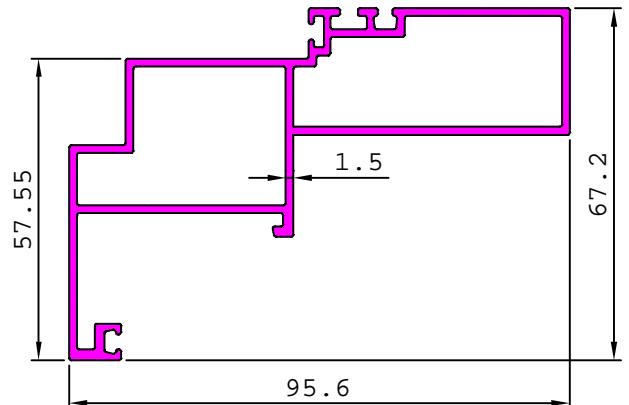

## CURTAIN WALL SECTION

G100760 1.790 kg/m

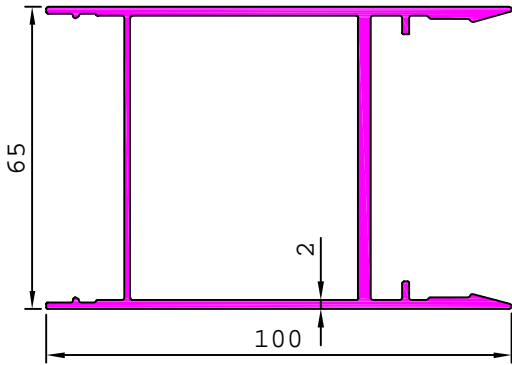

MATCHING WITH 36294,36296

G100782 0.665 kg/m

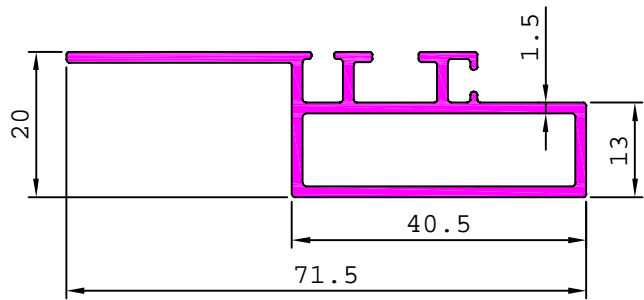

G100783

1.139 kg/m

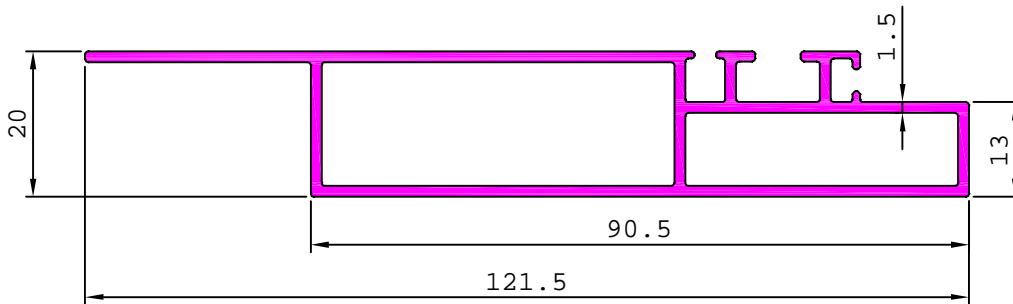

G100893 0.716 kg/m

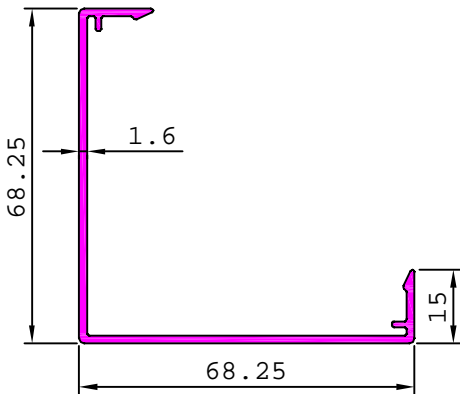

MATCHING WITH G100896

G100896 0.659 kg/m

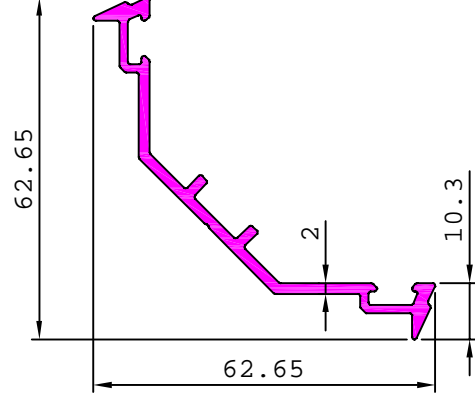

MATCHING WITH G100893

G100970

2.178 kg/m

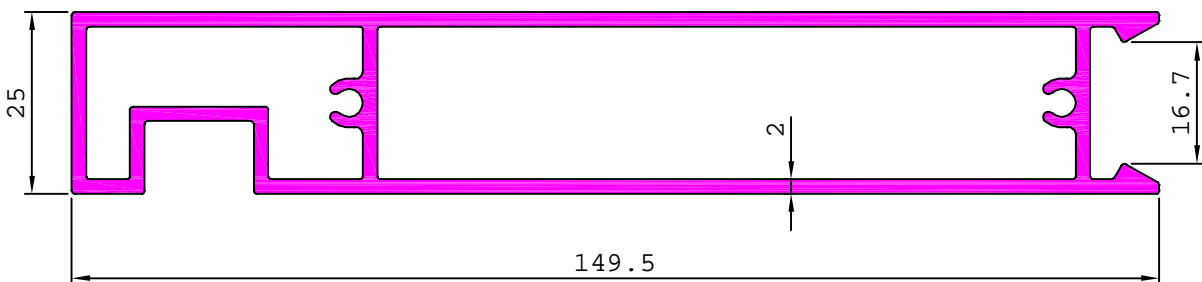

MATCHING WITH G100971

## CURTAIN WALL SECTION

G100971

3.472 kg/m

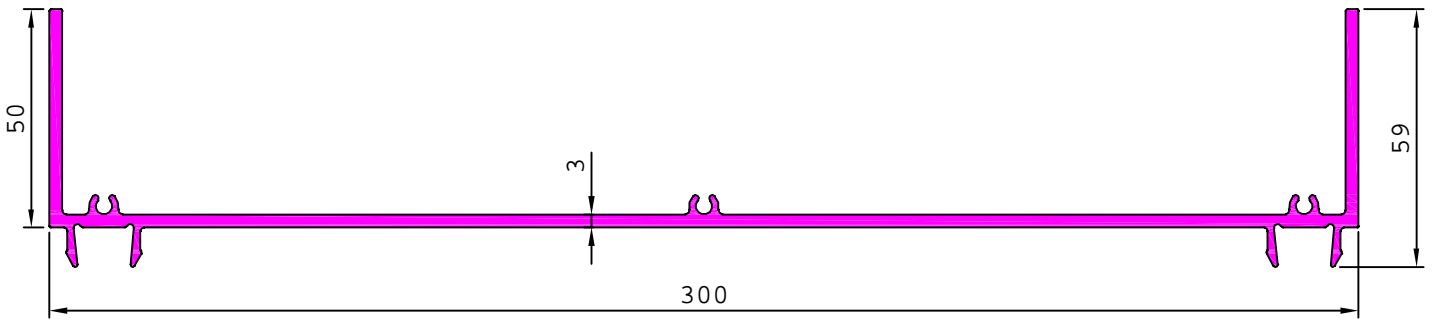

MATCHING WITH G100970

G100461

1.461 kg/m

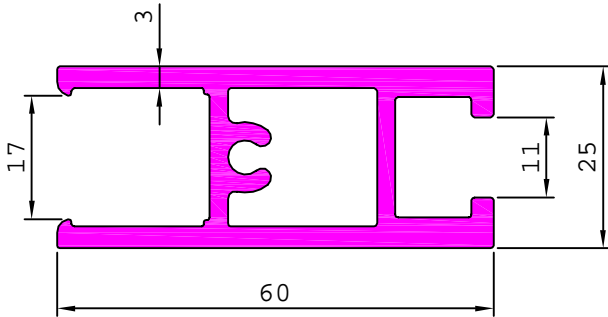

G101109

1.023 kg/m

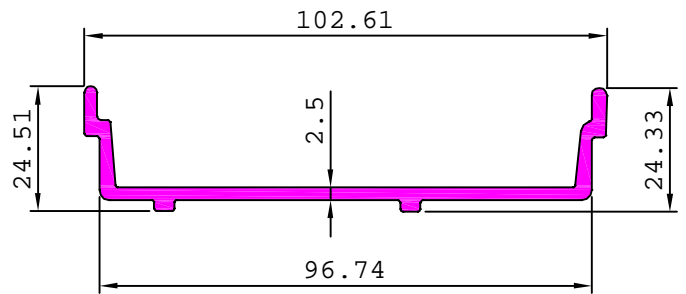

MATCHING WITH G101107

G101071

5.827 kg/m

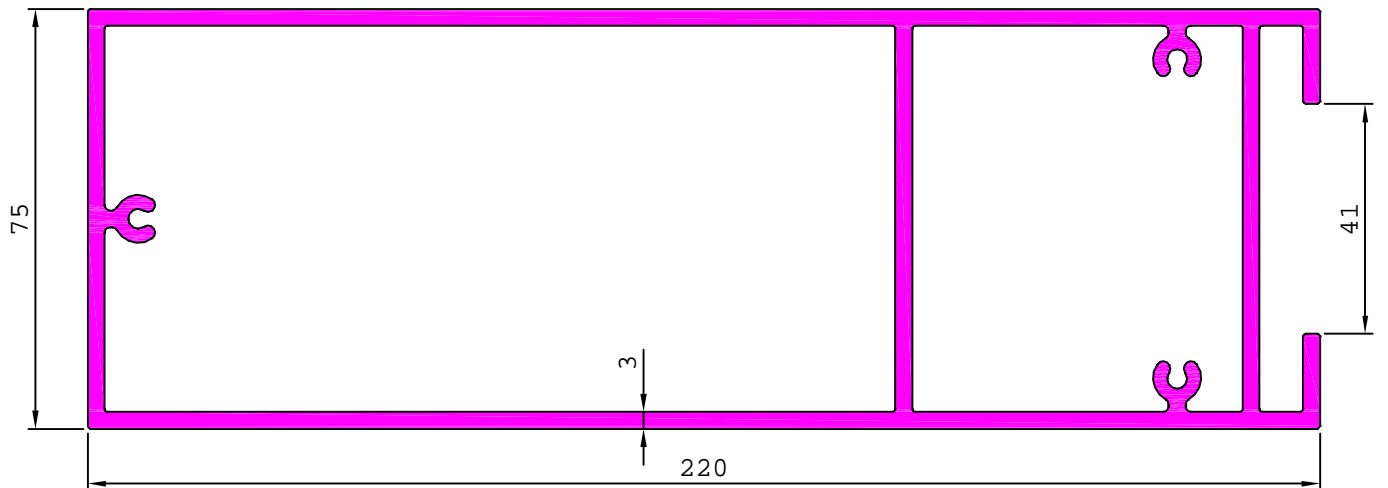

G101189

1.947 kg/m

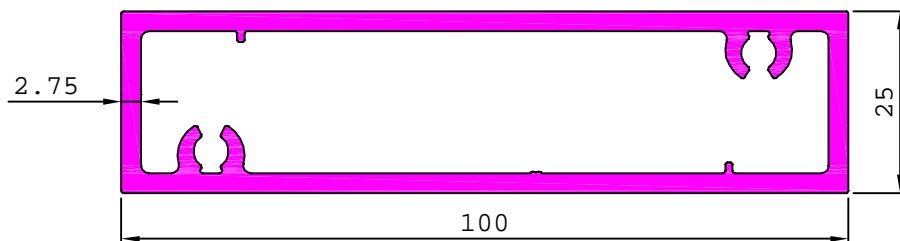

## CURTAIN WALL SECTION

G101441

4.002 kg/m

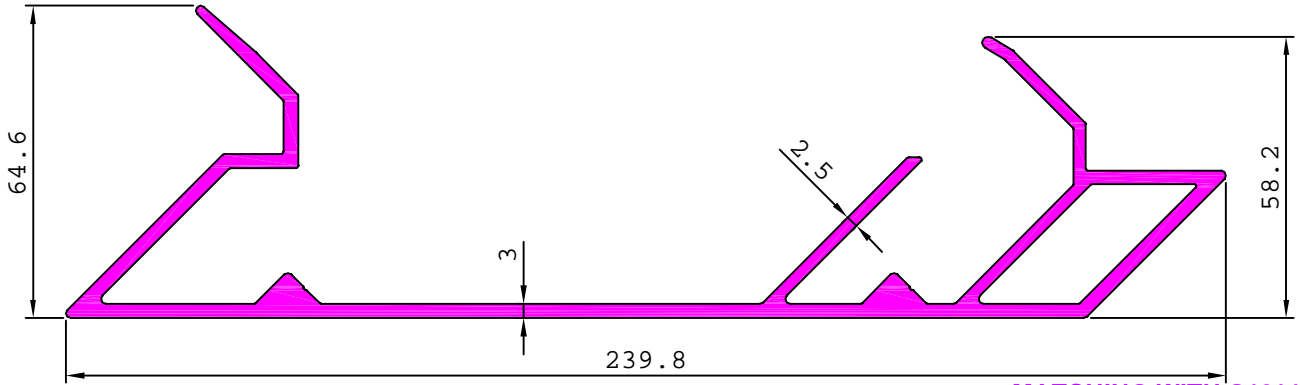

MATCHING WITH G101442

G101442

3.426 kg/m

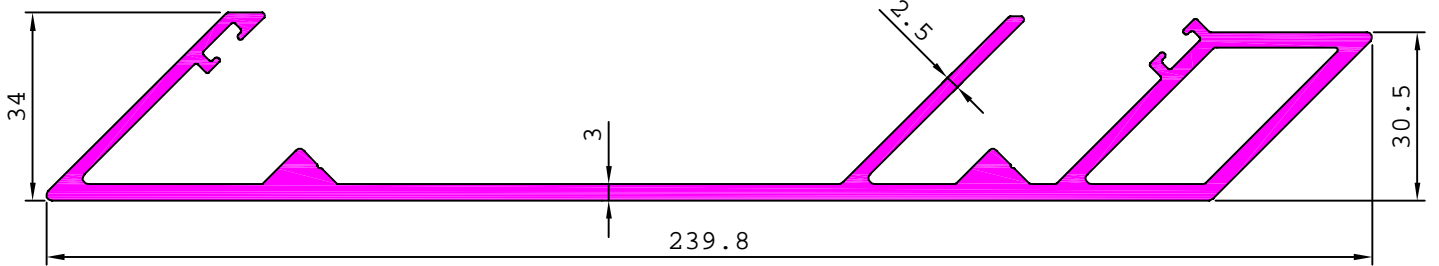

MATCHING WITH G101441

G101737

2.124 kg/m

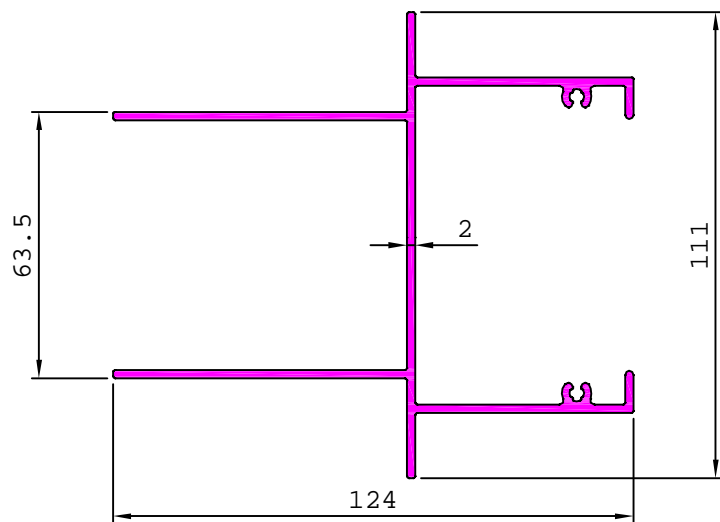

MATCHING WITH G101736

G100881

6.516 kg/m

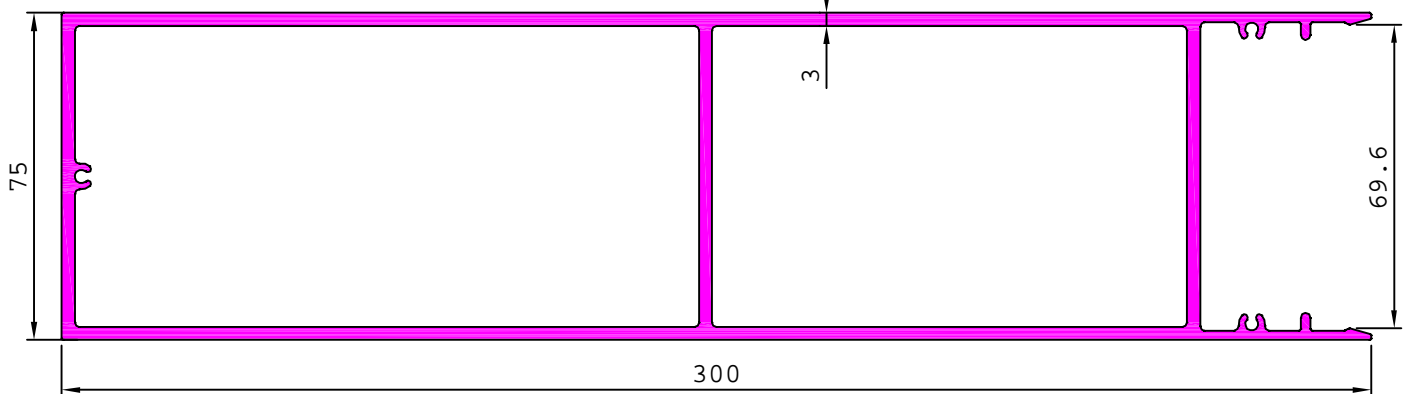

MATCHING WITH G100882

## CURTAIN WALL SECTION

G101744

6.114 kg/m

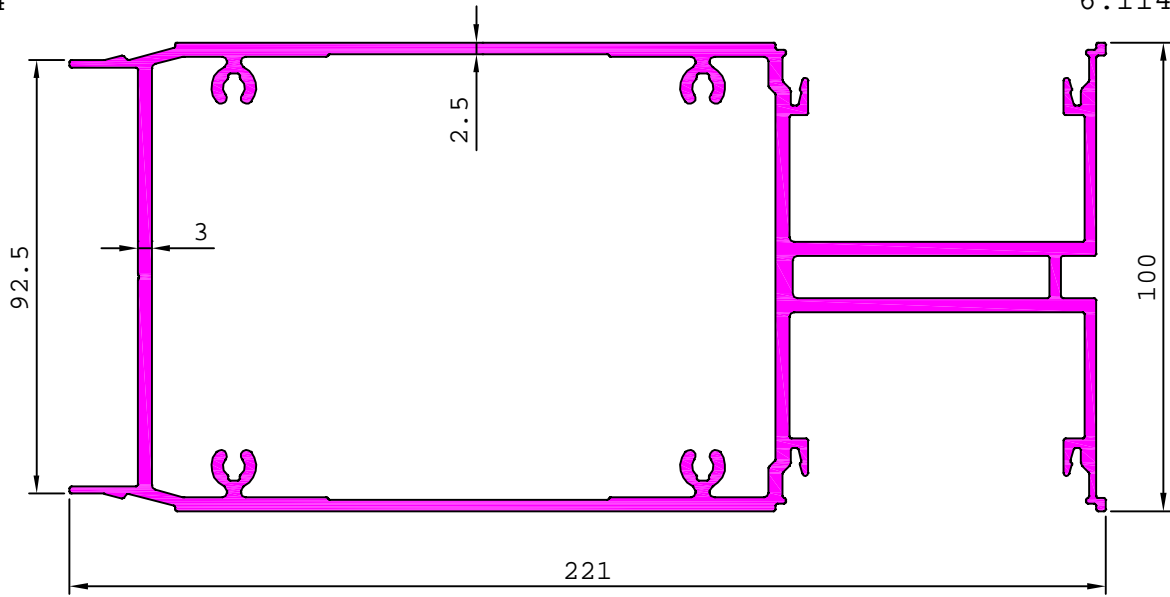

MATCHING WITH G101742,G101743.

G101294

6.596 kg/m

G101742

1.781 kg/m

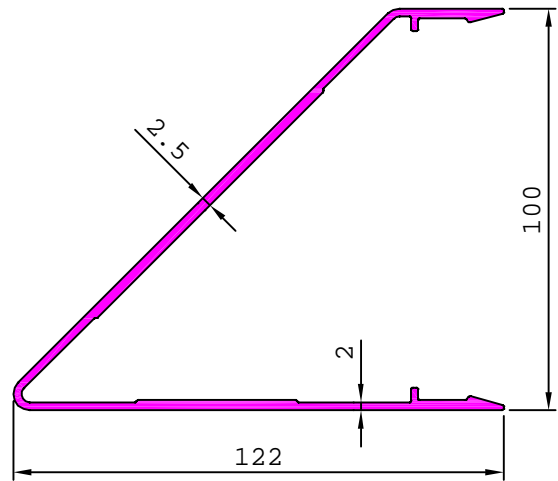
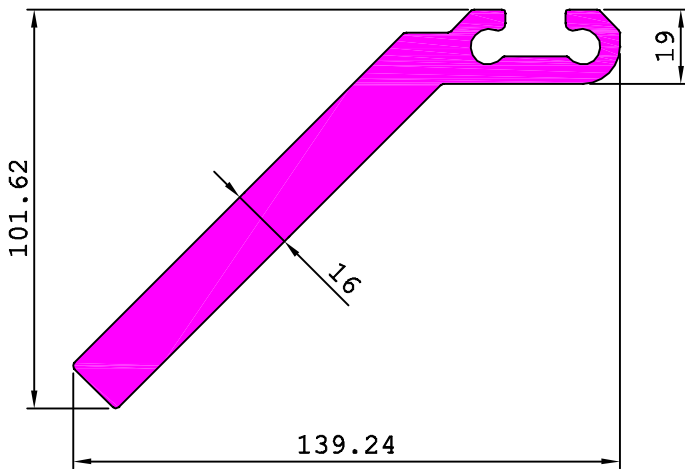

MATCHING WITH G101744,G101743.

G102711

2.868 kg/m

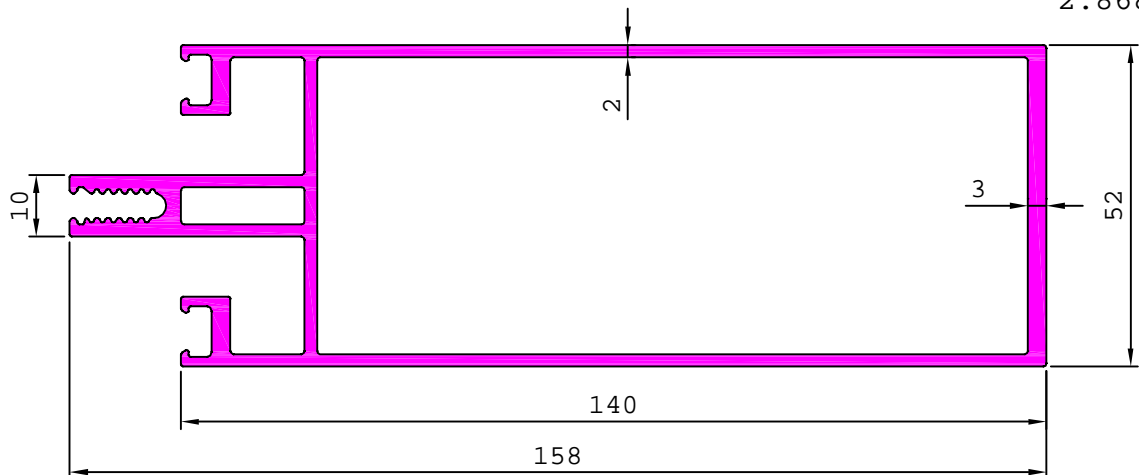

# CURTAIN WALL SECTION

G102715

3.453 kg/m



MATCHING WITH G102714

G102714

1.756 kg/m

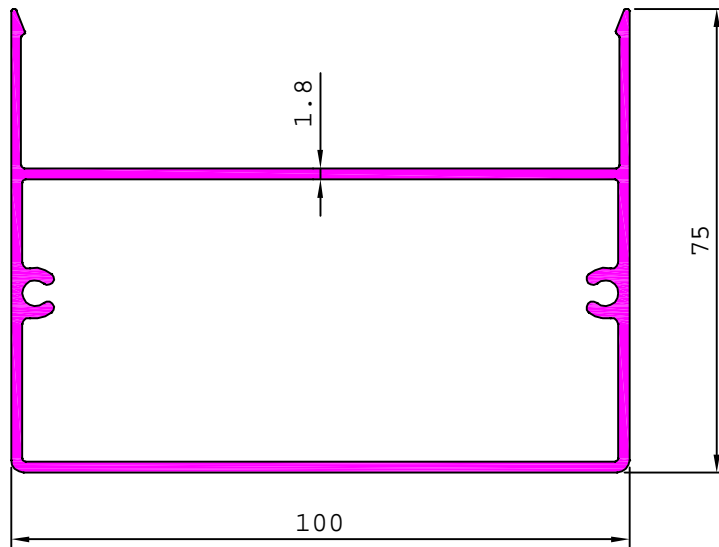

MATCHING WITH G102715

G102711

2.868 kg/m

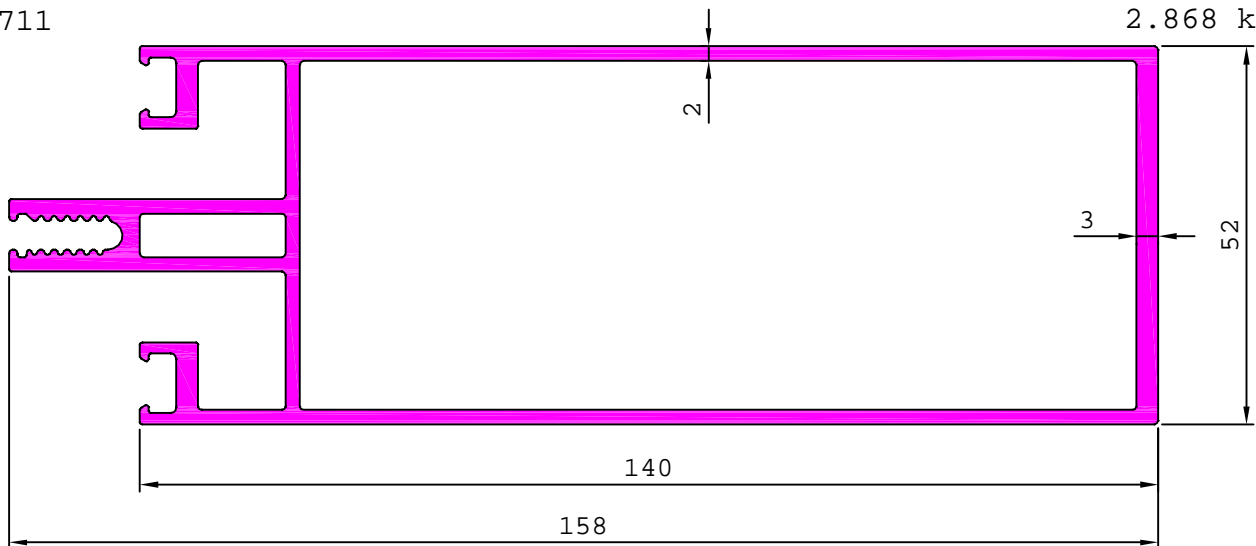

# CURTAIN WALL SECTION

G102713

2.500 kg/m

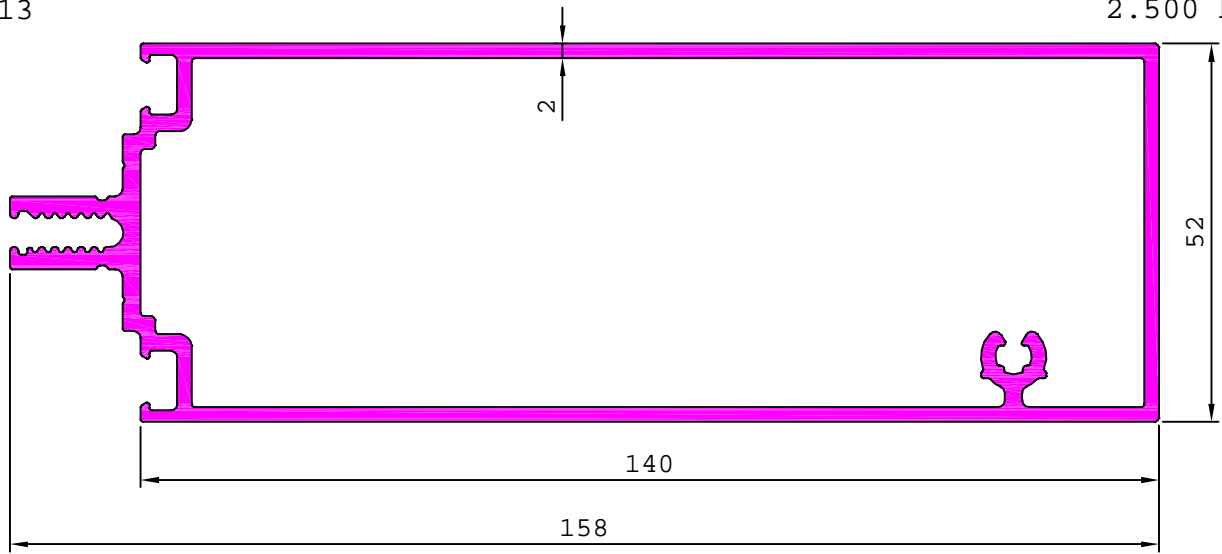

G102712

2.328 kg/m

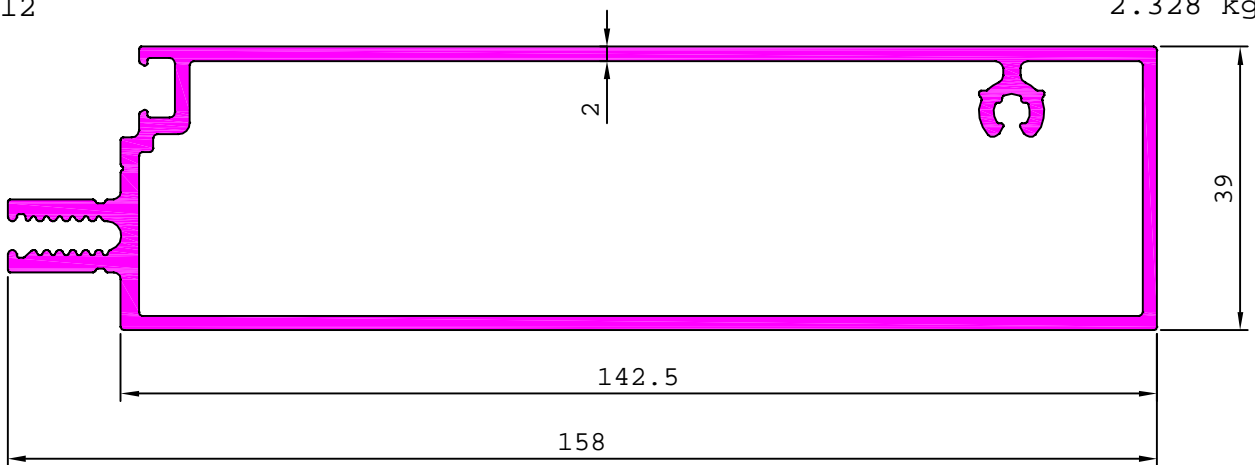

G102644

2.865 kg/m

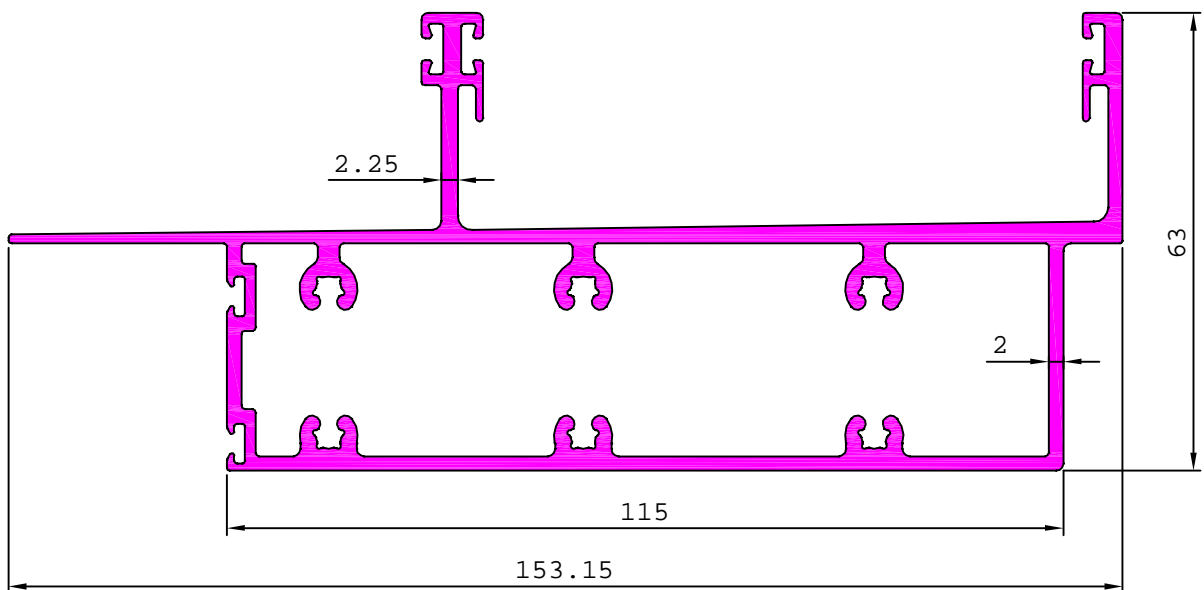

## CURTAIN WALL SECTION

G102653

1.441 kg/m

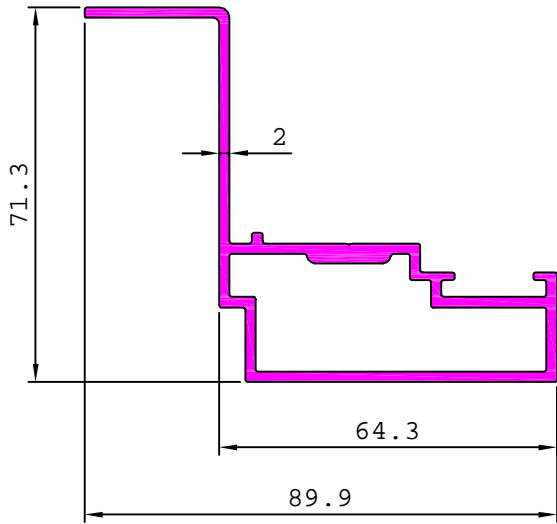

G102647

1.918 kg/m

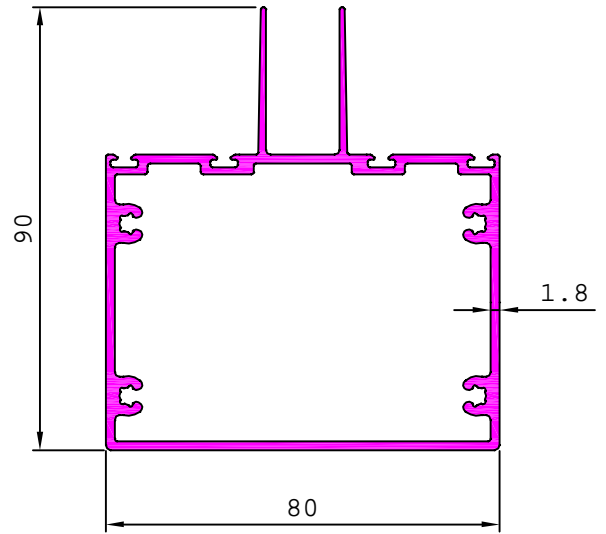

G102771

5.548 kg/m

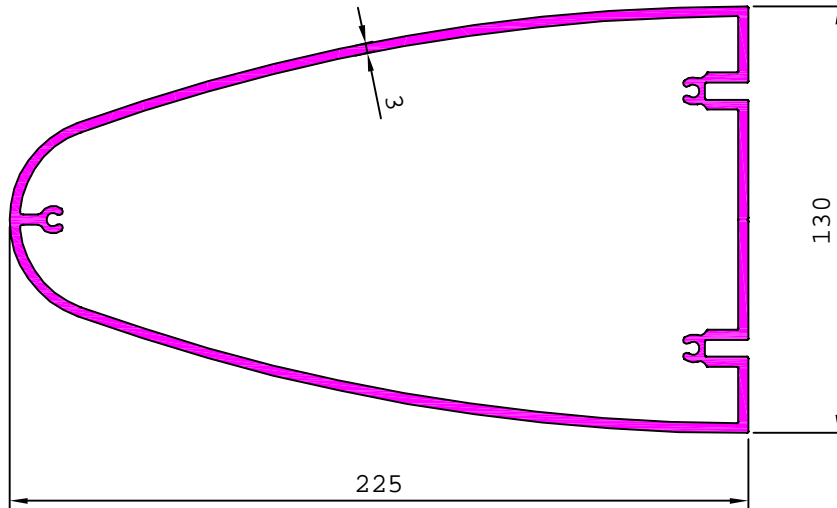

G102781

3.364 kg/m

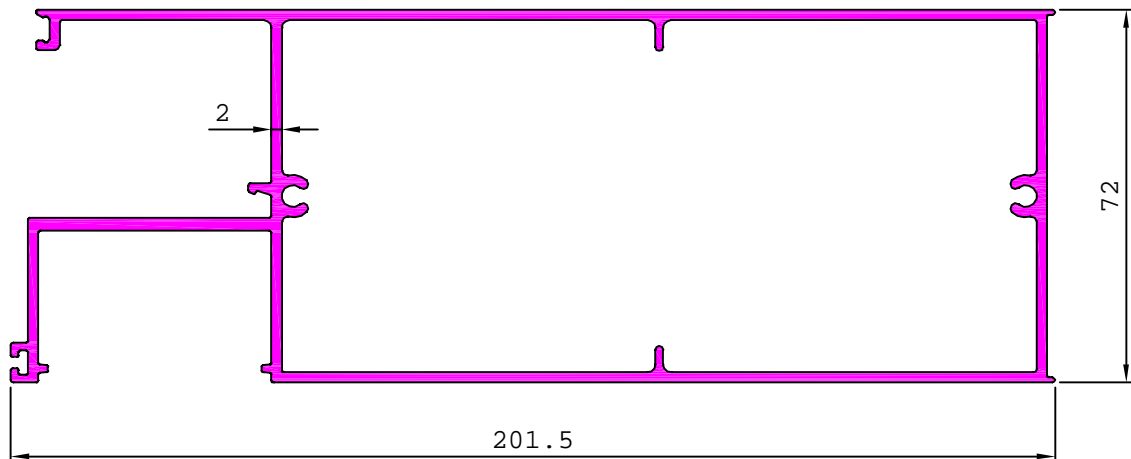

## CURTAIN WALL SECTION

G102777

2.522 kg/m

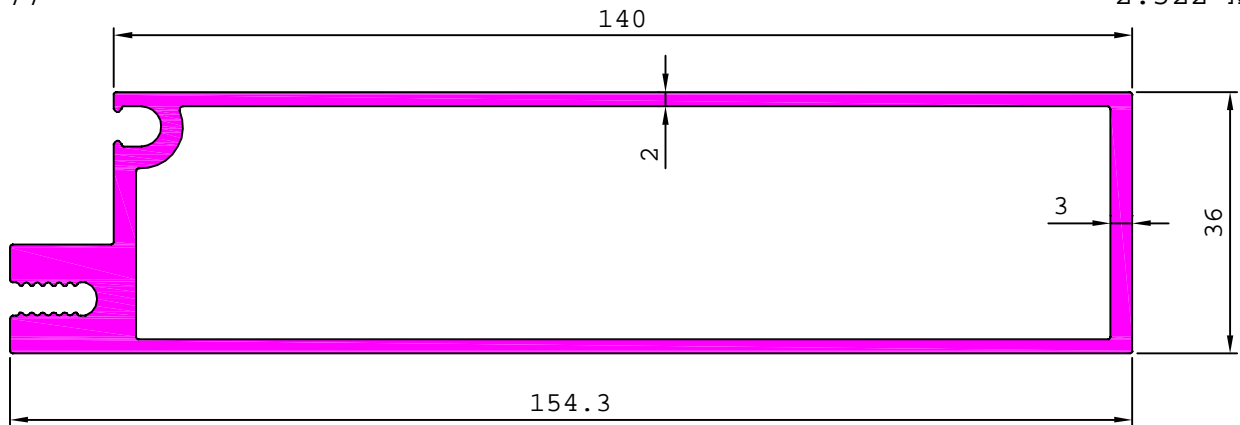

G102770

2.302 kg/m

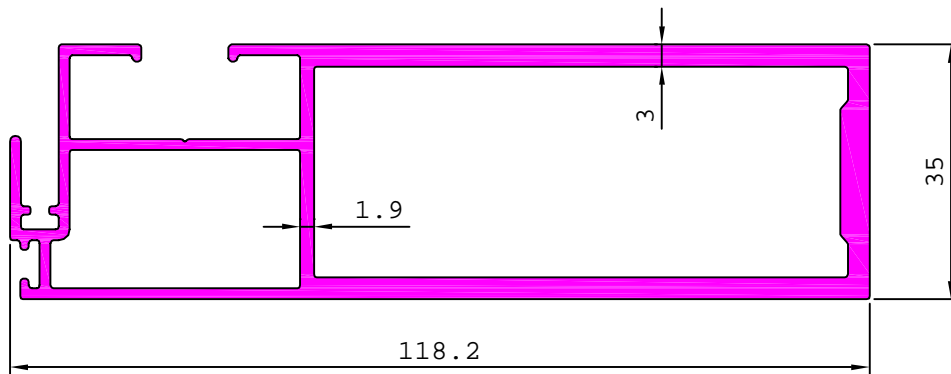

G102756

0.235 kg/m

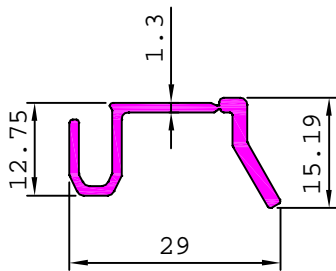

G102757

0.402 kg/m

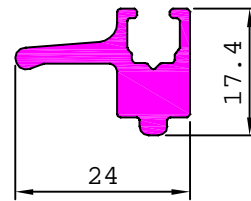

# CURTAIN WALL SECTION

G101099

1.351 kg/m

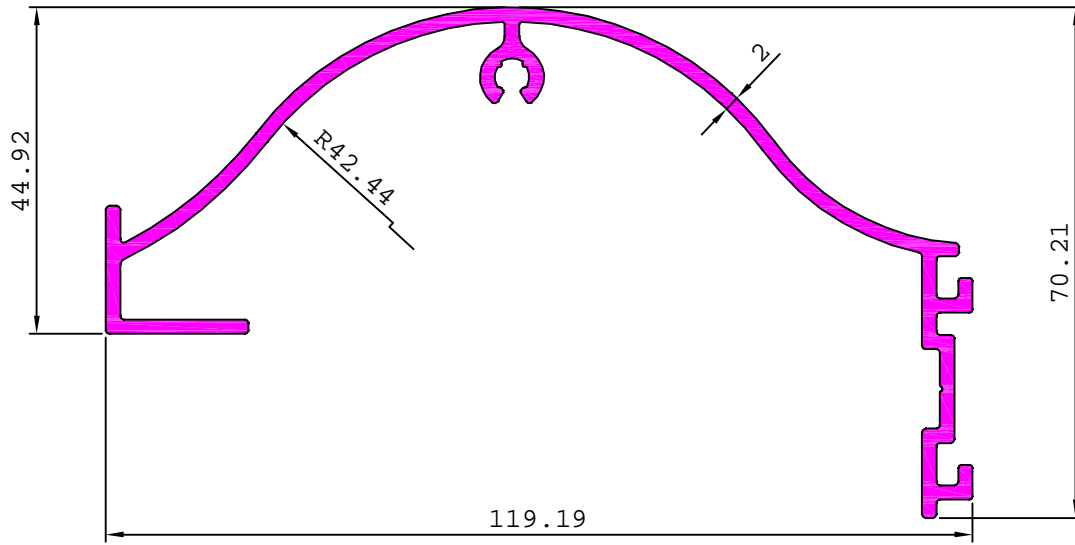

MATCHING WITH G101100,G101114

G101100

1.552 kg/m

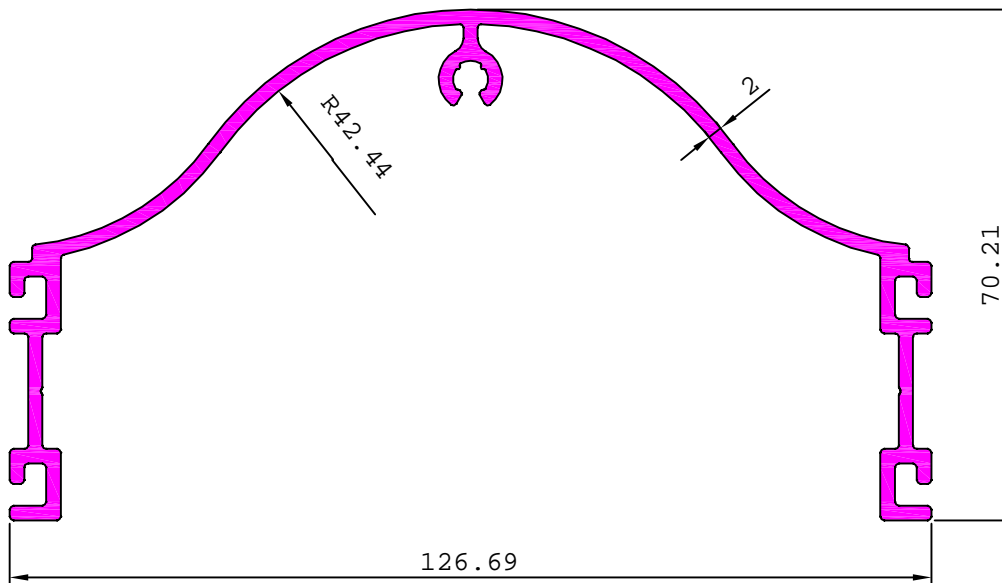

MATCHING WITH G101099

G101181

1.718 kg/m

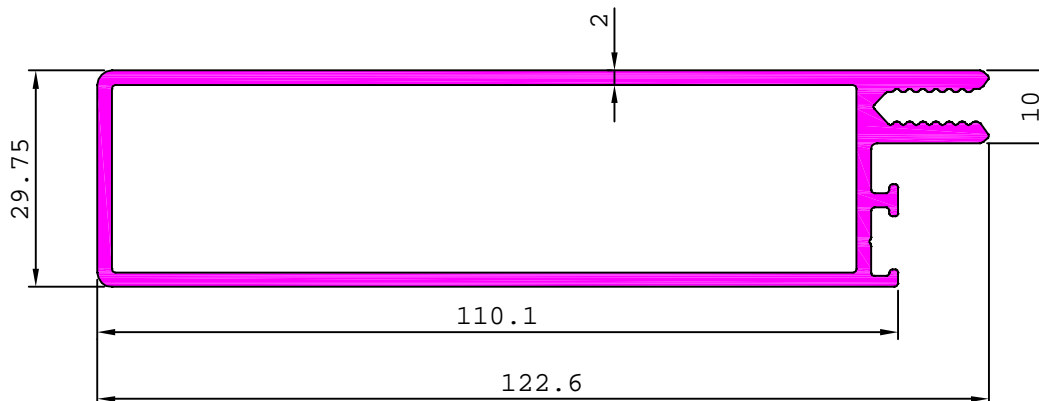

# CURTAIN WALL SECTION

G101116

3.286 kg/m

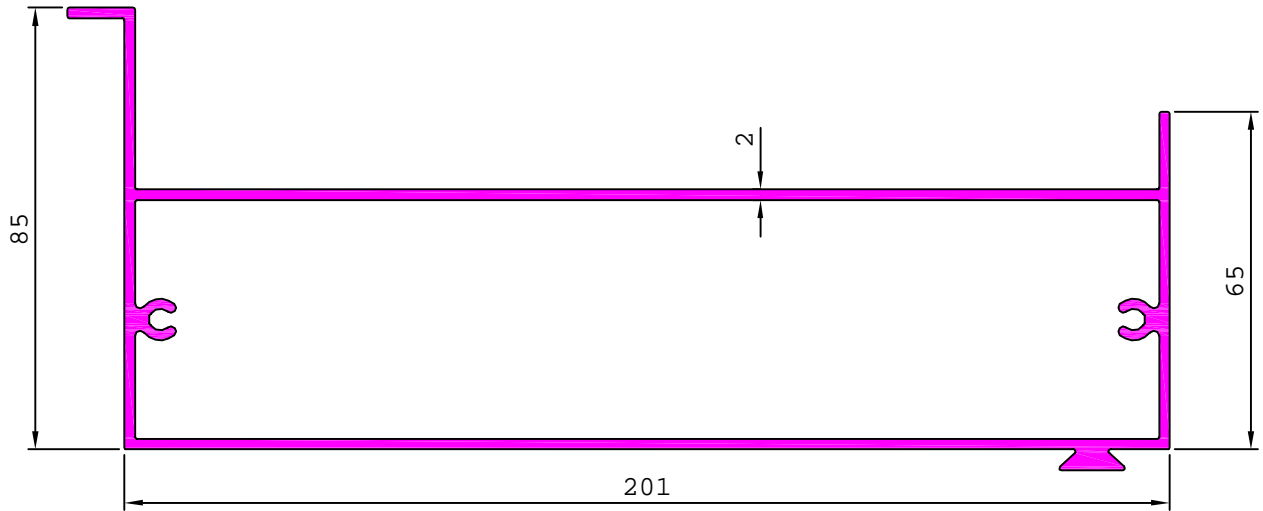

MATCHING WITH G101117

G101577

3.757 kg/m

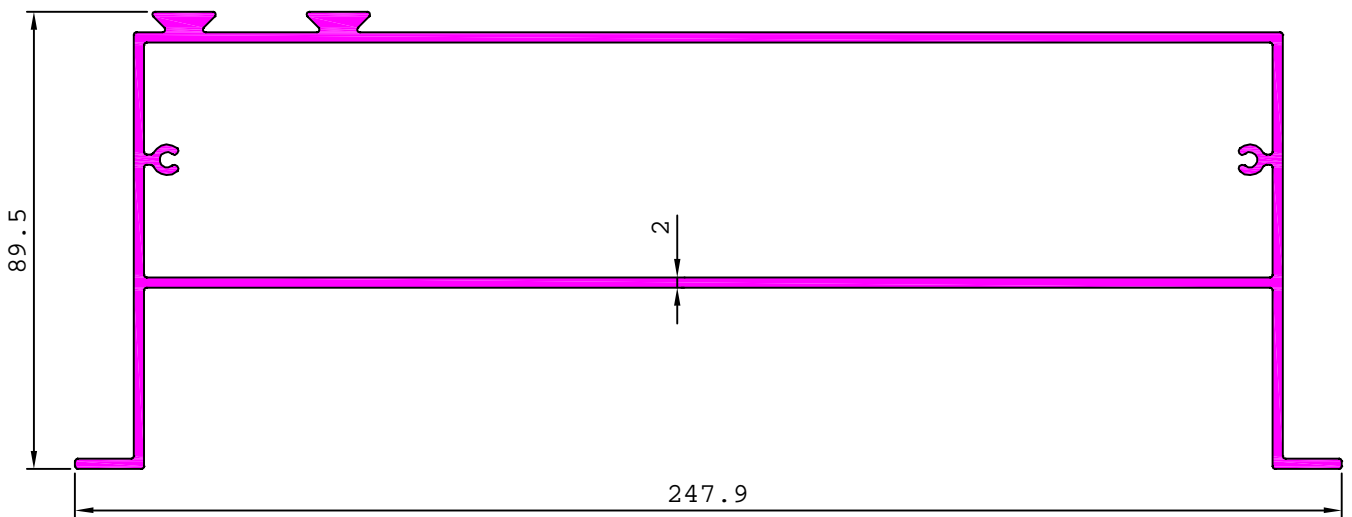

MATCHING WITH G101117

G101569

2.448 kg/m

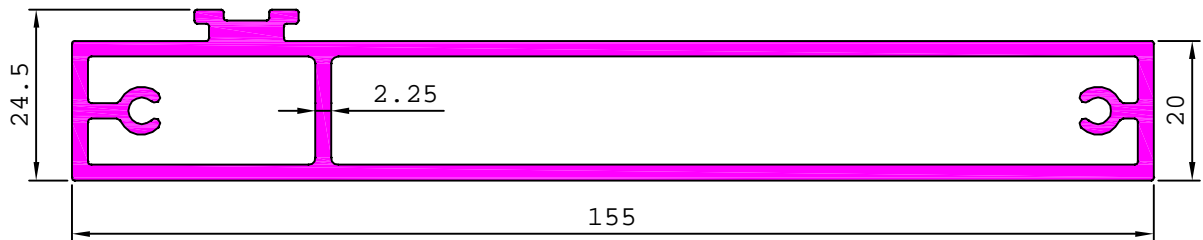

MATCHING WITH G101570

G101570

3.738 kg/m

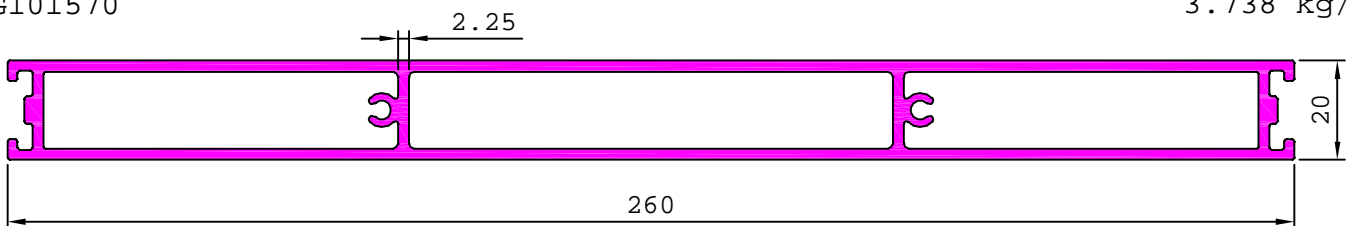

MATCHING WITH G101569

# CURTAIN WALL SECTION

G101290

4.154 kg/m

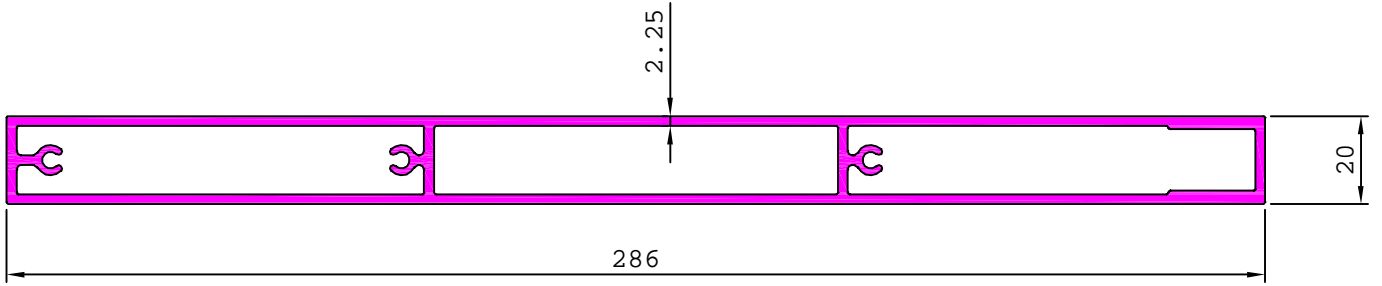

G101297

0.653 kg/m

G101298

0.674 kg/m

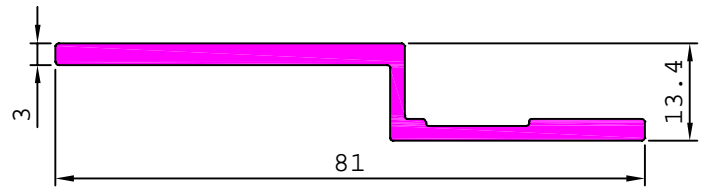
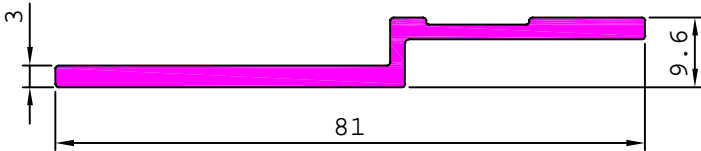

G101436

3.737 kg/m

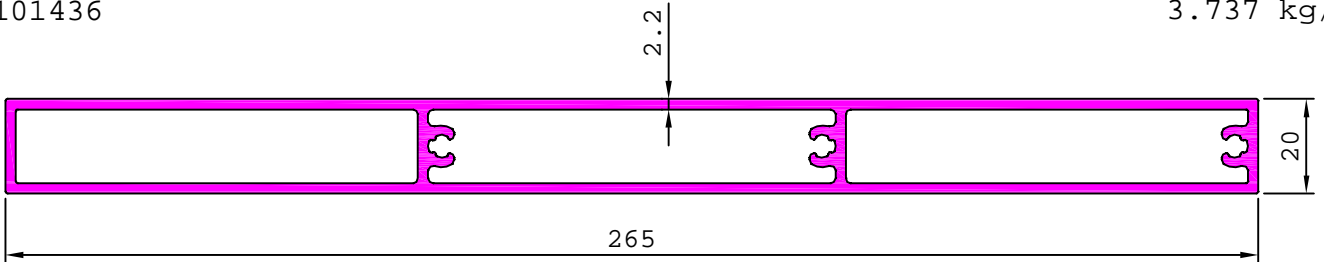

G101437

2.325 kg/m

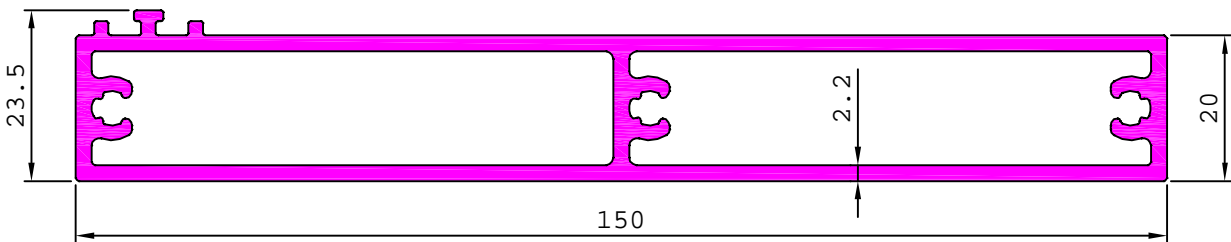

MATCHING WITH G101438

G101438

3.595 kg/m

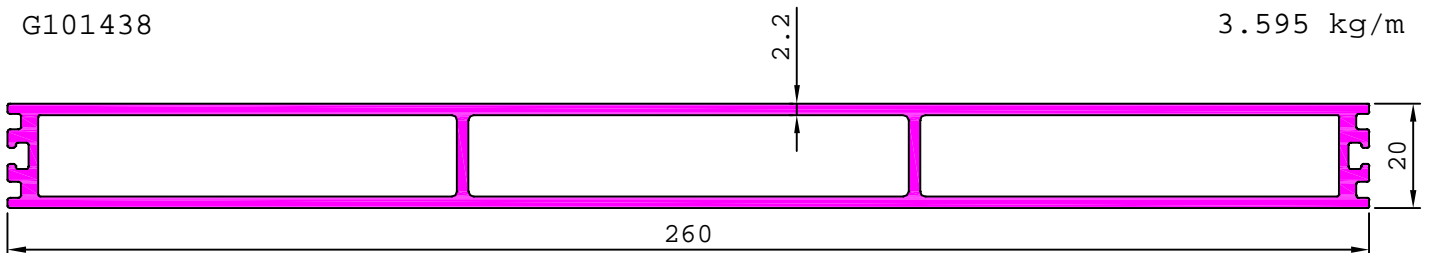

MATCHING WITH G101437

## CURTAIN WALL SECTION

G101215

2.932 Kg/m

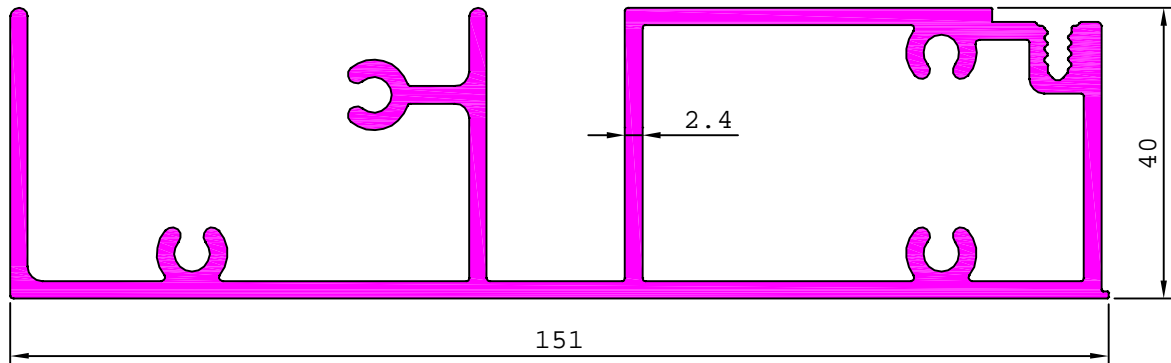

MATCHING WITH G101238

G101213

2.989 kg/m

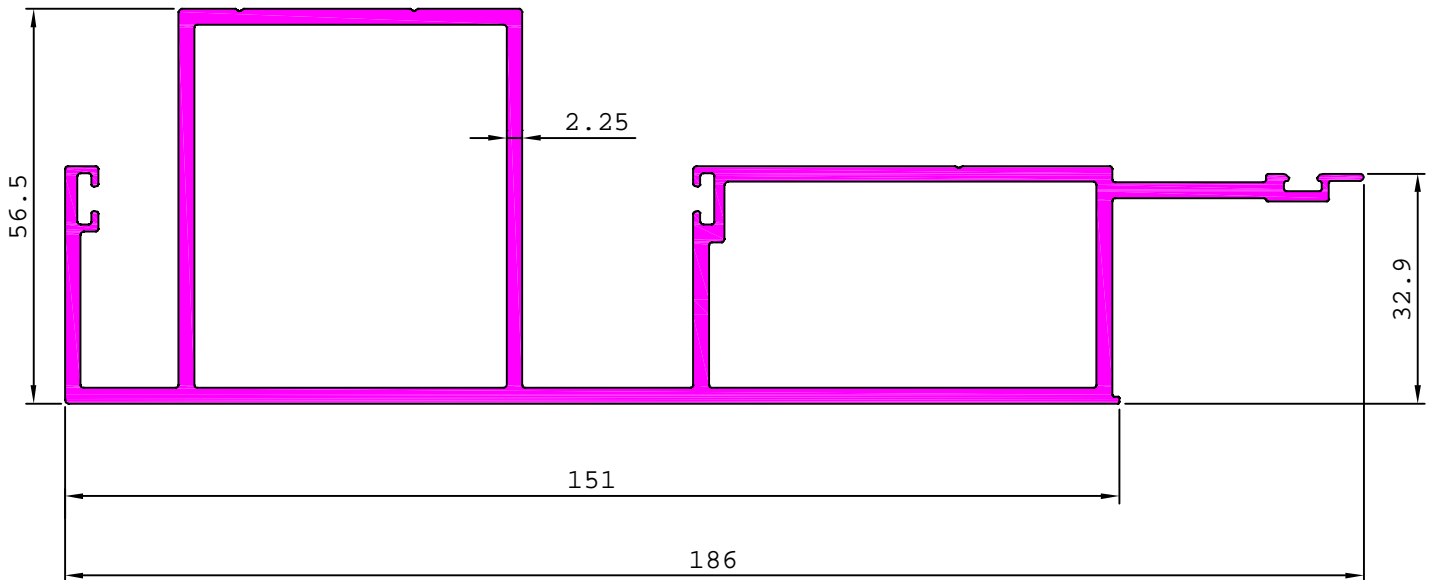

G101889

6.270 kg/m

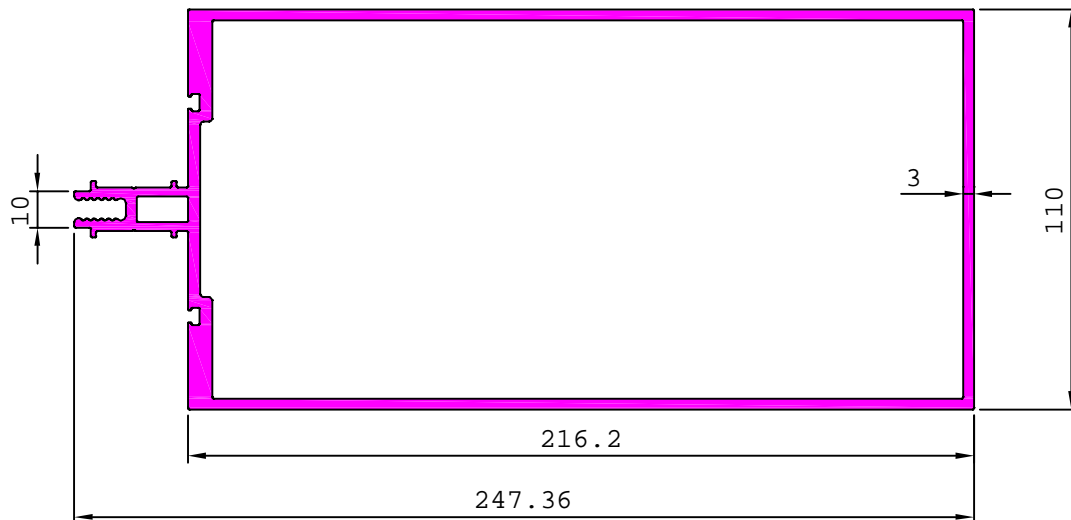

MATCHING WITH G101890,29073

## CURTAIN WALL SECTION

G101888

7.769 kg/m

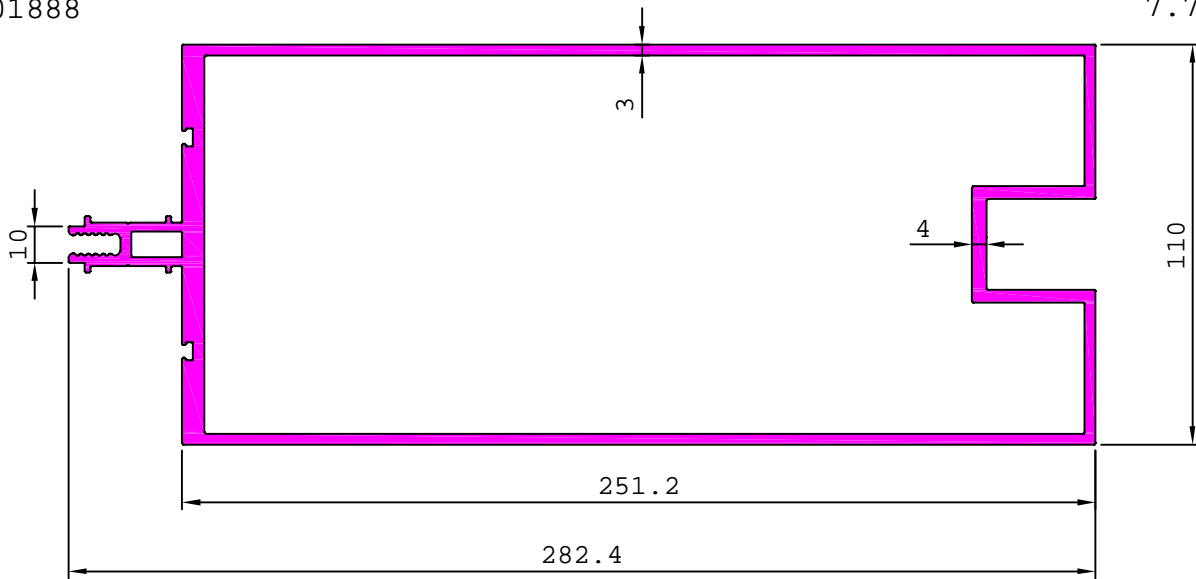

MATCHING WITH G101890,29073

G101886

2.909 kg/m

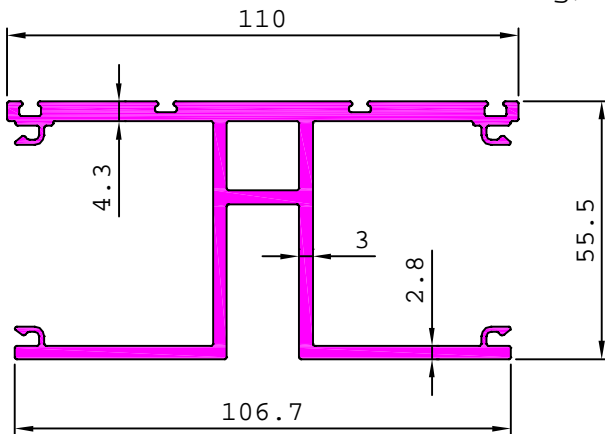

MATCHING WITH G101887

G101890

1.062 kg/m

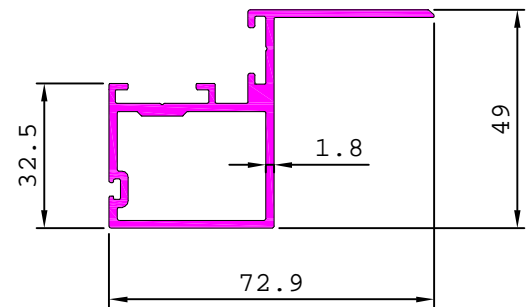

MATCHING WITH G101888,G101889,29073

G102014

3.695 kg/m

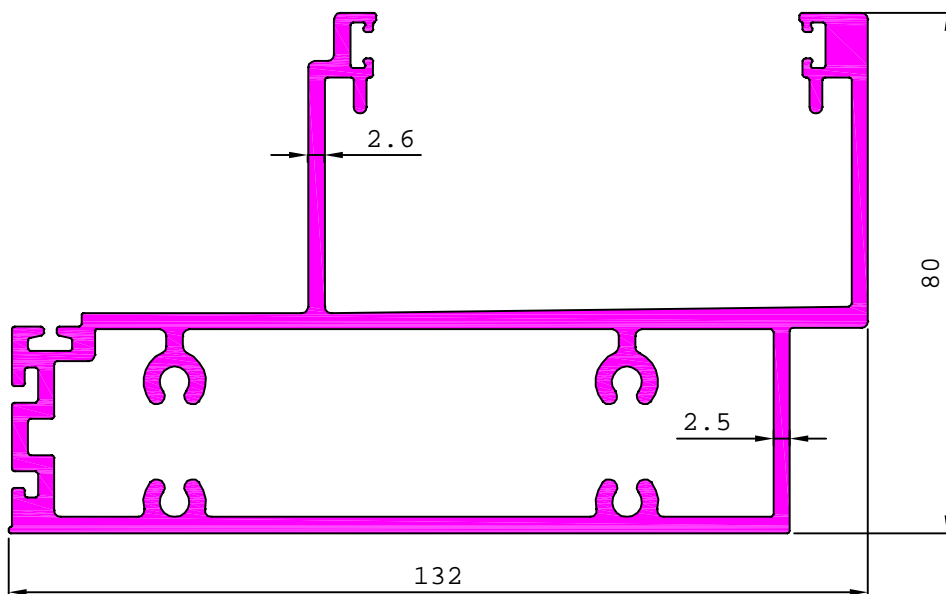

MATCHING WITH G102017

## CURTAIN WALL SECTION

G101887

0.230 kg/m

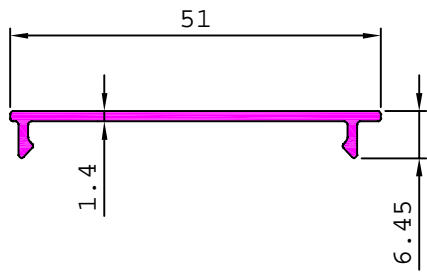

MATCHING WITH G101886

G102017

1.242 kg/m

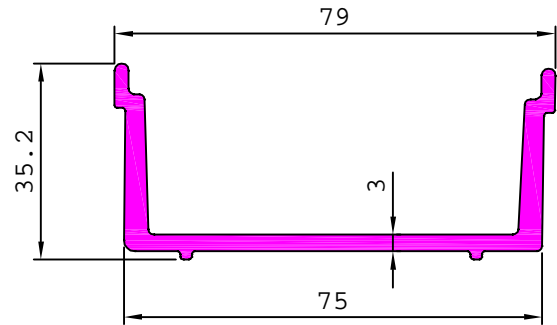

MATCHING WITH G102014

G102043

2.172 kg/m

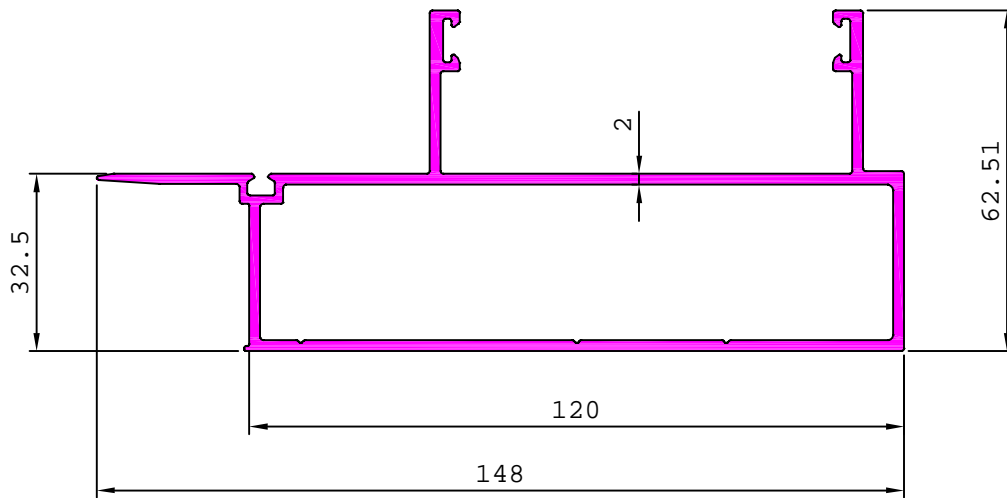

MATCHING WITH G102044

G102069

5.213 kg/m

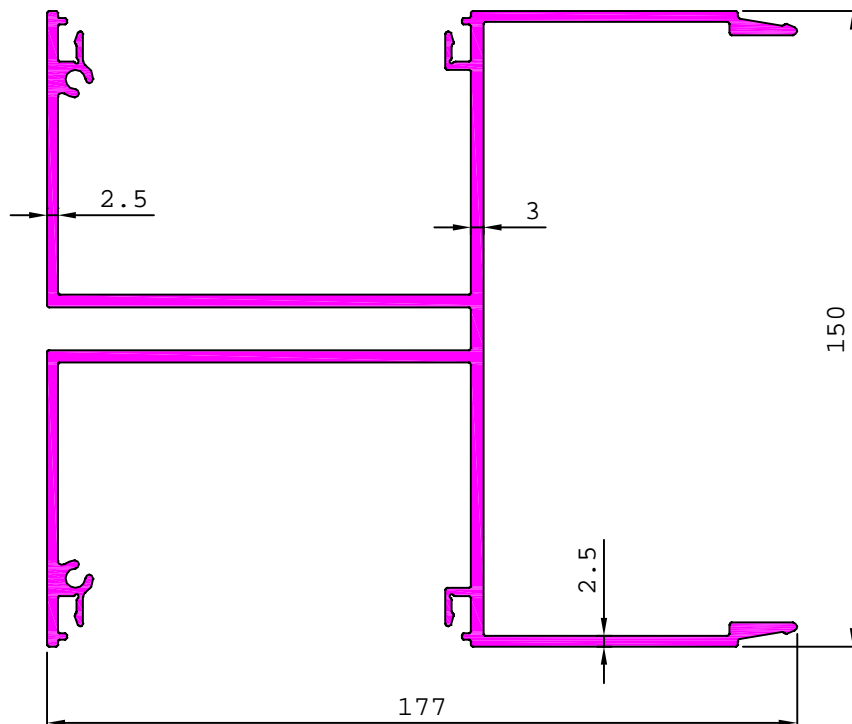

MATCHING WITH G102070,G102071

# CURTAIN WALL SECTION

G102016

2.077 kg/m

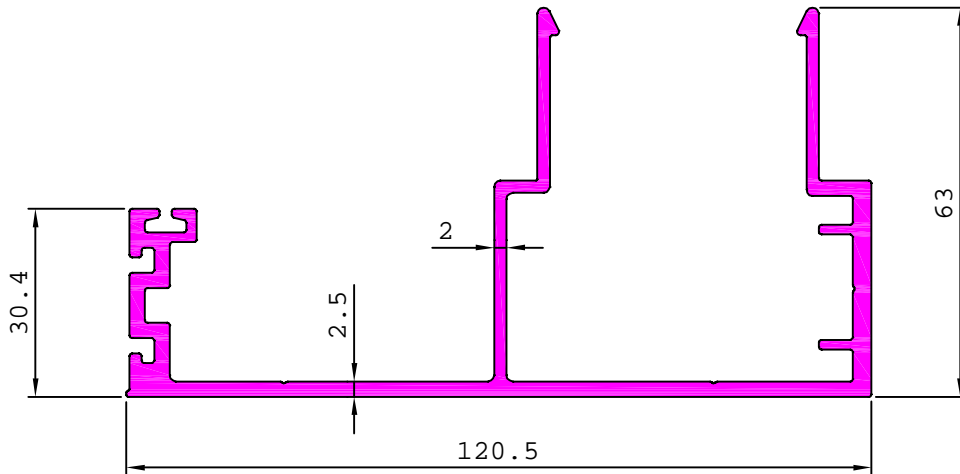

MATCHING WITH G102015

G102044

2.036 kg/m

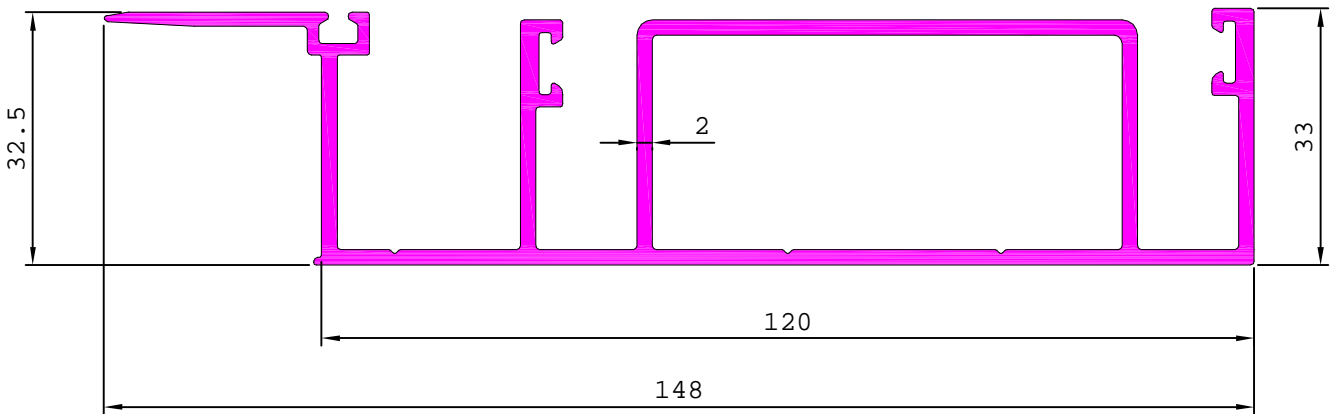

MATCHING WITH G102043

G102062

0.466 kg/m

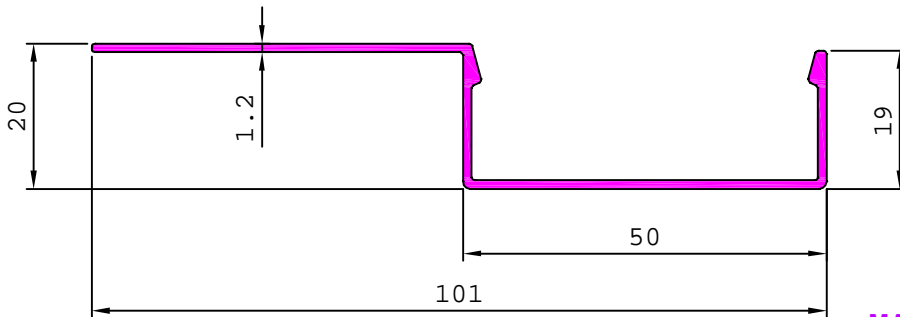

MATCHING WITH 36003

G102045

2.100 kg/m

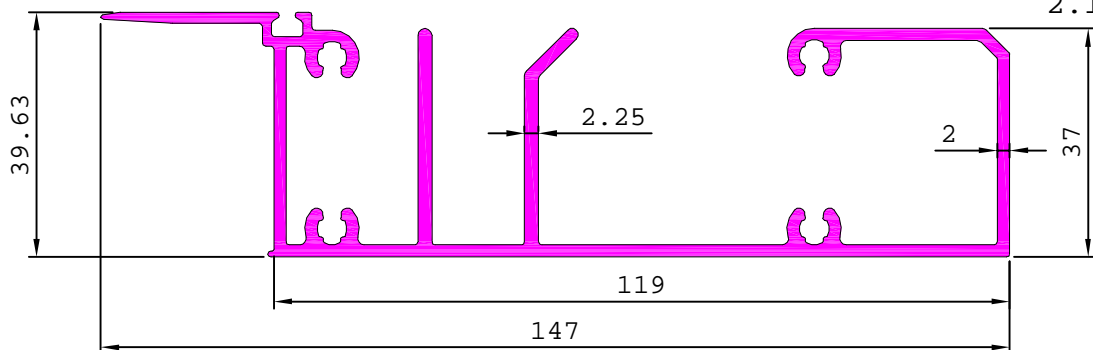

MATCHING WITH G102046,G102051

## CURTAIN WALL SECTION

G102018

2.374 kg/m

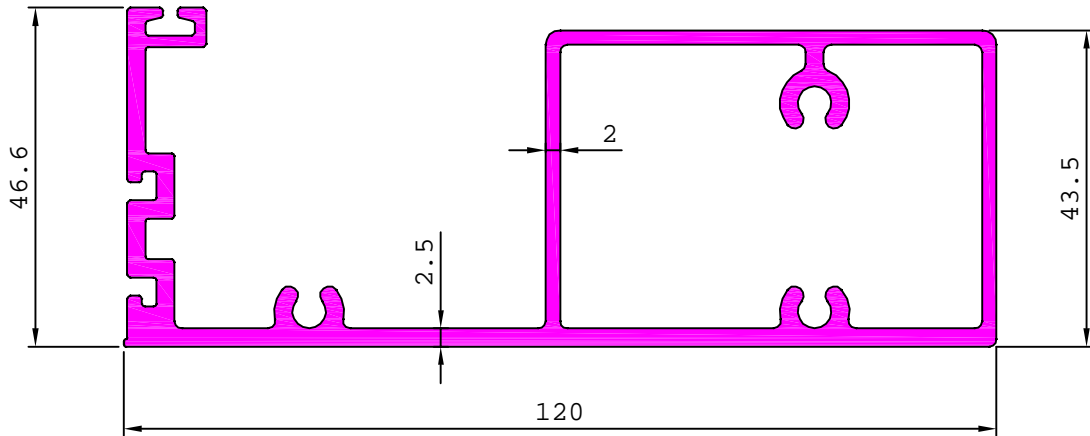

G101980

2.800 kg/m

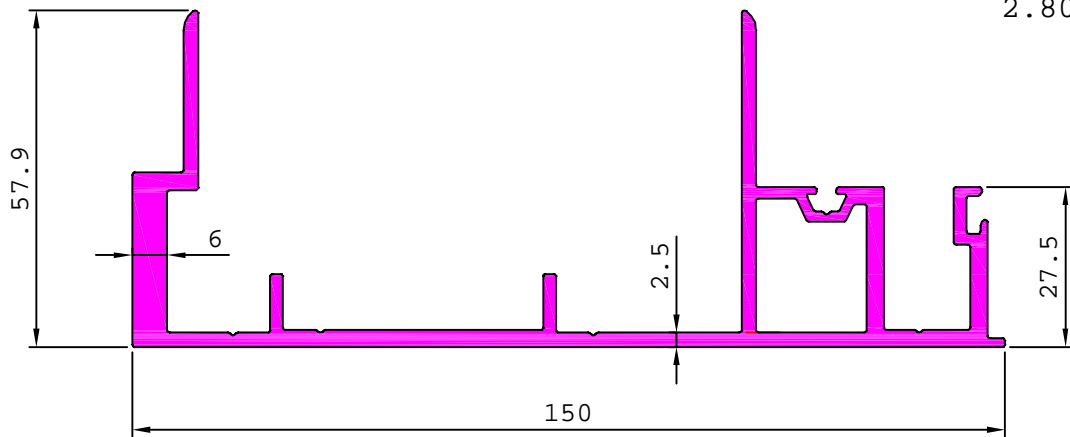

G102015

1.754 kg/m

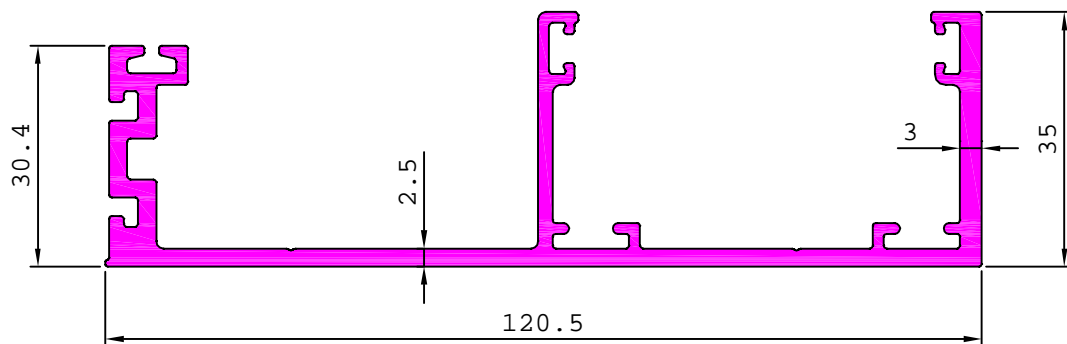

MATCHING WITH G102016

G101979

2.341 kg/m

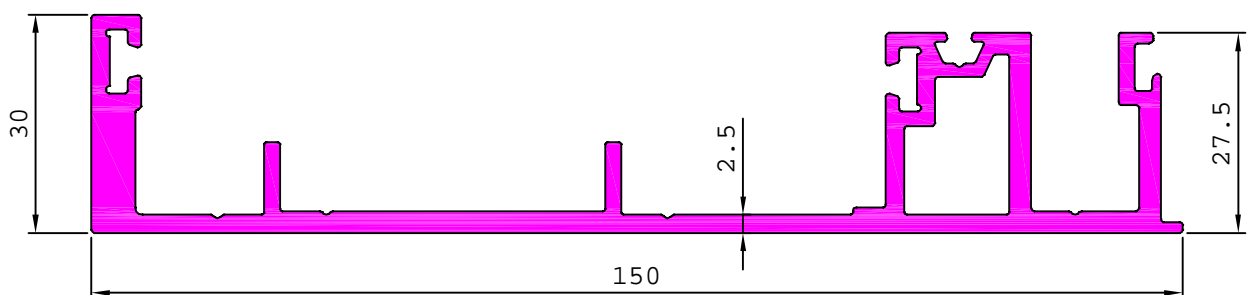

# CURTAIN WALL SECTION

G102048

2.914 kg/m

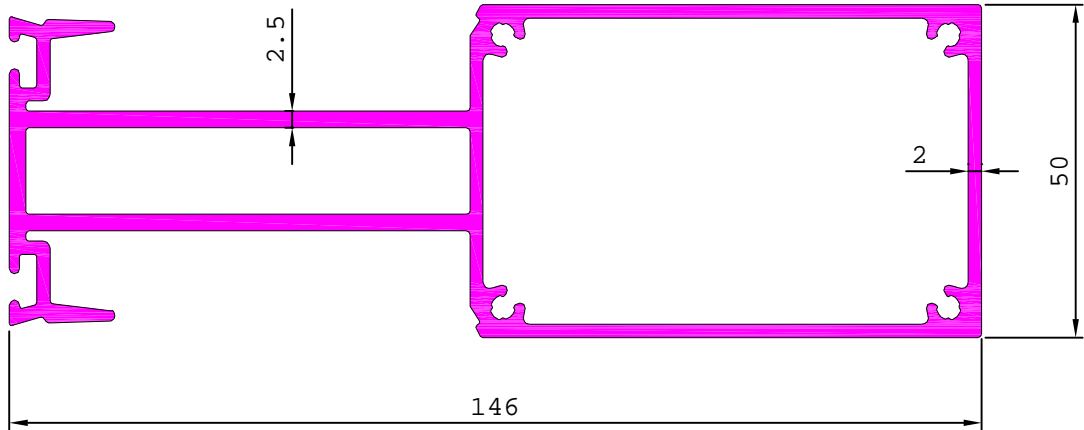

MATCHING WITH G102049

G102072

3.983 kg/m

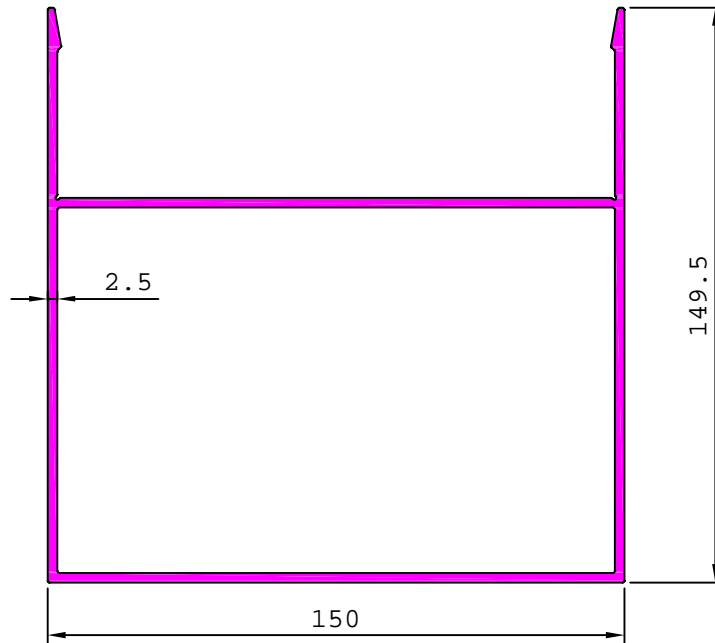

MATCHING WITH G102070

G102070

3.071 kg/m

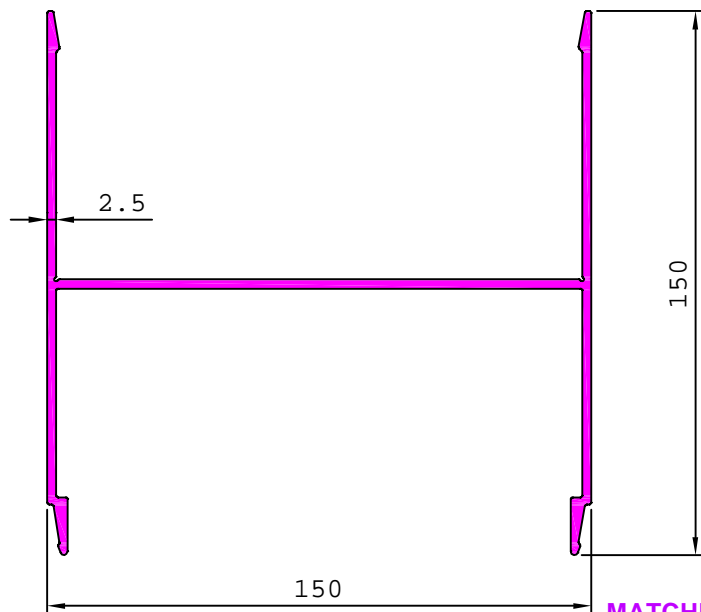

MATCHING WITH G102069,G102072

# CURTAIN WALL SECTION

G102046

2.959 kg/m

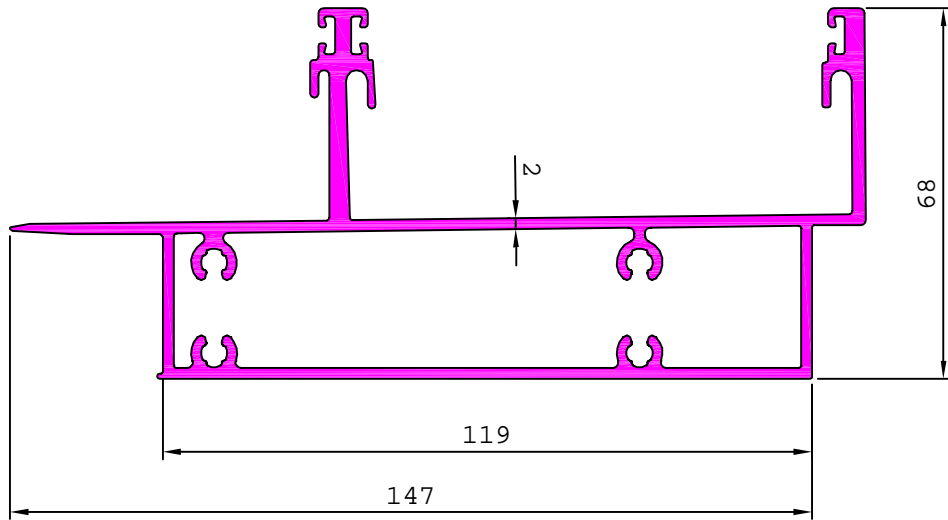

MATCHING WITH G102045,G102051

G102047

2.650 kg/m

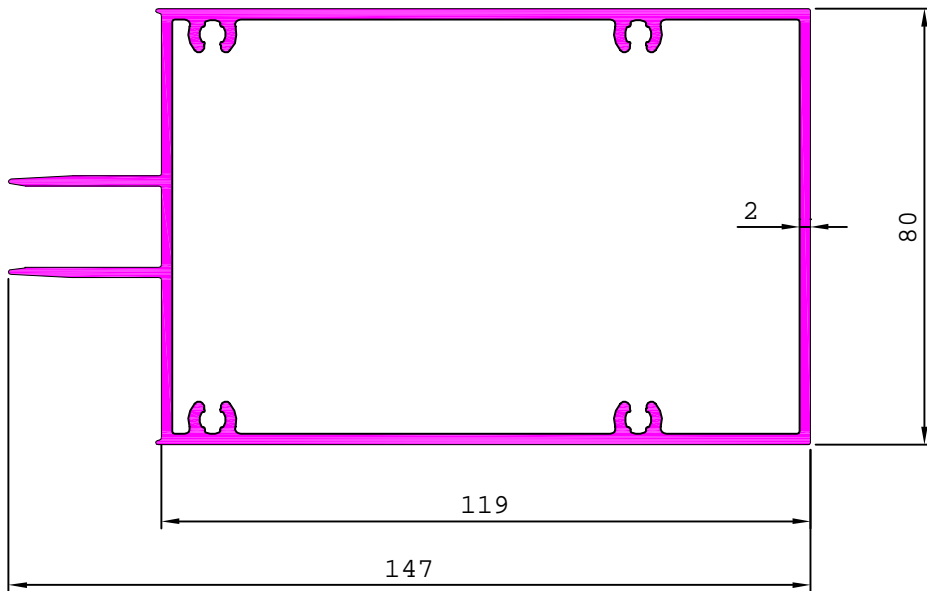

G101969

5.200 kg/m

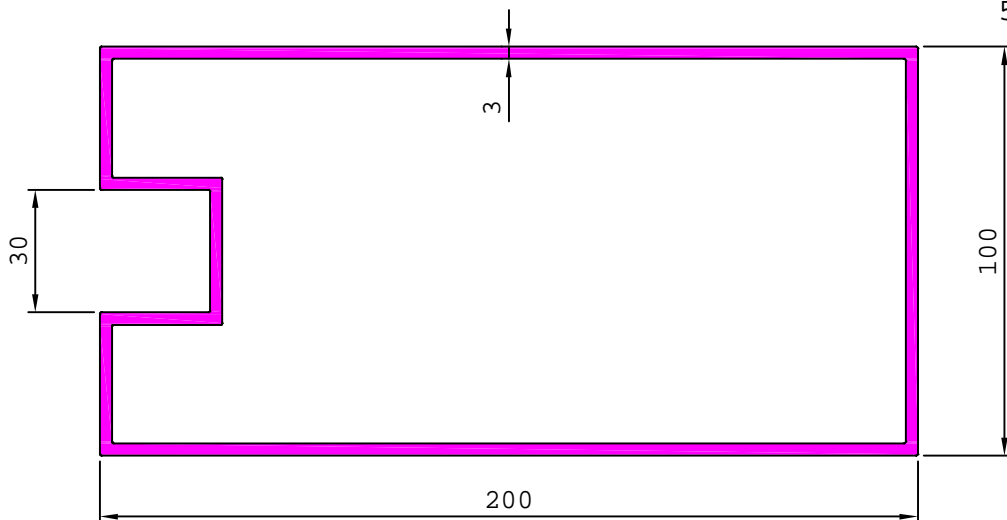

## CURTAIN WALL SECTION

G102054

1.948 kg/m

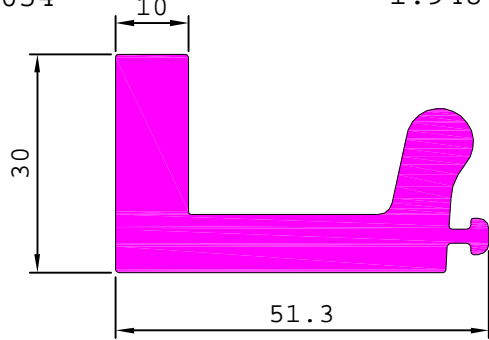

MATCHING WITH G102053

G102053

2.405 kg/m

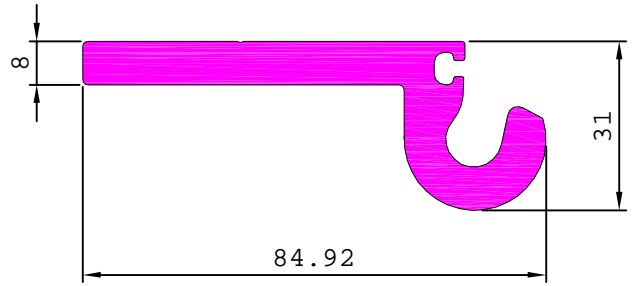

MATCHING WITH G102054

G102020

0.299 kg/m

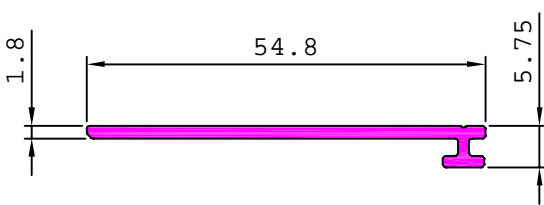

G102019

0.340 kg/m

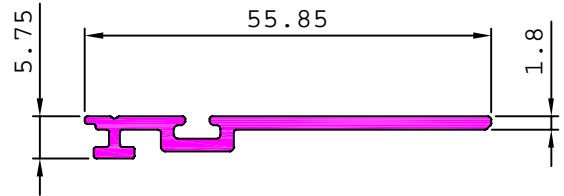

G101951

1.635 kg/m

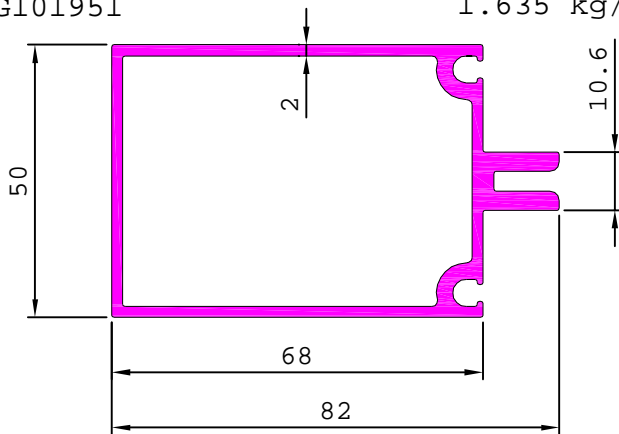

G102051

0.941 kg/m

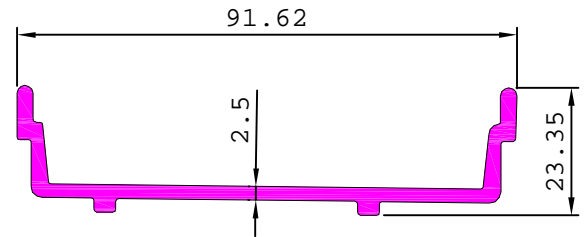

MATCHING WITH G102014

G102071

0.458 kg/m

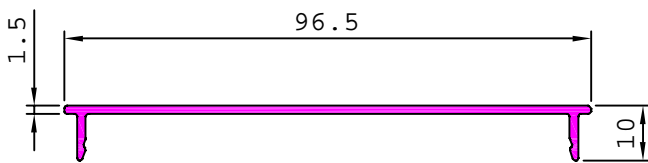

MATCHING WITH G102069

G102049

0.407 kg/m

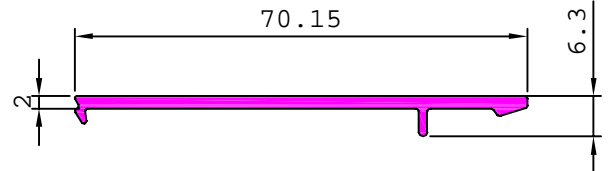

MATCHING WITH G102048

G102201

0.226 kg/m

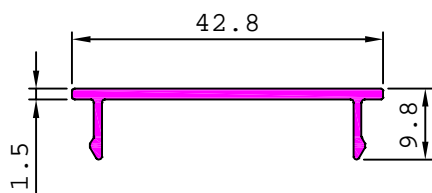

MATCHING WITH G102202

G102205

0.802 kg/m

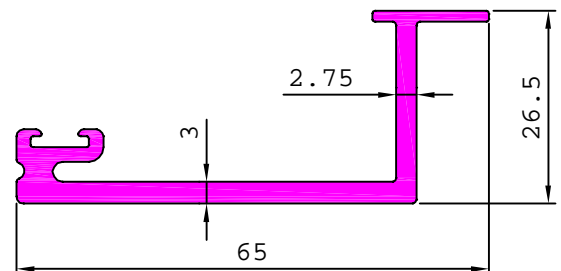

## CURTAIN WALL SECTION

G102013

3.409 kg/m

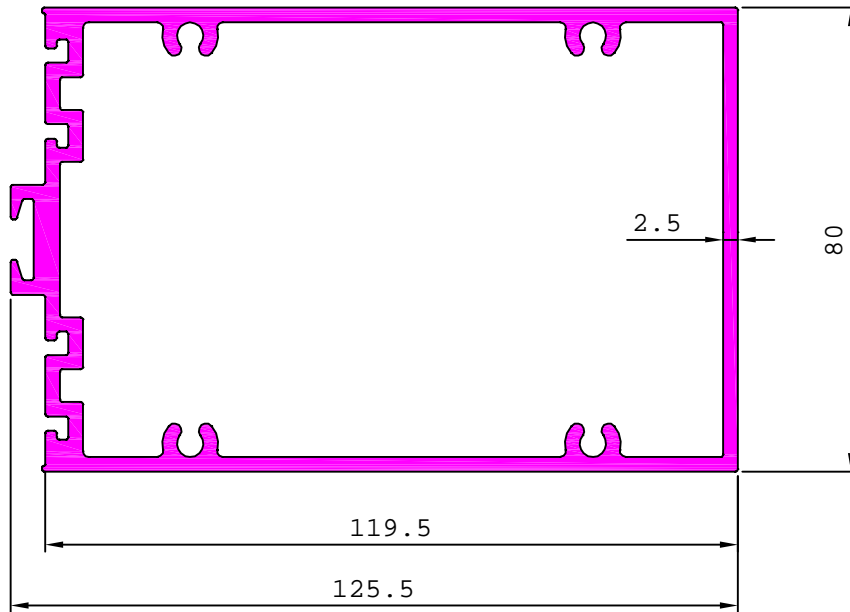

G102050

0.273 kg/m

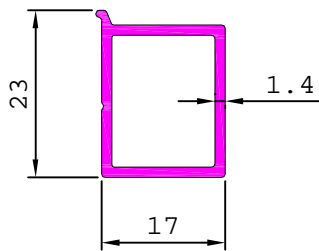

G102021

0.566 kg/m

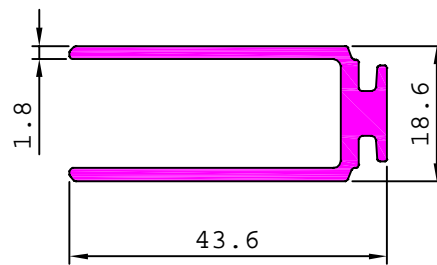

G102052

0.243 kg/m

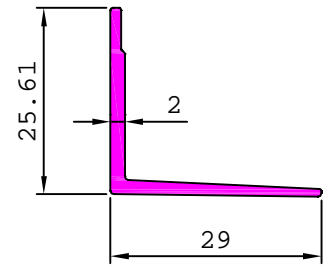

G102193

2.085 kg/m

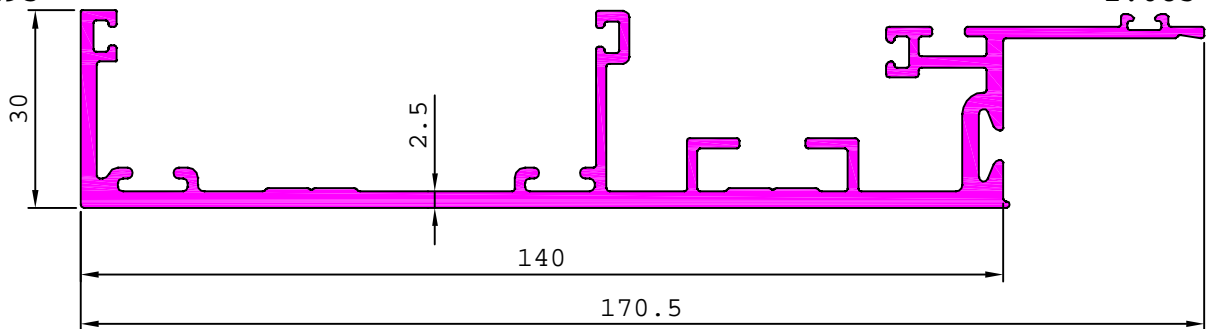

MATCHING WITH G102192

G102202

1.952 kg/m

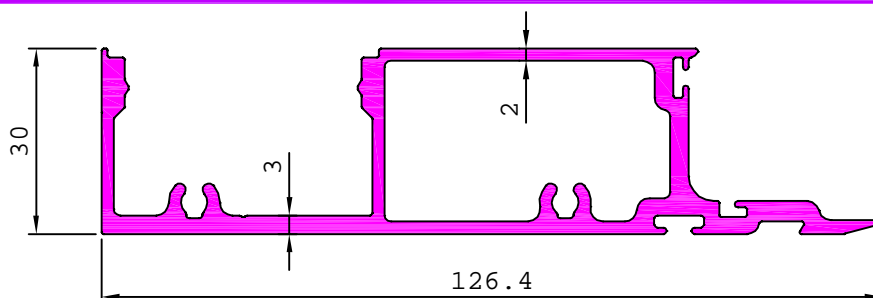

MATCHING WITH G102201

## CURTAIN WALL SECTION

G102192

2.564 kg/m

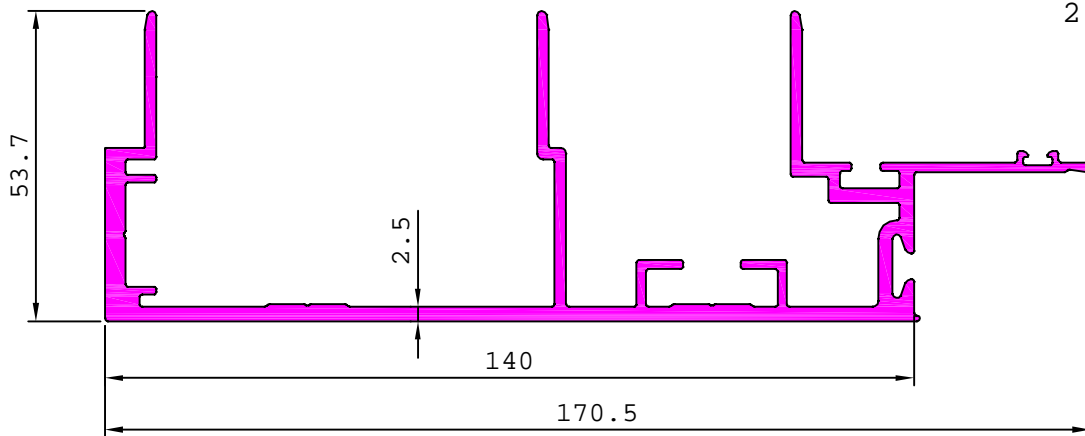

MATCHING WITH G102193

G102194

3.706 kg/m

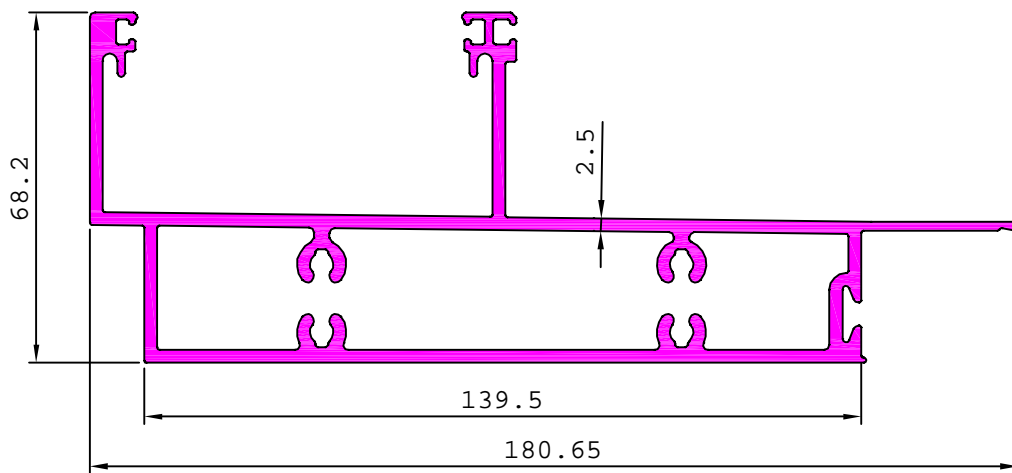

MATCHING WITH G102195

G102195

3.224 kg/m

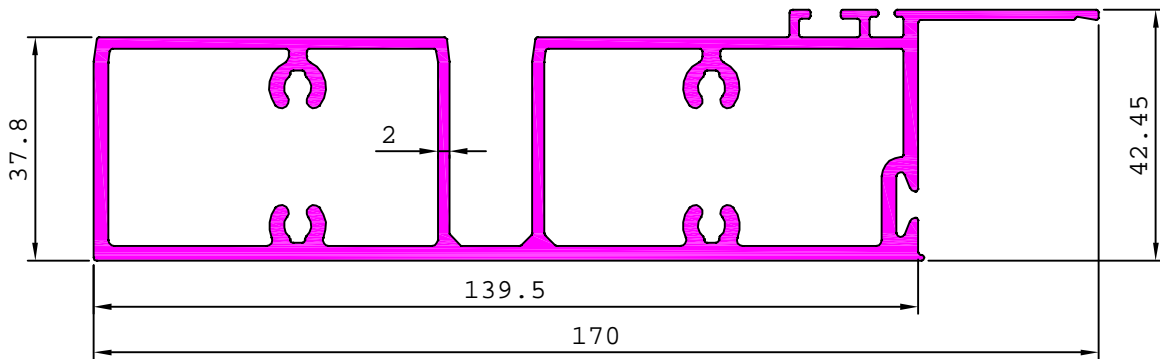

MATCHING WITH G102194

G102207

2.770 kg/m

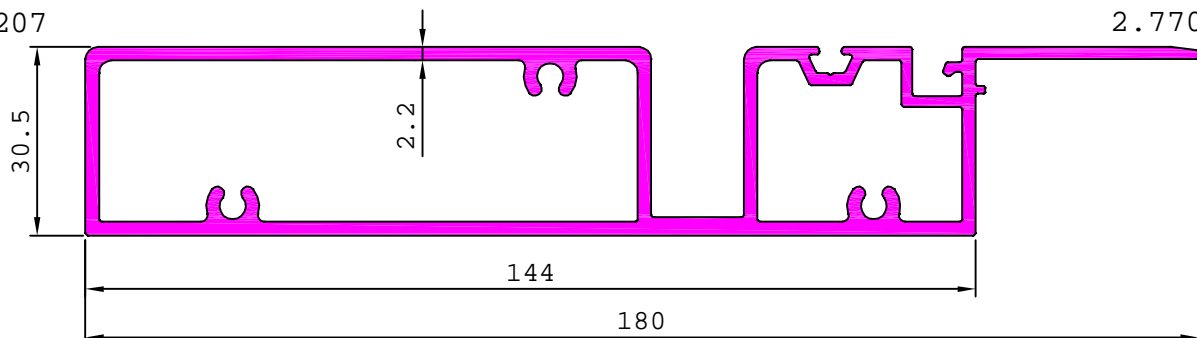

## CURTAIN WALL SECTION

G102206

1.542 kg/m

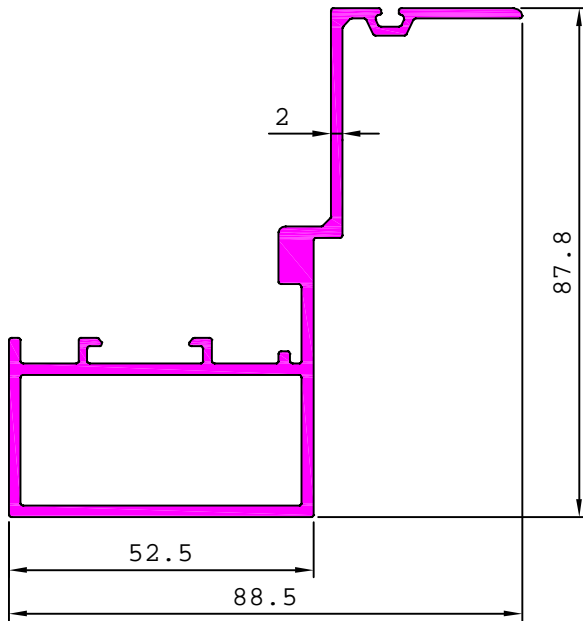

G102654

1.561 kg/m

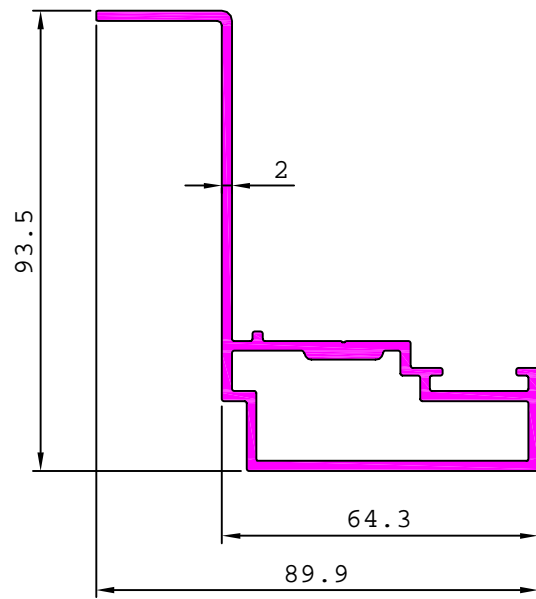

G102204

1.815 kg/m

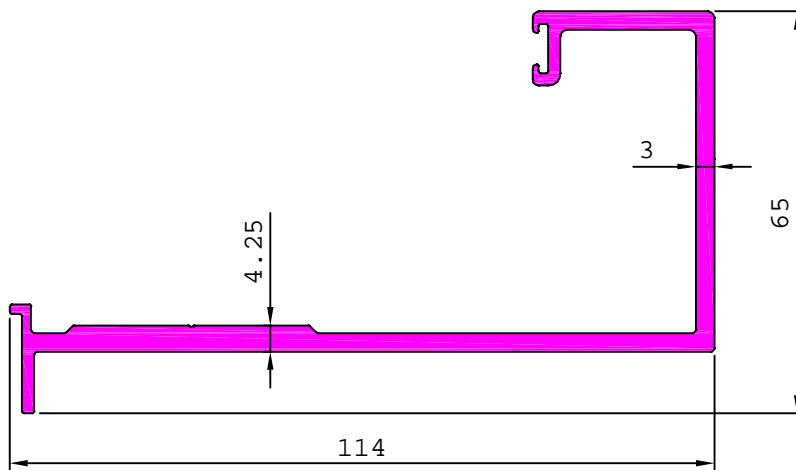

G102208

3.249 kg/m

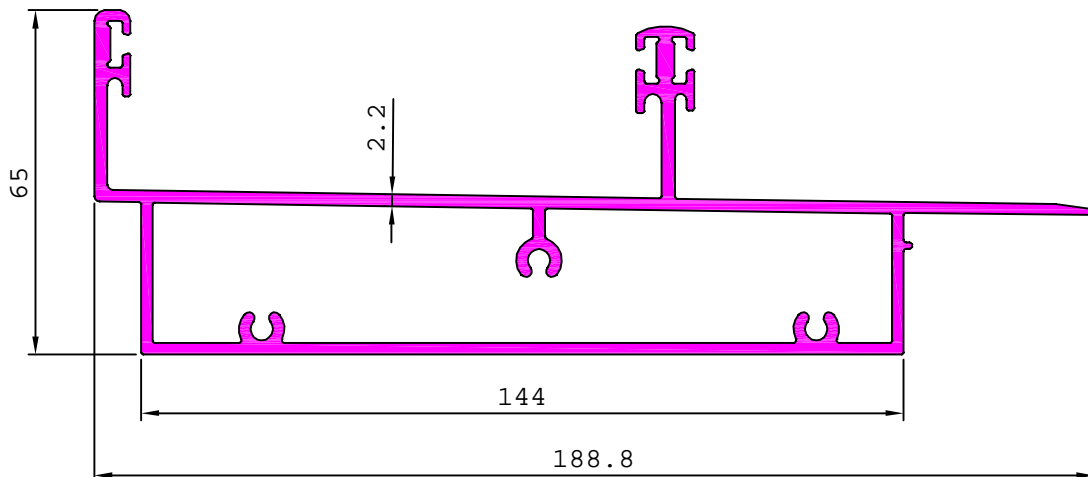

## CURTAIN WALL SECTION

G102196

3.633 kg/m

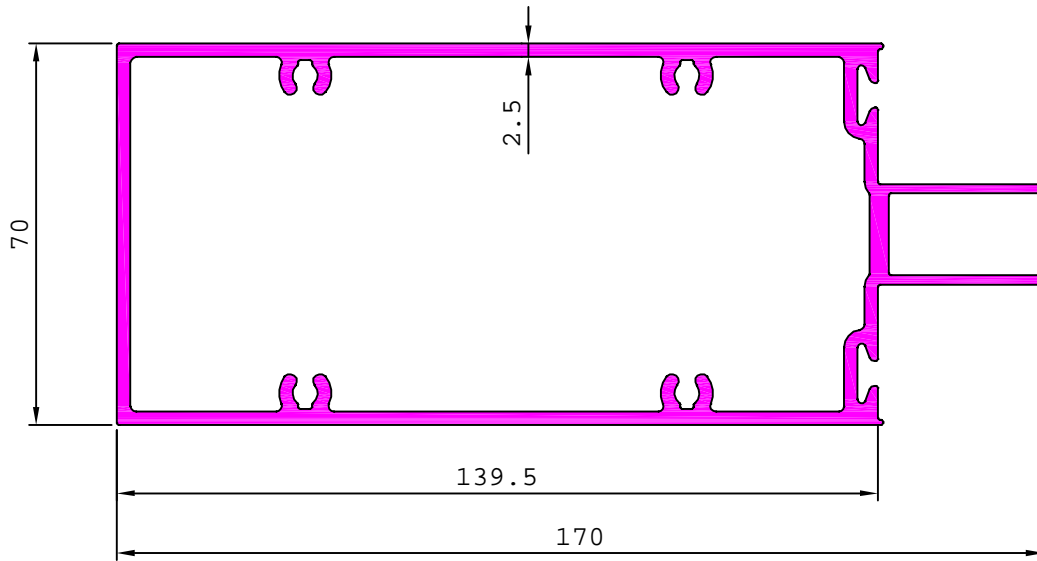

G102209

3.244 kg/m

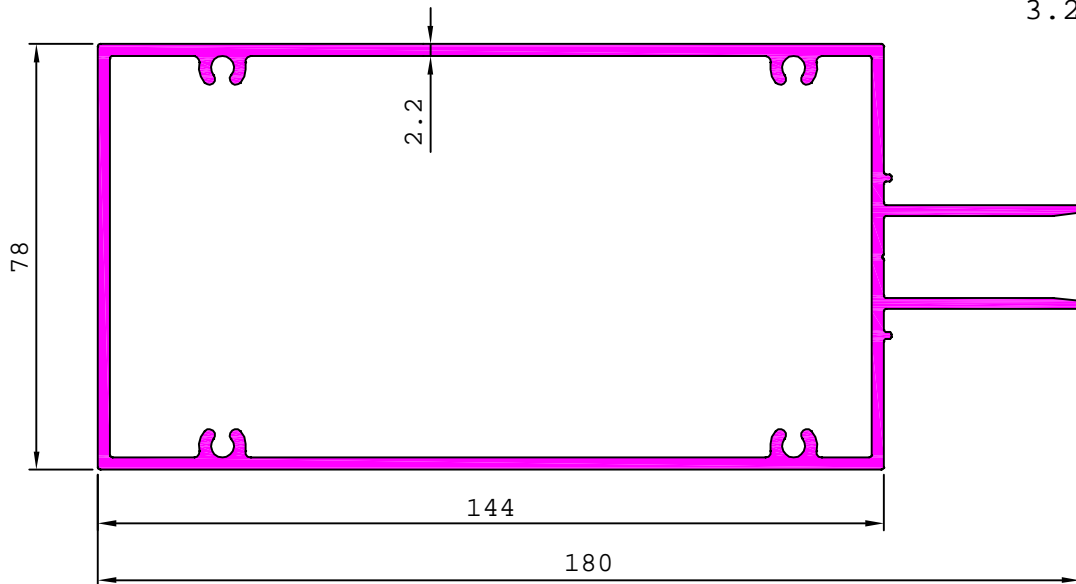

G102244

4.646 kg/m

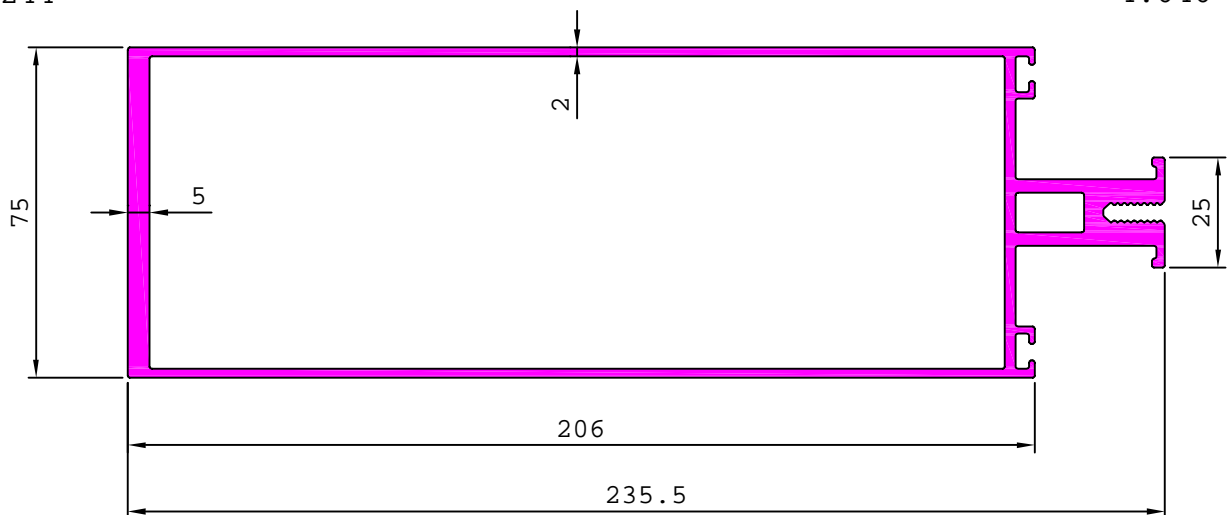

## CURTAIN WALL SECTION

G102245

0.982 kg/m

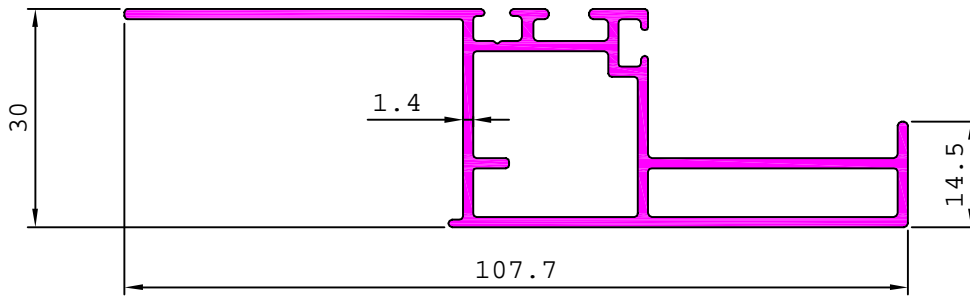

G102210

2.503 kg/m

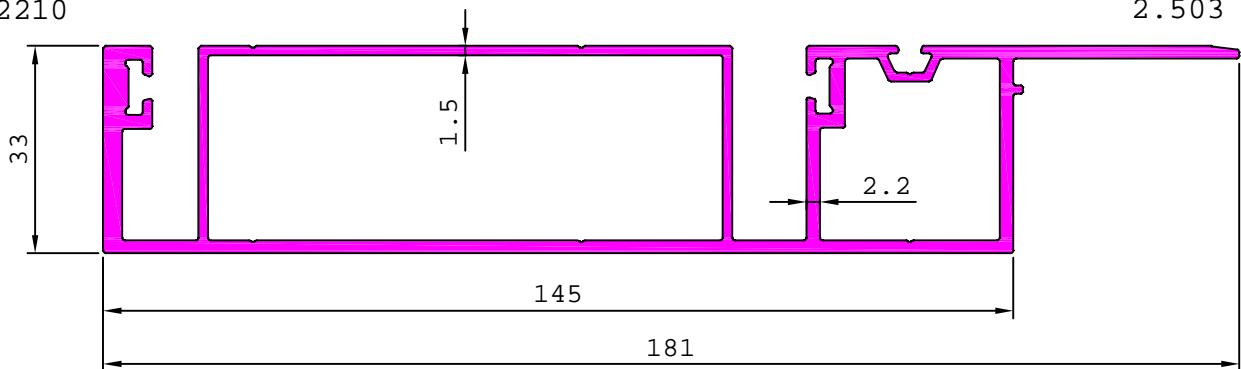

G102211

2.739 kg/m

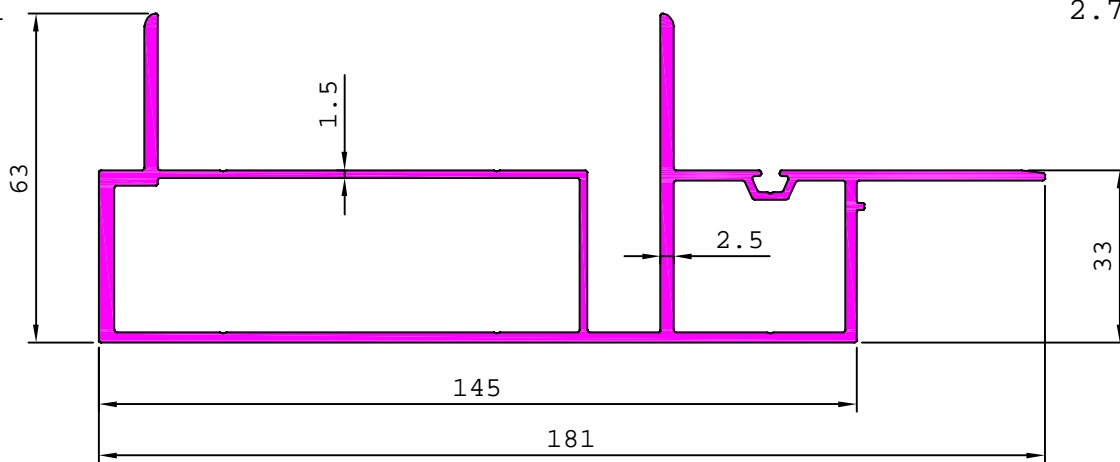

G102203

2.667 kg/m

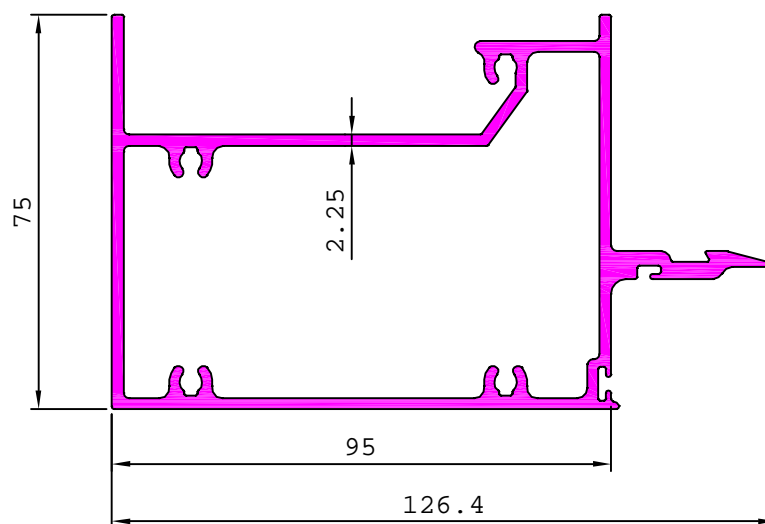

## CURTAIN WALL SECTION

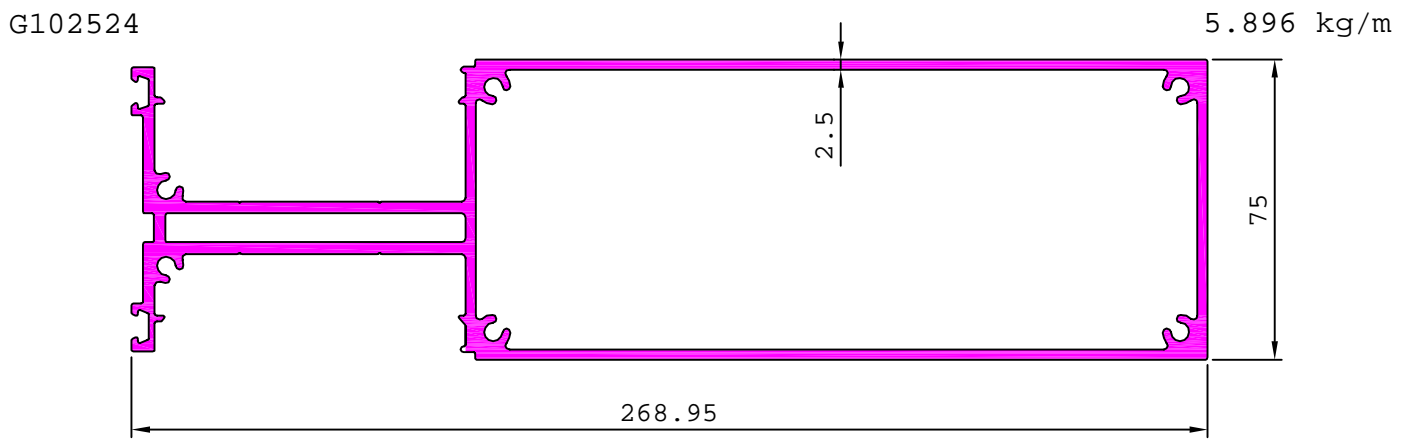
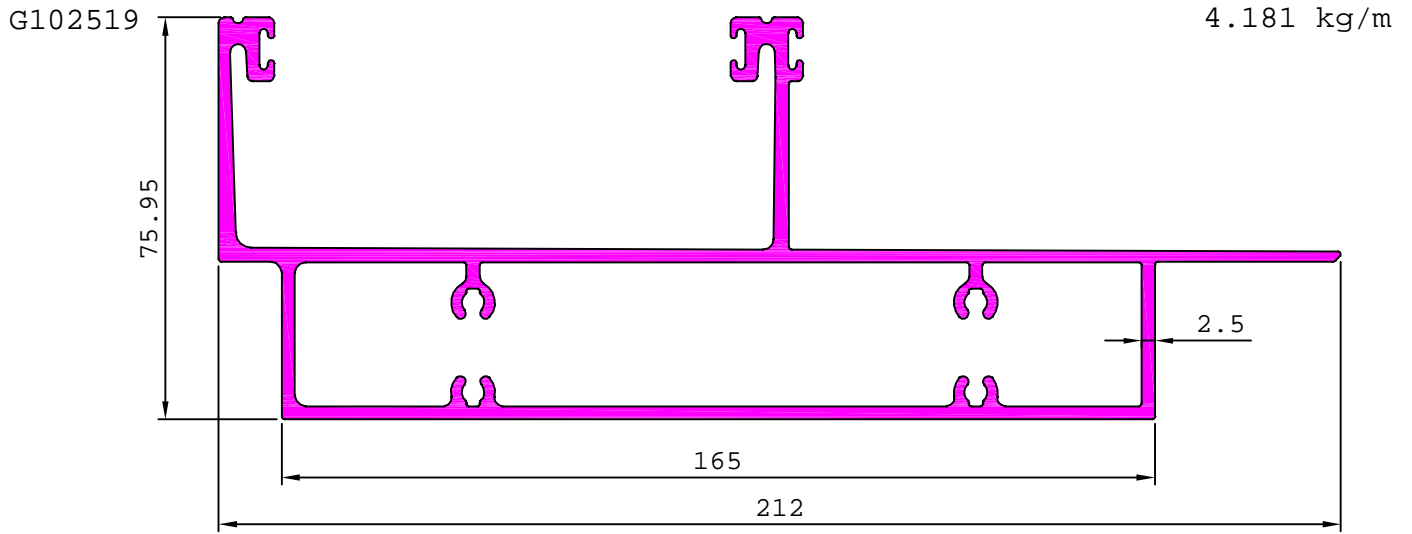

MATCHING WITH G102525

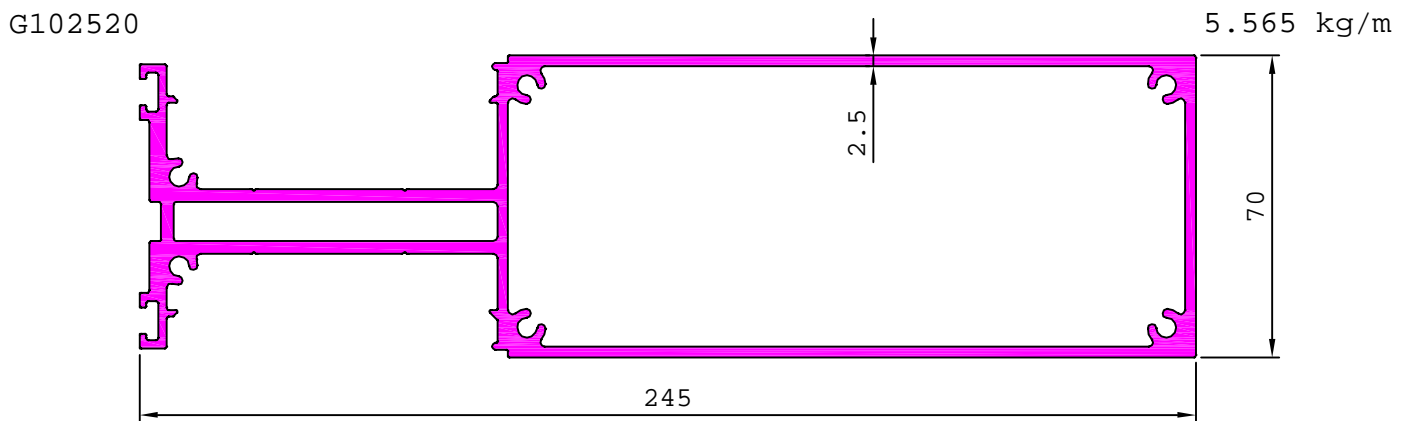

MATCHING WITH G102521

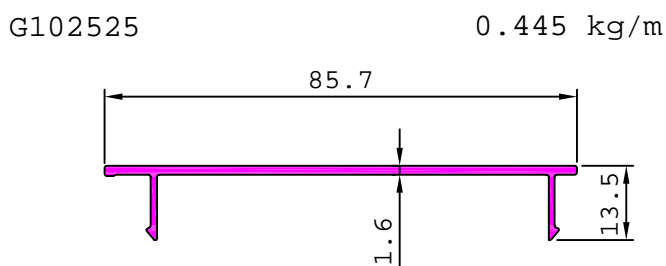

MATCHING WITH G102524

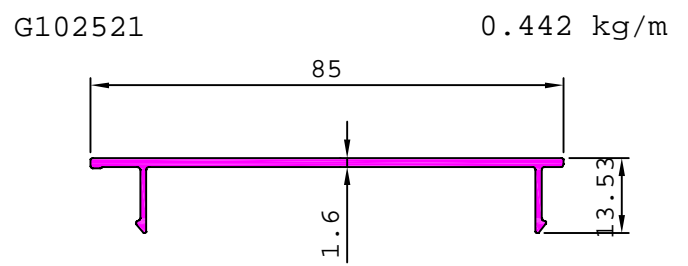

MATCHING WITH G102520

## CURTAIN WALL SECTION

G102523

3.747 kg/m

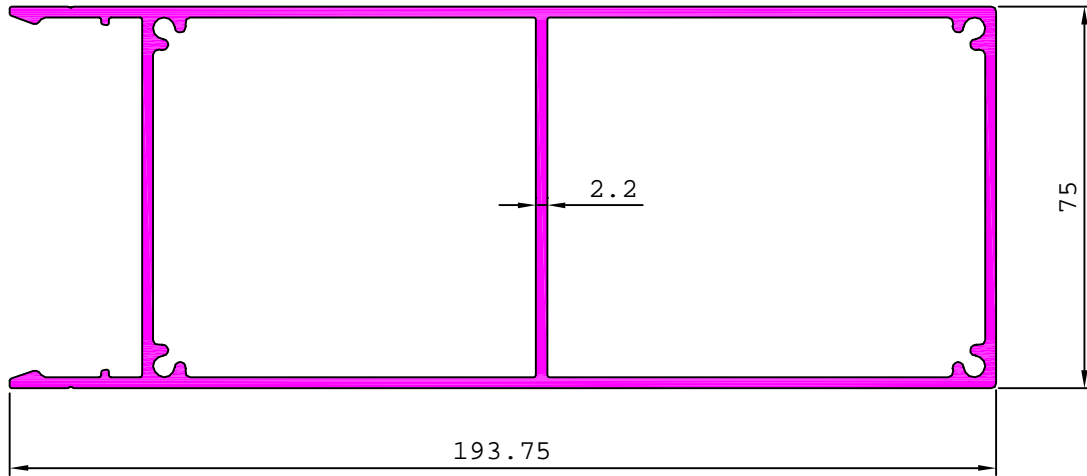

MATCHING WITH G102522

G102495

4.001 kg/m

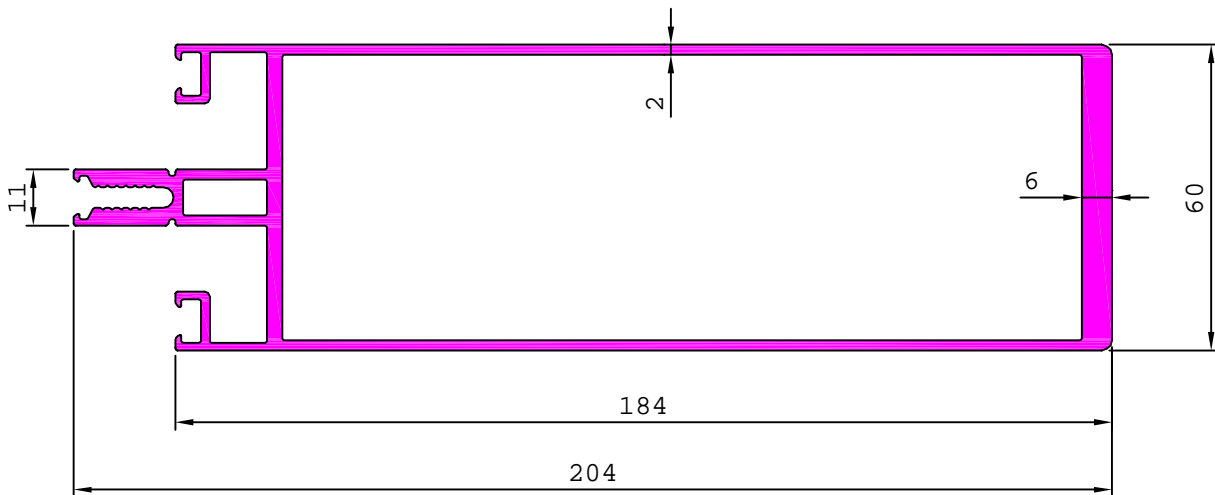

MATCHING WITH G102522

G102517

3.835 kg/m

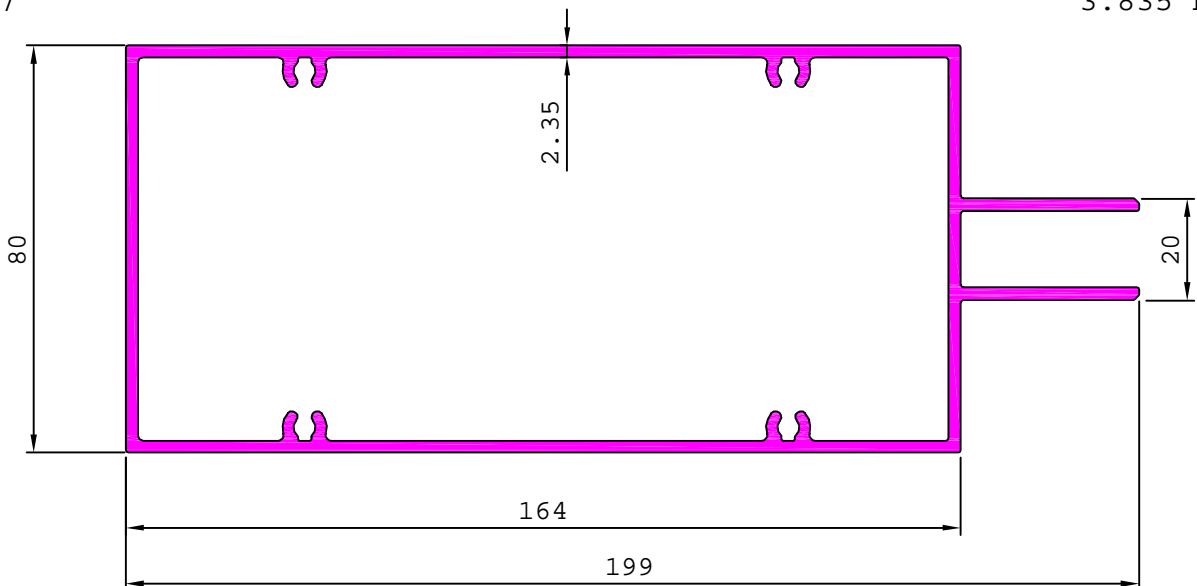

## CURTAIN WALL SECTION

G102515

2.895 kg/m

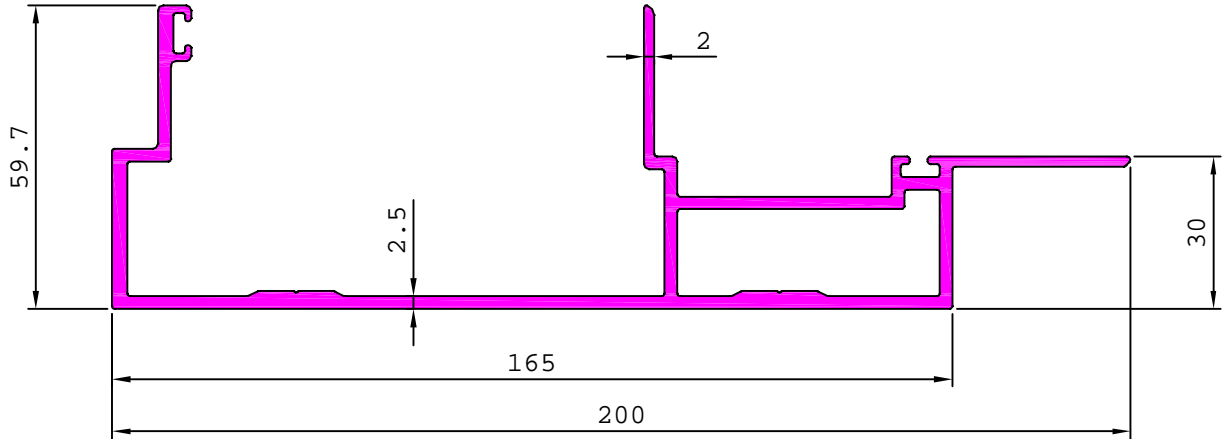

MATCHING WITH G102516

G102516

2.715 kg/m

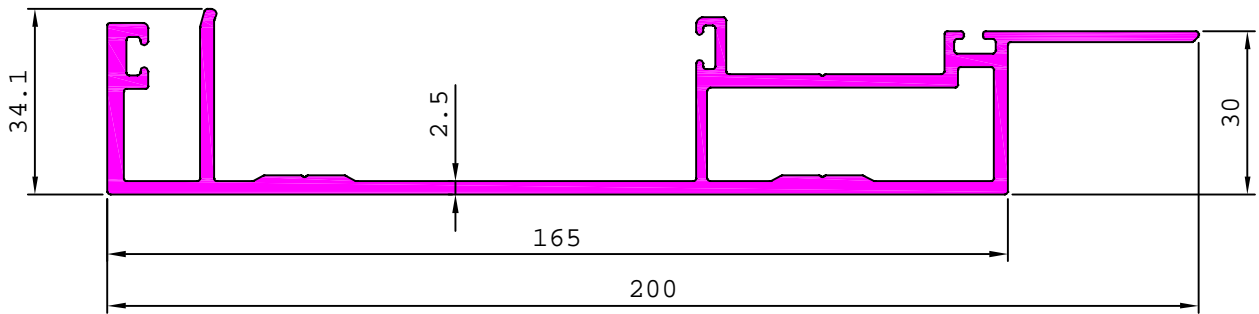

MATCHING WITH G102515

G102518

3.170 kg/m

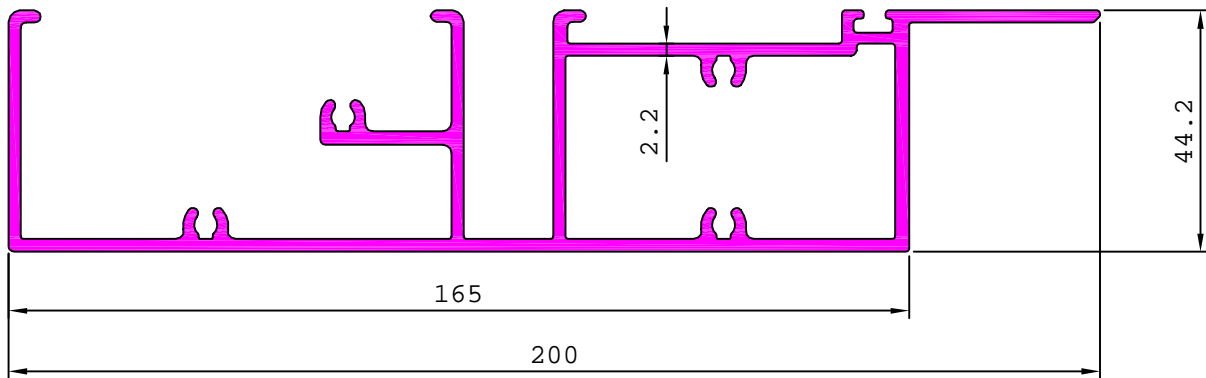

G102460

3.889 kg/m

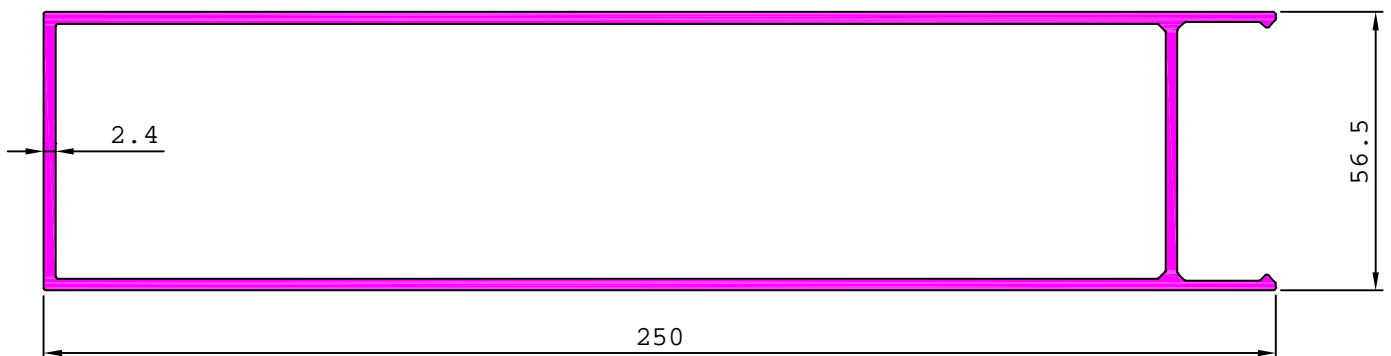

MATCHING WITH S6698

## CURTAIN WALL SECTION

G102522

0.741 kg/m

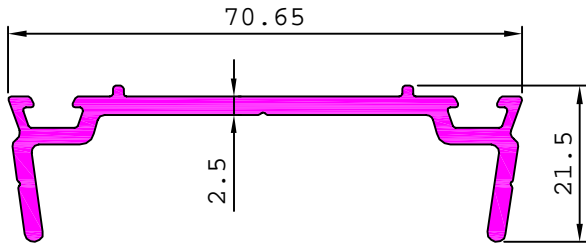

MATCHING WITH G102523

G102631

0.767 kg/m

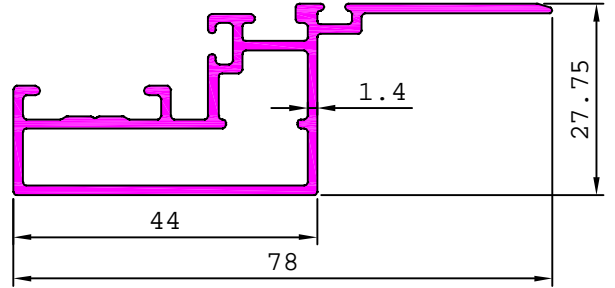

MATCHING WITH 35879

G102645

2.175 kg/m

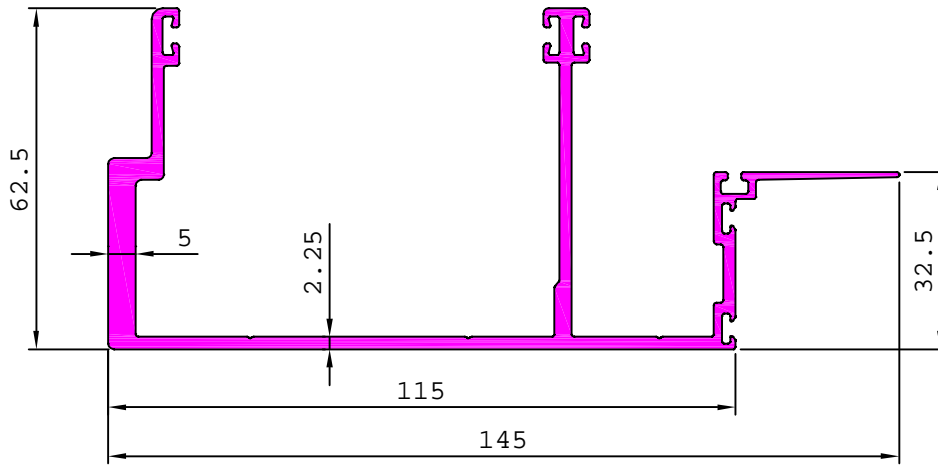

G102643

1.845 kg/m

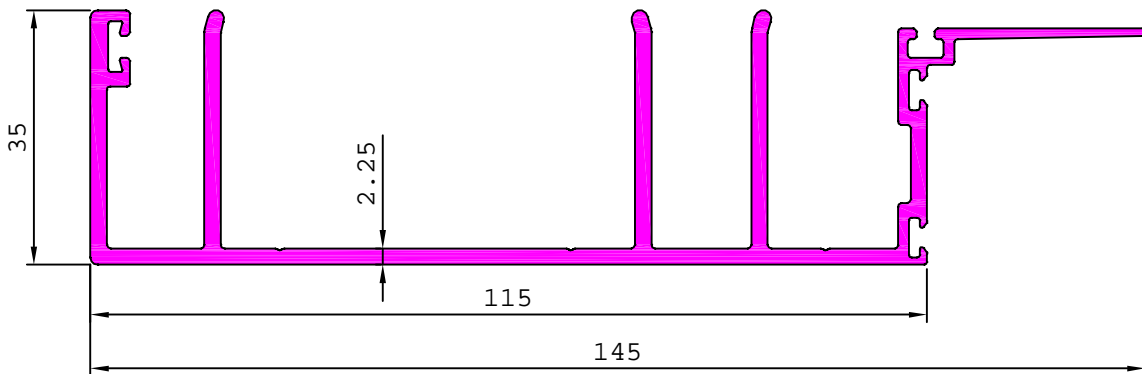

G102646

1.799 kg/m

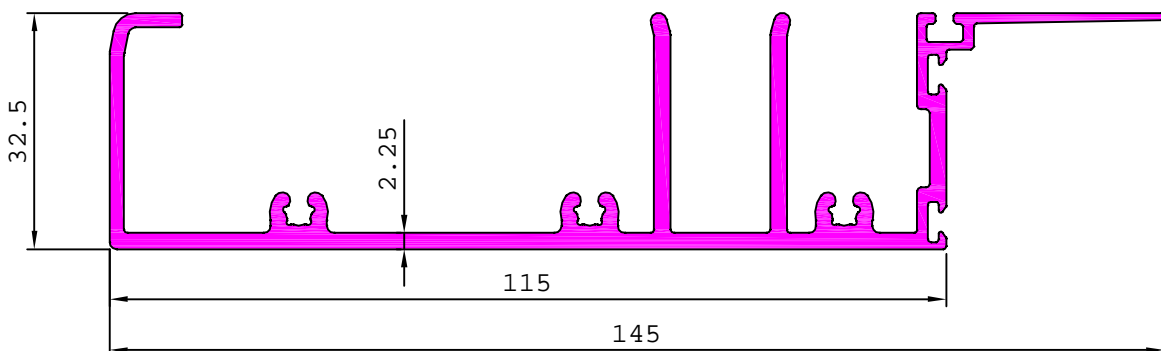

## CURTAIN WALL SECTION

G102650

2.439 kg/m

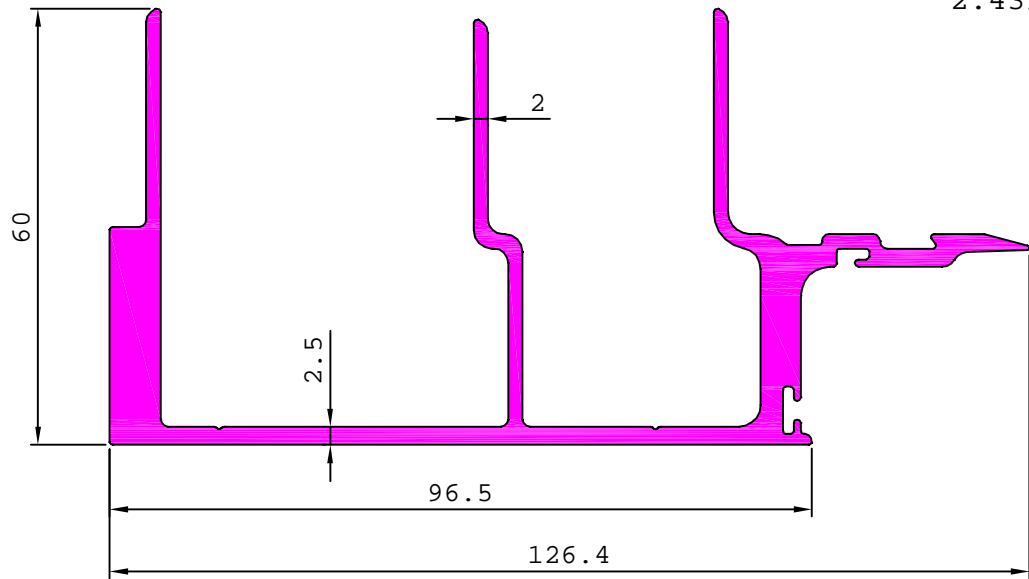

MATCHING WITH G102651,36317

G102651

1.770 kg/m

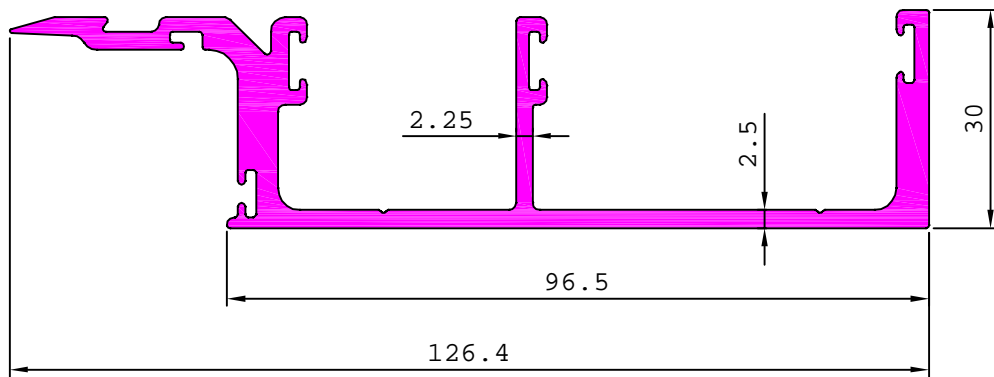

MATCHING WITH G102650,36317

G102948

3.189 kg/m

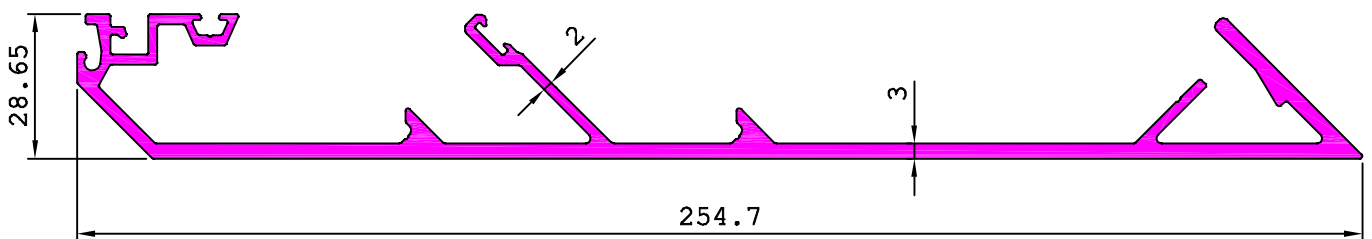

MATCHING WITH G102947,G102949,G102950,G102951

G102951

2.878 kg/m

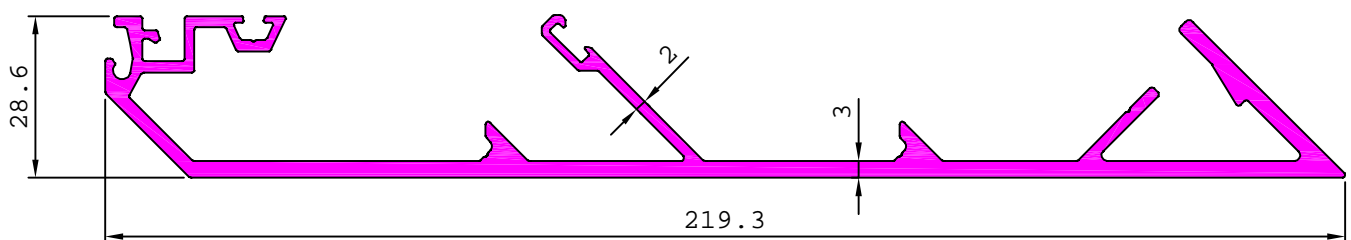

MATCHING WITH G102947,G102948,G102949,G102950

# CURTAIN WALL SECTION

G102873

6.175 kg/m

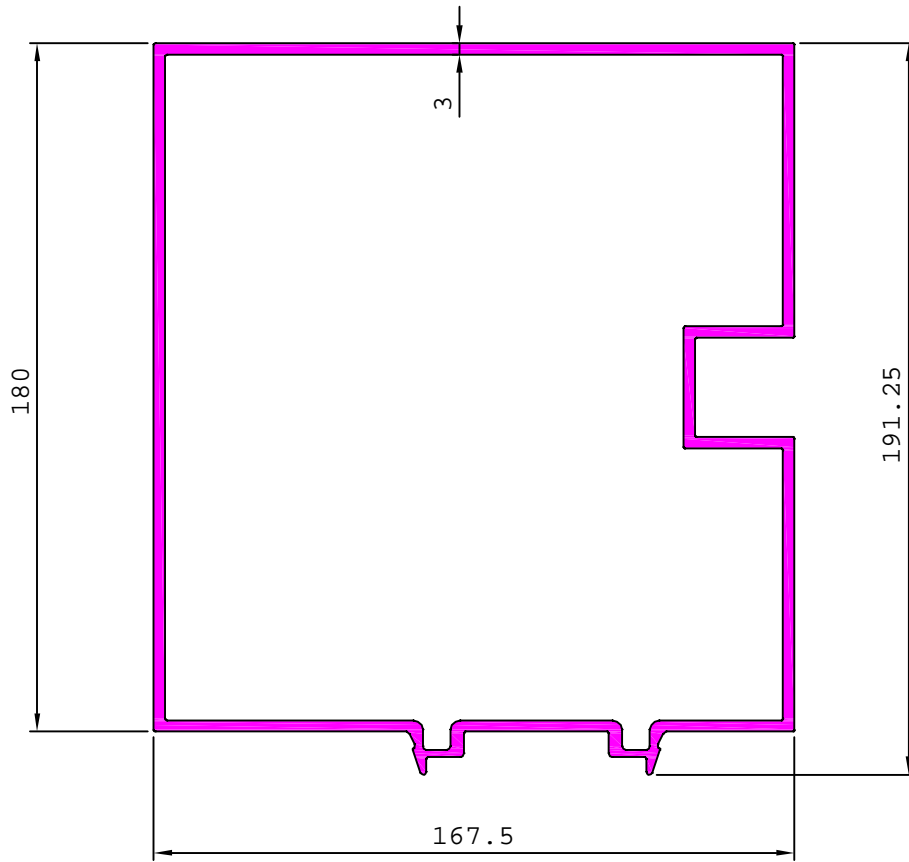

MATCHING WITH 36297

G102874

6.766 kg/m

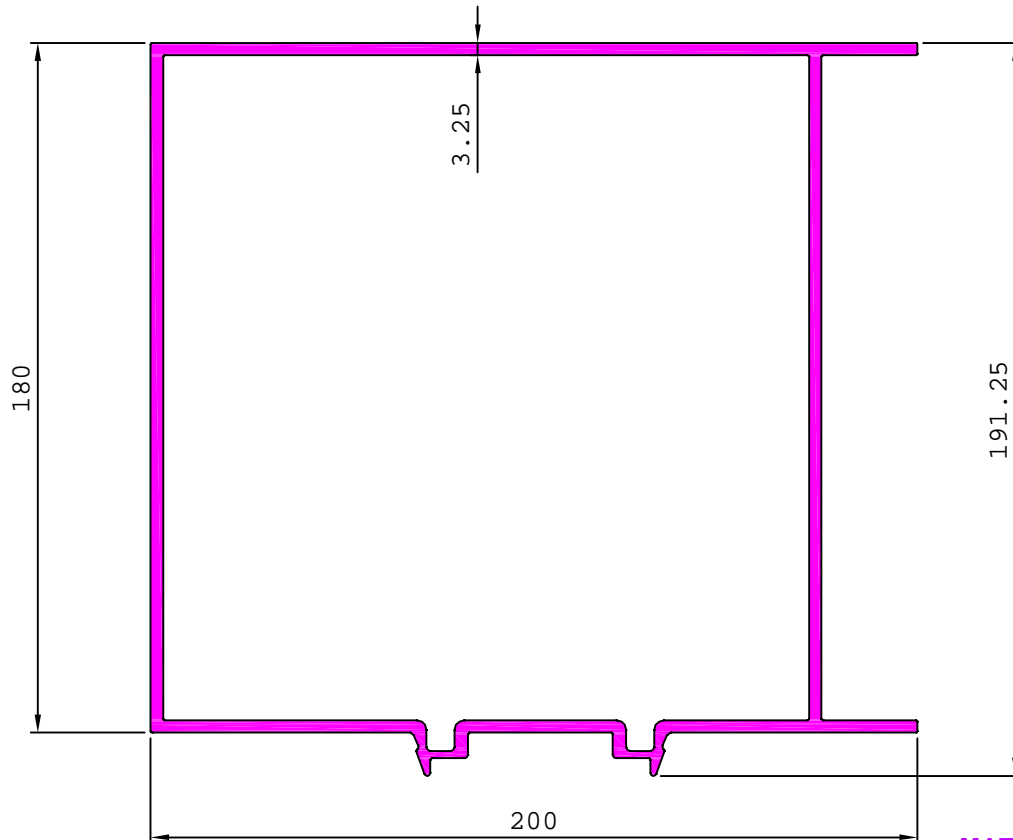

MATCHING WITH 36297

# CURTAIN WALL SECTION

G102973

3.568 kg/m

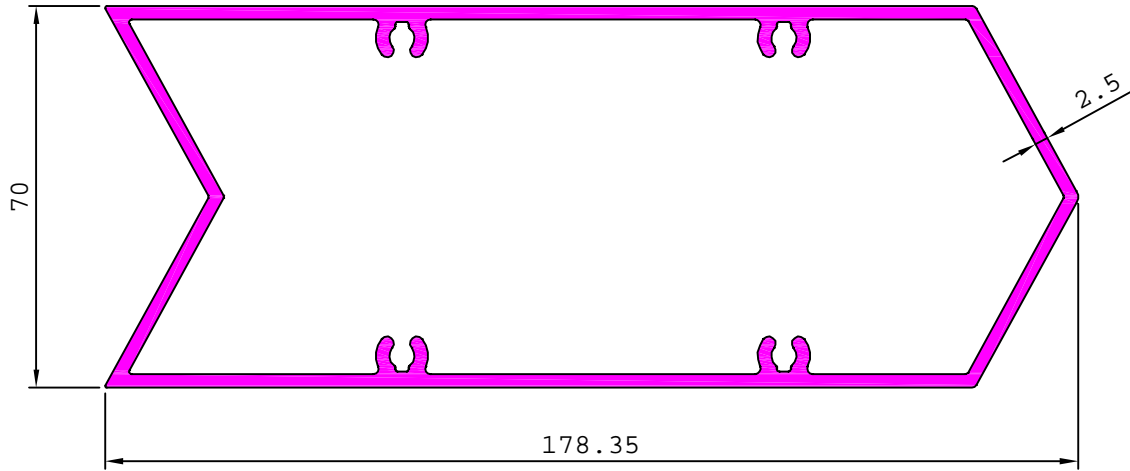

G102980

3.729 kg/m

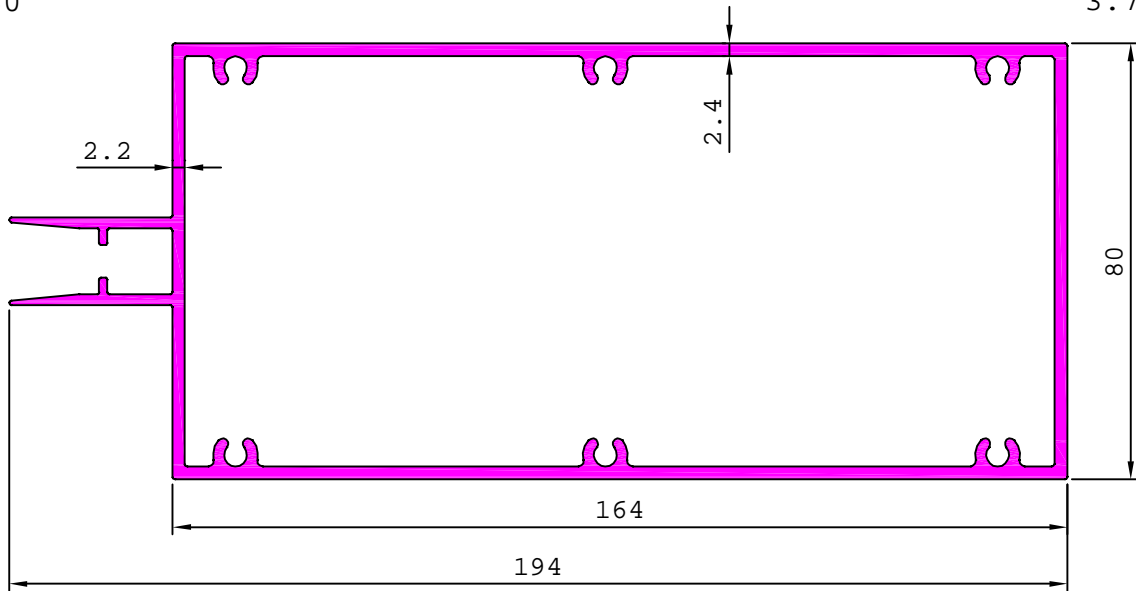

G102971

3.543 kg/m

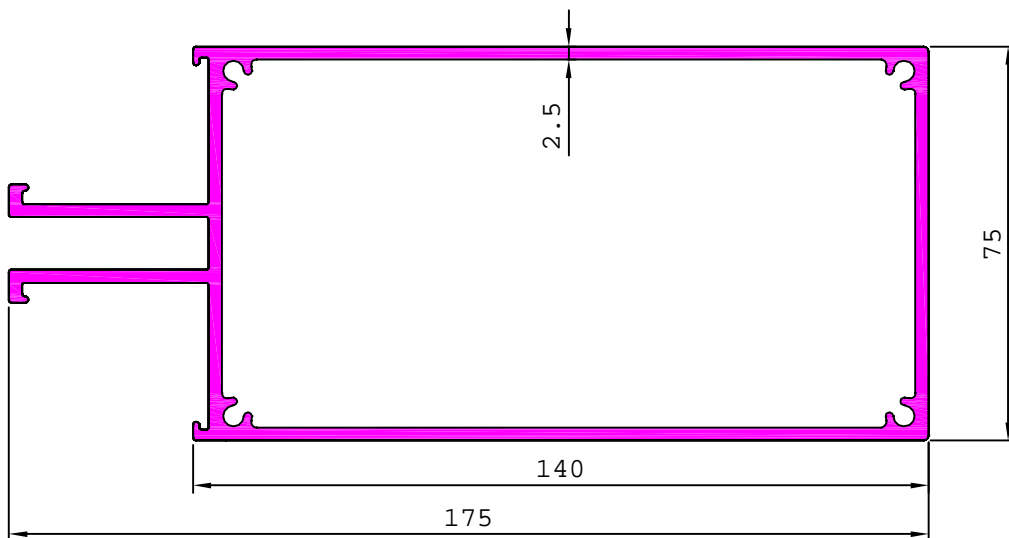

MATCHING WITH G102972

## CURTAIN WALL SECTION

G102977

3.371 kg/m

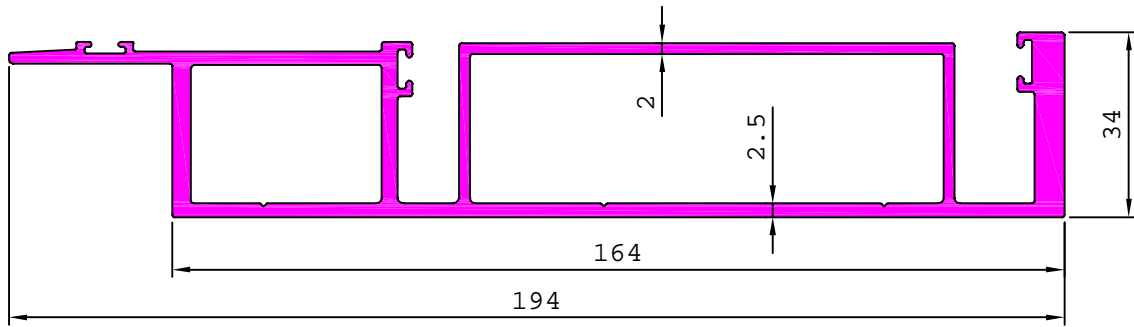

G102976

4.135 kg/m

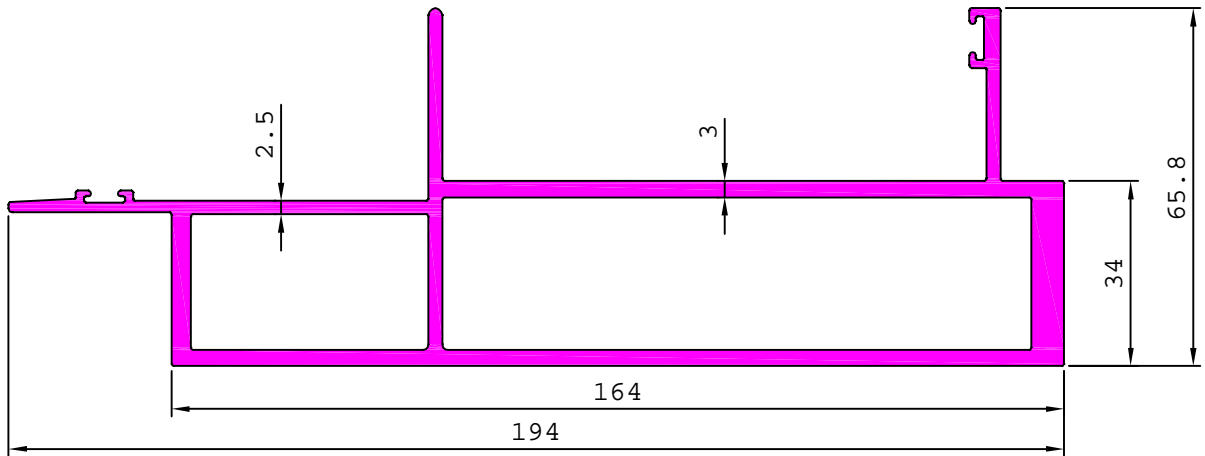

G102978

3.824 kg/m

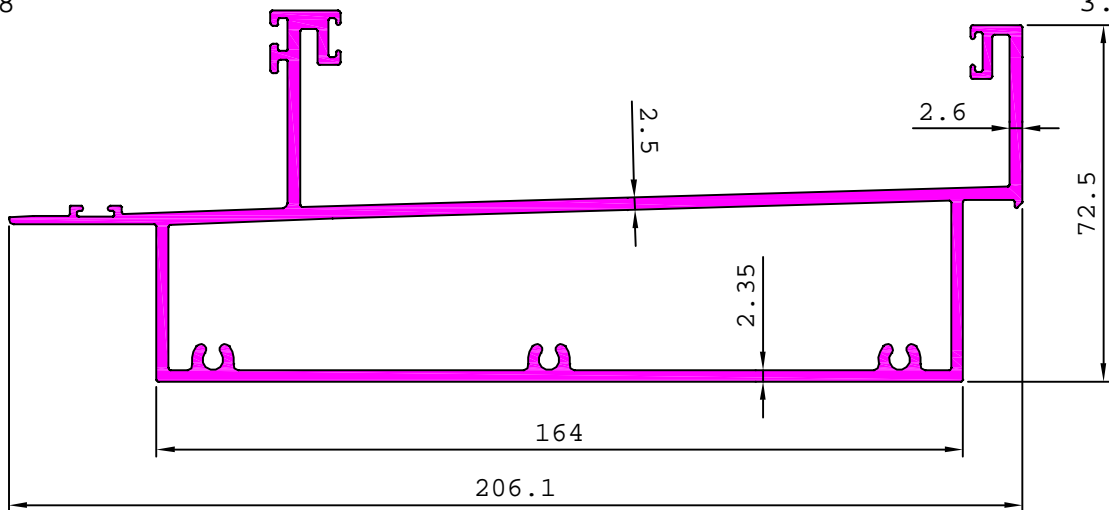

MATCHING WITH G102981

G102981

1.083 kg/m

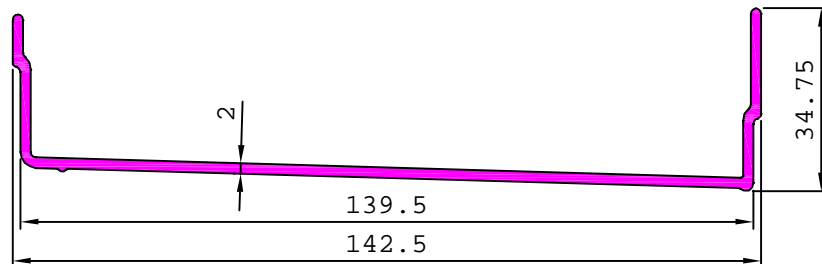

MATCHING WITH G102978

## CURTAIN WALL SECTION

G102979

2.990 kg/m

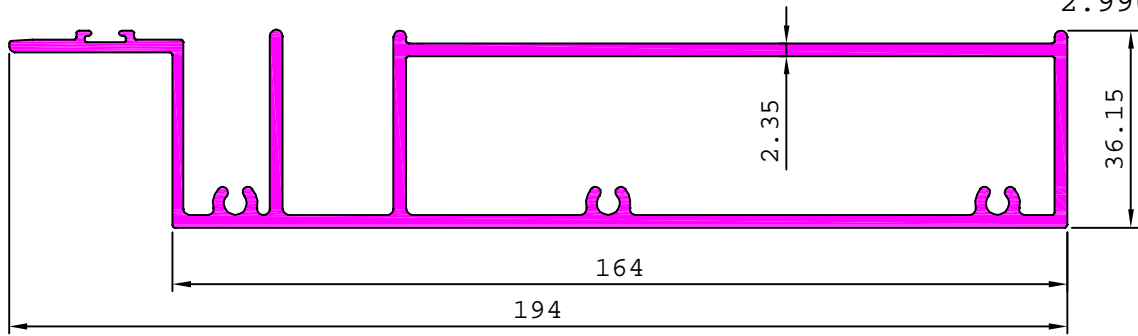

G102952

2.402 kg/m

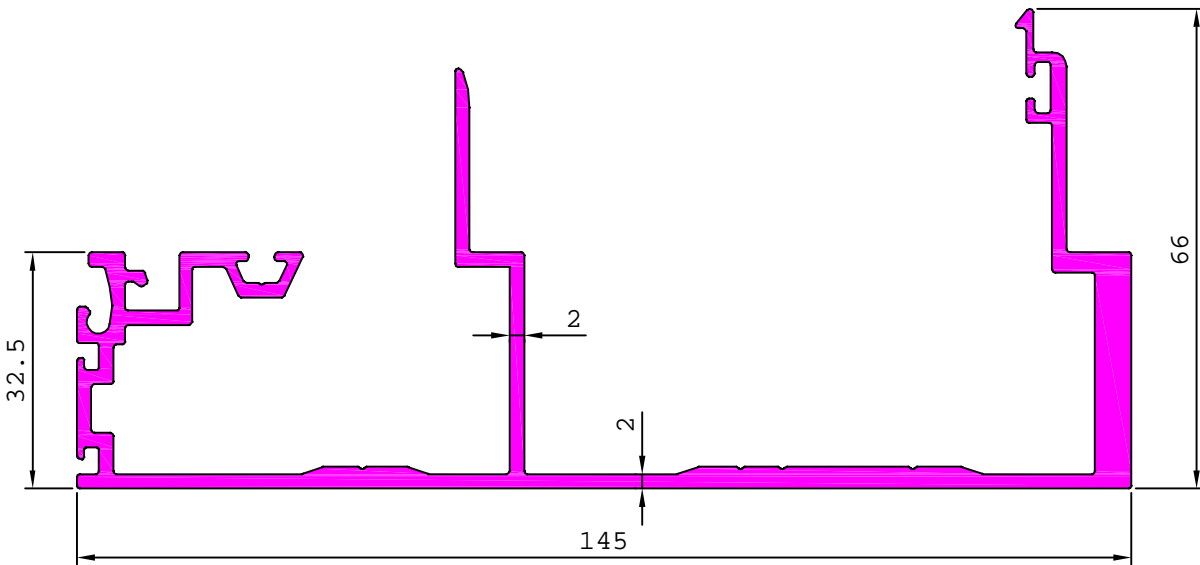

MATCHING WITH G102947, G102953

G102953

2.025 kg/m

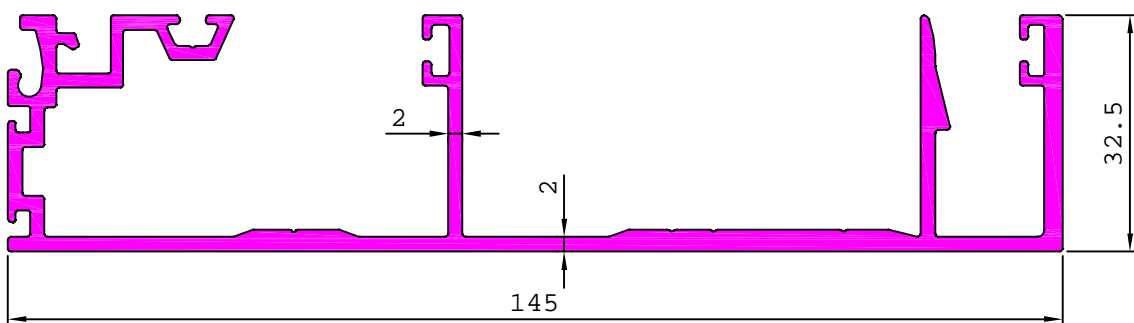

MATCHING WITH G102947, G102952

G102949

0.440 kg/m

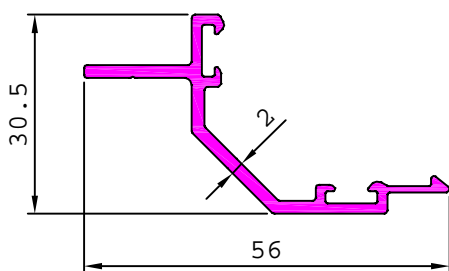

MATCHING WITH G102948, G102951

G102950

0.333 kg/m

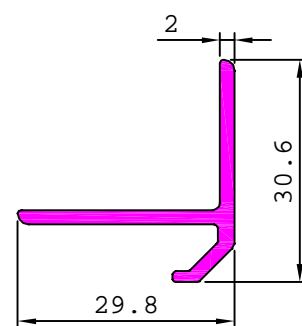

MATCHING WITH G102948, G102951

## CURTAIN WALL SECTION

G102972

0.472 kg/m

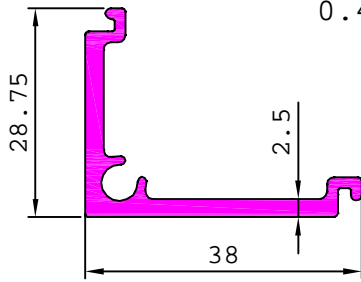

MATCHING WITH G102971

G102947

0.293 kg/m

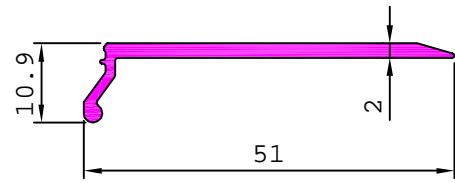

MATCHING WITH G102948,G102951

G103049

2.698 kg/m

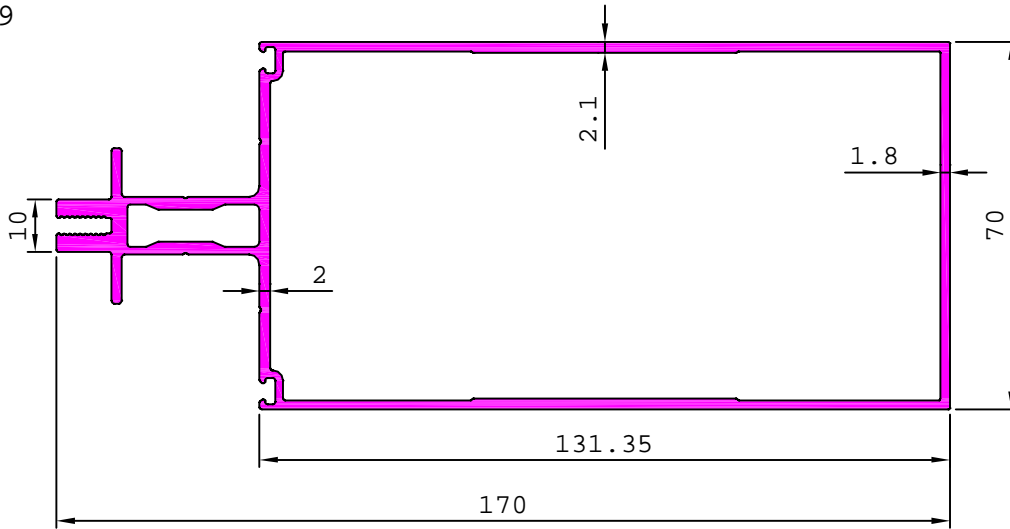

G103129

4.697 kg/m

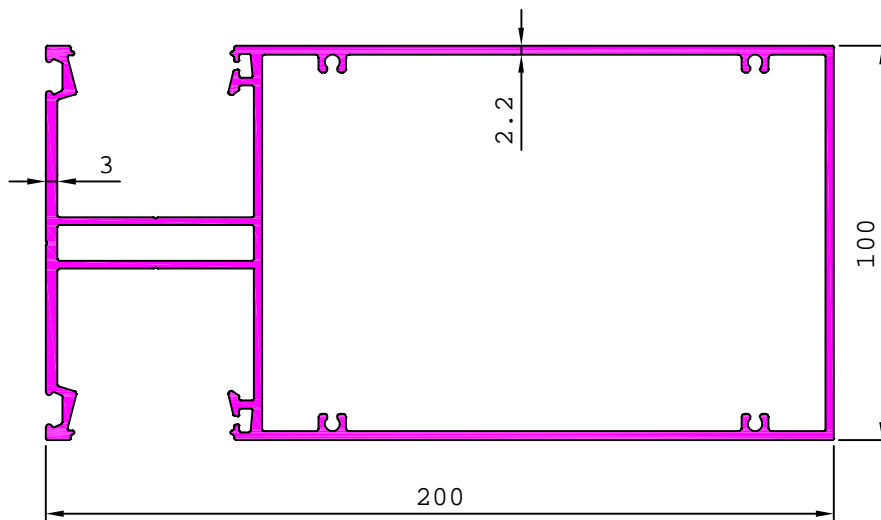

MATCHING WITH G103130

G103130

0.240 kg/m

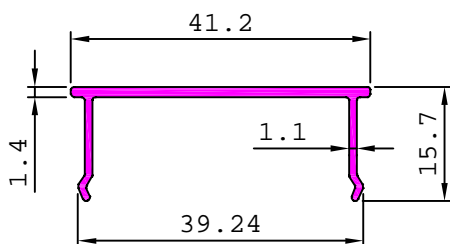

MATCHING WITH G103129

G103222

0.254 kg/m

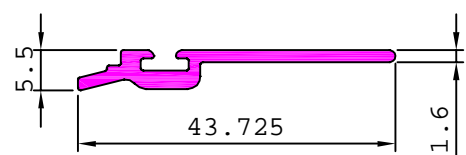

MATCHING WITH G103219,G103220 & G103229

# CURTAIN WALL SECTION

G103178

3.367 kg/m

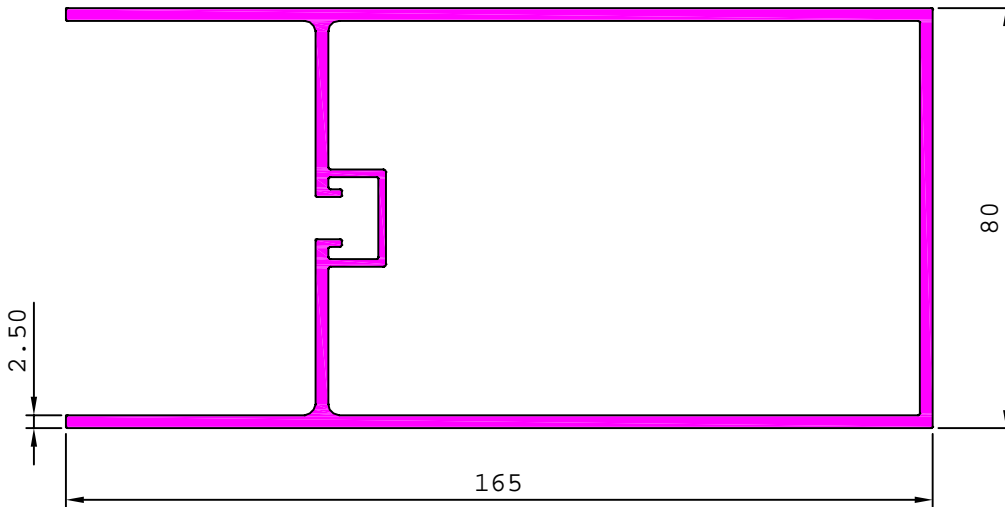

G103179

2.738 kg/m

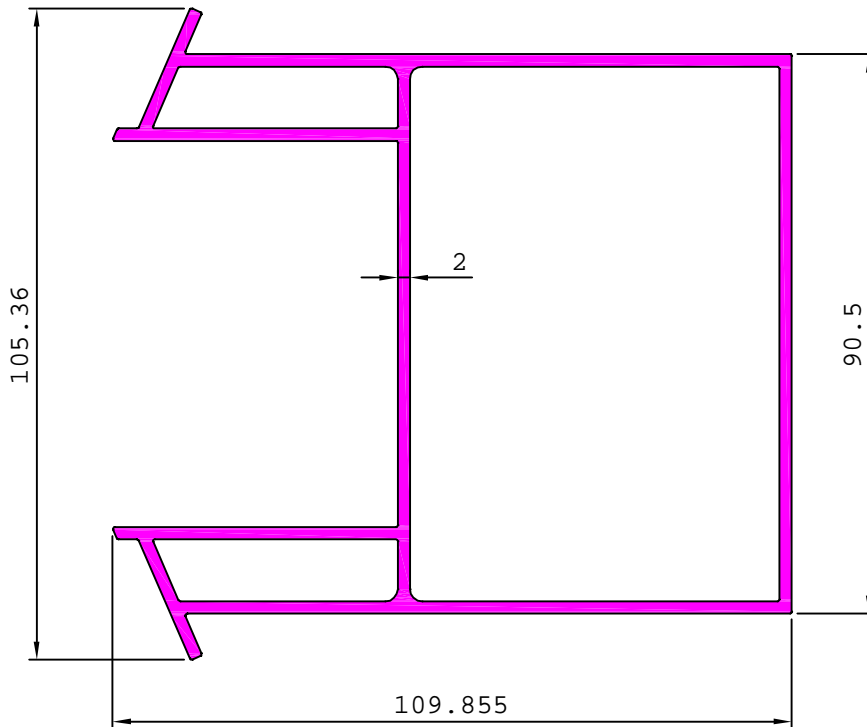

G103234

4.037 kg/m

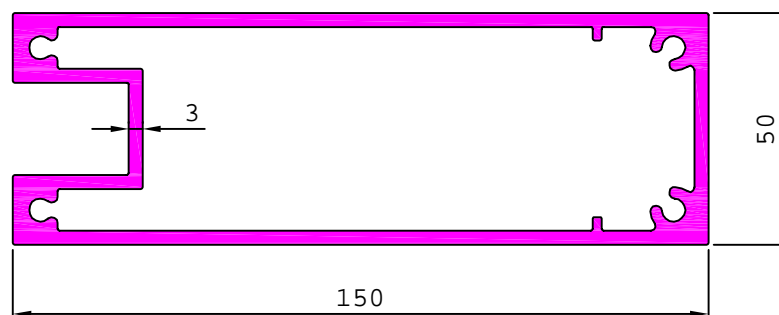

**CURTAIN WALL SECTION**

G103217

1.798 kg/m

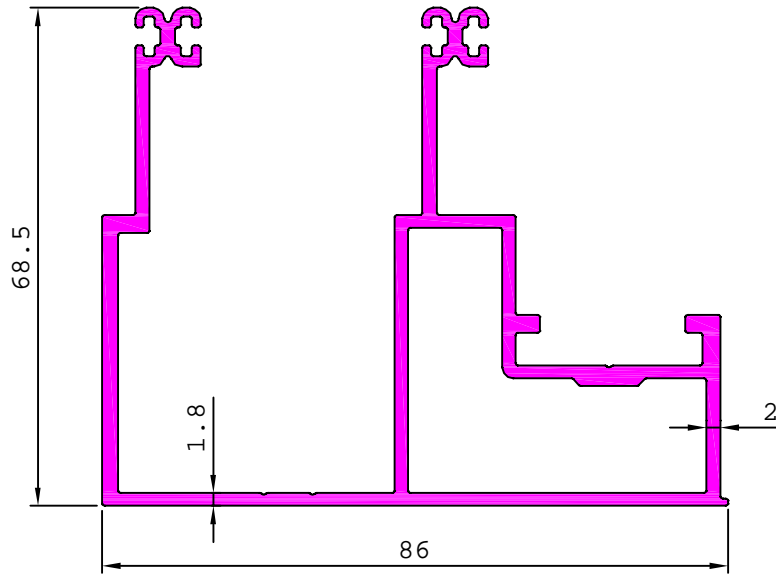

MATCHING WITH G103218,G103223

G103219

2.345 kg/m

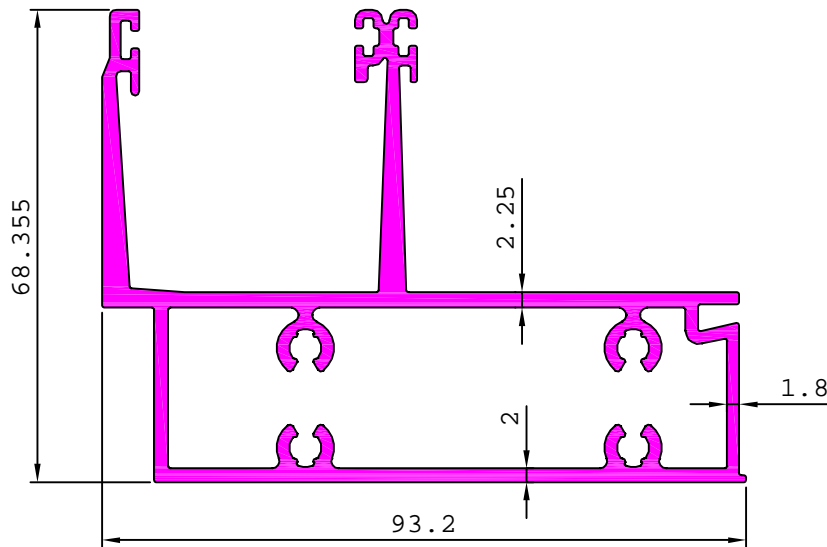

MATCHING WITH G103219,G103220,G103222,G103230

G103221

2.102 kg/m

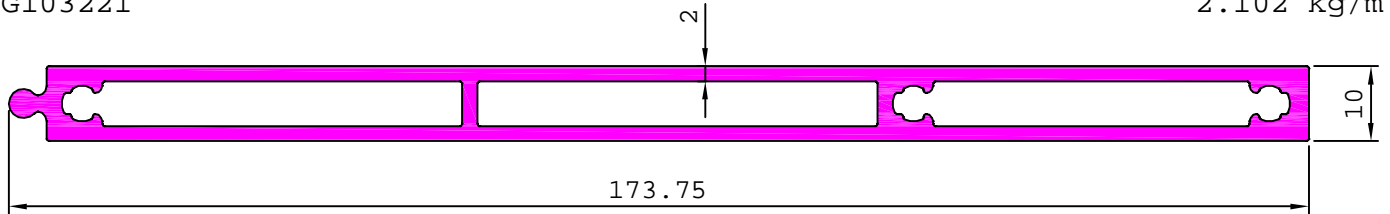

MATCHING WITH G103223

G103223

2.245 kg/m

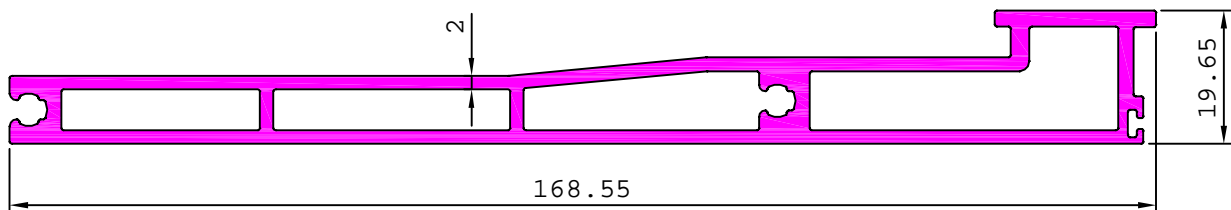

MATCHING WITH G103217,G103218,G103221

## CURTAIN WALL SECTION

G103232

3.692 kg/m

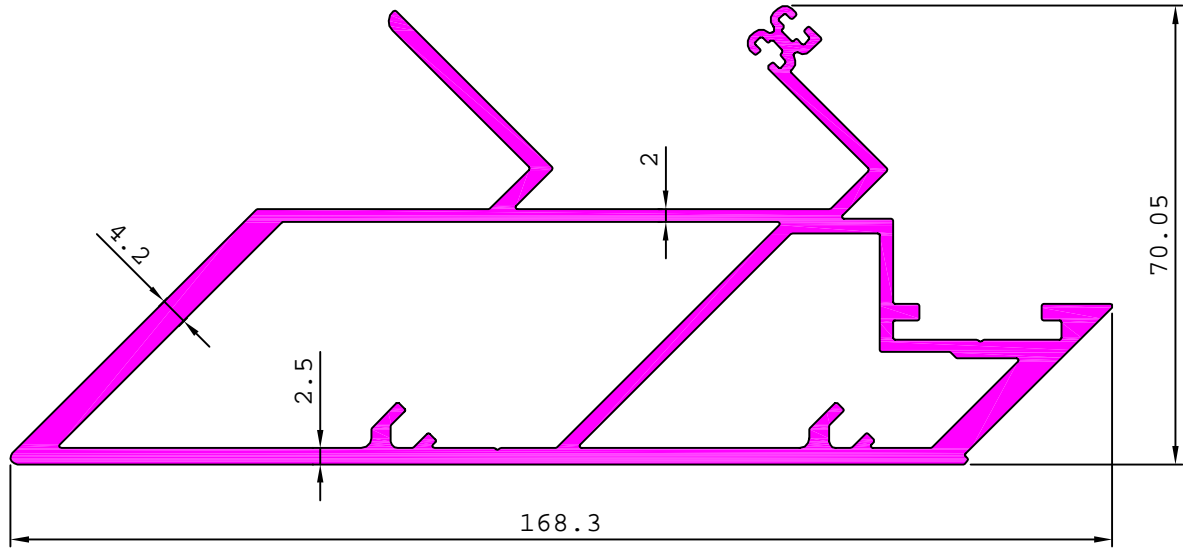

G103218

1.659 kg/m

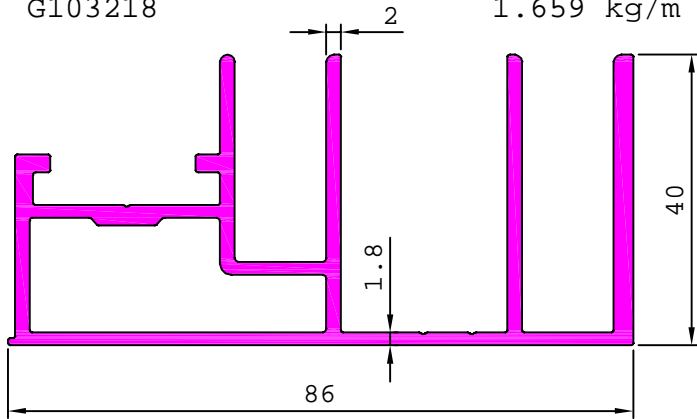

MATCHING WITH G103217,G103223

G103220

2.047 kg/m

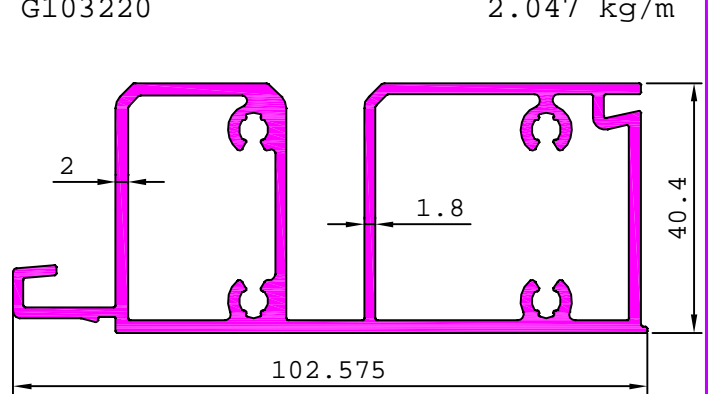

MATCHING WITH G103219,G103222

G103229

1.887 kg/m

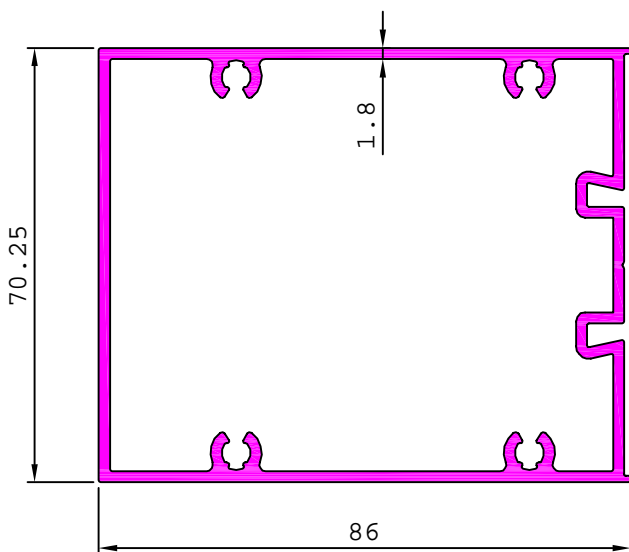

MATCHING WITH G103222

G103239

4.691 kg/m

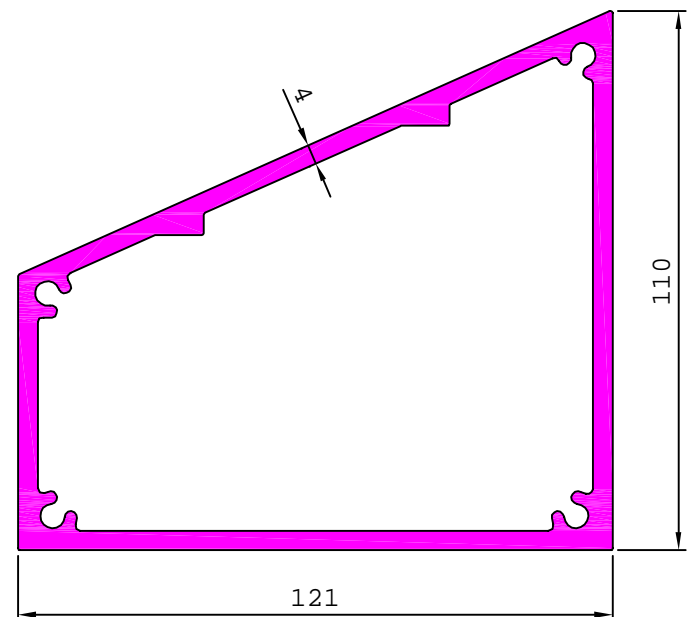

# CURTAIN WALL SECTION

G103233

3.415 kg/m

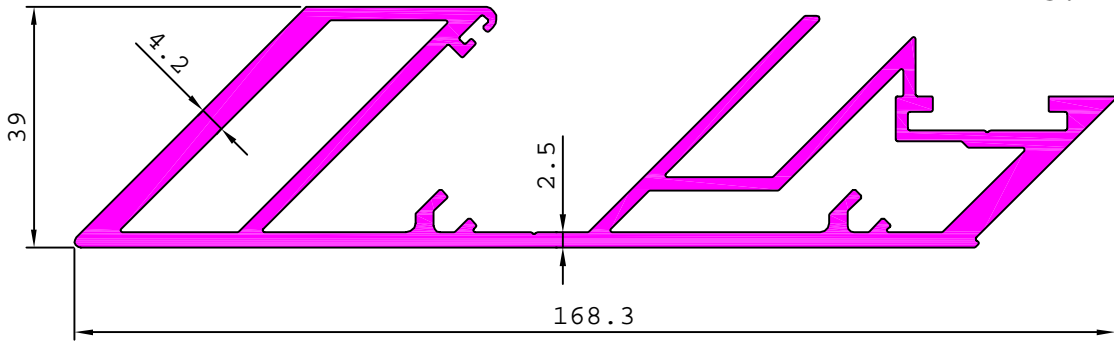

G103238

4.432 kg/m

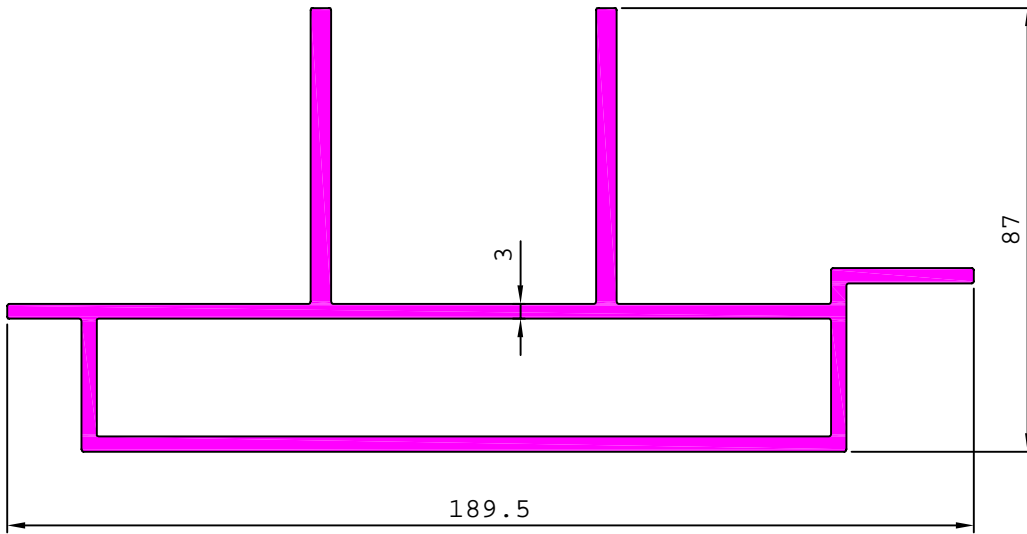

G103240

4.548 kg/m

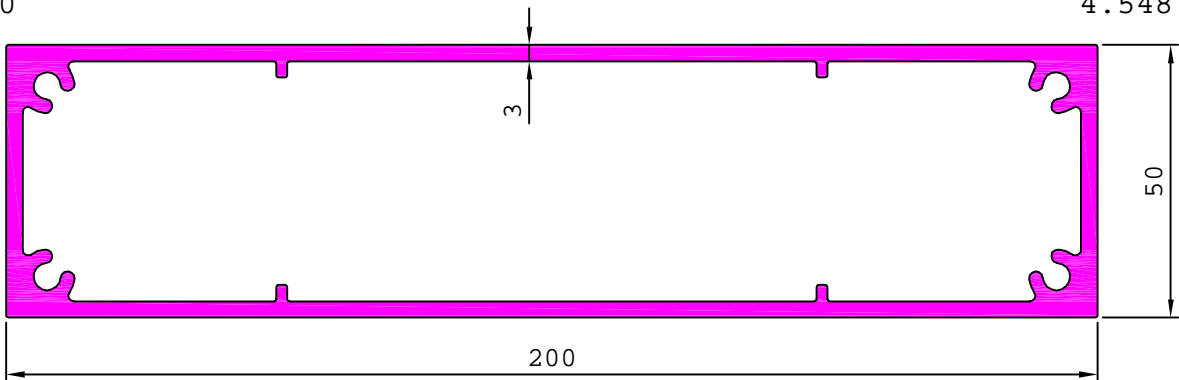

G103235

4.251 kg/m

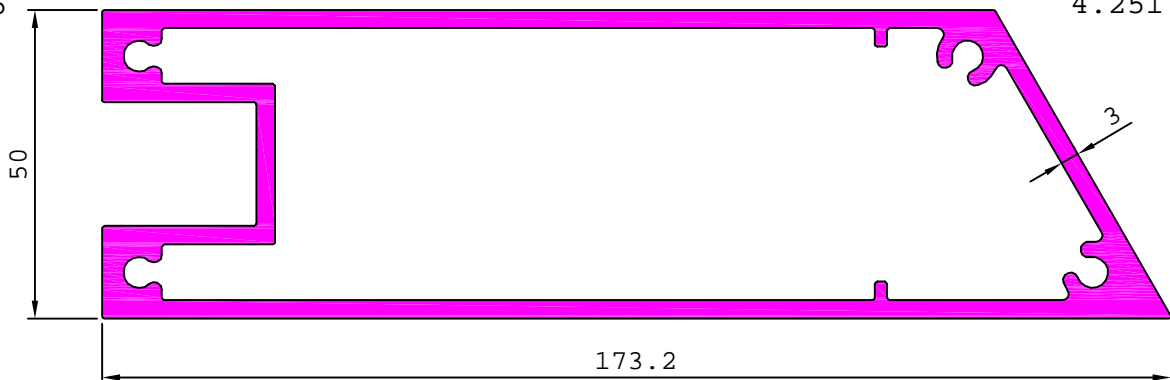

## CURTAIN WALL SECTION

G103215

1.840 kg/m

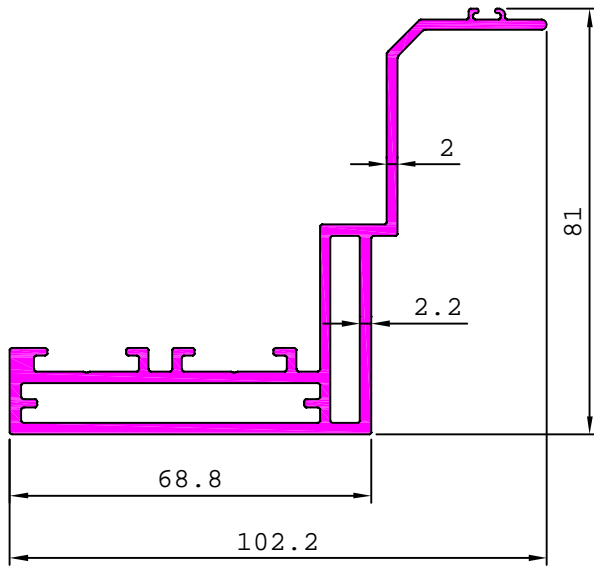

G103216

1.878 kg/m

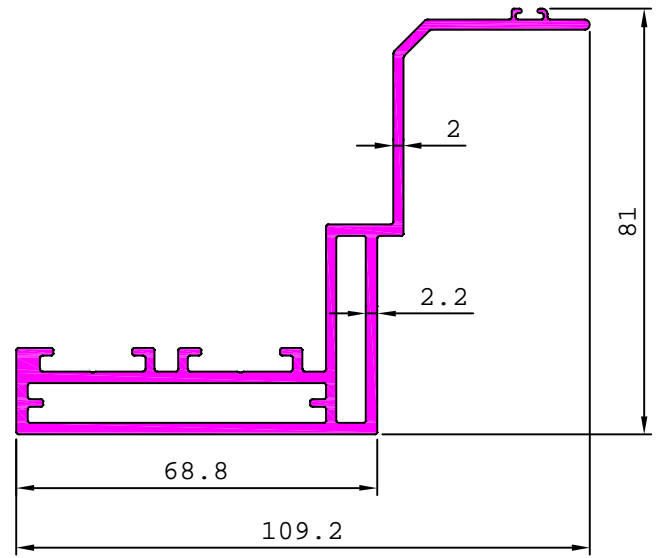

G103224

1.563 kg/m

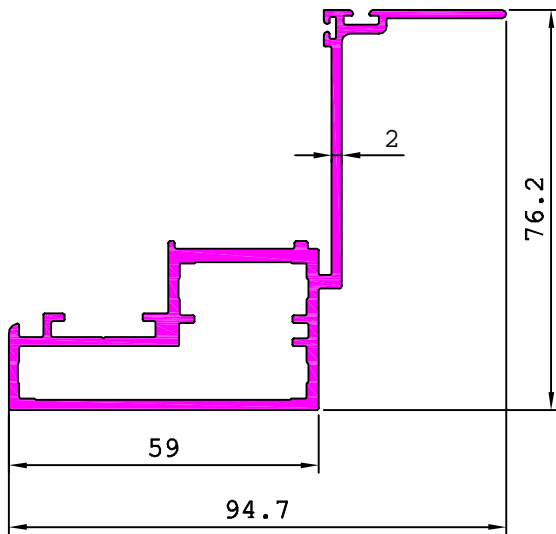

G103287

1.812 kg/m

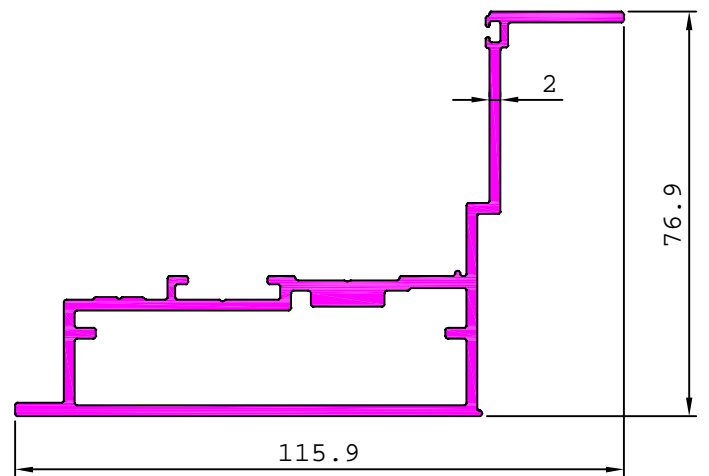

G103236

2.144 kg/m

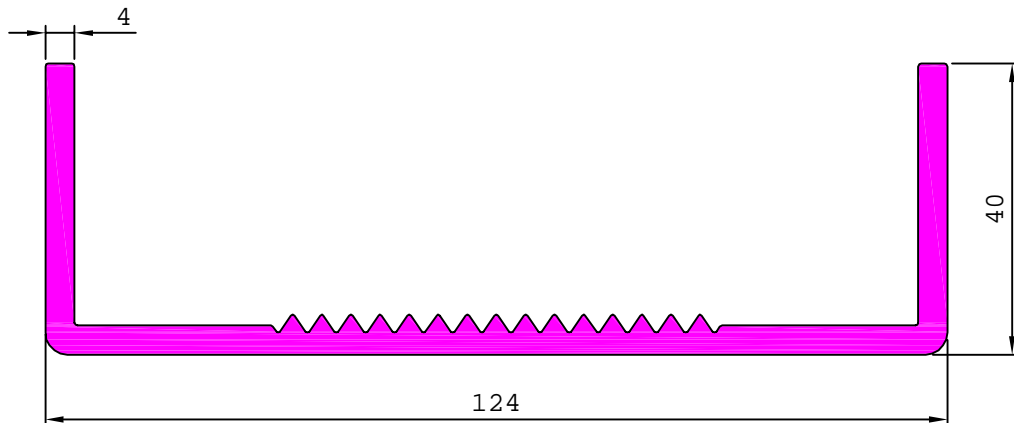

## CURTAIN WALL SECTION

G103231 0.254 kg/m

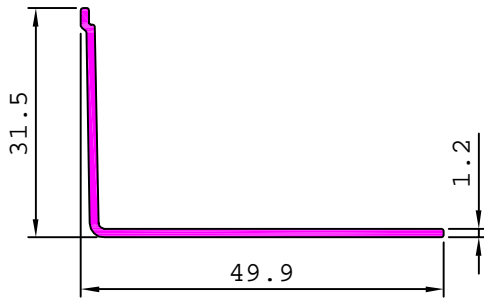

MATCHING WITH G103219

G103230 0.737 kg/m

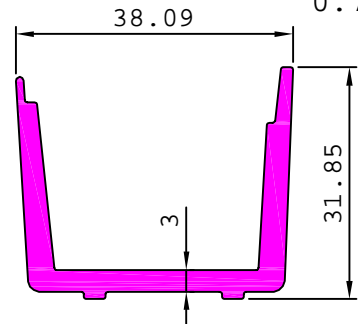

MATCHING WITH G103219

G103180 2.561 kg/m

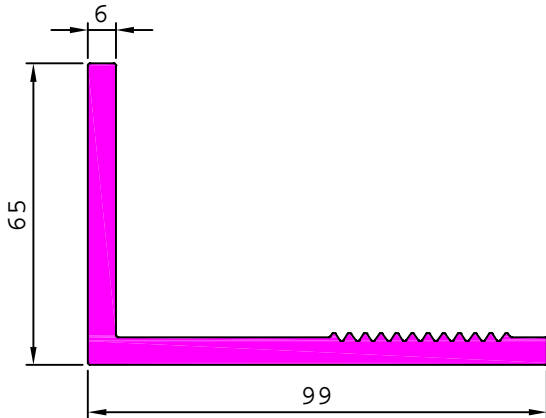

G103181 0.660 kg/m

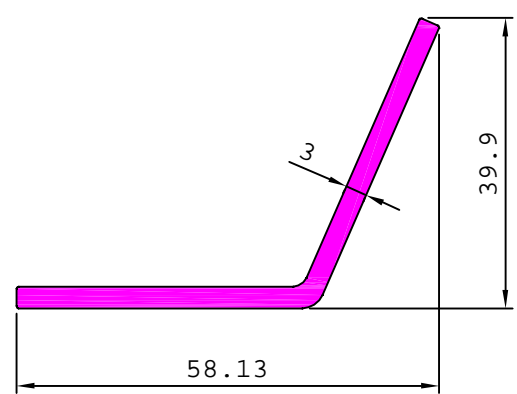

G103286 1.351 kg/m

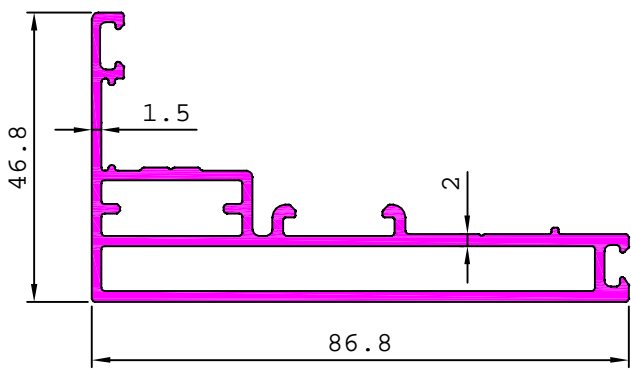

G103237 2.804 kg/m

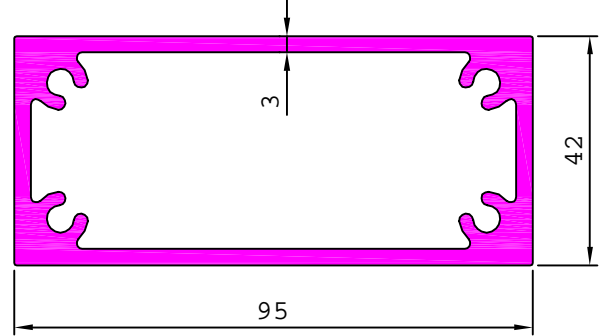

G103213 0.340 kg/m

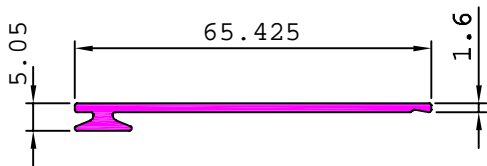

MATCHING WITH S6803,S6804

G103214 0.388 kg/m

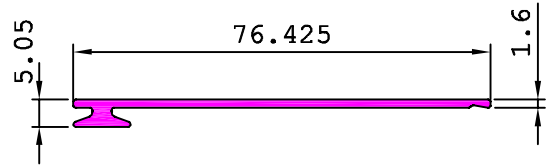

MATCHING WITH S6803,S6804

G103195 0.287 kg/m

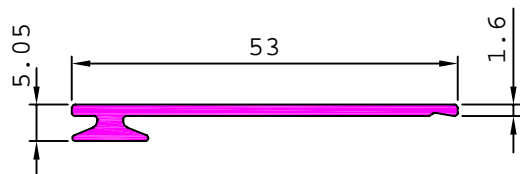

MATCHING WITH 36230,36231

G103196 0.256 kg/m

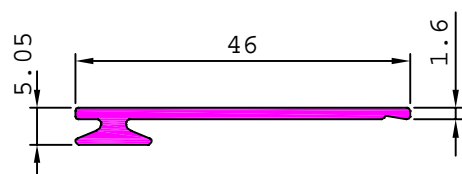

MATCHING WITH 36230,36231

## CURTAIN WALL SECTION

G103193

0.426 kg/m

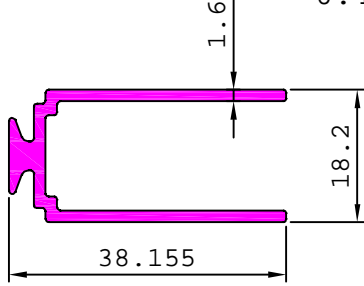

MATCHING WITH 36229

G103194

0.366 kg/m

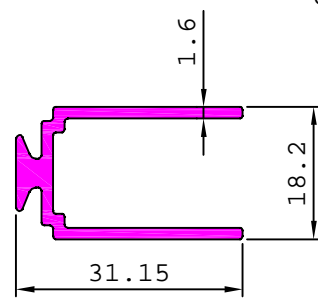

MATCHING WITH 36229

G103227

0.615 kg/m

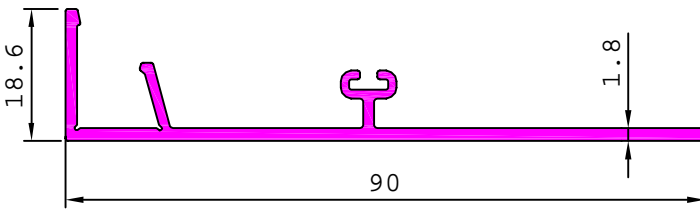

G103418

0.212 kg/m

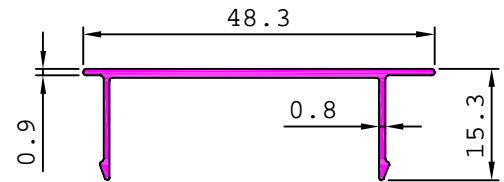

MATCHING WITH G103417

G103407

2.022 kg/m

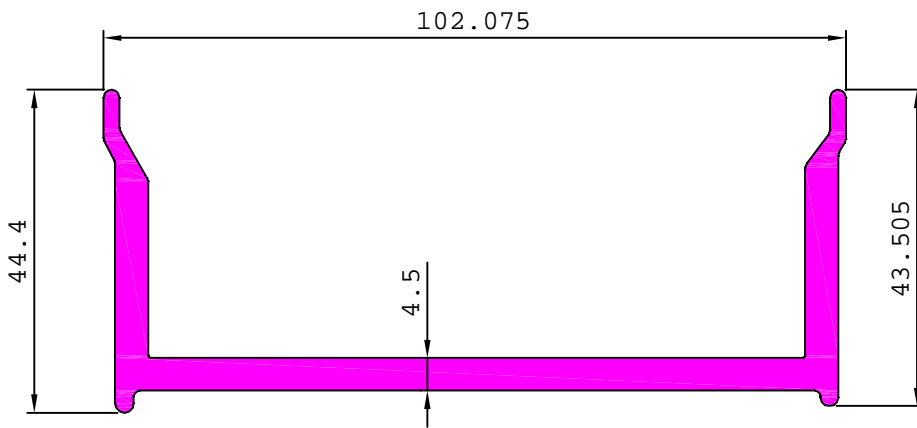

MATCHING WITH G103410

G103412

1.122 kg/m

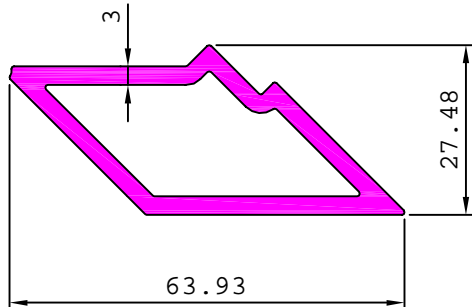

G103516

0.592 kg/m

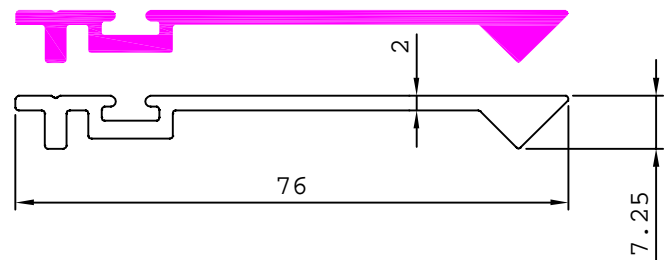

# CURTAIN WALL SECTION

G103330

9.916 kg/m

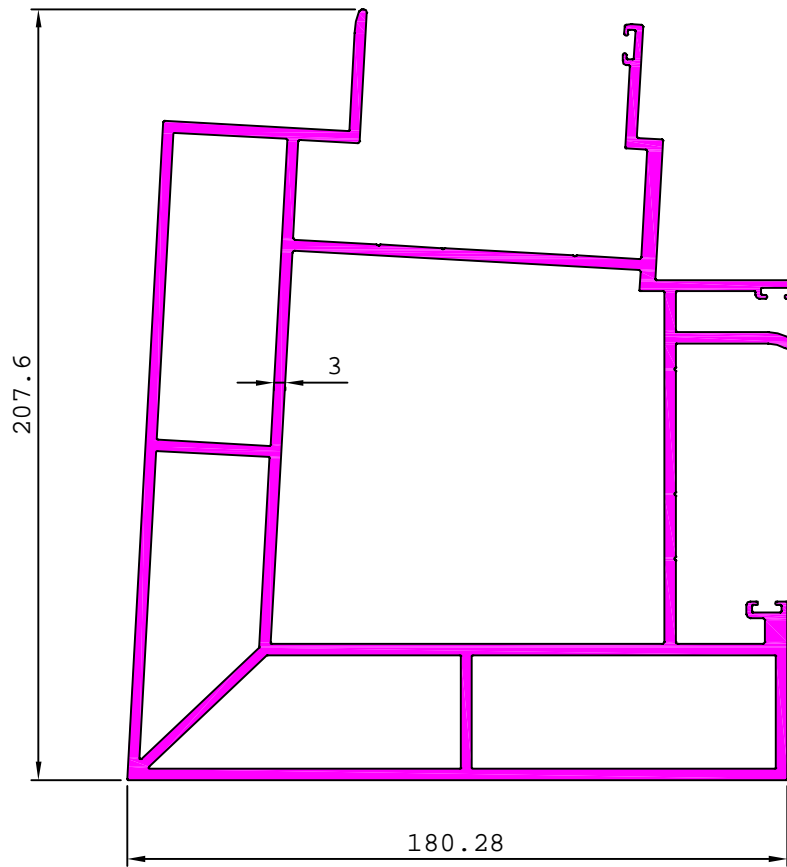

G103331

10.030 kg/m

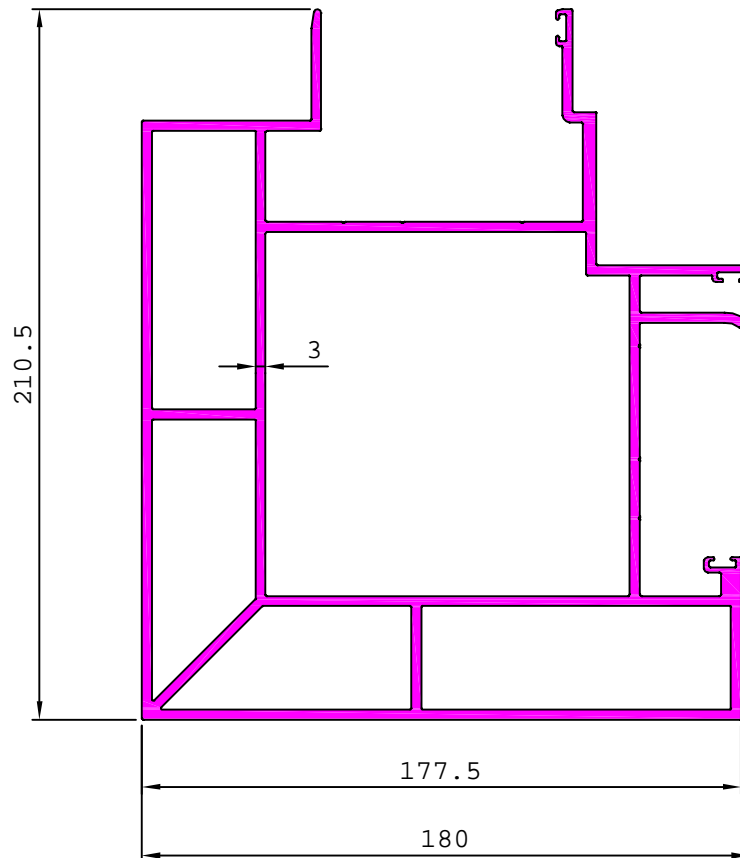

# CURTAIN WALL SECTION

G103417

8.336 kg/m

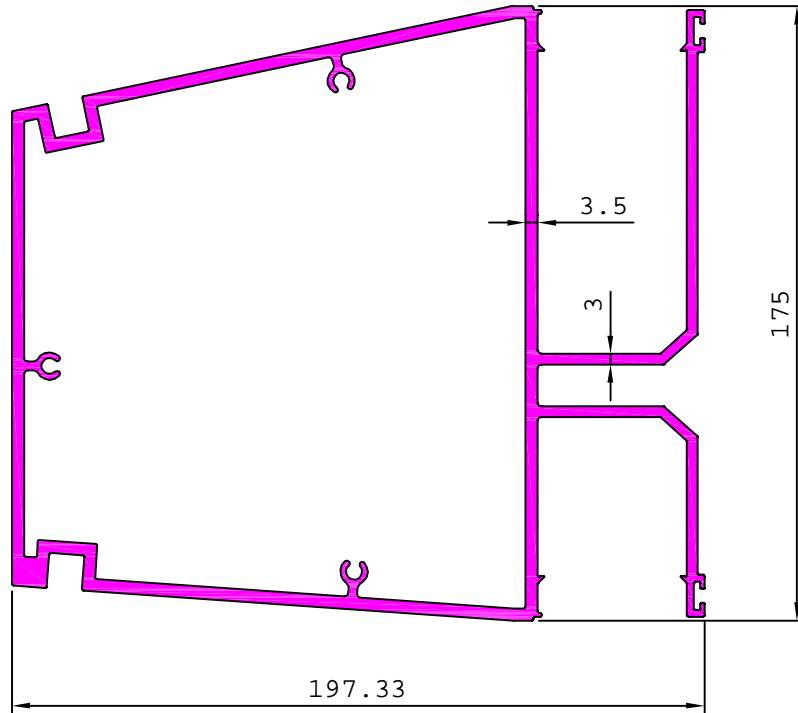

MATCHING WITH G103418

G103420

4.187 kg/m

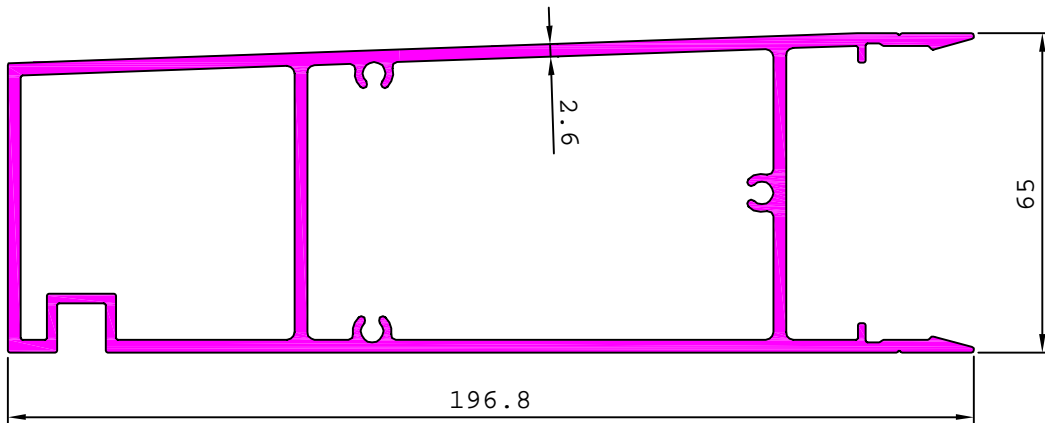

G103419

1.855 kg/m

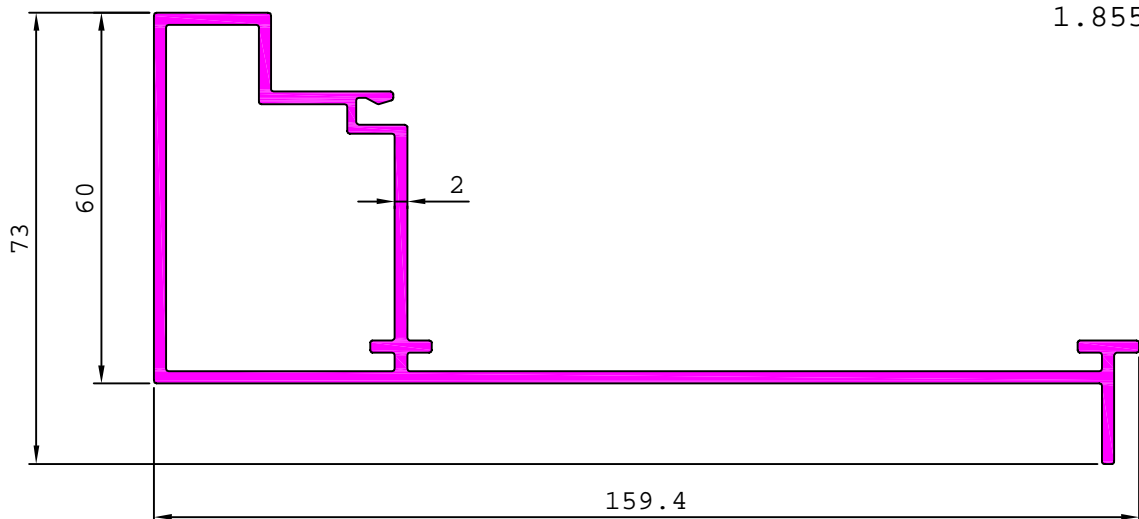

# CURTAIN WALL SECTION

G103405

3.179 kg/m

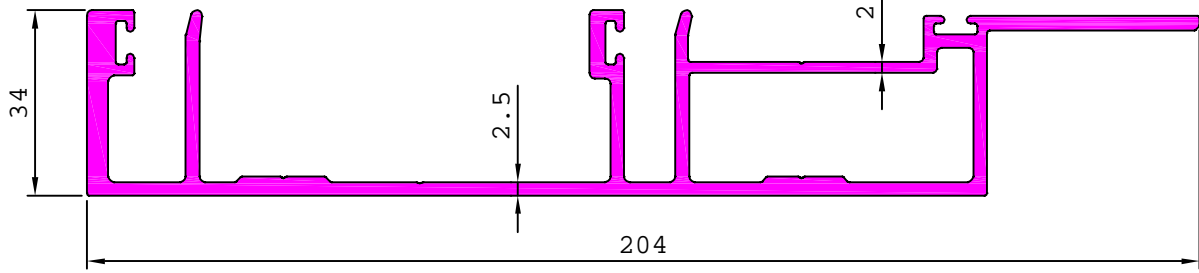

MATCHING WITH G103406

G103406

3.261 kg/m

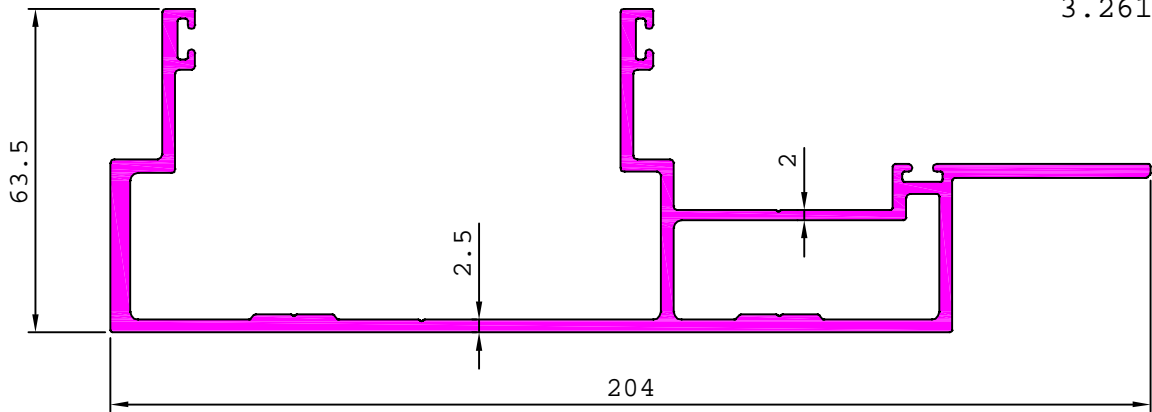

MATCHING WITH G103405

G103409

3.241 kg/m

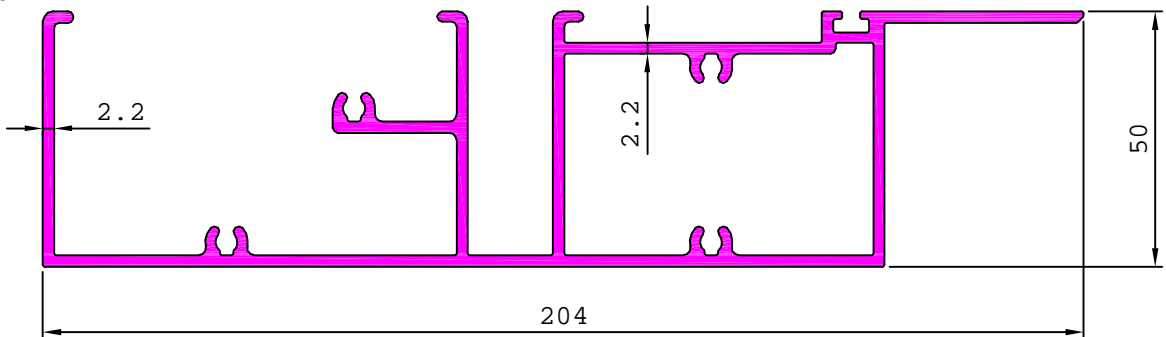

G103410

4.119 kg/m

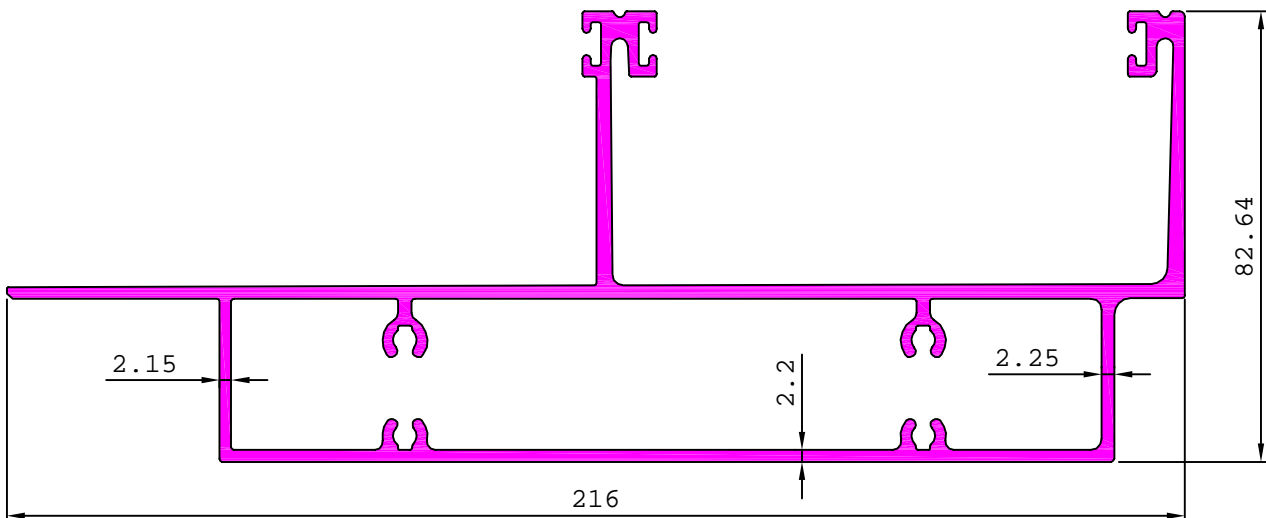

## CURTAIN WALL SECTION

G103408

3.667 kg/m

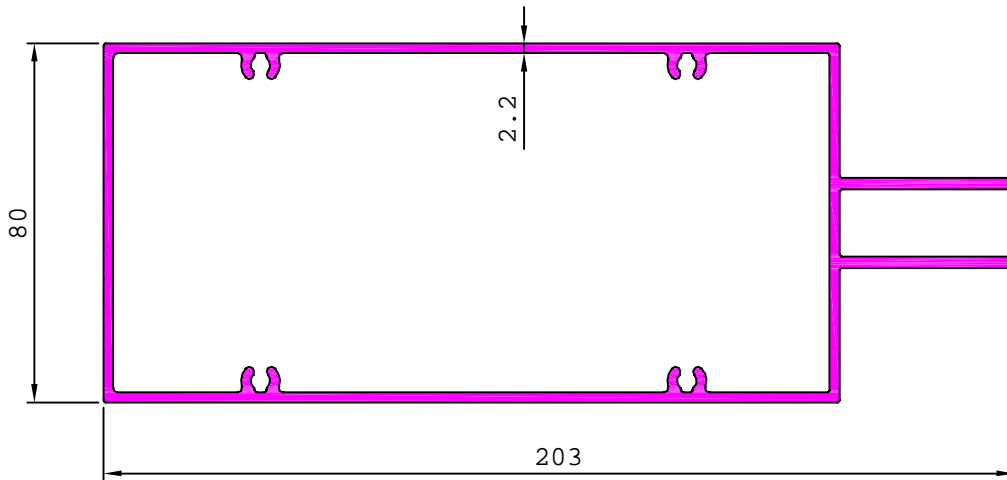

G103376

2.596 kg/m

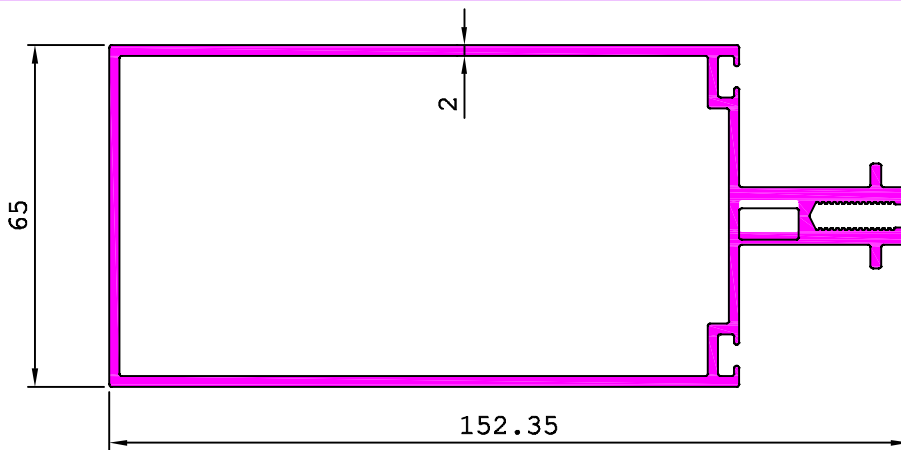

G103377

2.320 kg/m

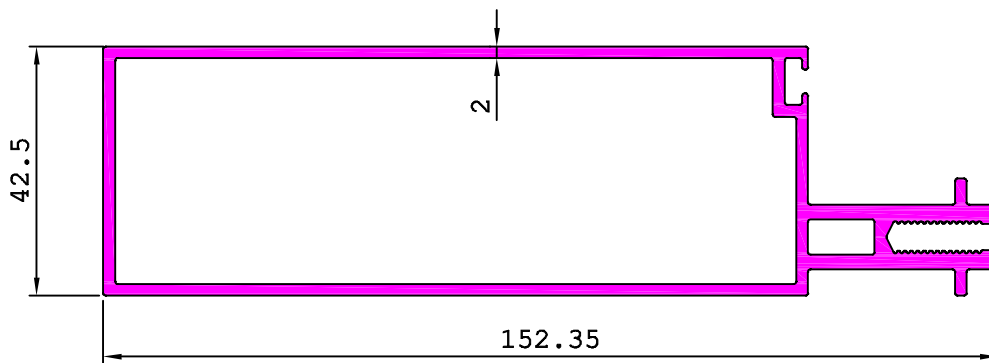

G103504

3.462 kg/m

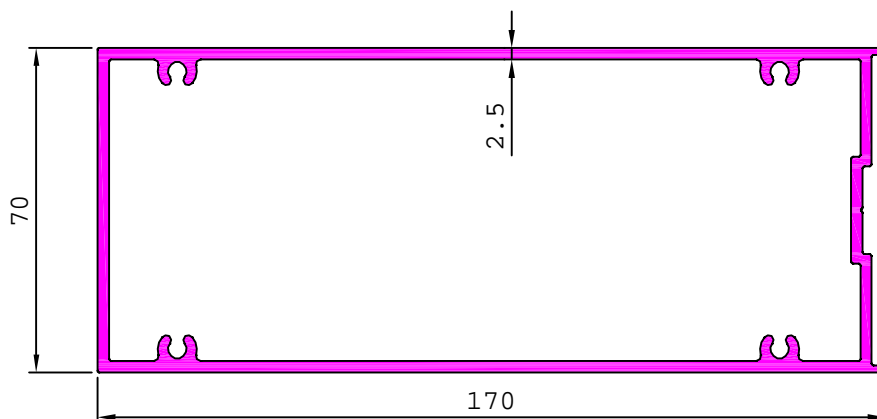

## CURTAIN WALL SECTION

G103595

4.806 kg/m

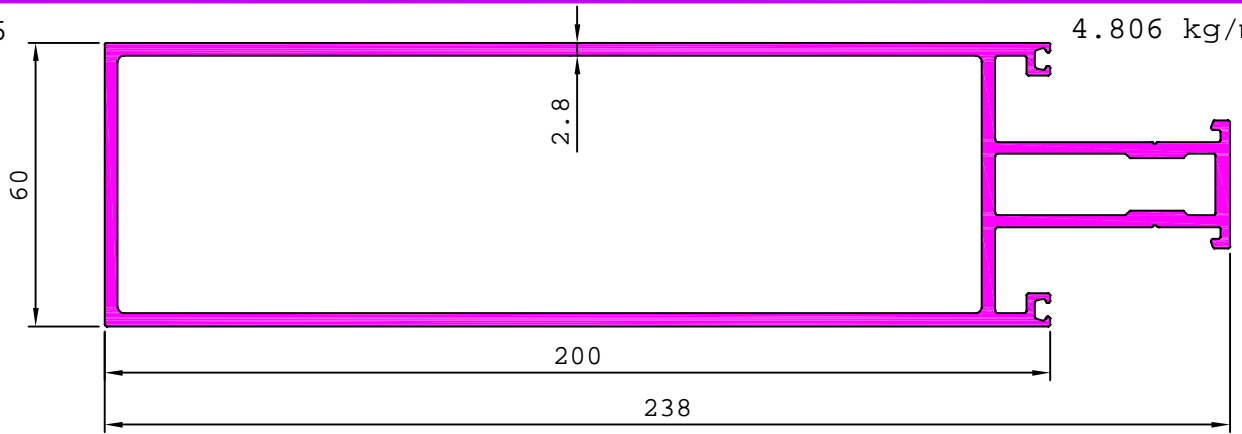

G103594

3.487 kg/m

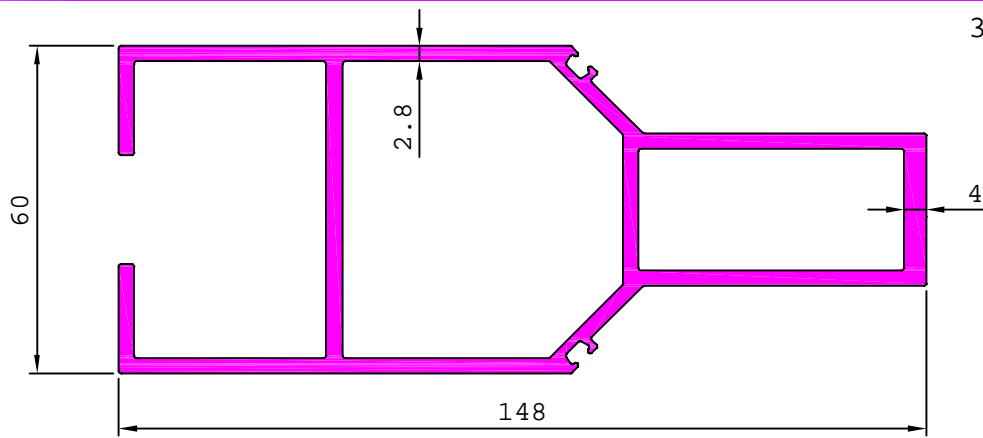

G103531

3.502 kg/m

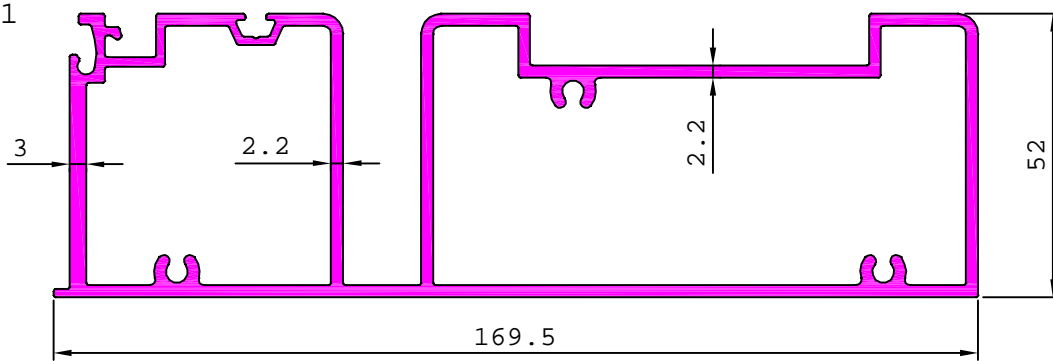

G103513

1.849 kg/m

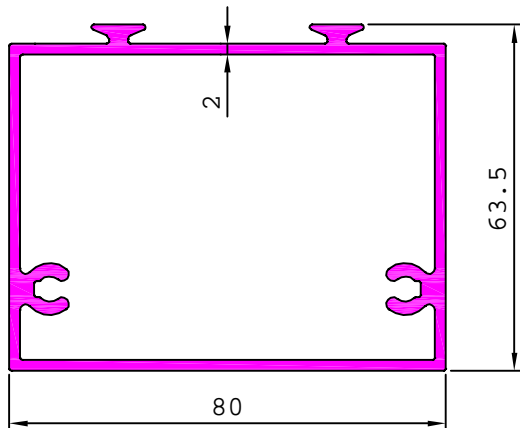

MATCHING WITH G103511,G103512

G103657

0.659 kg/m

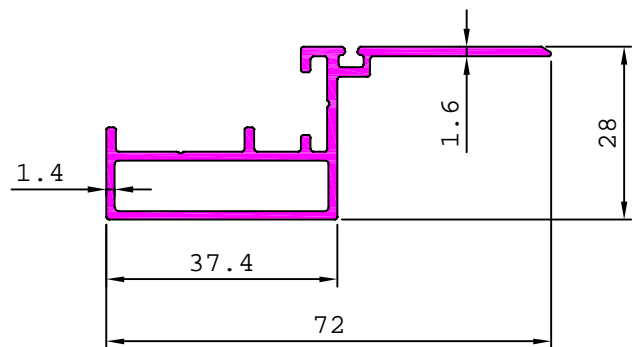

MATCHING WITH 29073

## CURTAIN WALL SECTION

G103506

4.155 kg/m

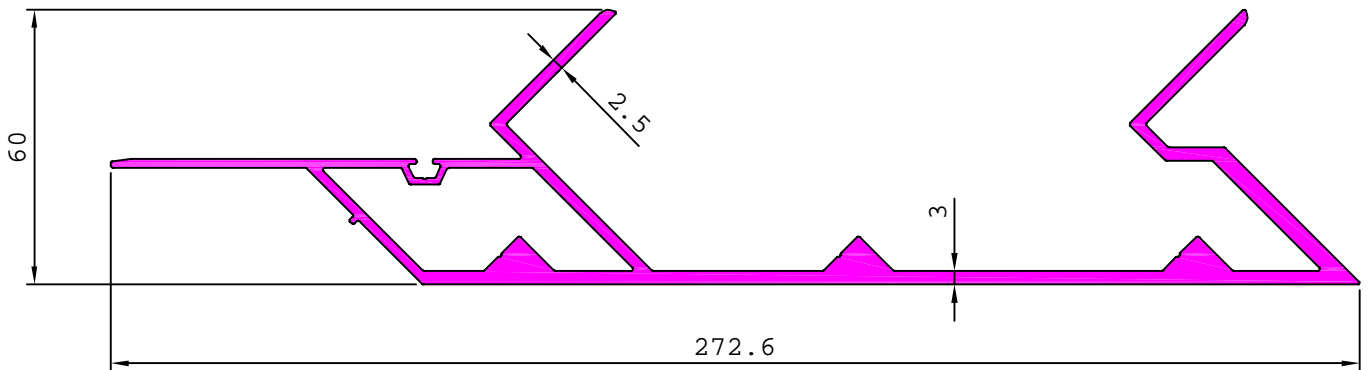

MATCHING WITH G103507

G103507

3.537 kg/m

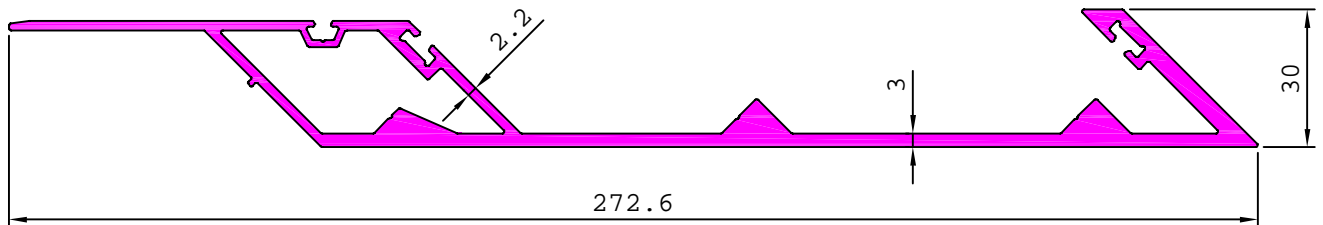

MATCHING WITH G103506

G103514

4.658 kg/m

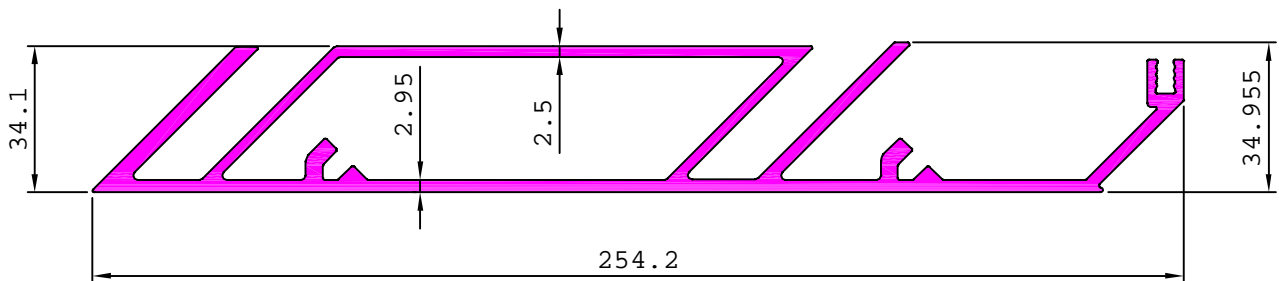

MATCHING WITH G103515

G103515

5.661 kg/m

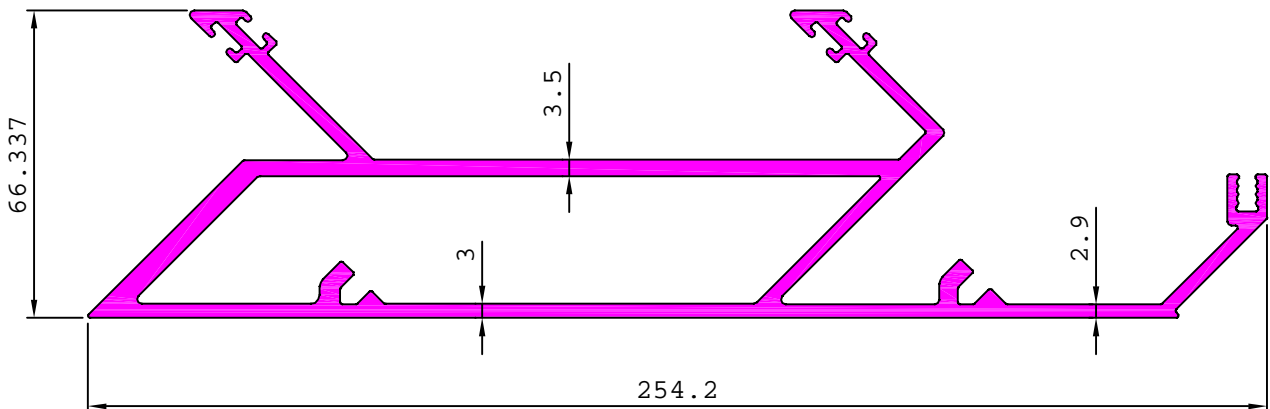

MATCHING WITH G103514

## CURTAIN WALL SECTION

G103511

2.855 kg/m

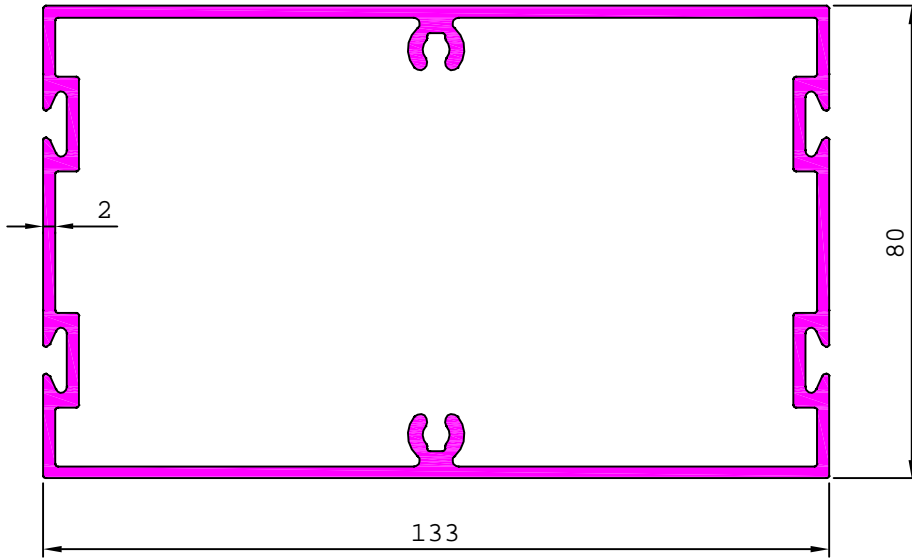

MATCHING WITH G103512,G103513

G103512

2.638 kg/m

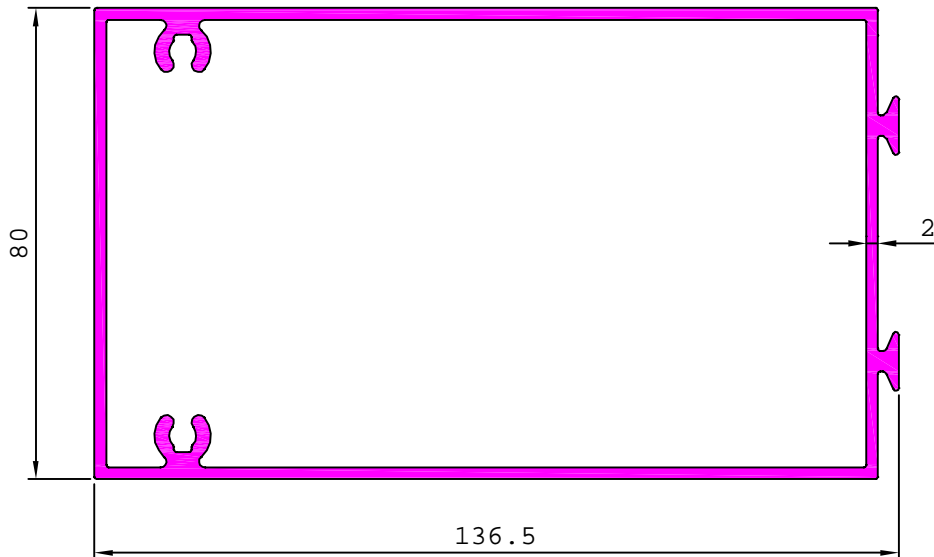

MATCHING WITH G103511,G103513

G103600

2.118 kg/m

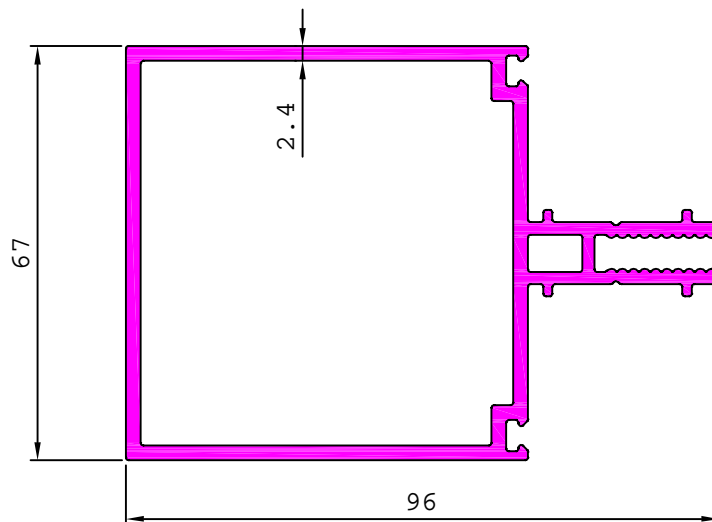

## CURTAIN WALL SECTION

G103655

4.159 kg/m

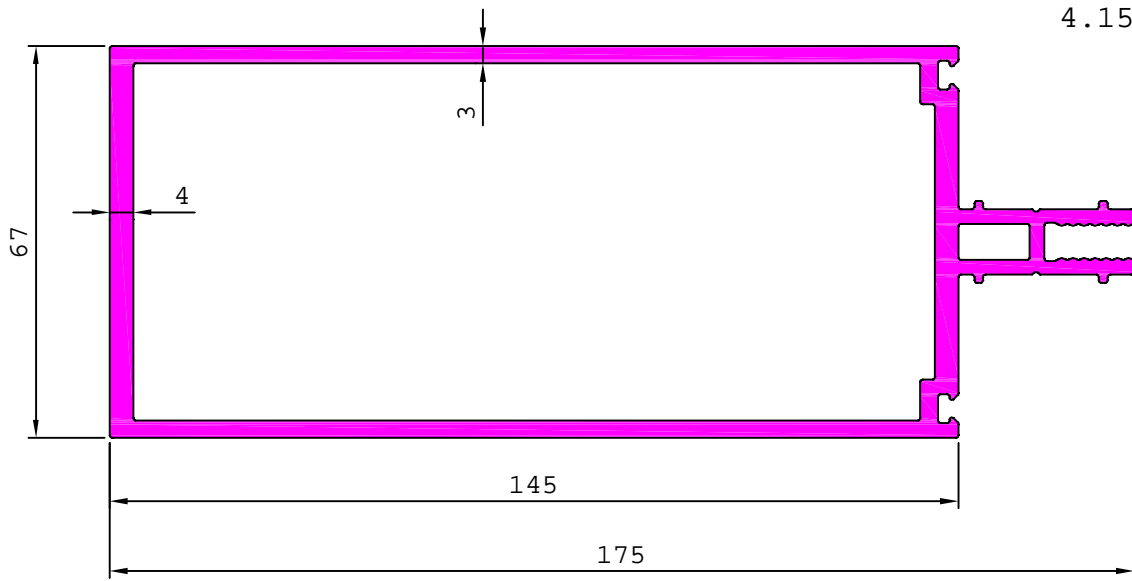

G103656

2.783 kg/m

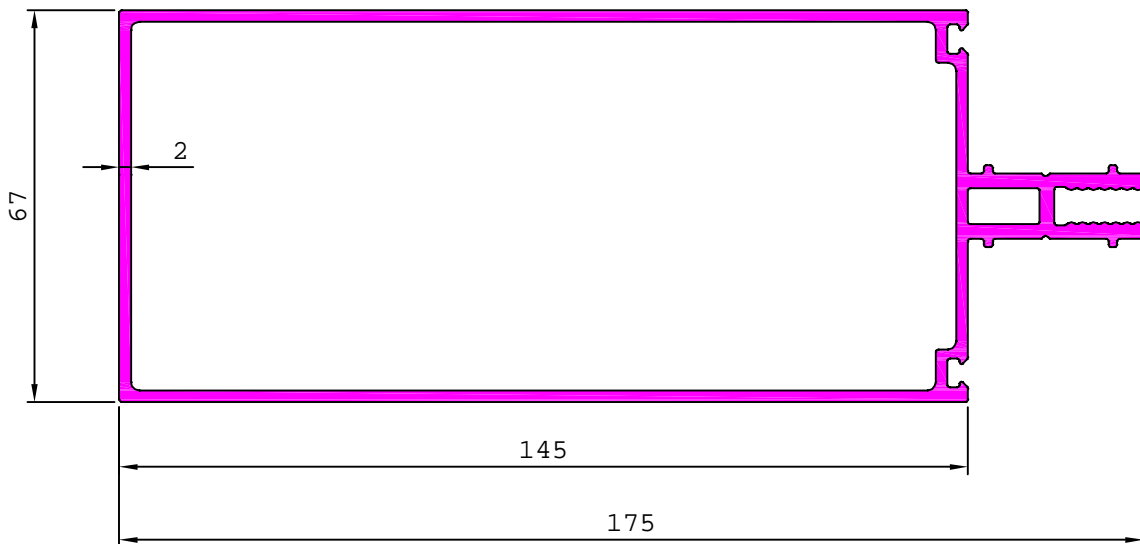

G103689

3.394 kg/m

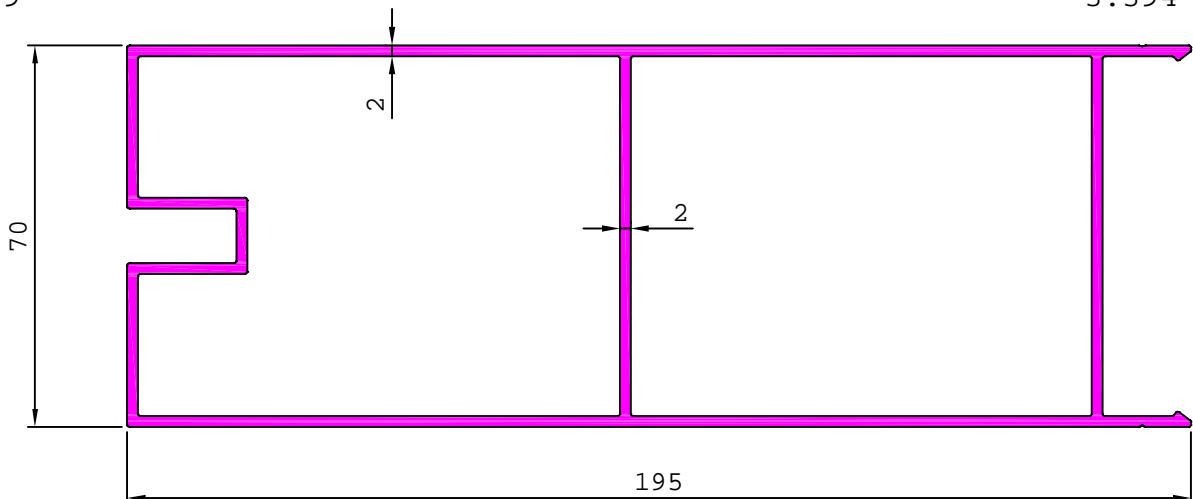

MATCHING WITH G103691

## CURTAIN WALL SECTION

G103690

2.428 kg/m

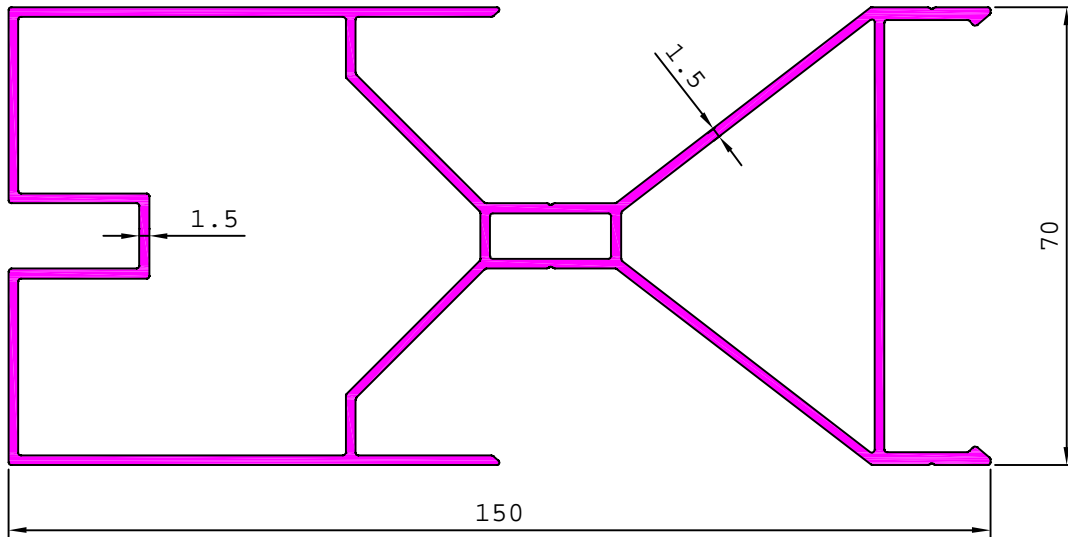

MATCHING WITH G103691

G103691

0.774 kg/m

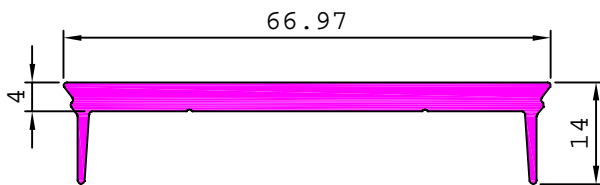

MATCHING WITH G103689,G103690

G103728

0.317 kg/m

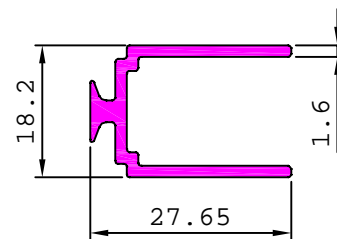

MATCHING WITH 36229

G103712

4.871 kg/m

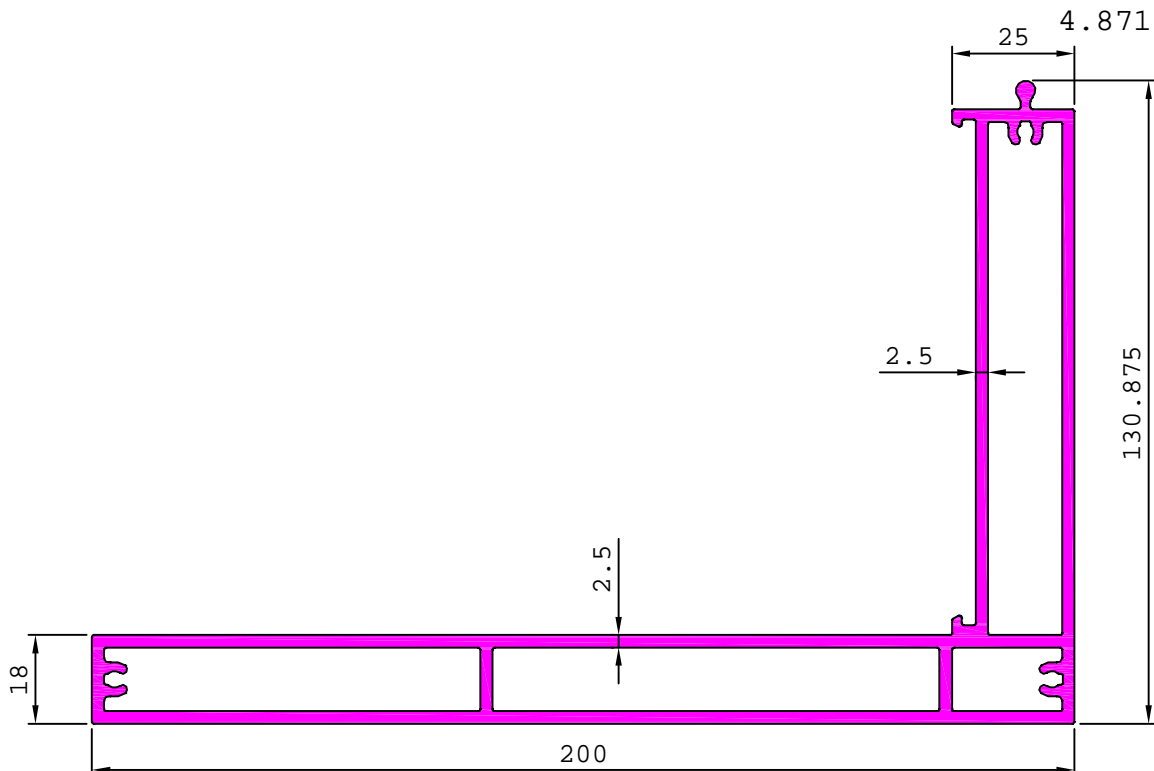

MATCHING WITH G103711,G103713

# CURTAIN WALL SECTION

G103702

3.368 kg/m

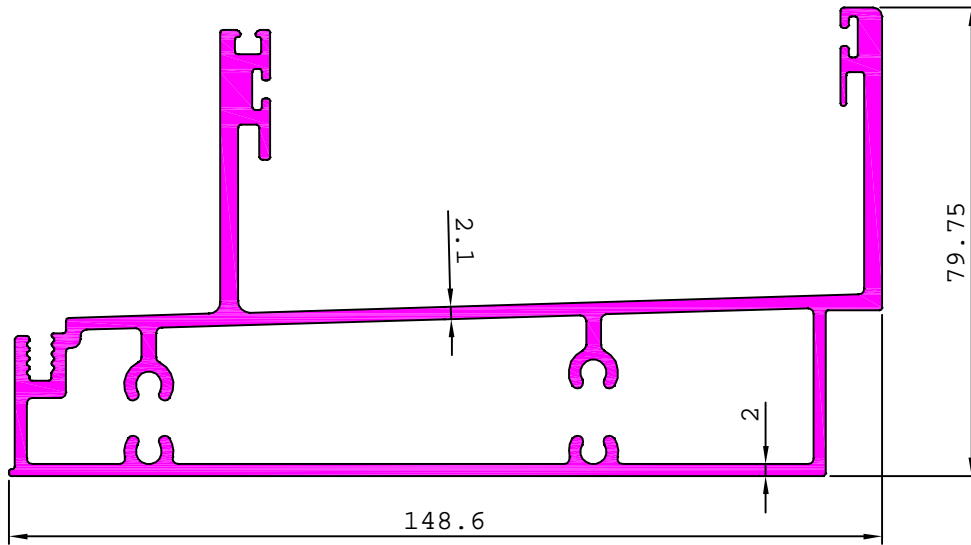

MATCHING WITH G103705,G103706

G103705

3.011 kg/m

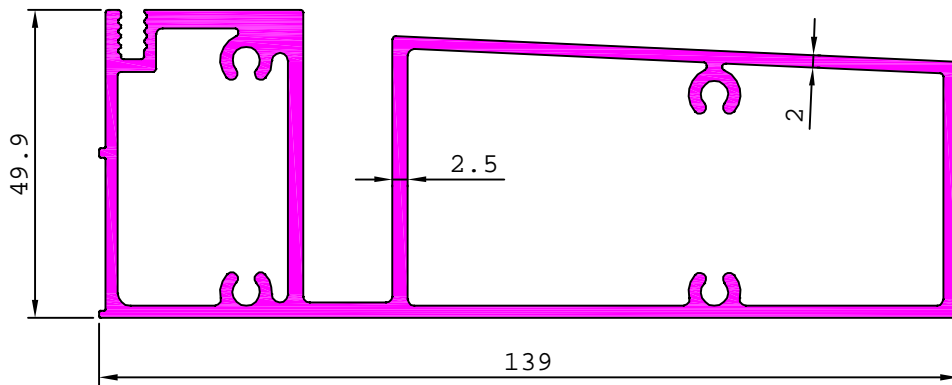

MATCHING WITH G103702 ,G103706

G103743

5.690 kg/m

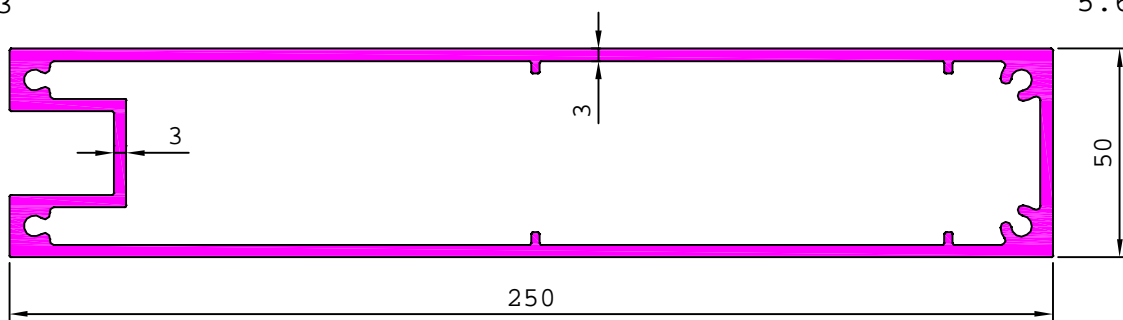

G103713

3.249 kg/m

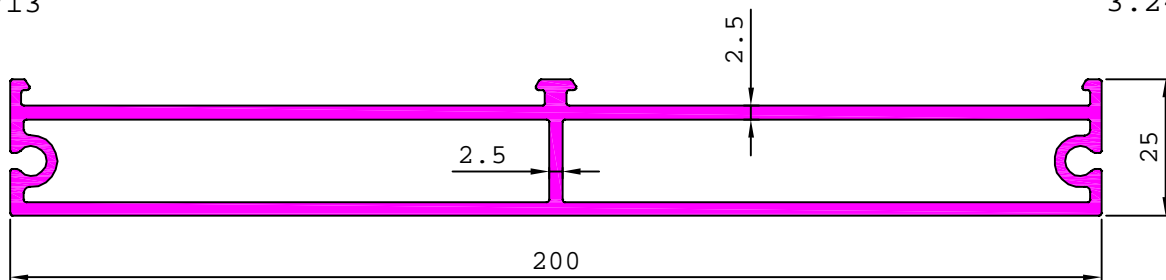

MATCHING WITH G103711,G103712

# CURTAIN WALL SECTION

G103711

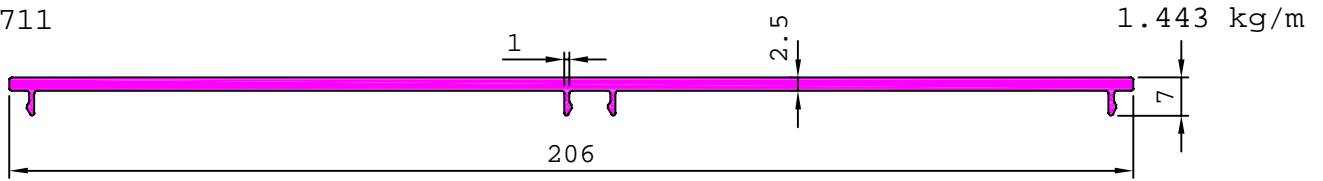

MATCHING WITH G103712,G103713

G103703

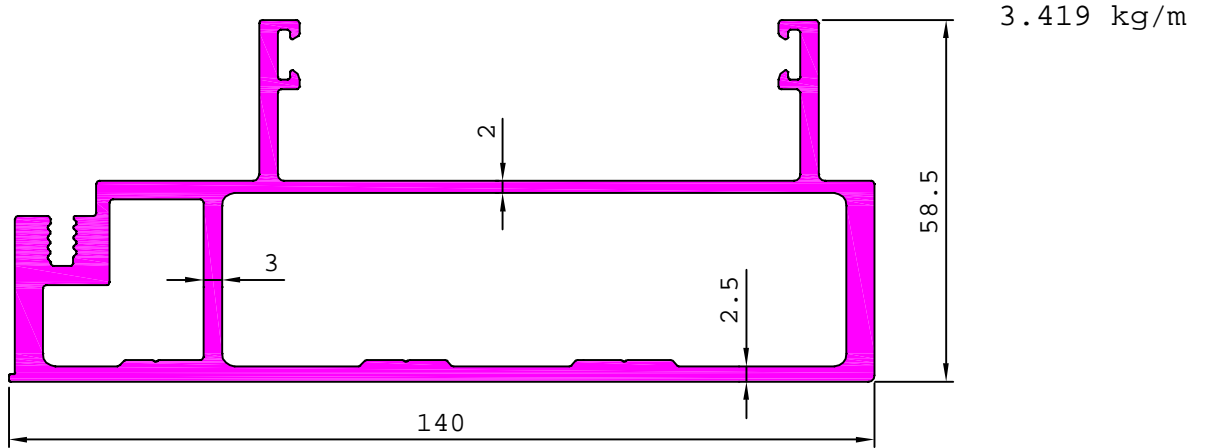

MATCHING WITH G103704

G103704

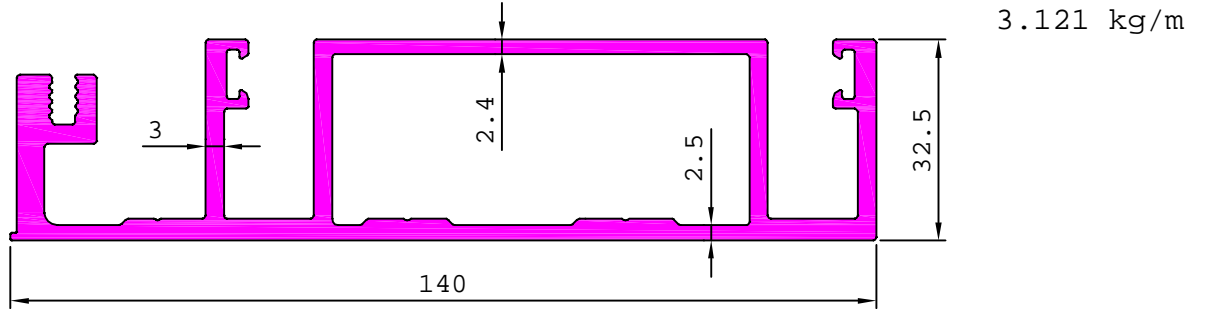

MATCHING WITH G103703

G103708

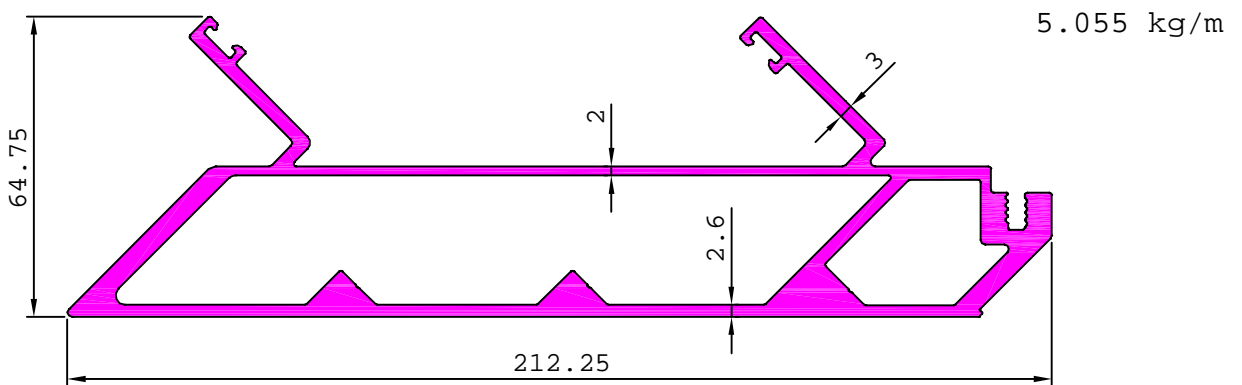

MATCHING WITH G103709

G103709

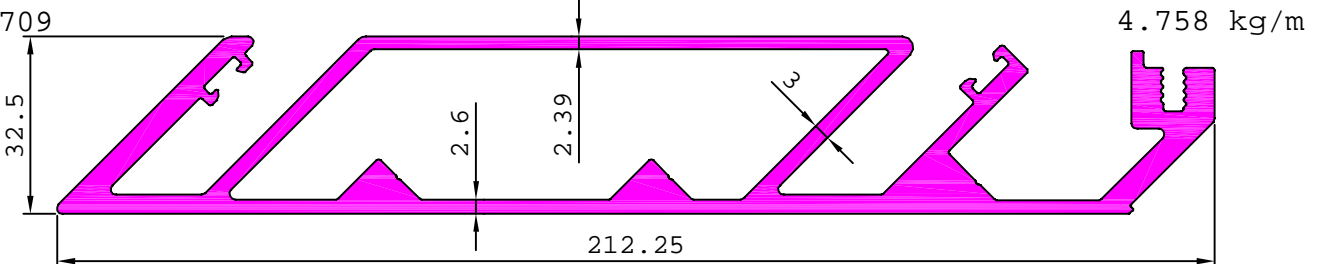

MATCHING WITH G103708

## CURTAIN WALL SECTION

G103730

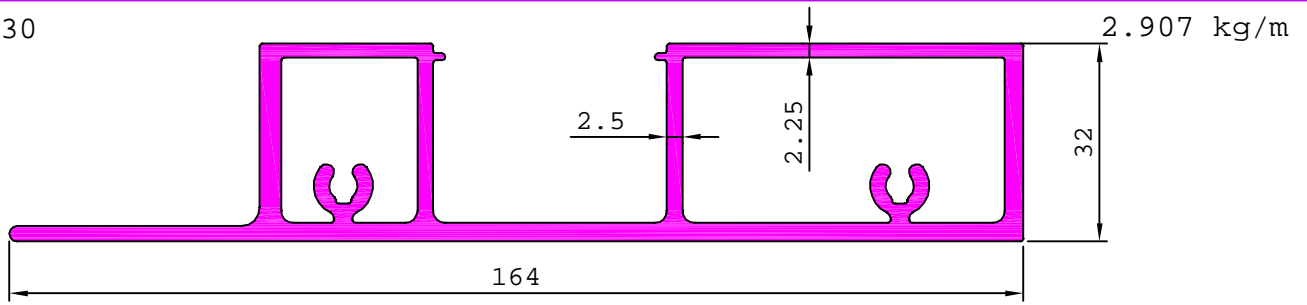

MATCHING WITH G103731

G103701

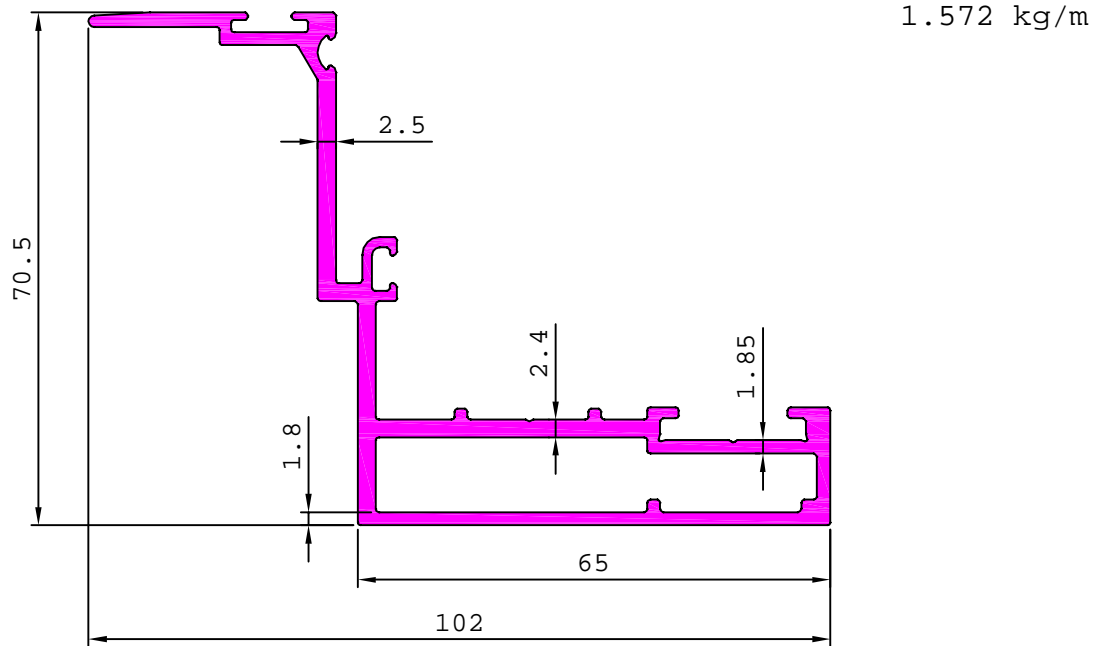

G103706

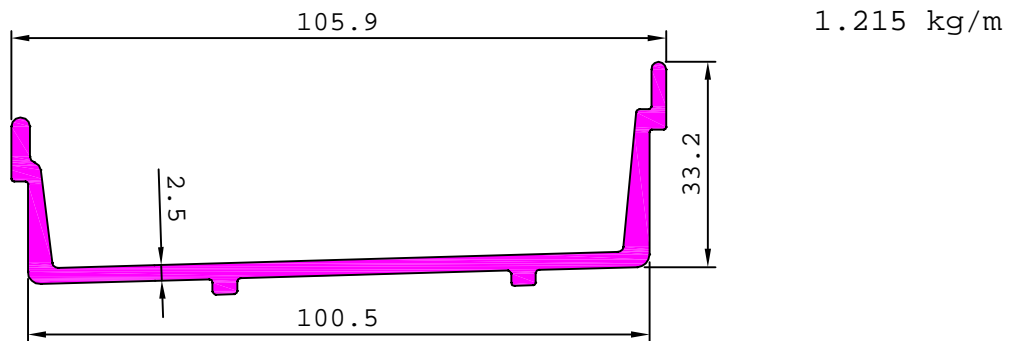

MATCHING WITH G103702

G103710

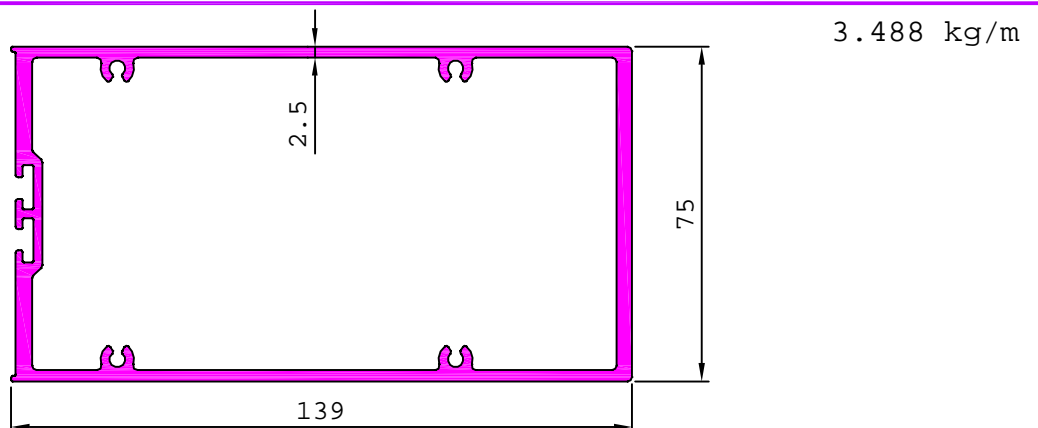

## CURTAIN WALL SECTION

G103731

0.162 kg/m

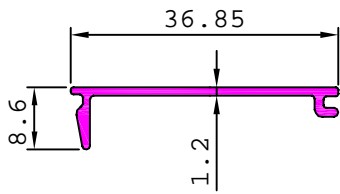

MATCHING WITH G102730

G103727

0.224 kg/m

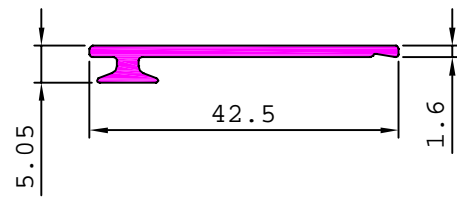

MATCHING WITH 36228

G103707

0.479 kg/m

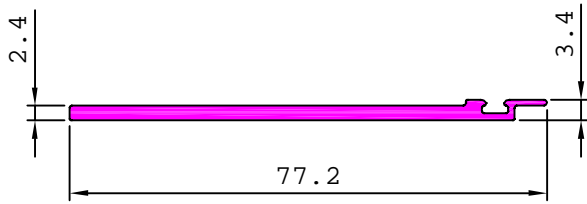

G103729

0.327 kg/m

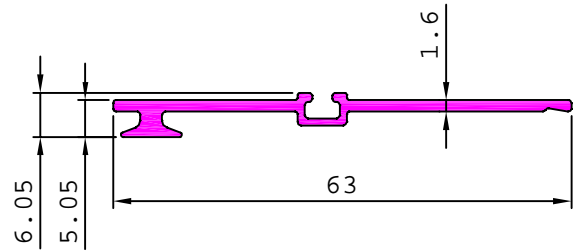

MATCHING WITH 36376,36377

G103886

6.439 kg/m

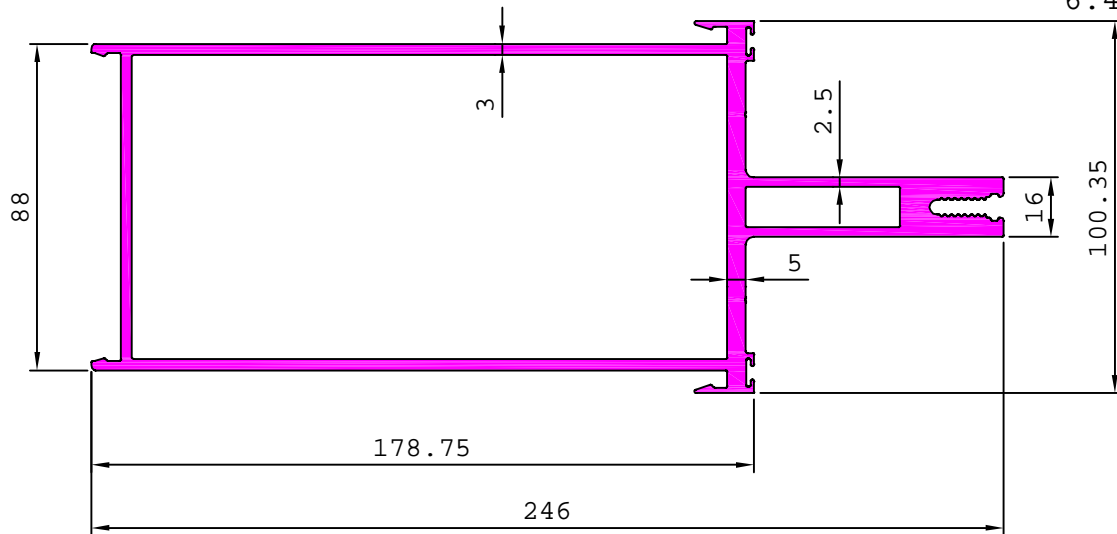

G103983

1.756 kg/m

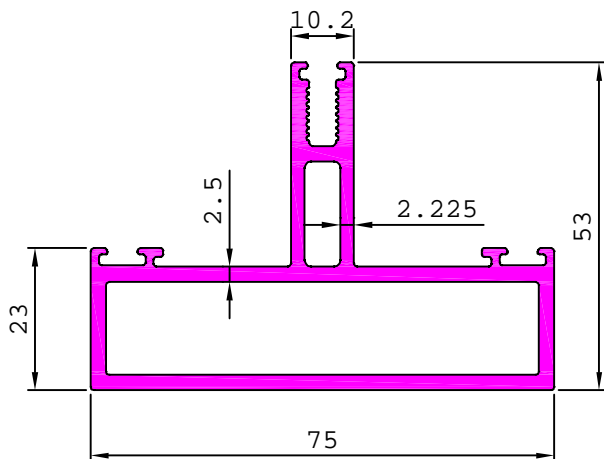

G103984

1.863 kg/m

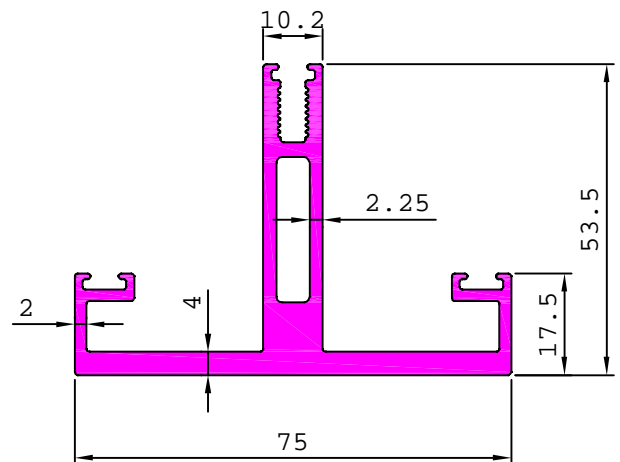

## CURTAIN WALL SECTION

G104064

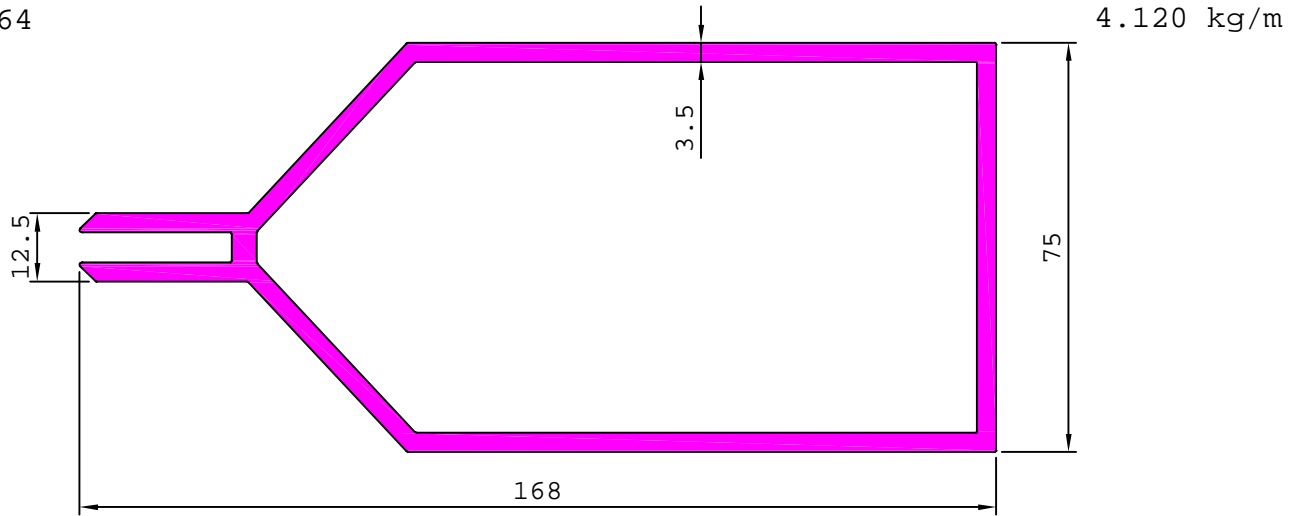

G104067

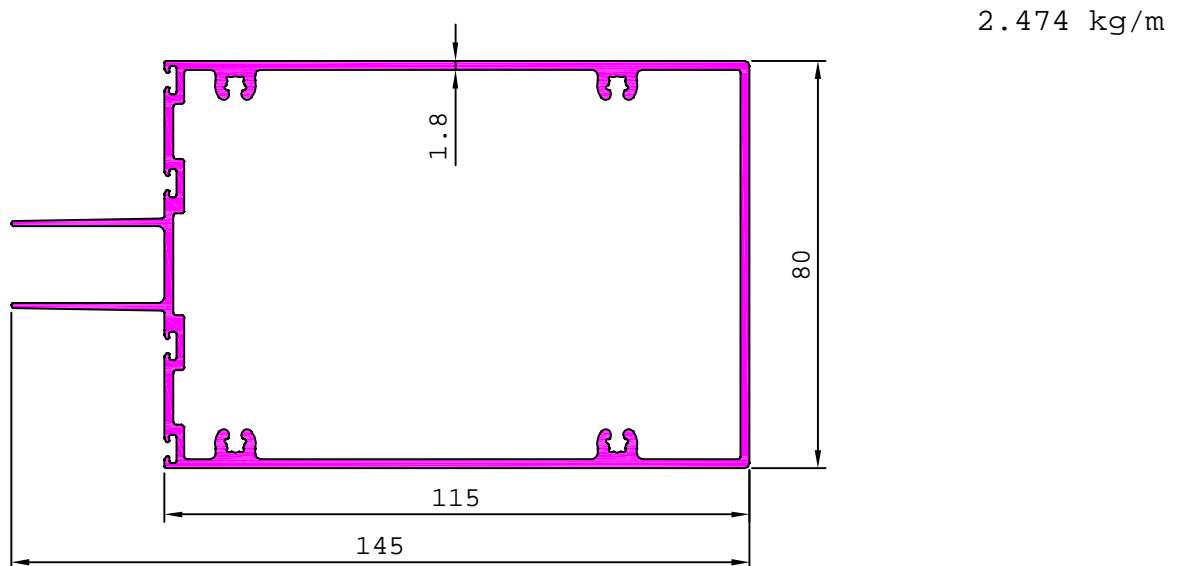

G104148

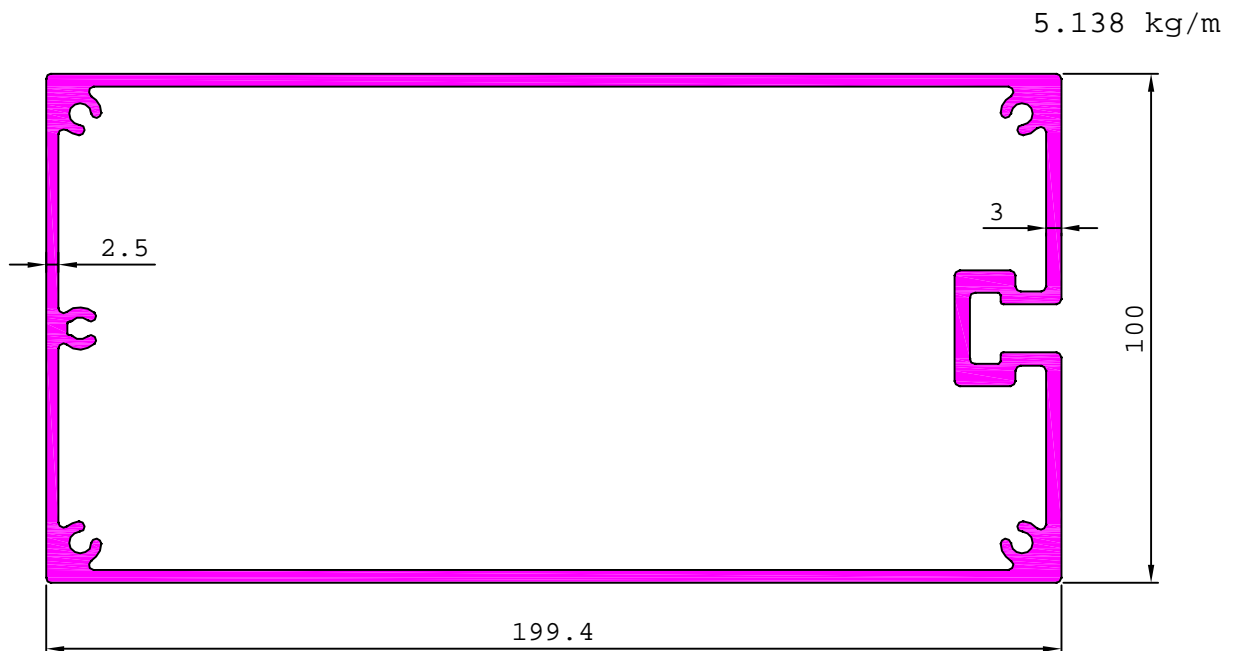

# CURTAIN WALL SECTION

G104115

3.182 kg/m

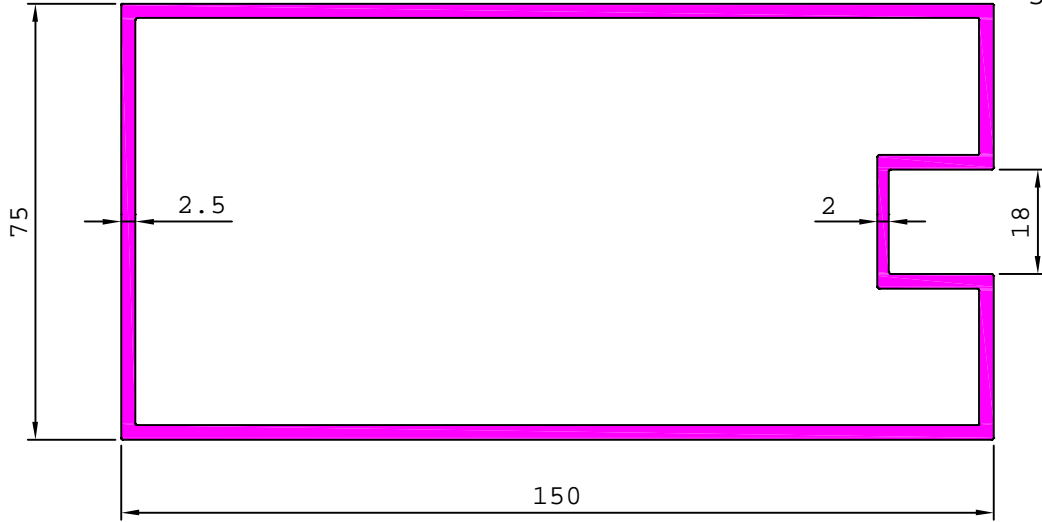

G104164

3.350 kg/m

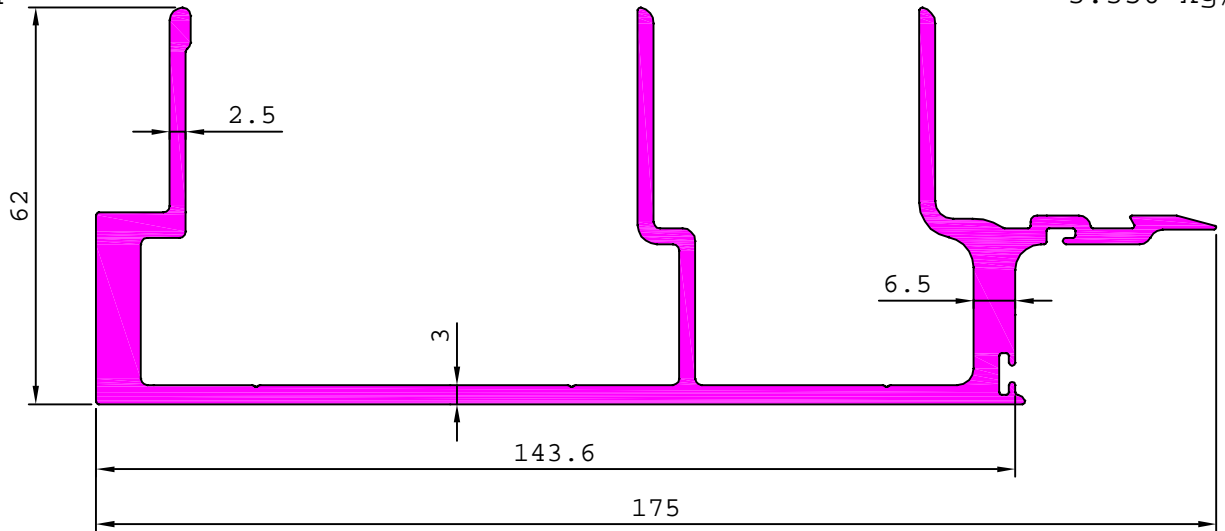

MATCHING WITH G104165

G104174

3.005 kg/m

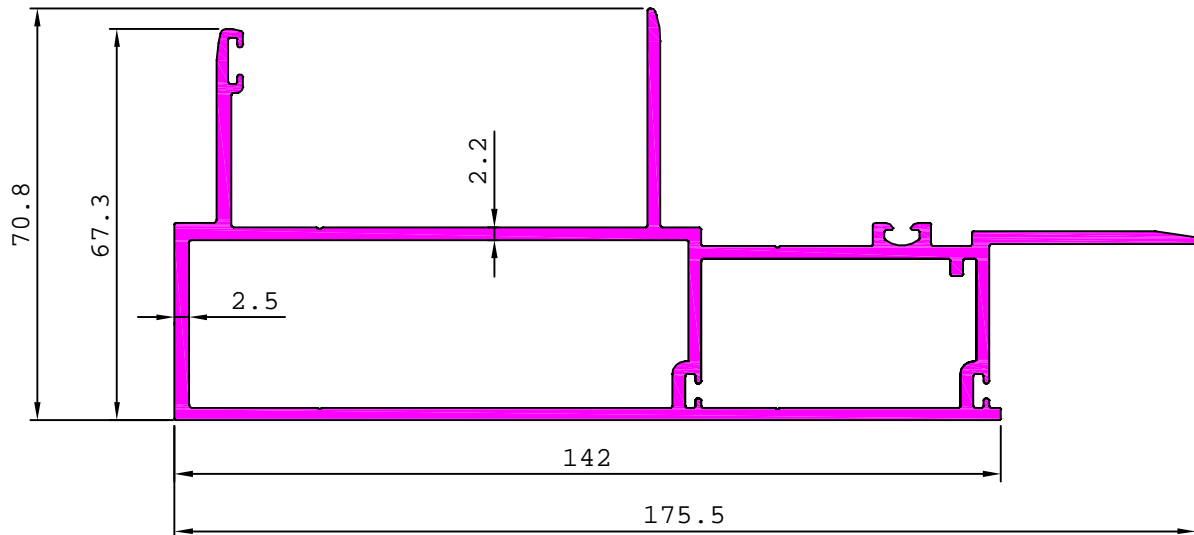

MATCHING WITH G104175

## CURTAIN WALL SECTION

G104165

2.772 kg/m

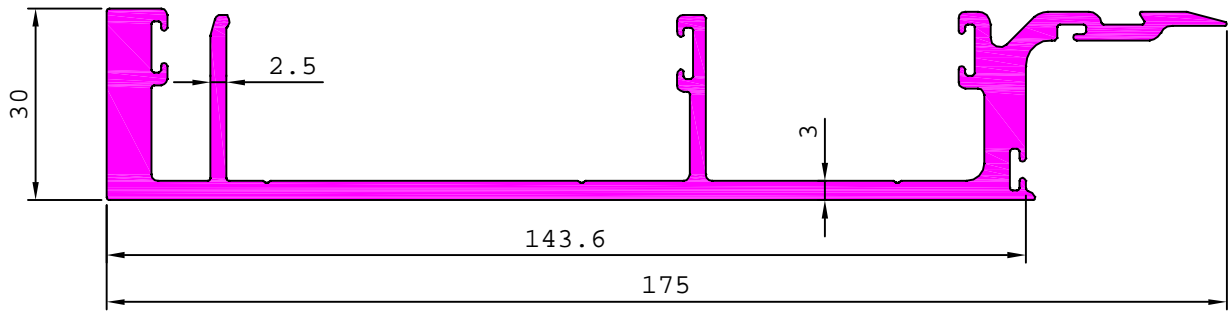

MATCHING WITH G104164

G104175

2.793 kg/m

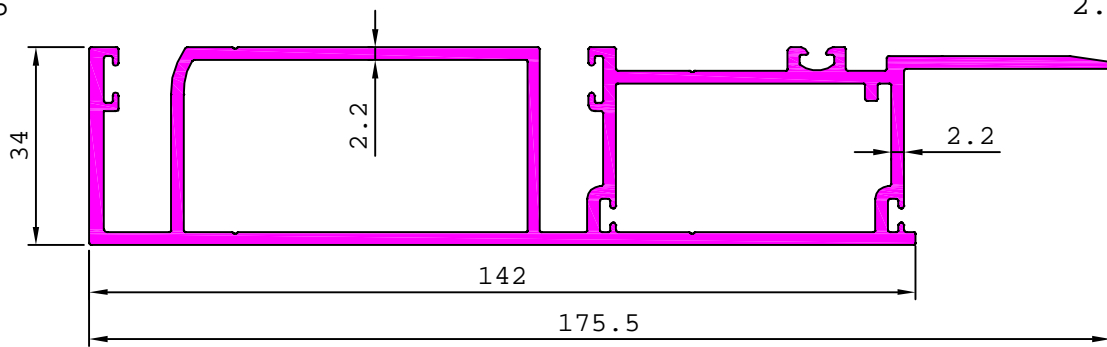

MATCHING WITH G104174

G104177

4.655 kg/m

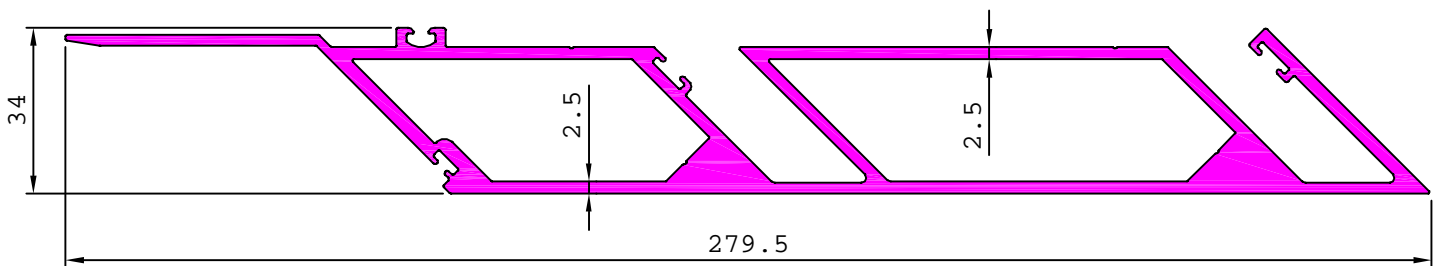

MATCHING WITH G104176

G104176

5.107 kg/m

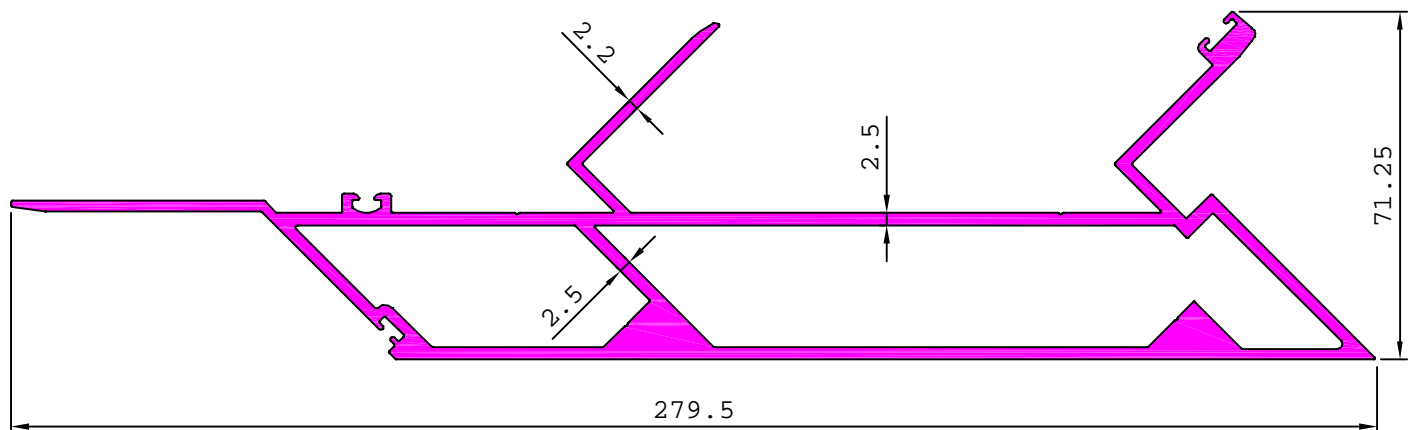

MATCHING WITH G104177

# CURTAIN WALL SECTION

G104178

6.620 kg/m

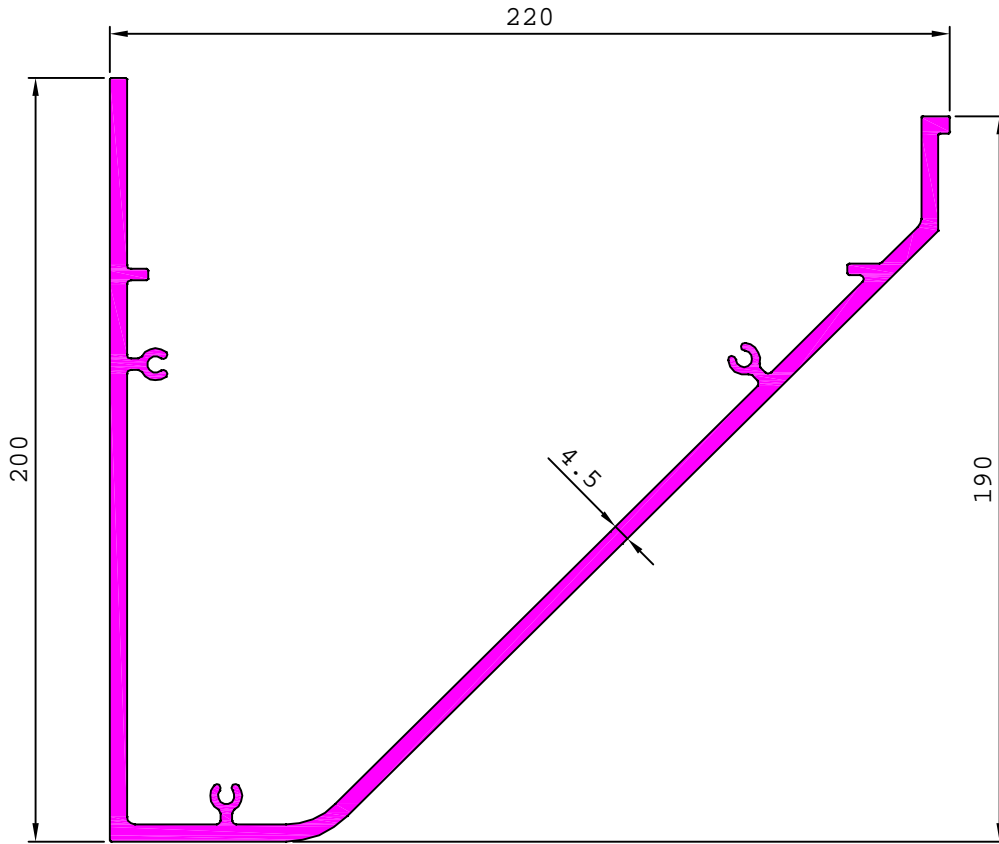

G104173

3.317 kg/m

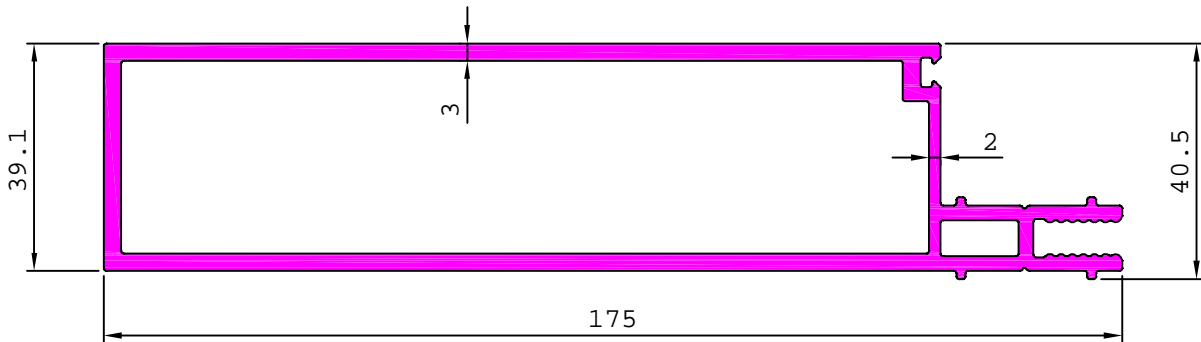

G104229

1.292 kg/m

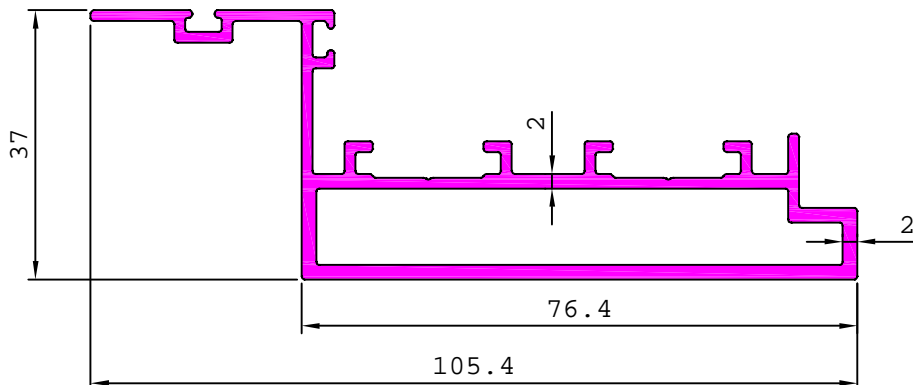

## CURTAIN WALL SECTION

G104232

2.111 kg/m

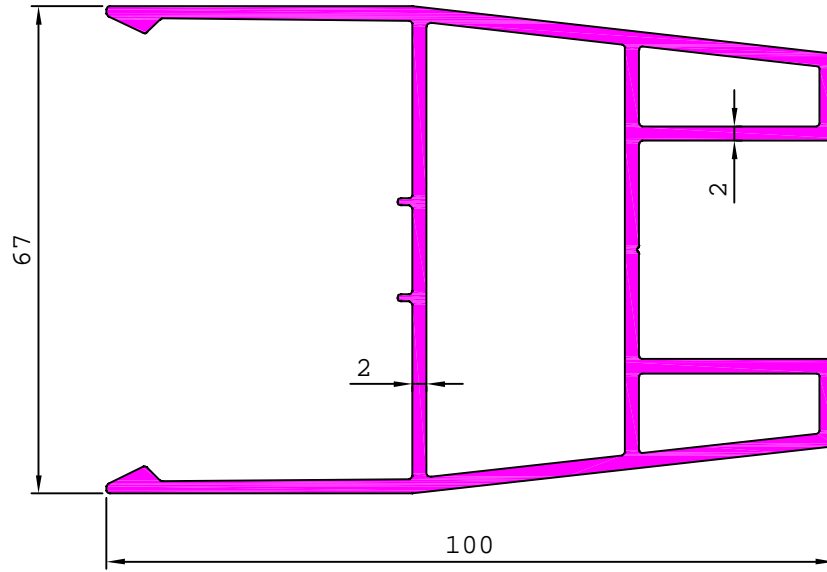

MATCHING WITH 36240

G104179

4.542 kg/m

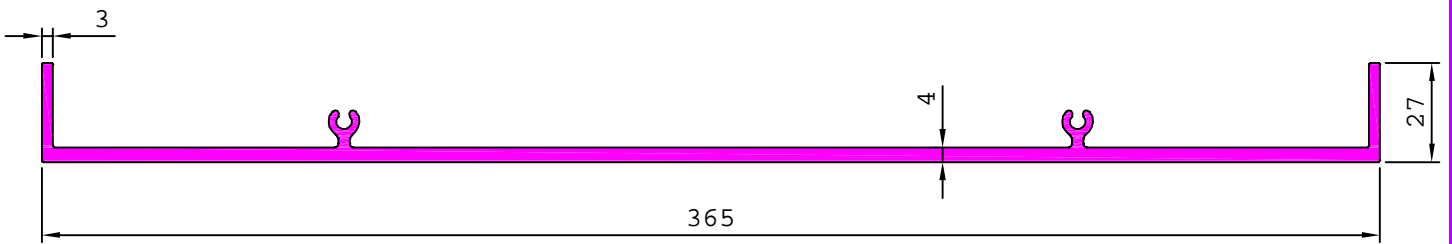

G104230

0.692 kg/m

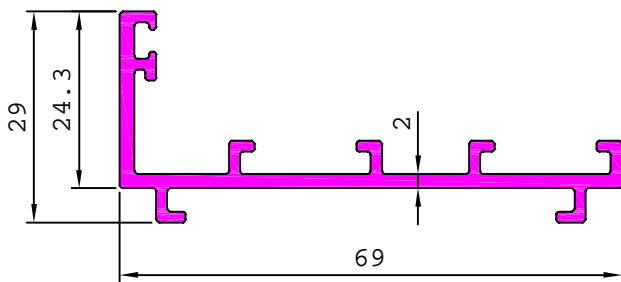

G104231

0.783 kg/m

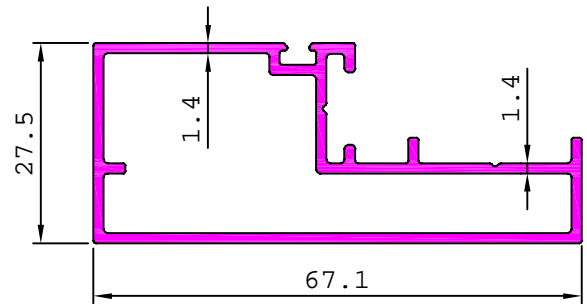

G104203

1.070 kg/m

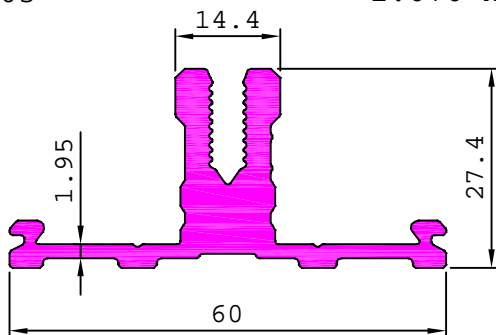

G104233

0.215 kg/m

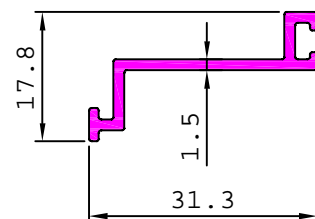

## CURTAIN WALL SECTION

G104337

0.567 kg/m

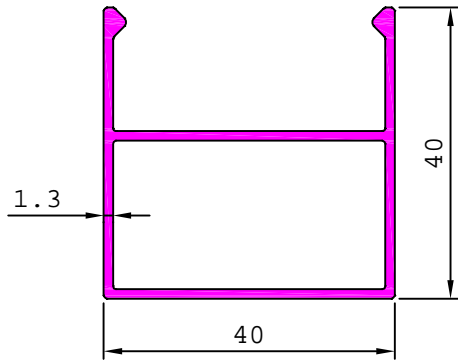

MATCHING WITH G104338

G104338

0.341 kg/m

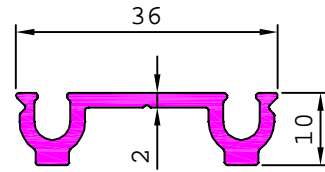

MATCHING WITH G104337

G104304

0.697 kg/m

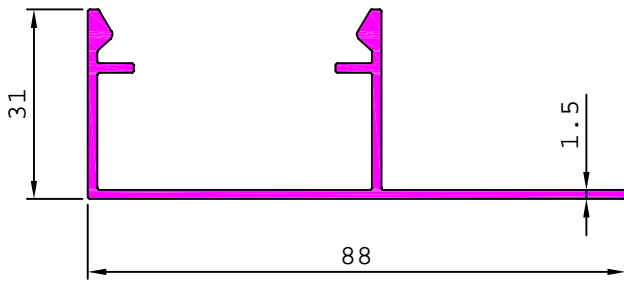

MATCHING WITH G104314

G104305

0.372 kg/m

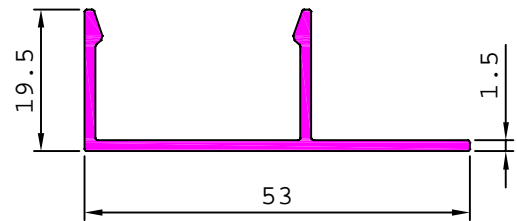

MATCHING WITH G104313

G104319

1.959 kg/m

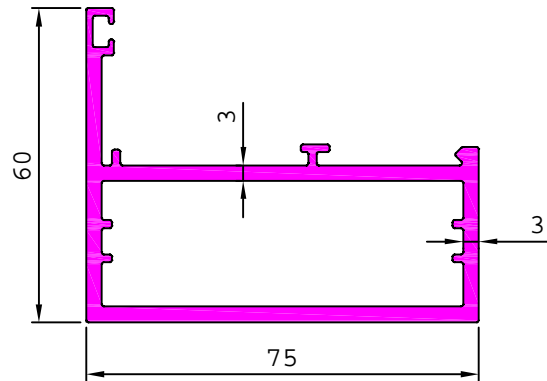

MATCHING WITH G104320

G104308

0.669 kg/m

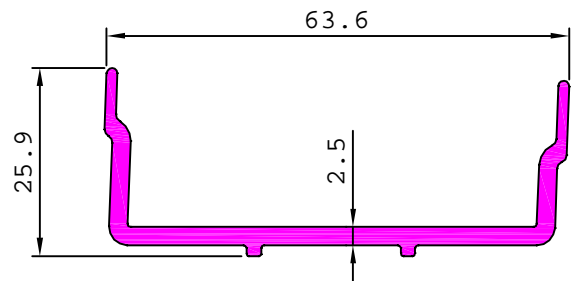

MATCHING WITH G104309

G104317

4.188 kg/m

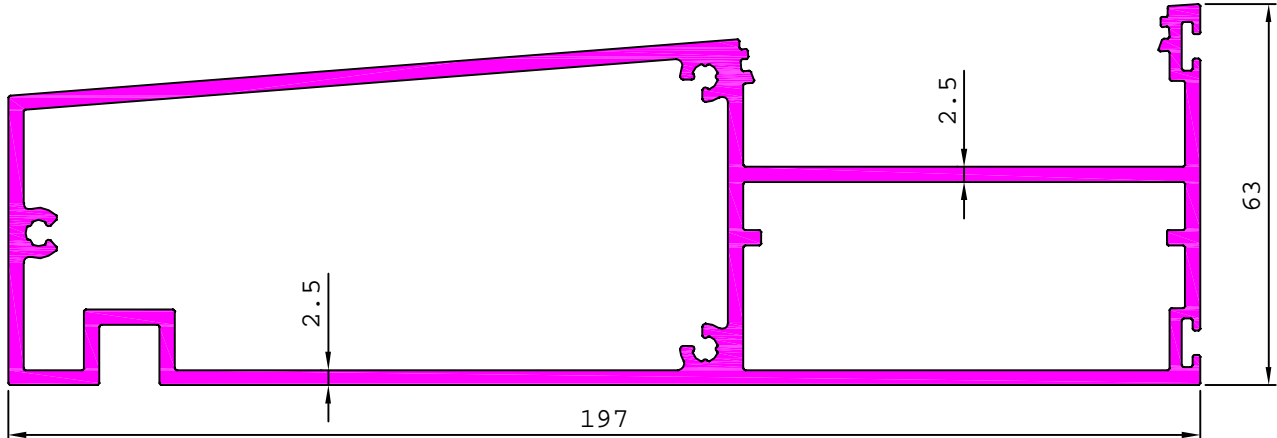

MATCHING WITH G104218

# CURTAIN WALL SECTION

G104365

2.162 kg/m

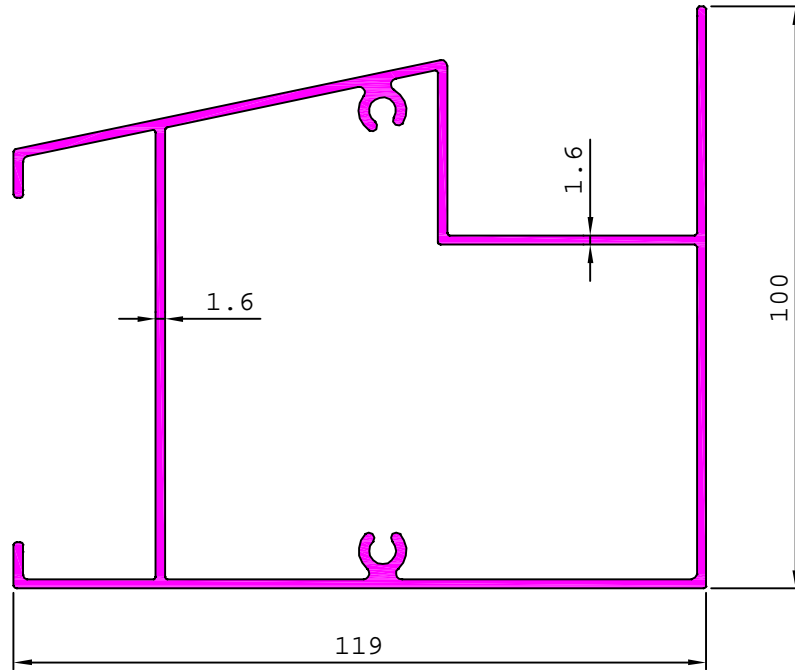

MATCHING WITH G104364

G104366

2.223 kg/m

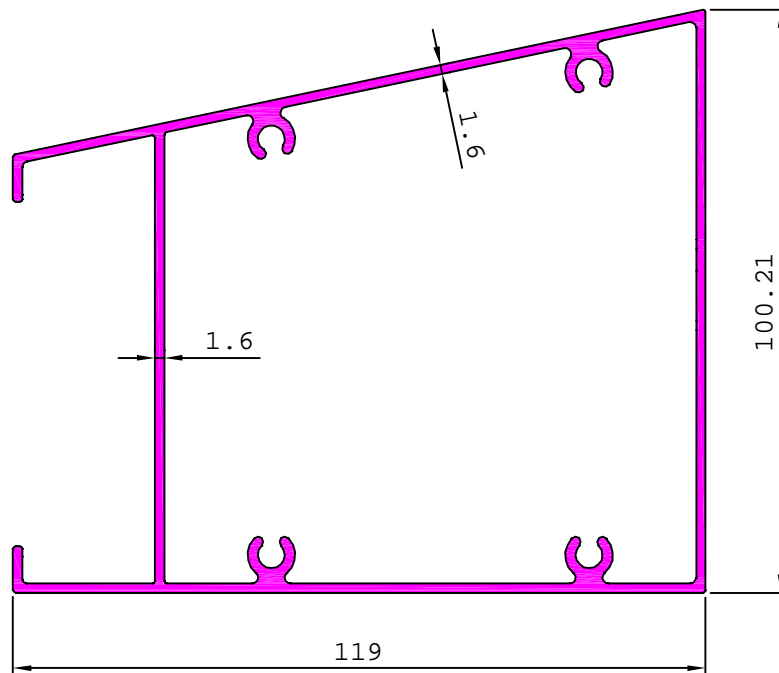

MATCHING WITH G104364

G104306

0.633 kg/m

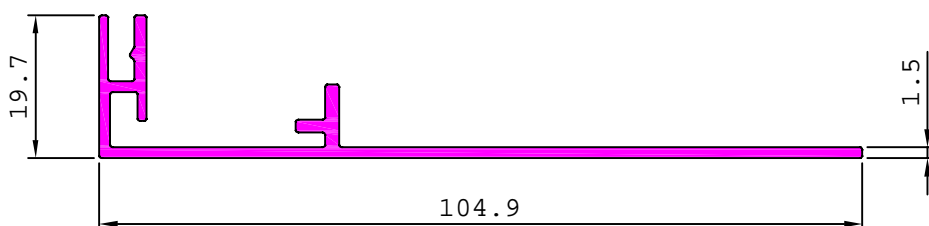

MATCHING WITH G104315

## CURTAIN WALL SECTION

G104307

1.198 kg/m

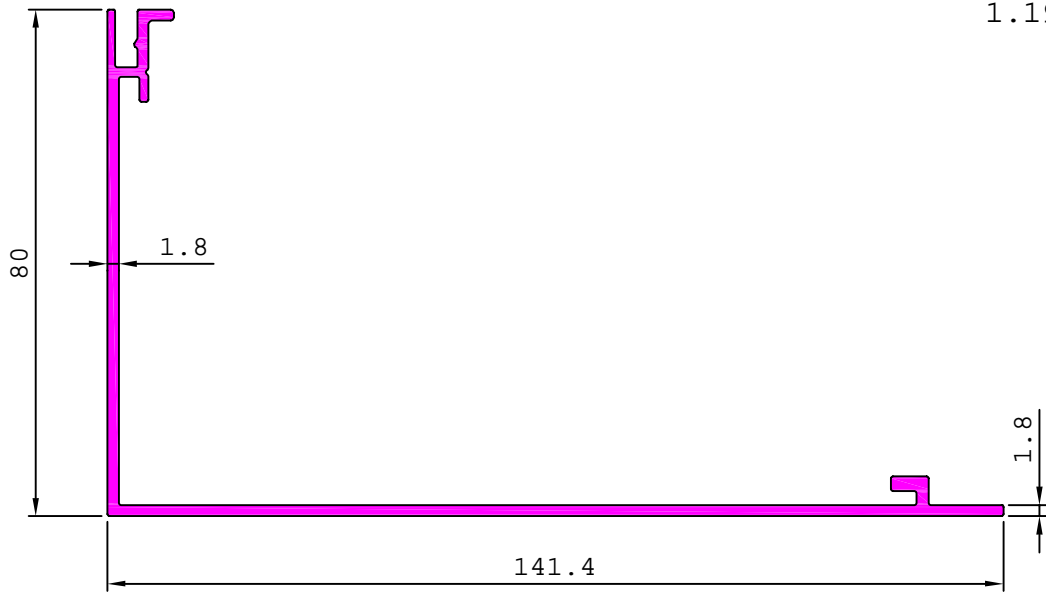

MATCHING WITH G104315

G104302

2.610 kg/m

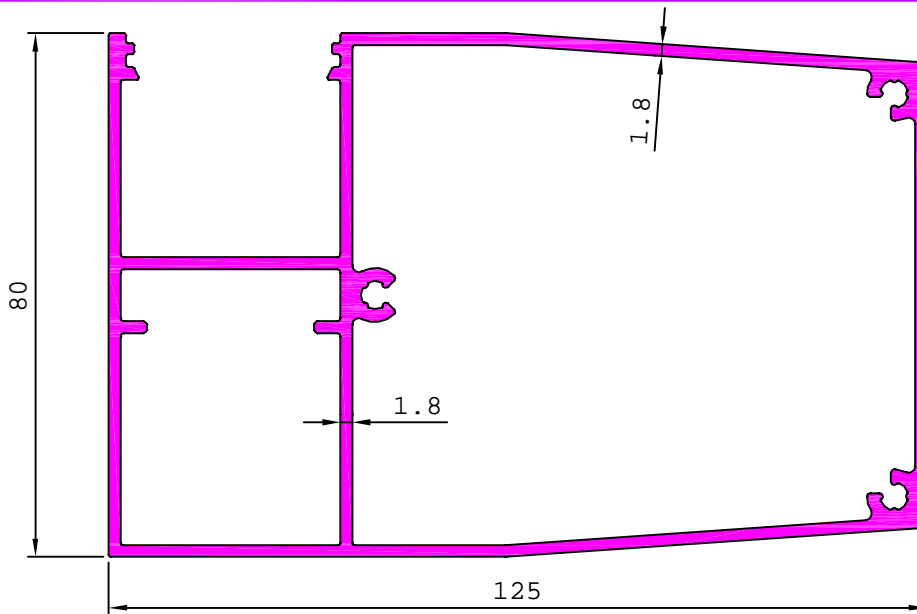

MATCHING WITH G104316

G104312

2.433 kg/m

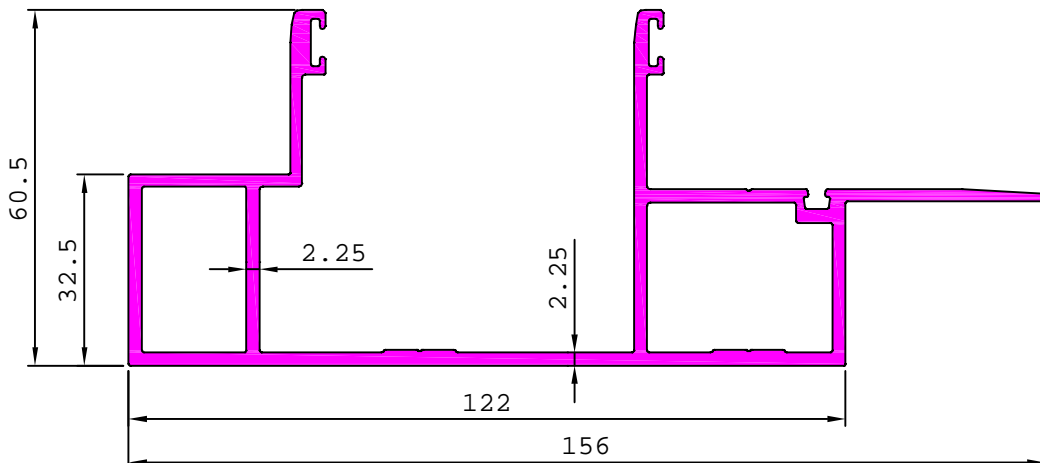

MATCHING WITH G104311

## CURTAIN WALL SECTION

G104303

4.580 kg/m

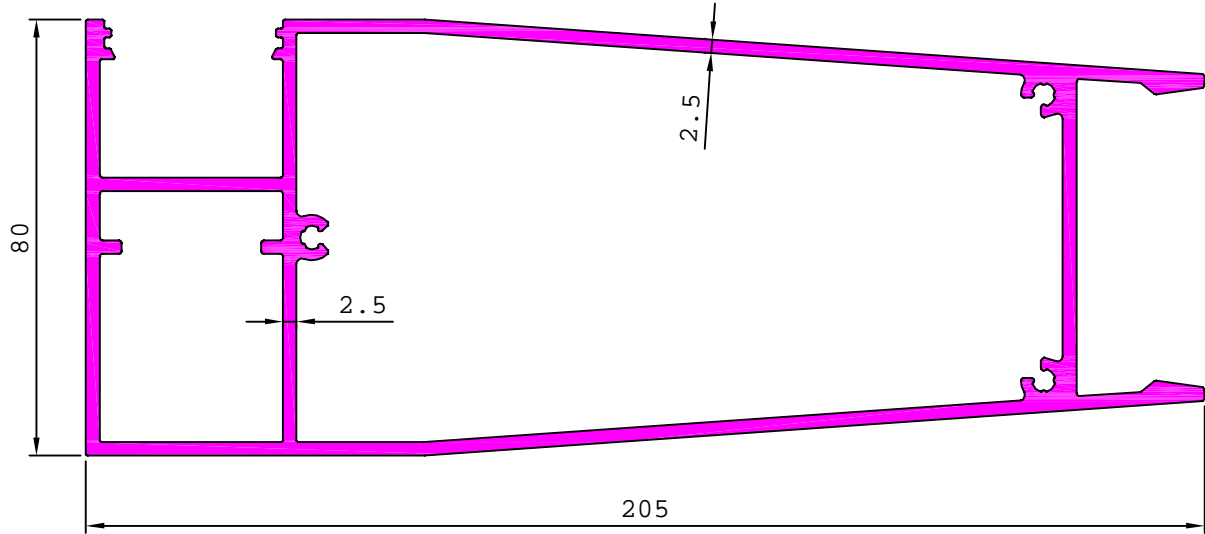

MATCHING WITH G104316

G104309

2.697 kg/m

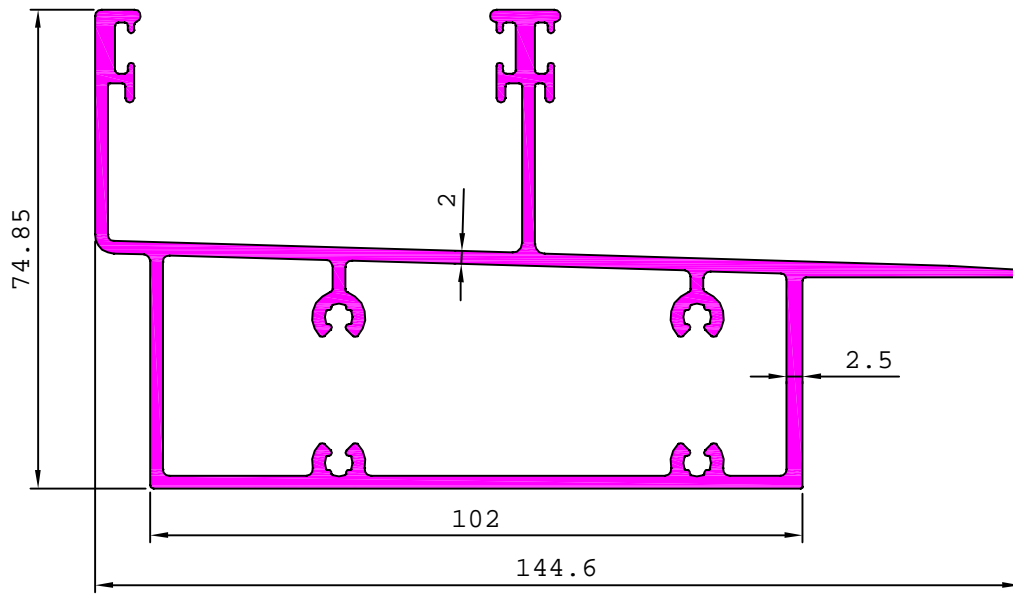

MATCHING WITH G104308

G104315

2.292 kg/m

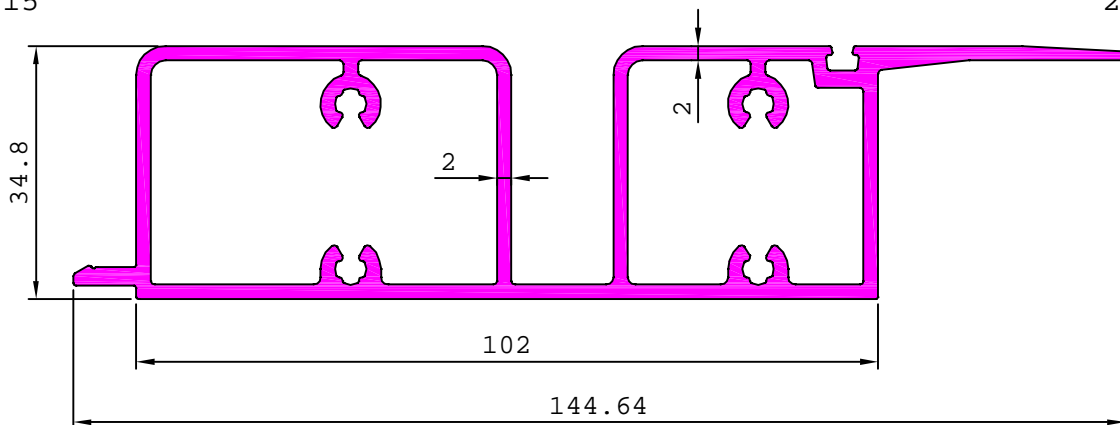

MATCHING WITH G104306,G104307

## CURTAIN WALL SECTION

G104310

2.854 kg/m

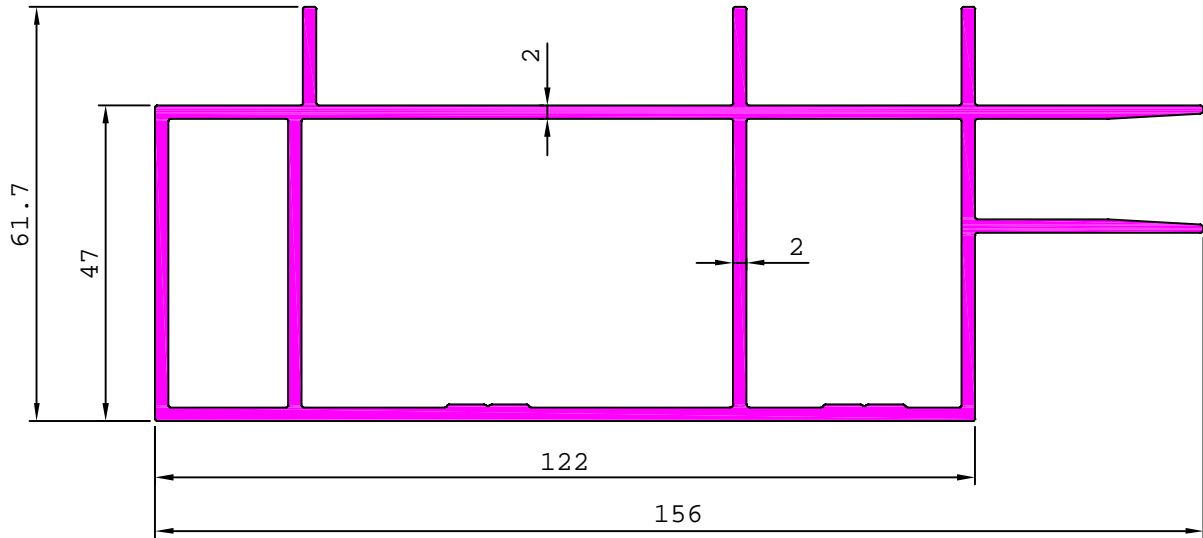

G104313

2.655 kg/m

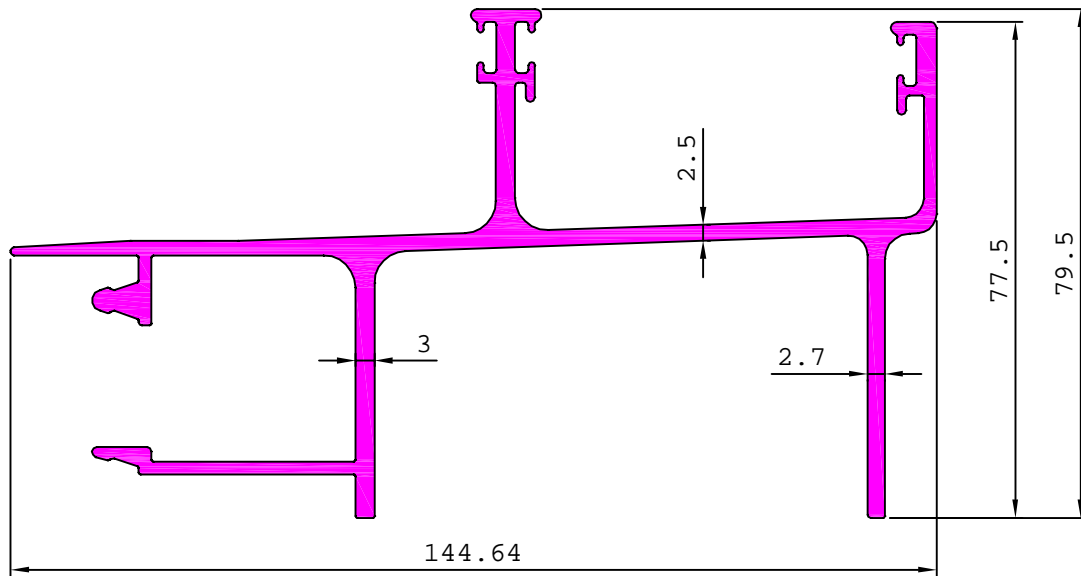

MATCHING WITH G104305

G104314

1.929 kg/m

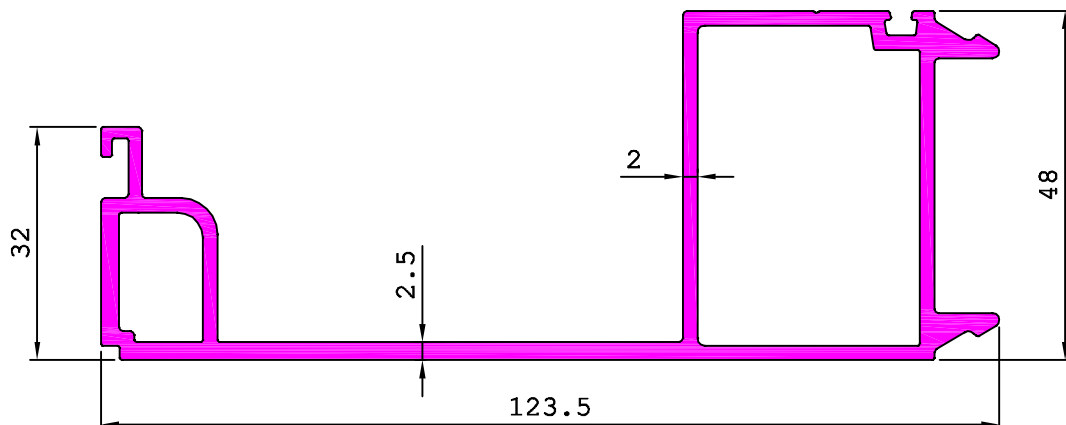

MATCHING WITH G104304

## CURTAIN WALL SECTION

G104311

2.361 kg/m

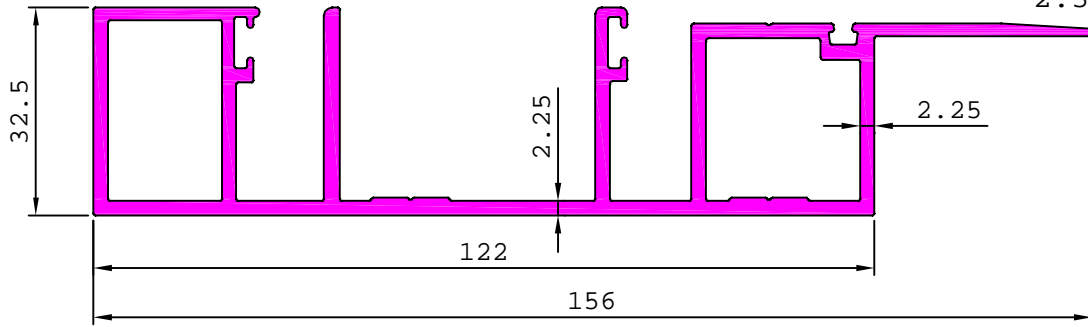

MATCHING WITH G104312

G104364

1.842 kg/m

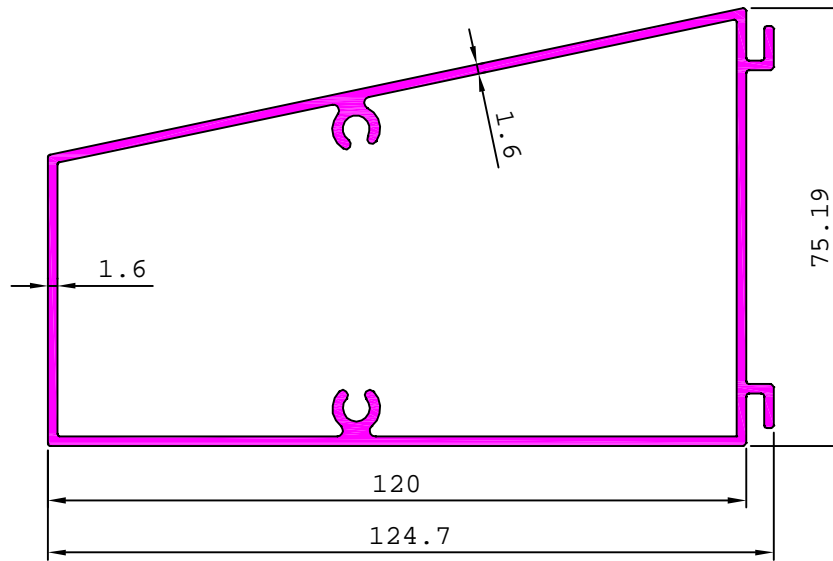

MATCHING WITH G104365,G104366

## CURTAIN WALL SECTION

35598

0.886 kg/m

35616

0.647 kg/m

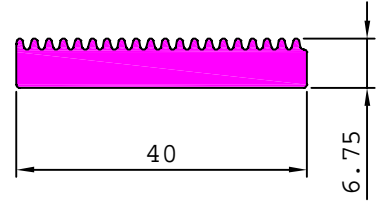
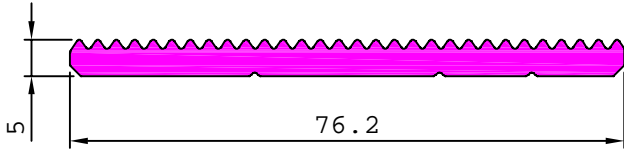

S6741

0.401 kg/m

35882

0.477 kg/m

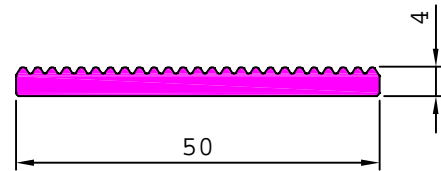
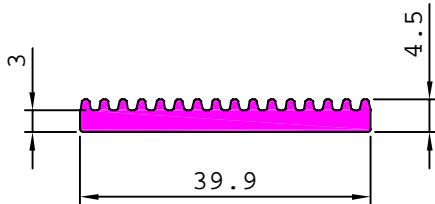

MATCHING WITH G101909,G102237

36443

10.213 kg/m

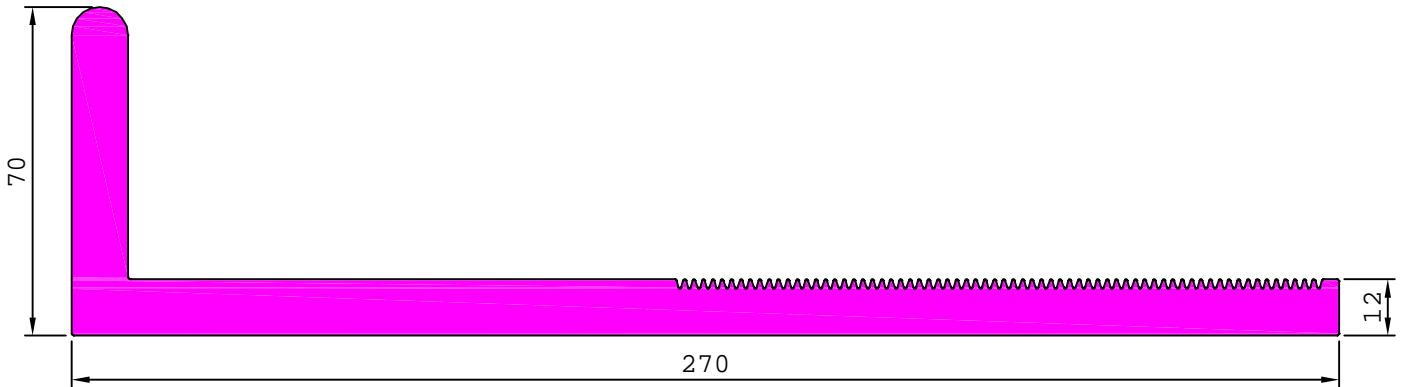

35974

9.841 kg/m

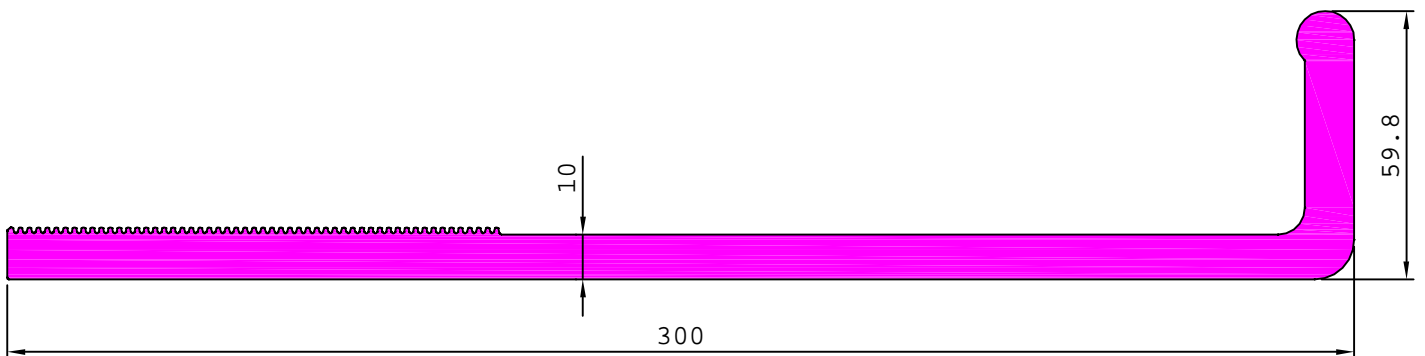

## CURTAIN WALL SECTION

29230

8.278 kg/m

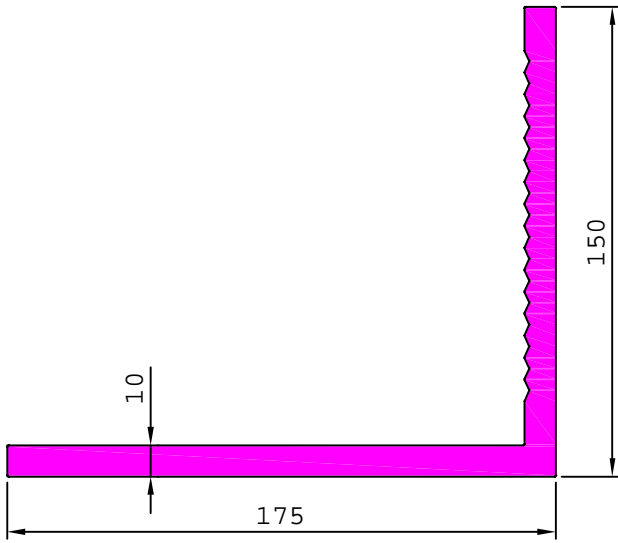

35821

1.201 kg/m

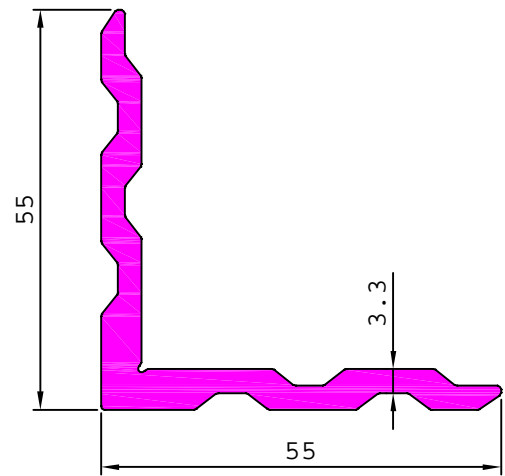

35606

3.942 kg/m

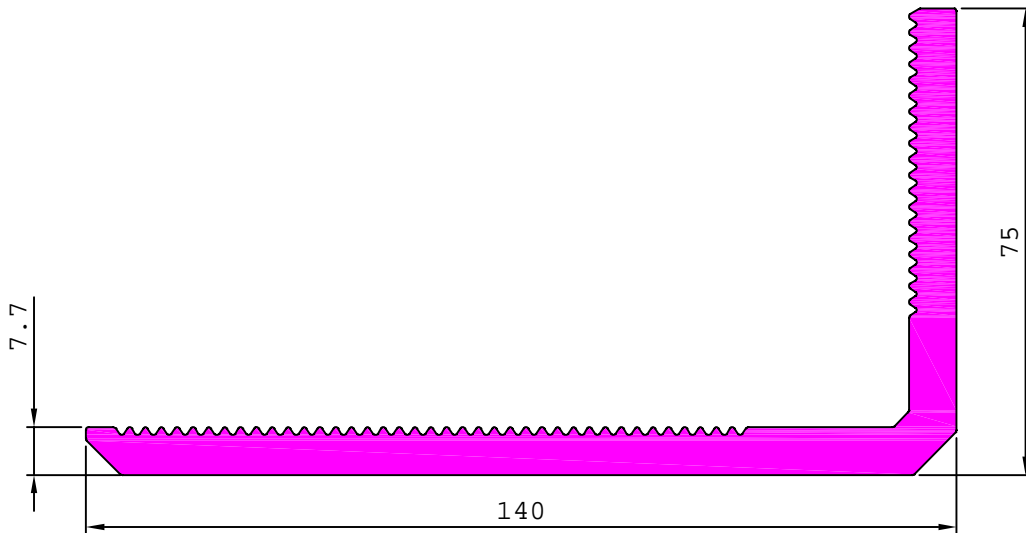

35614

4.284 kg/m

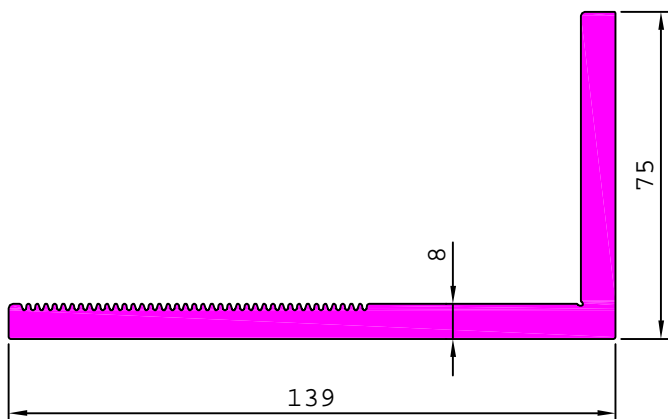

22912

2.504 kg/m

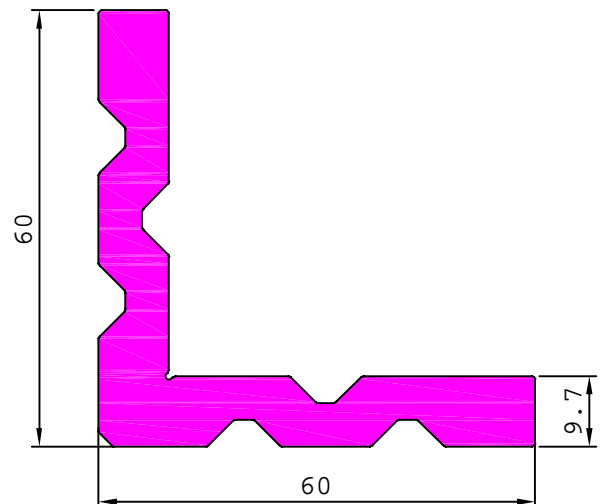

# CURTAIN WALL SECTION

27995

24.039 kg/m

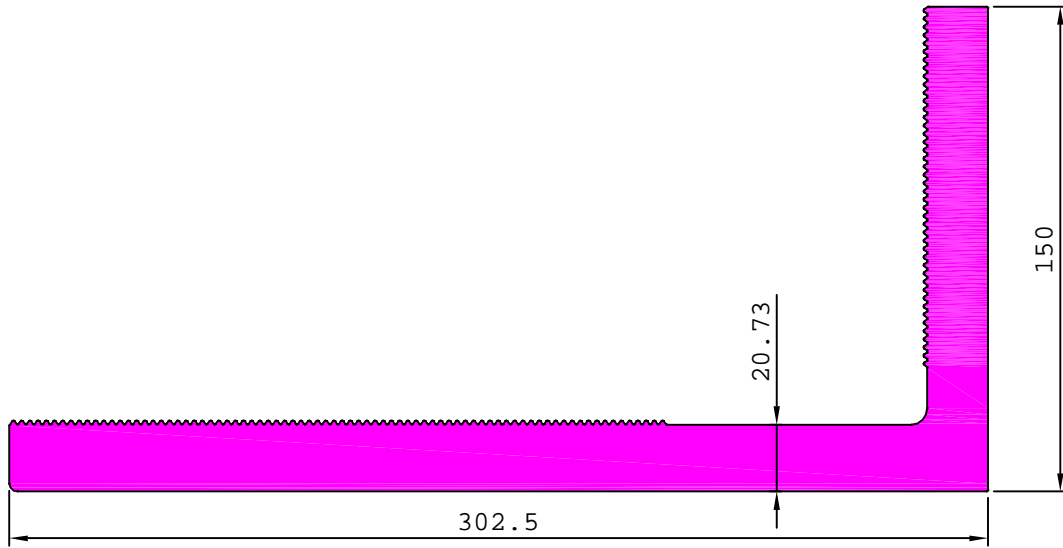

35864

18.108 kg/m

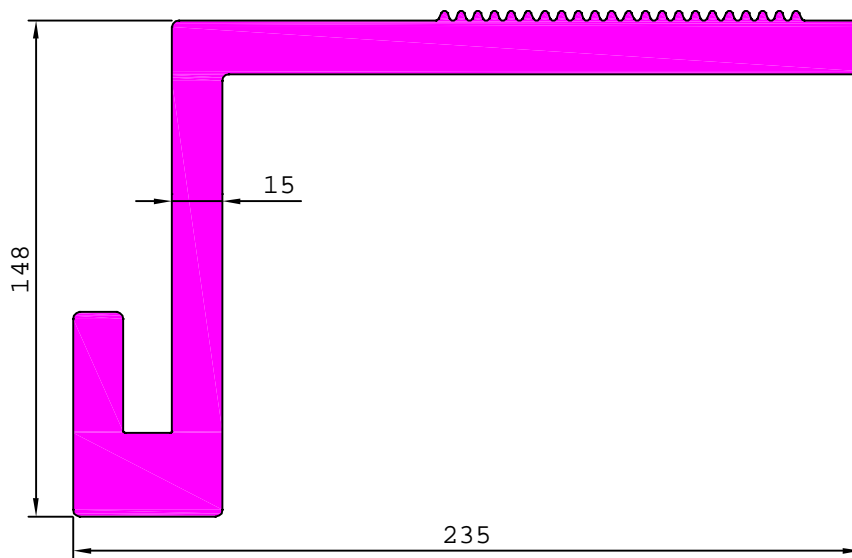

35866

12.957 kg/m

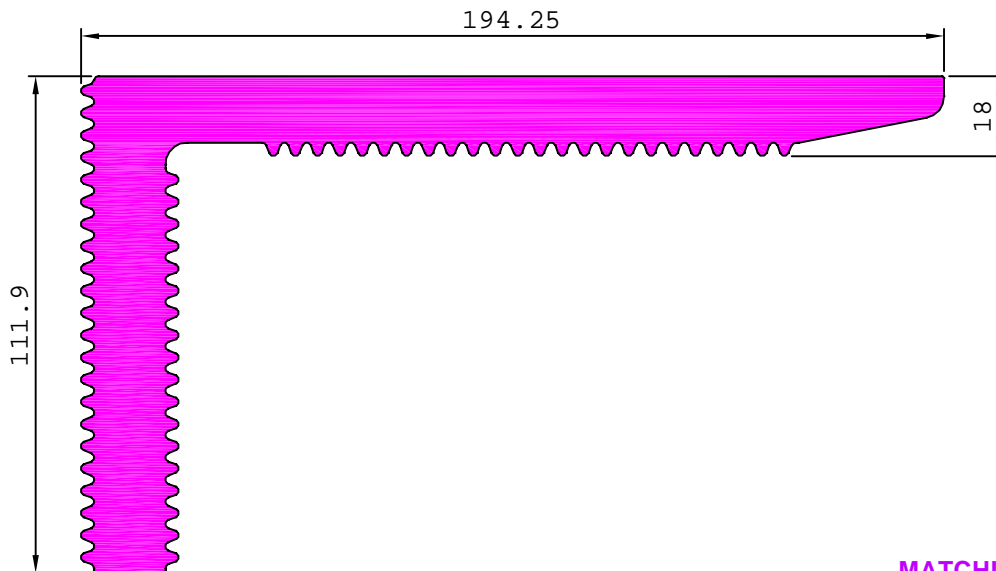

MATCHING WITH G103407

# CURTAIN WALL SECTION

35936

8.247 kg/m

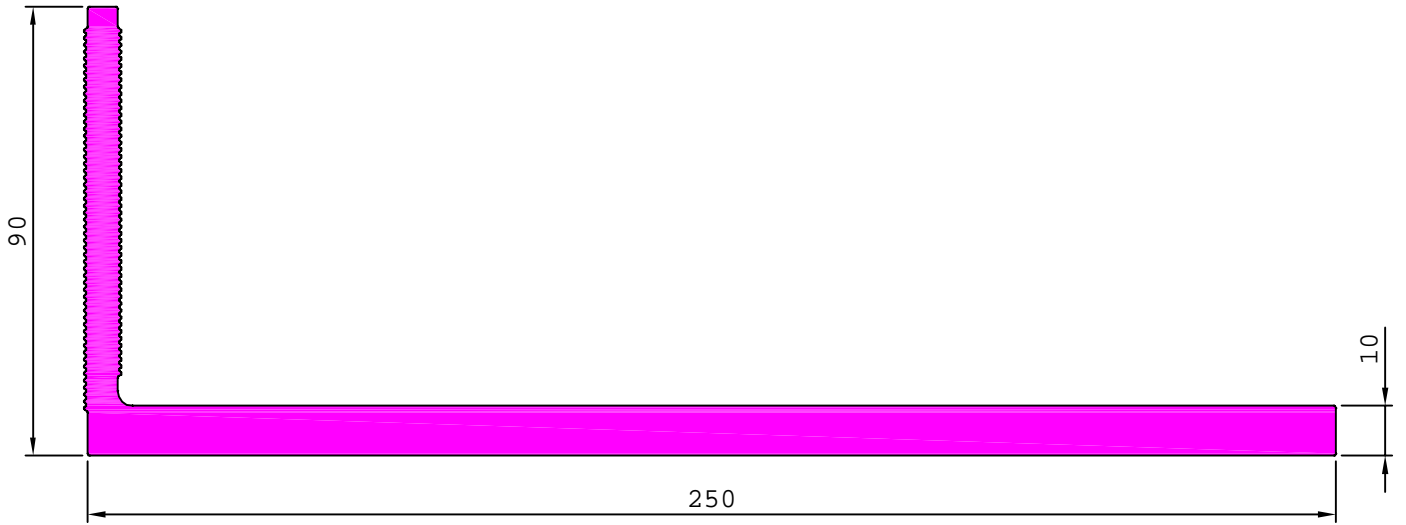

35935

5.045 kg/m

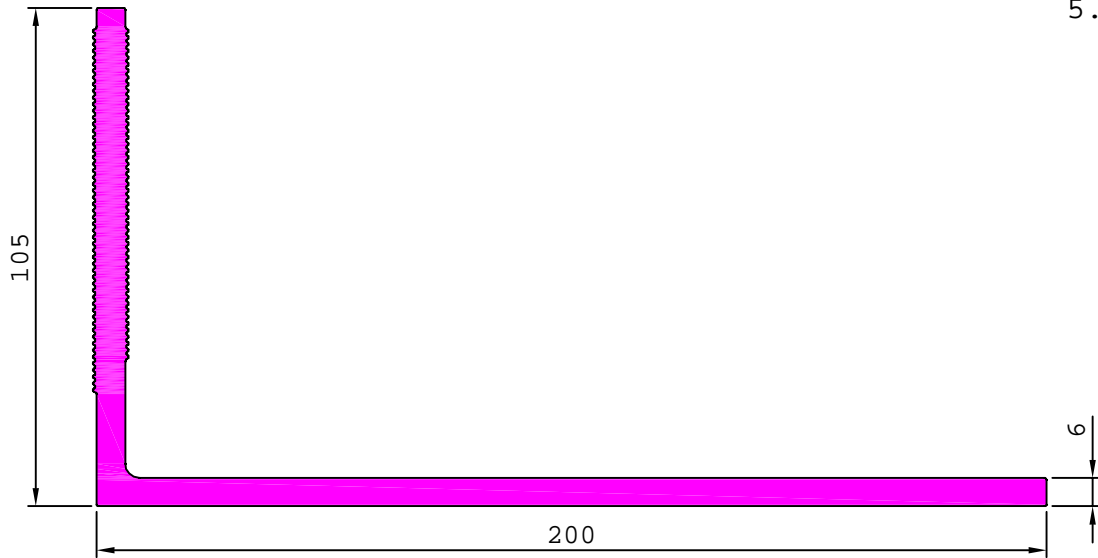

35561

19.995 kg/m

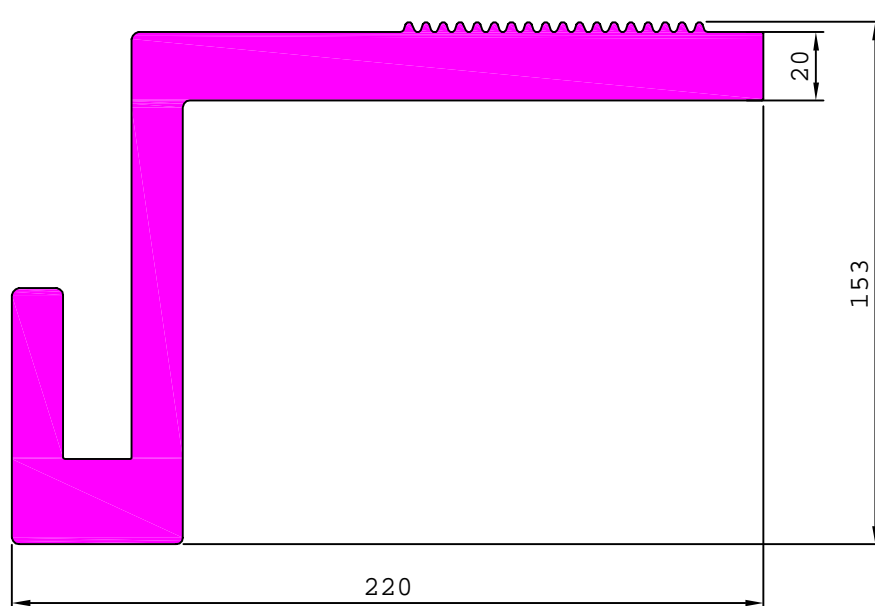

# CURTAIN WALL SECTION

36024

4.860 kg/m

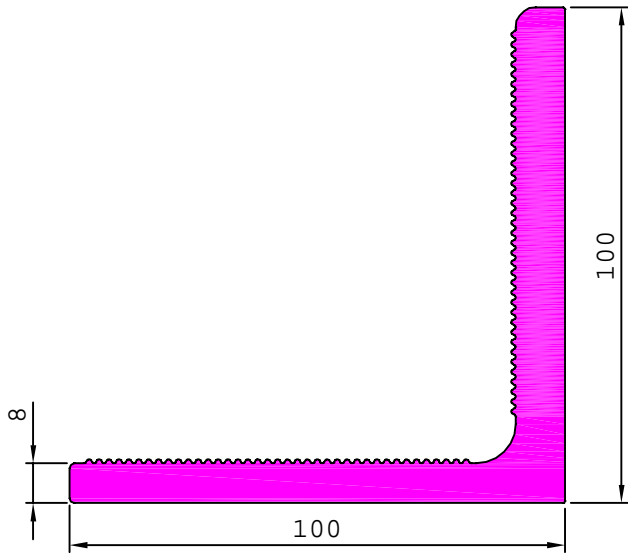

36285

5.285 kg/m

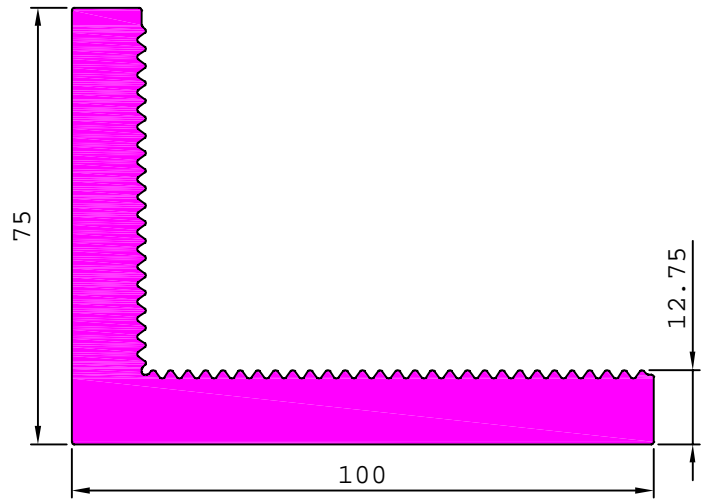

MATCHING WITH G104058

36227

19.953 kg/m

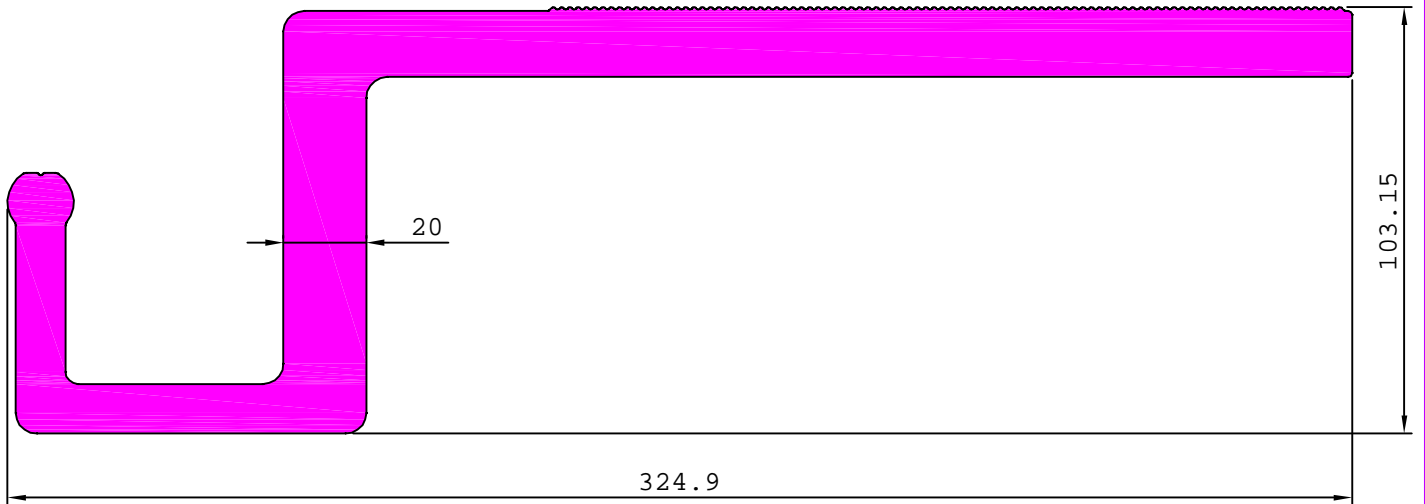

S6238

24.148 kg/m

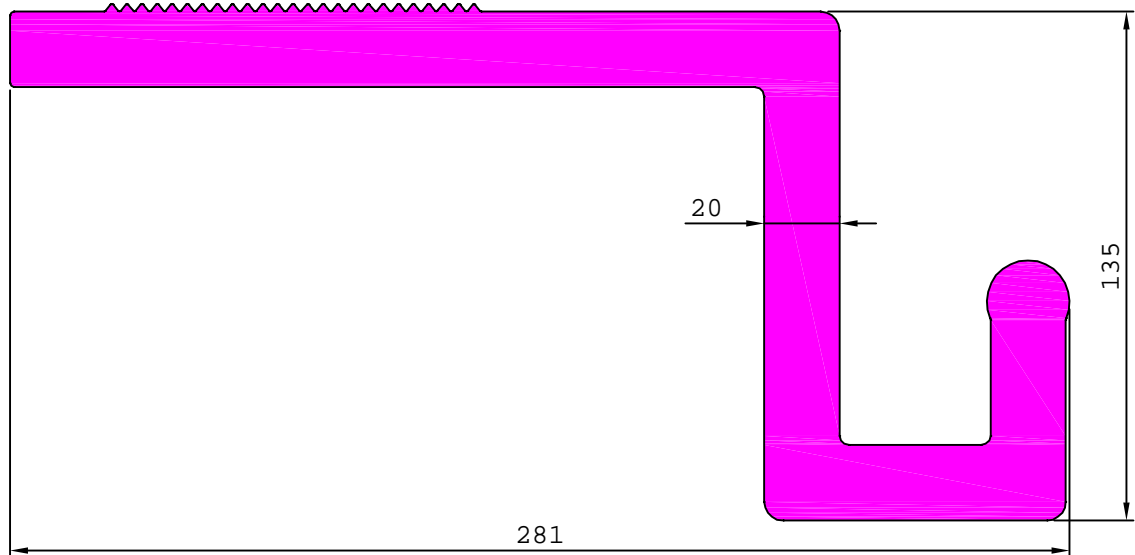

## CURTAIN WALL SECTION

36183

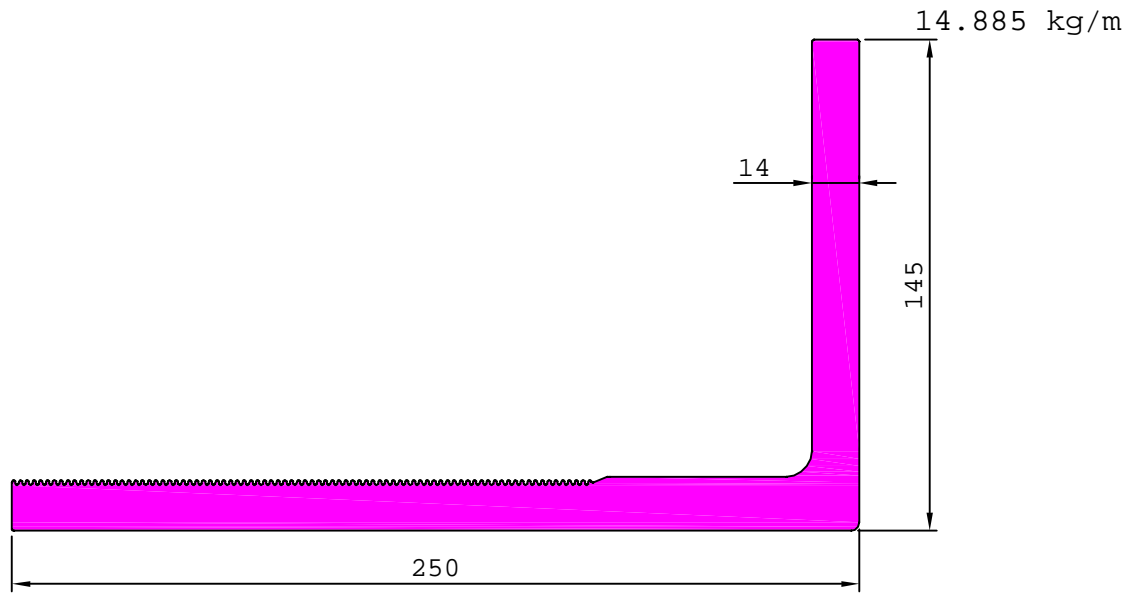

S6780

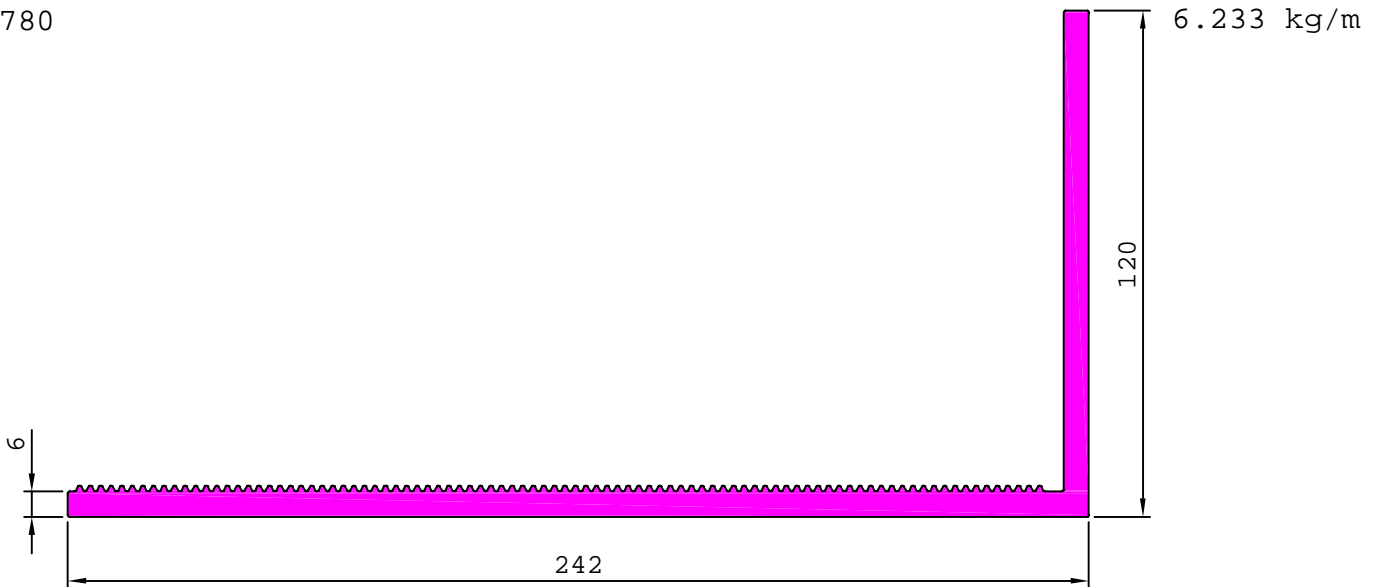

36359

8.827 kg/m

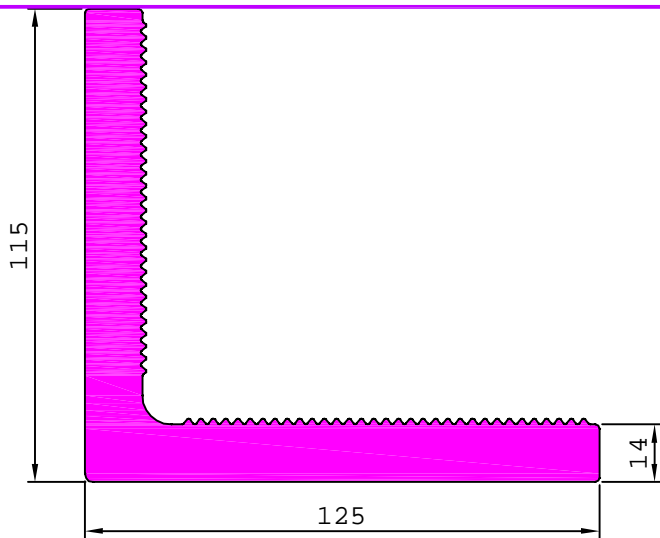

MATCHING WITH G104058

S6687

2.837 kg/m

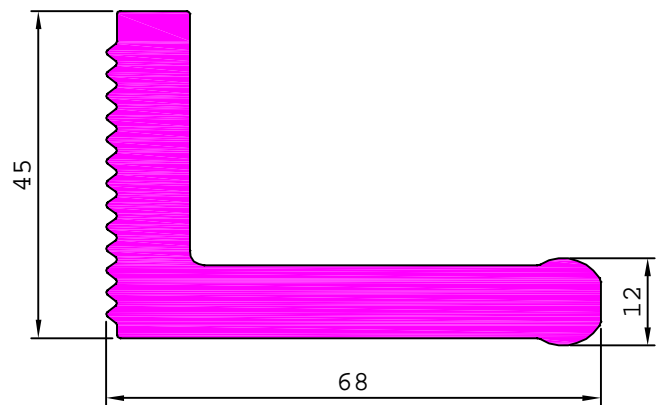

## CURTAIN WALL SECTION

36233

10.958 kg/m

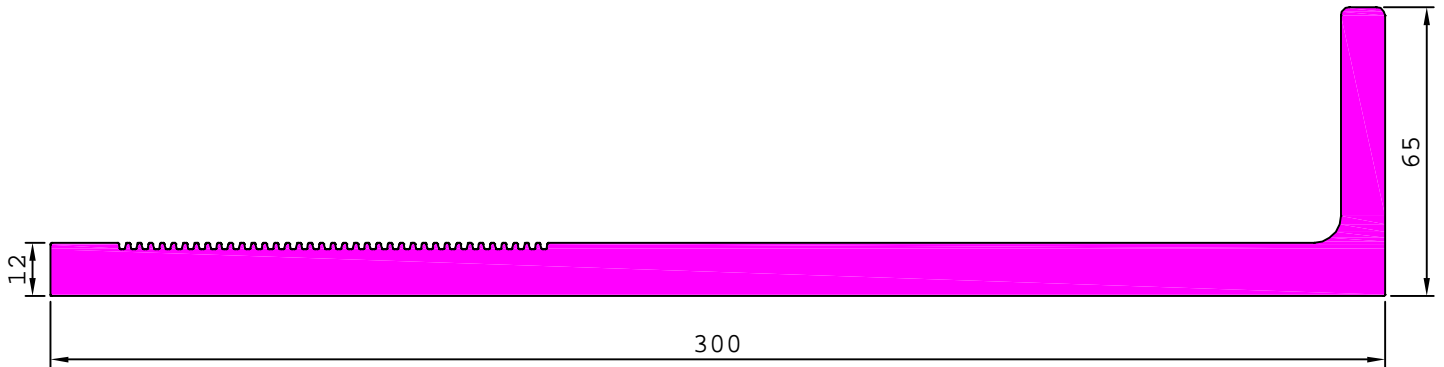

S6777

4.228 kg/m

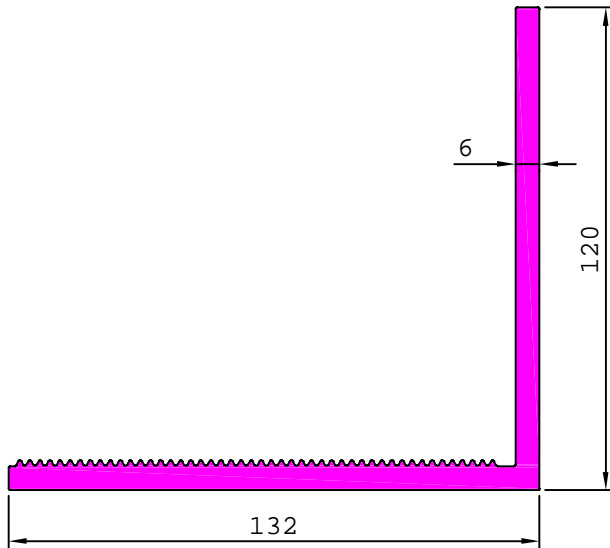

36336

7.292 kg/m

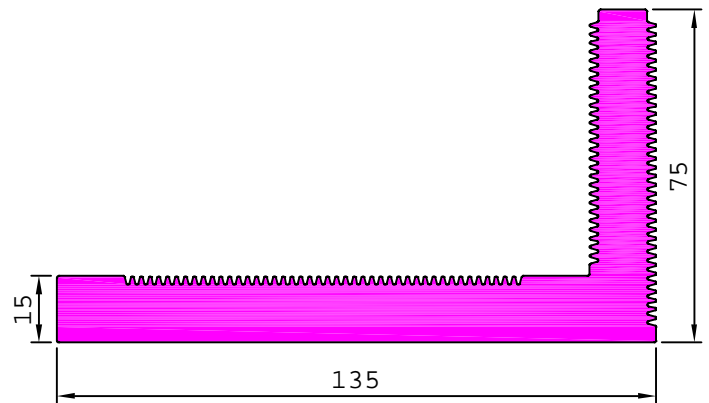

36337

9.053 kg/m

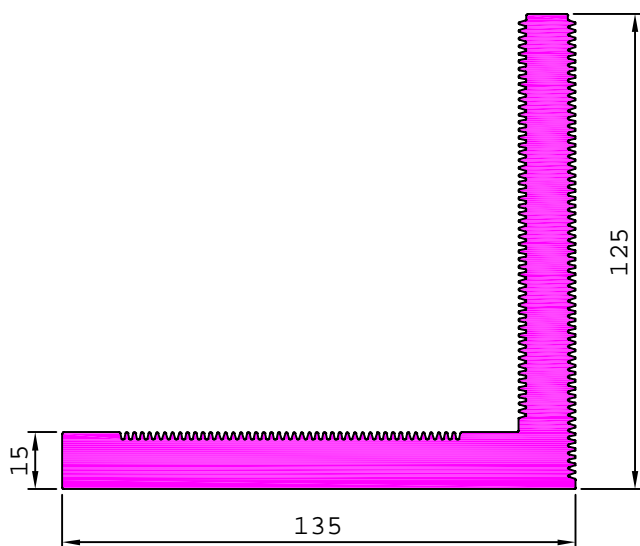

36338

3.396 kg/m

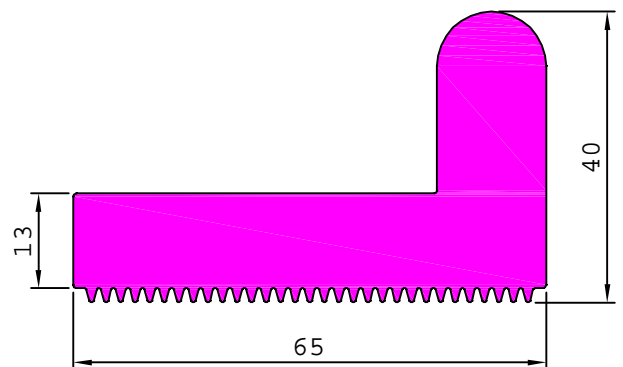

# CURTAIN WALL SECTION

G101210

21.121 kg/m

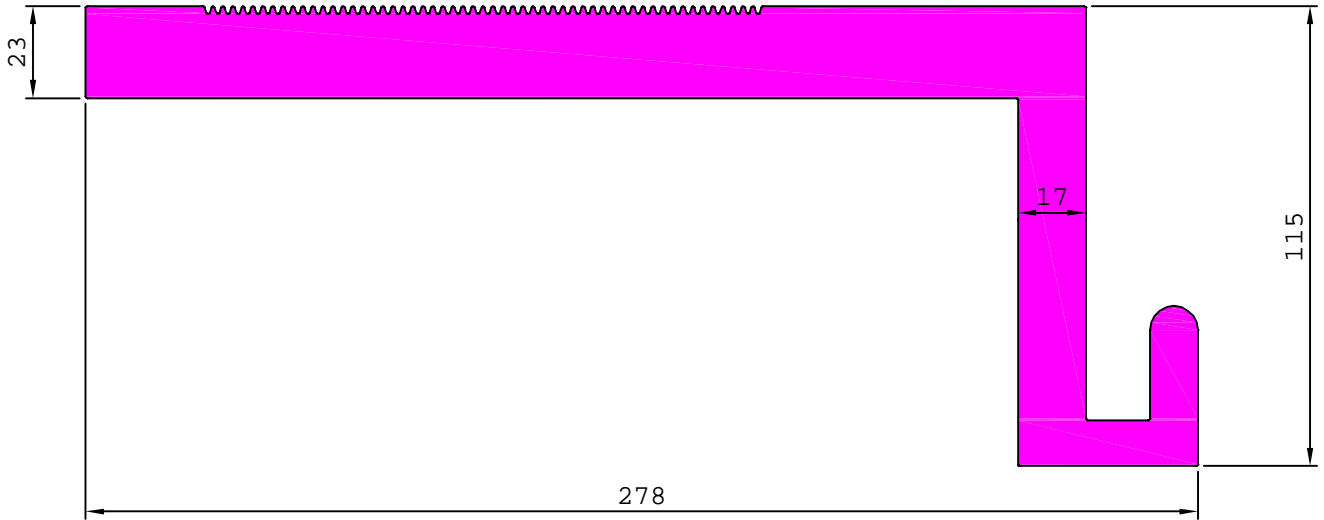

MATCHING WITH G101211

G101430

14.643 kg/m

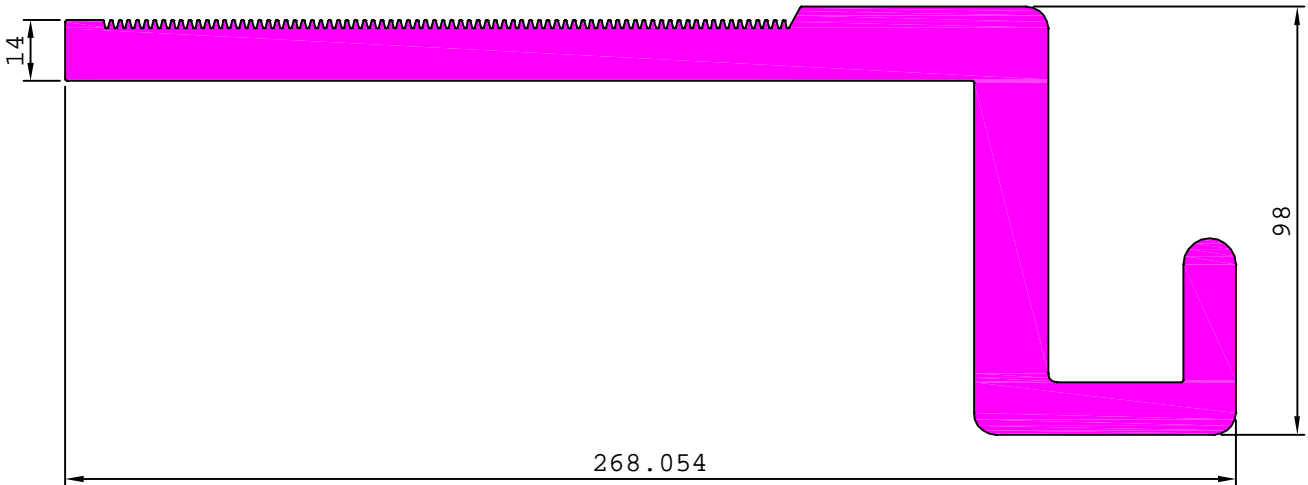

G100013

14.808 kg/m

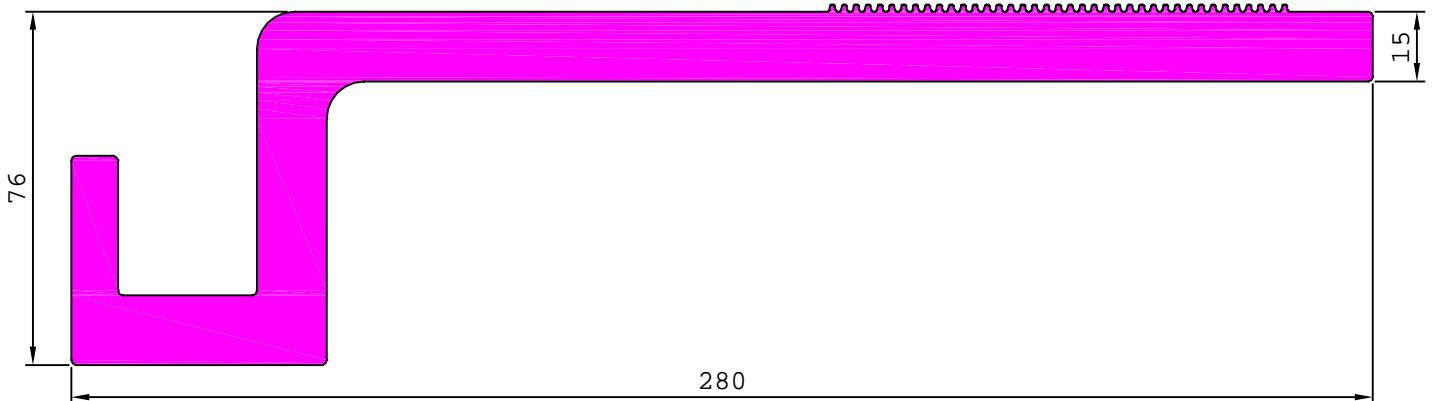

## CURTAIN WALL SECTION

G101935

28.548 kg/m

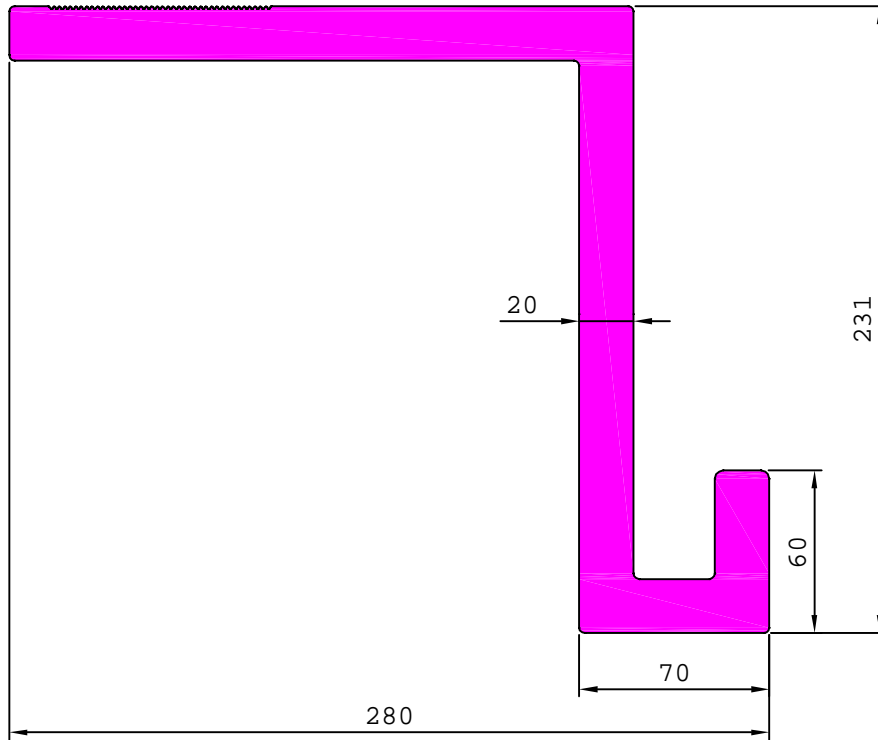

MATCHING WITH G101936

G101909

13.785 kg/m

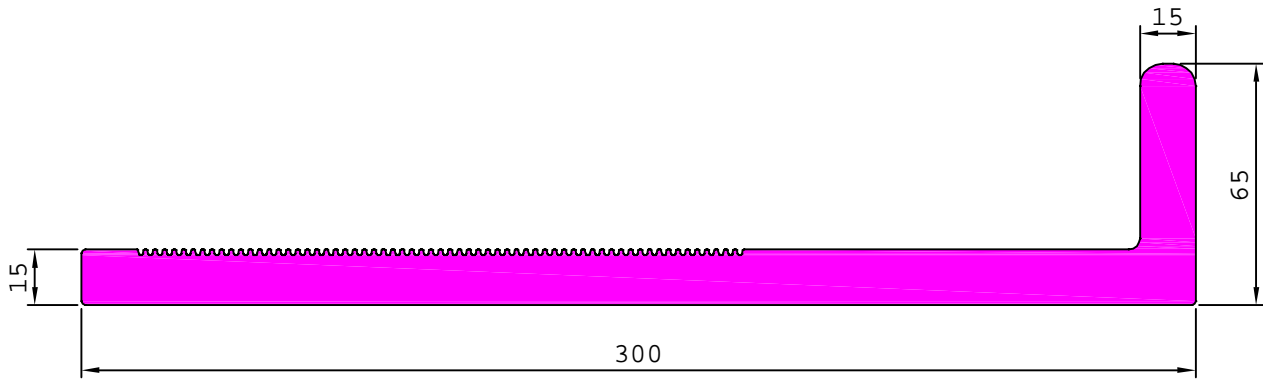

MATCHING WITH S6741

G102056

12.841 kg/m

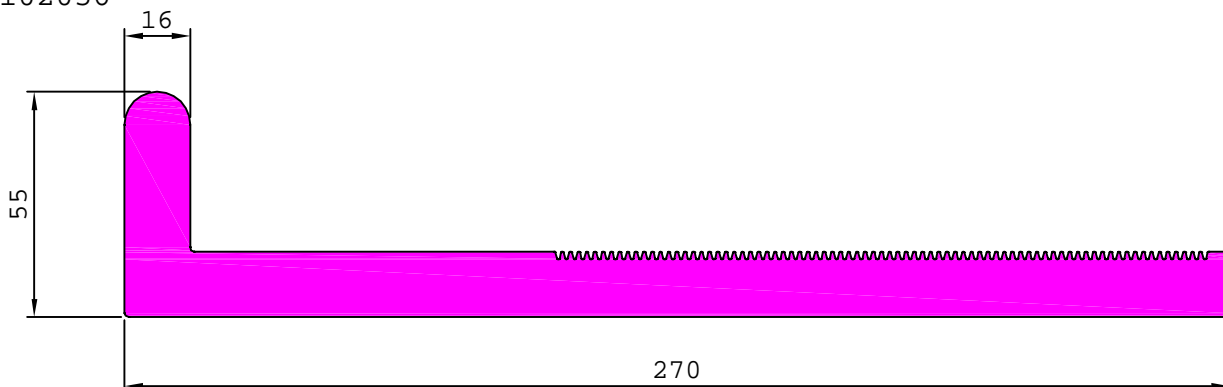

MATCHING WITH G102055

## CURTAIN WALL SECTION

G101211

0.675 kg/m

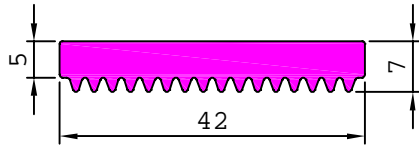

MATCHING WITH G101210

G101439

0.393 kg/m

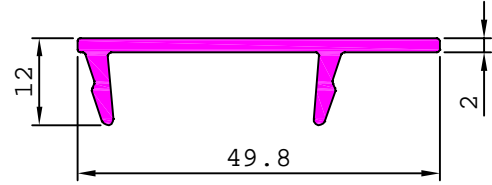

MATCHING WITH G101432

G101935

28.548 kg/m

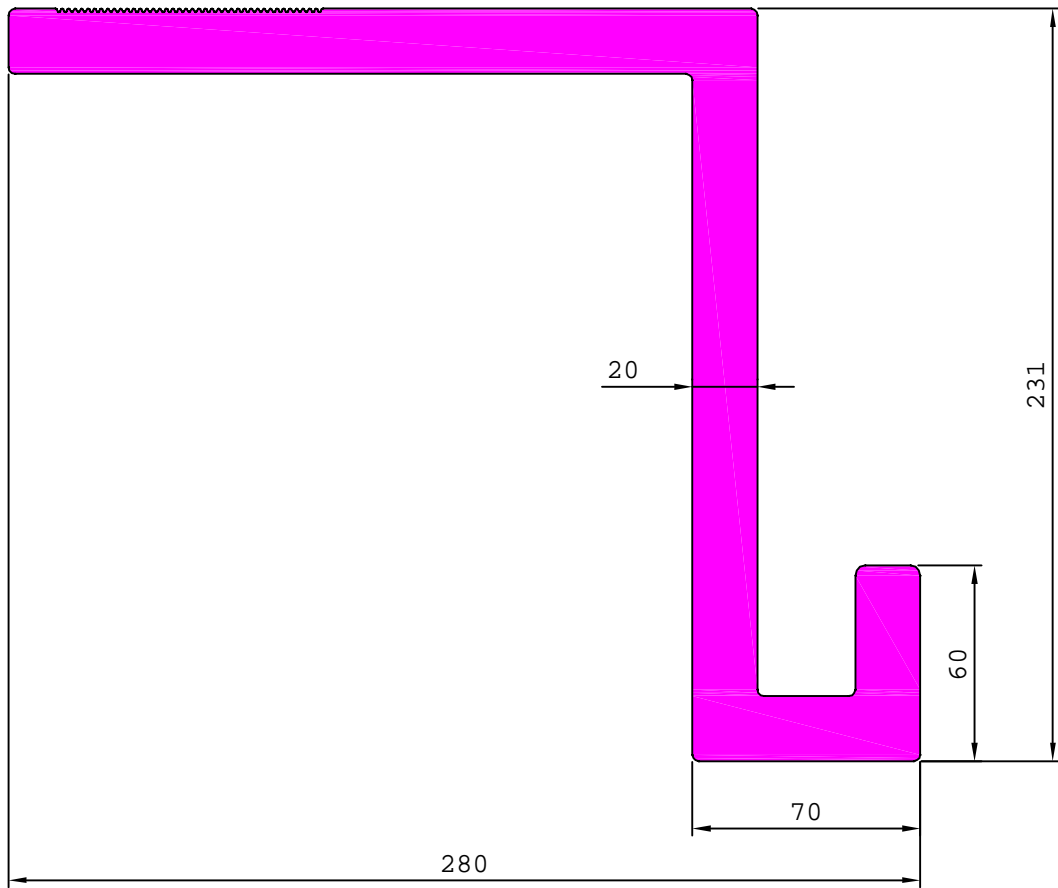

MATCHING WITH G101936

G102237

11.546 kg/m

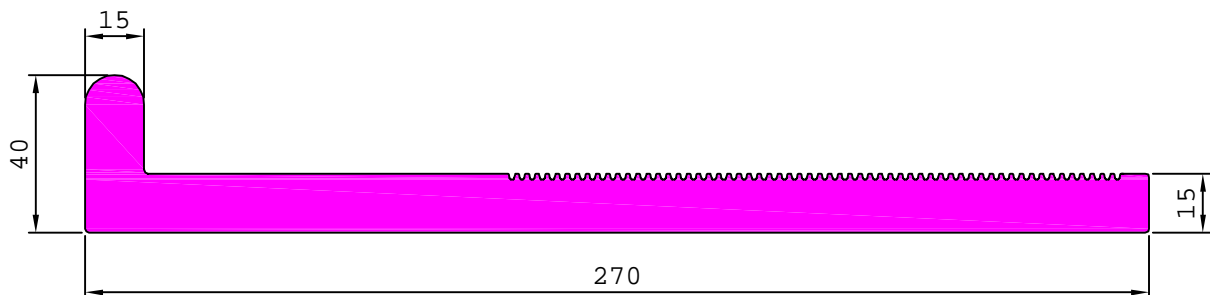

MATCHING WITH S6741

## CURTAIN WALL SECTION

G101936 0.464 kg/m

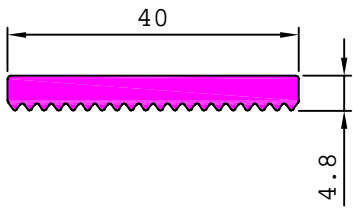

MATCHING WITH G101935

G102055 0.648 kg/m

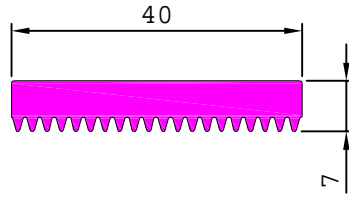

MATCHING WITH G102056

G103414 0.569 kg/m

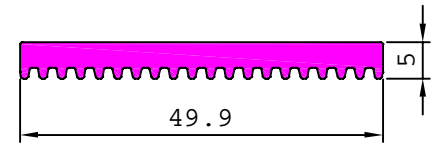

MATCHING WITH G103413

G103517

11.703 kg/m

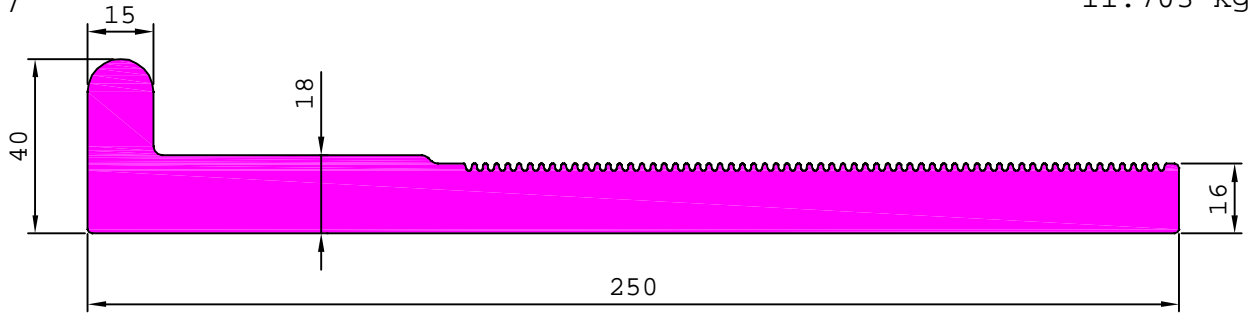

MATCHING WITH G103414

G103413

16.796 kg/m

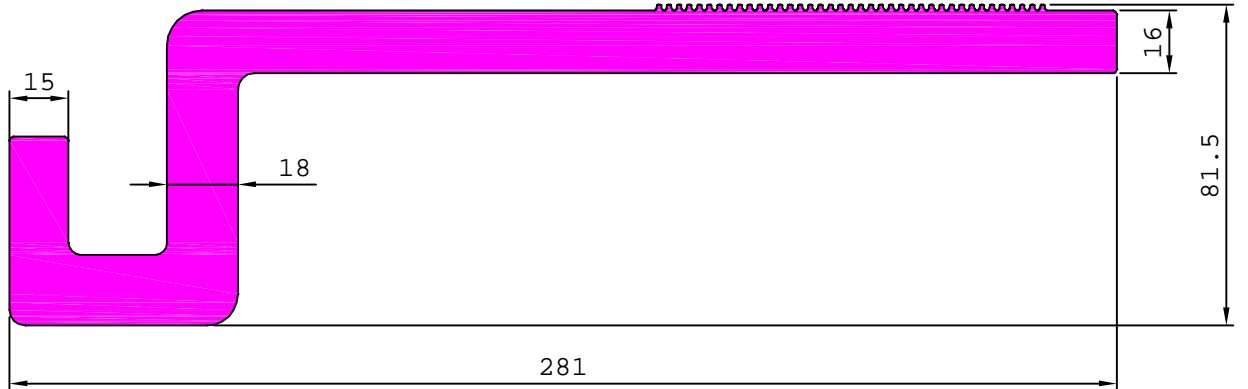

MATCHING WITH G103414

G104363

19.371 kg/m

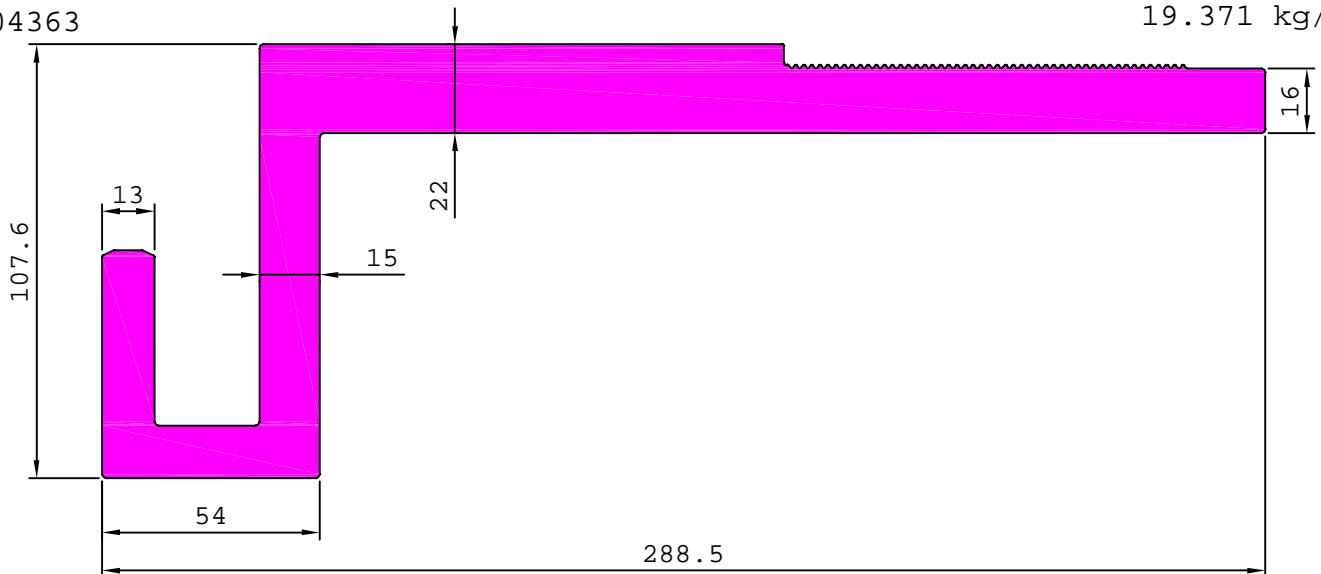

MATCHING WITH G101936

## CURTAIN WALL SECTION

G104058 0.455 kg/m

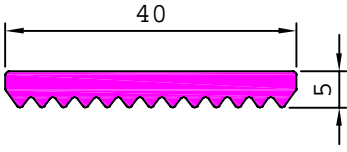

MATCHING WITH 36285

## CURTAIN WALL SECTION - TOGGLE

29073

0.230 kg/m

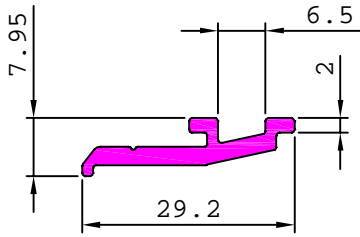

**MATCHING WITH S6496,S6219,22841,  
36371,G101890,G101888,G101888,  
G102860**

29104

0.218 kg/m

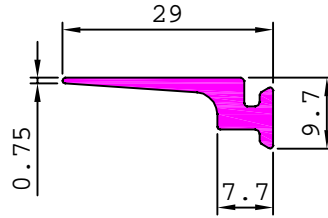

35660

0.304 kg/m

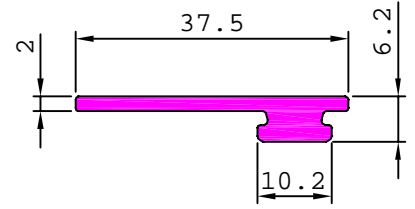

35644

0.083 kg/m

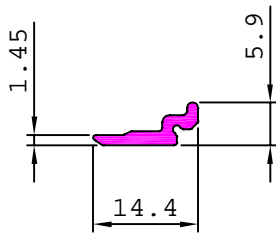

35781

0.305 kg/m

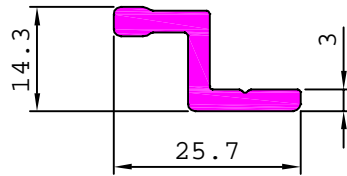

35784

0.314 kg/m

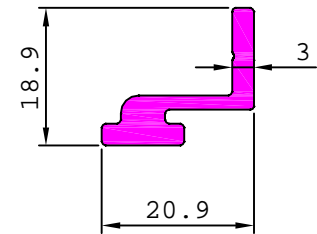

**MATCHING WITH S6733**

35803

0.160 kg/m

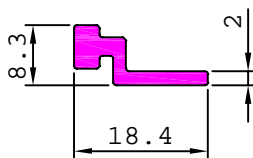

35809

0.358 kg/m

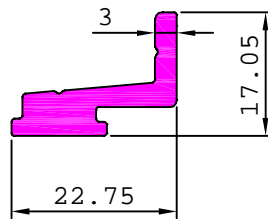

35878

0.177 kg/m

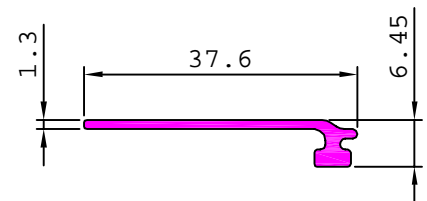

**MATCHING WITH 35671,35813**

**MATCHING WITH 35874,35877**

35879

0.238 kg/m

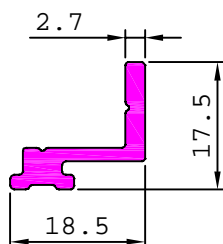

35947

0.268 kg/m

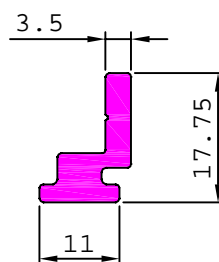

35832

0.207 kg/m

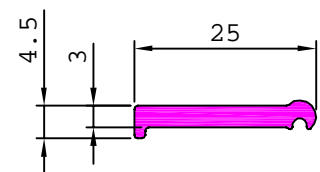

**MATCHING WITH 35874,35877  
G102631**

## CURTAIN WALL SECTION - TOGGLE

36140 0.253 kg/m

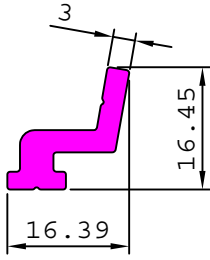

**MATCHING WITH 36141**

35965 0.349 kg/m

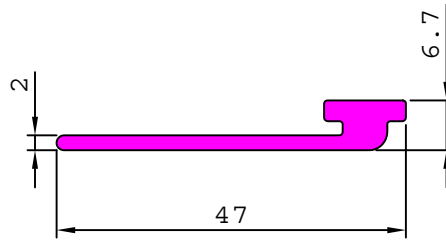

36058 0.216 kg/m

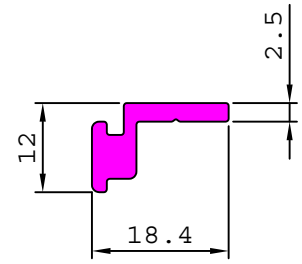

S5589 0.369 kg/m

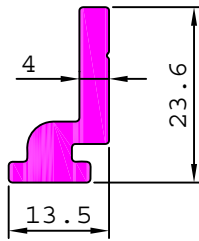

**MATCHING WITH S5545 & S5546**

S5833 0.296 kg/m

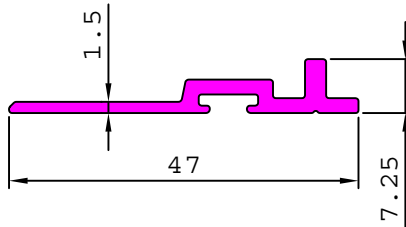

S5834 0.335 kg/m

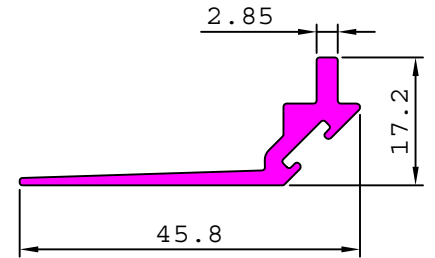

S6170 0.400 kg/m

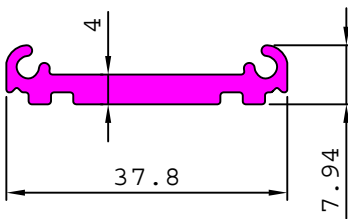

S5655 0.375 kg/m

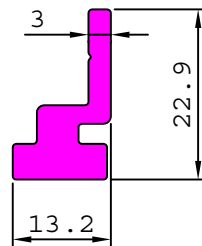

**MATCHING WITH S5653 & S5654**

36191 0.223 kg/m

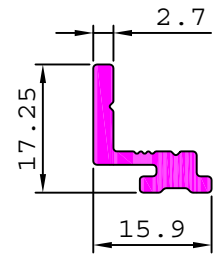

**MATCHING WITH 36189**

G103047 0.172 kg/m

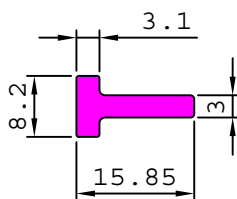

## CURTAIN WALL SECTION - TOGGLE

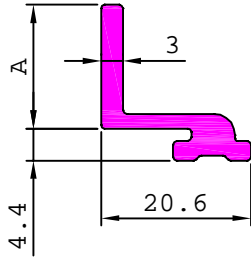

SL. No.	Section No.	A	Weight kg/m
1	<b>S6817</b>	14.00	0.289
2	<b>S6715</b>	17.00	0.313
3	<b>S6752</b>	20.00	0.338

MATCHING WITH 36251

## CURTAIN WALL SECTION - TOGGLE

29038

0.268 kg/m

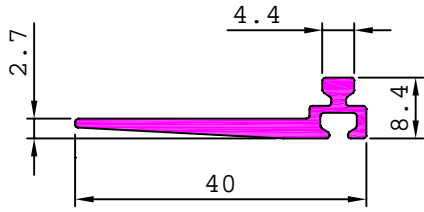

29103

0.215 kg/m

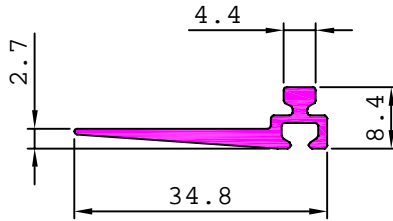

21181

0.171 kg/m

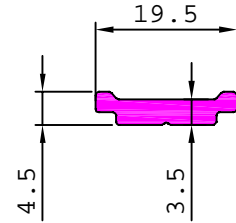

36177

0.217 kg/m

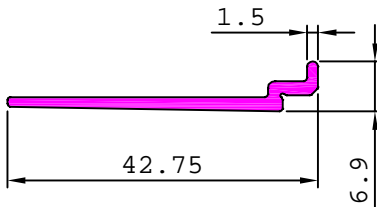

**MATCHING WITH S5704,S5705  
S5707,S5708,S5709**

36021

0.180 kg/m

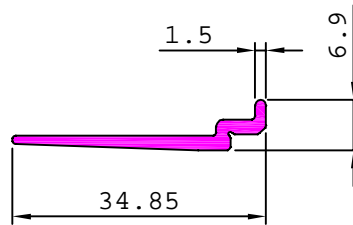

**MATCHING WITH 36019,36020  
36170,36171,36172**

S5930

0.213 kg/m

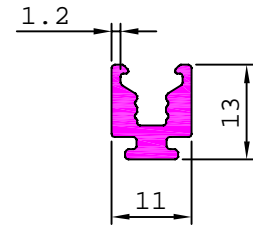

35909

0.179 kg/m

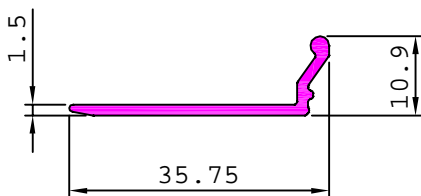

**MATCHING WITH 35908,35910,35912,  
35915**

G100595

0.185 kg/m

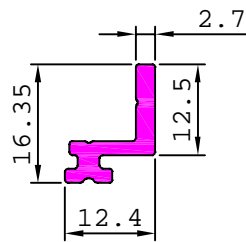

G101097

0.142 kg/m

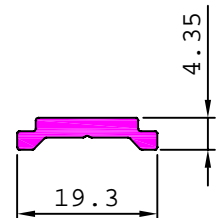

G101289

0.189 kg/m

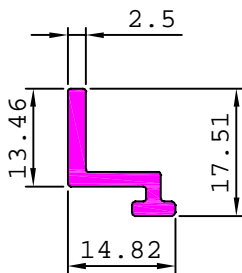

G101765

0.241 kg/m

