

LOUVER SECTION

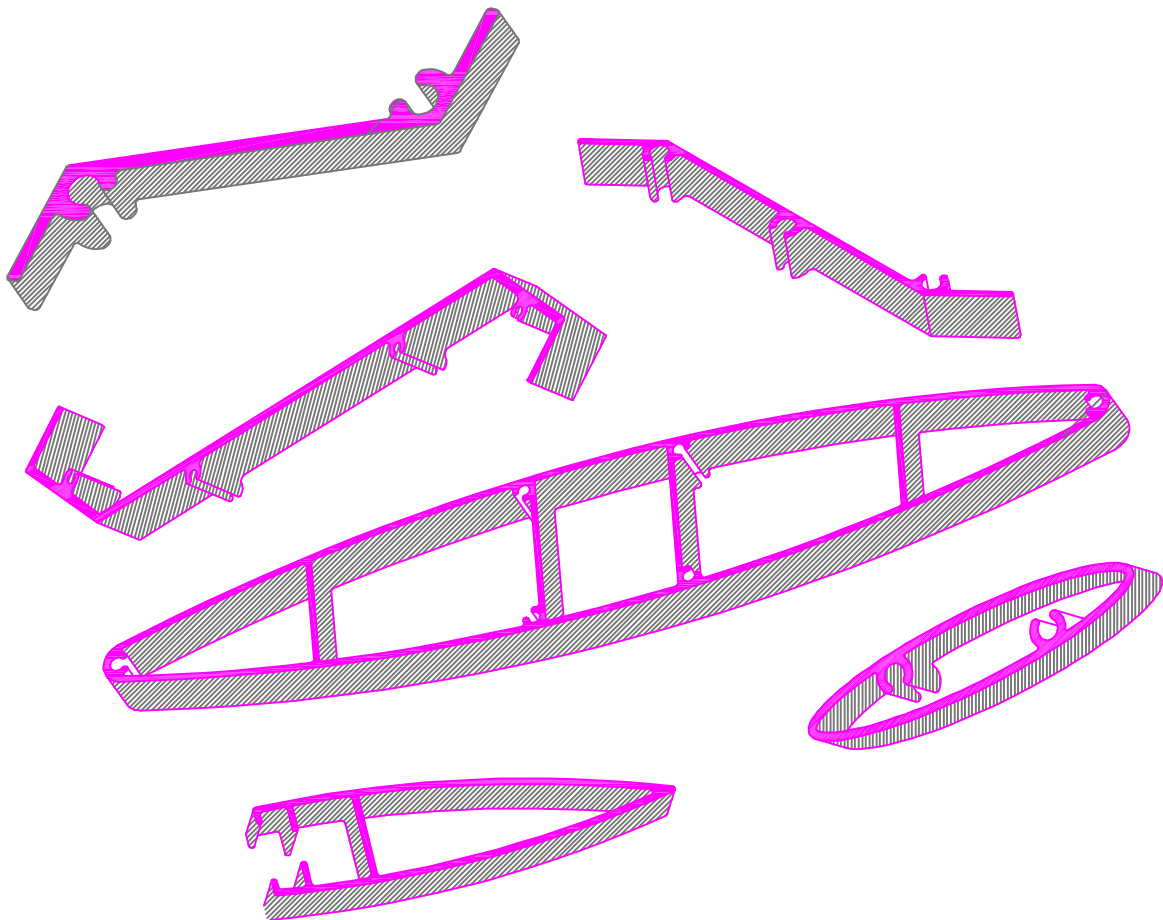
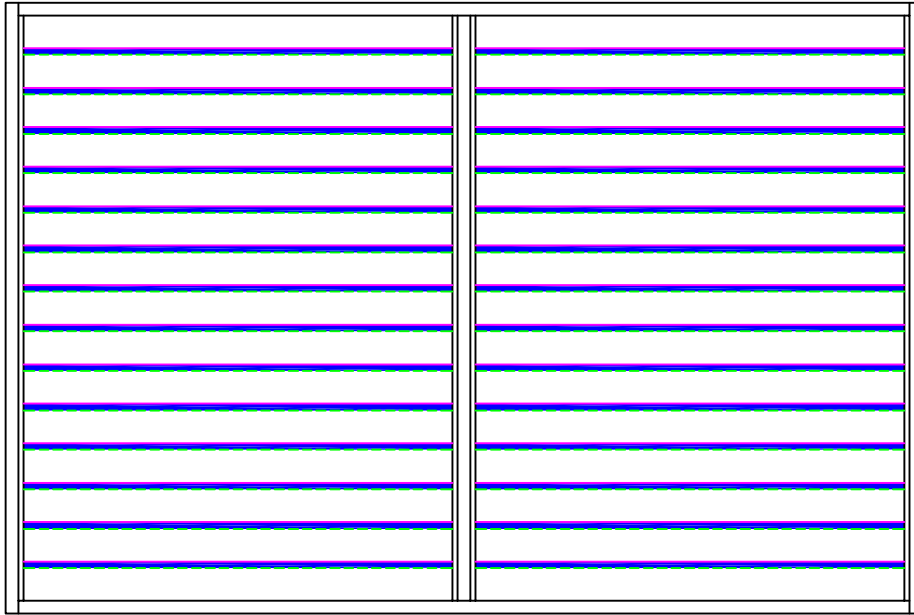

LOUVER SECTION

20552

0.599 kg/m

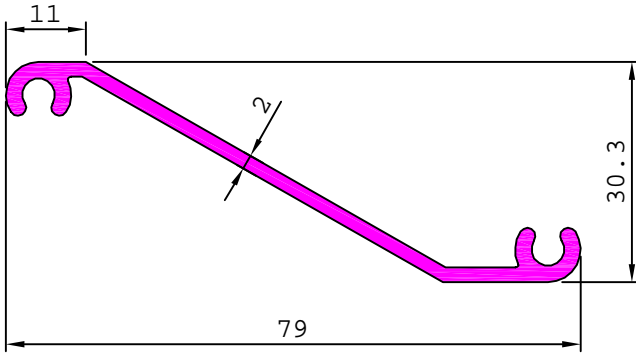

20778

0.483 kg/m

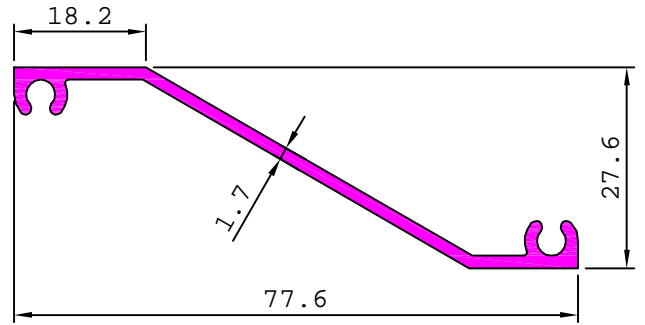

20782

0.429 kg/m

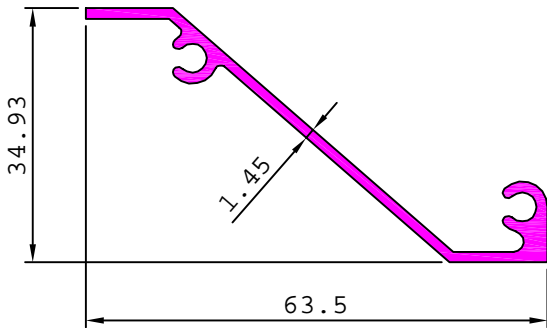

20853

0.391 kg/m

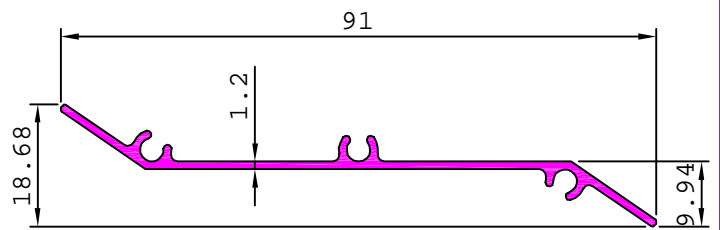

20860

0.249 kg/m

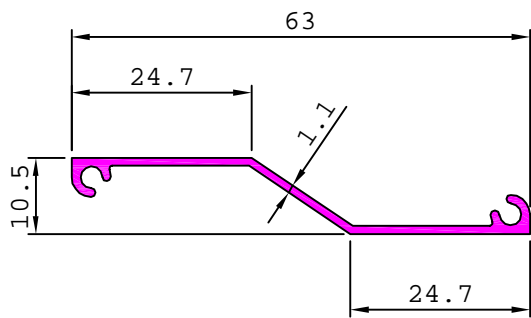

20967

0.369 kg/m

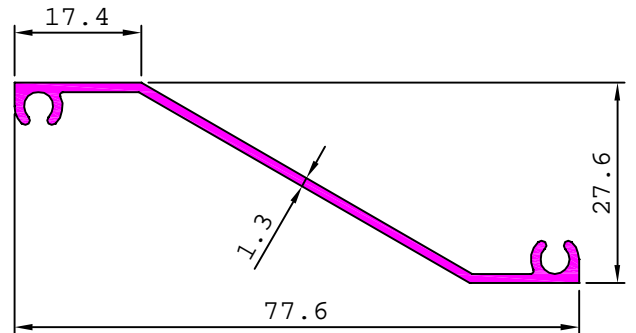

20970

0.248 kg/m

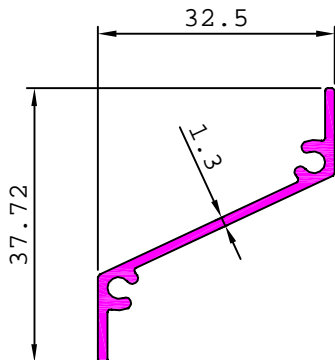

21150

0.519 kg/m

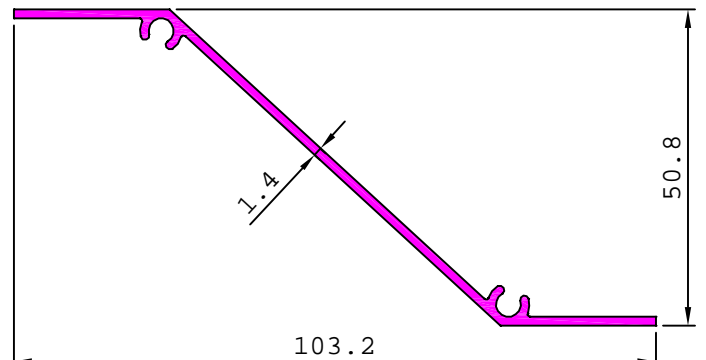

LOUVER SECTION

21305

0.402 kg/m

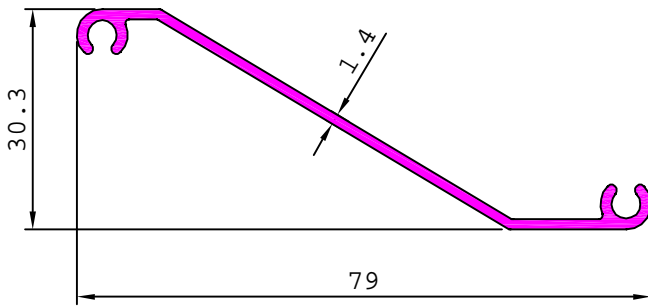

21318

0.514 kg/m

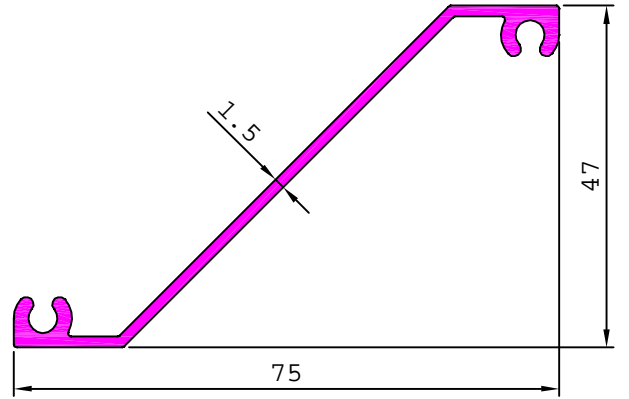

21334

0.543 kg/m

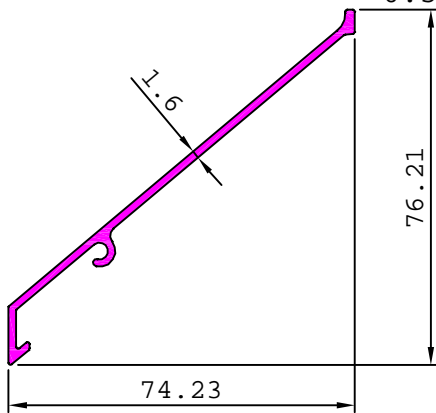

21347

0.420 kg/m

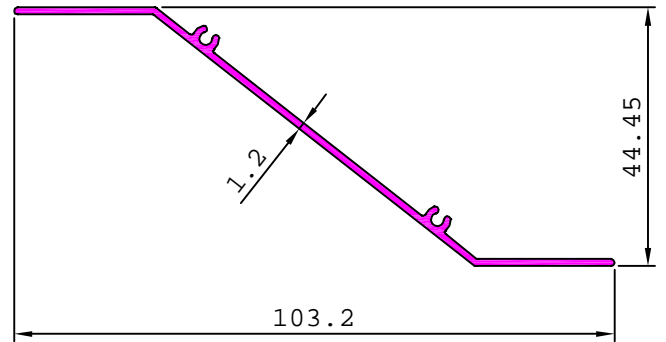

21351

0.288 kg/m

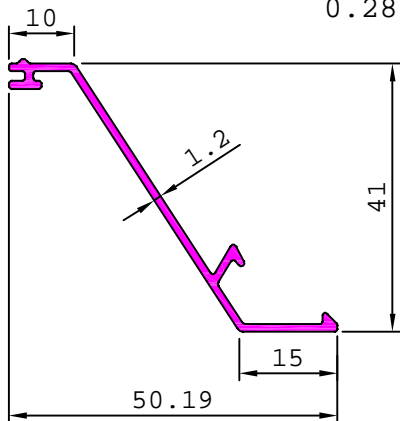

21451

0.249 kg/m

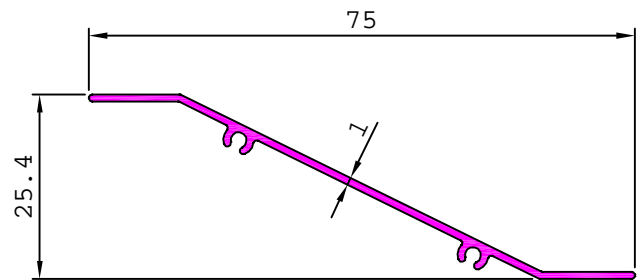

21472

1.111 kg/m

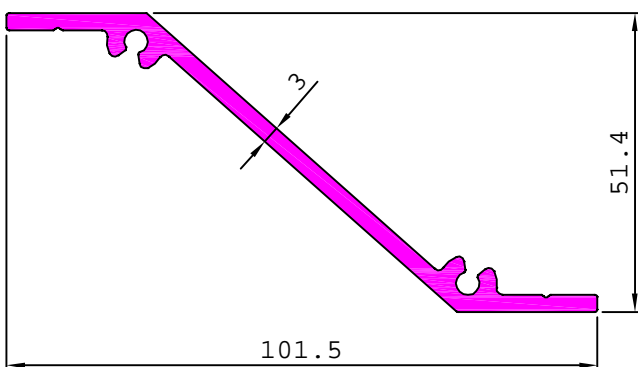

21713

0.385 kg/m

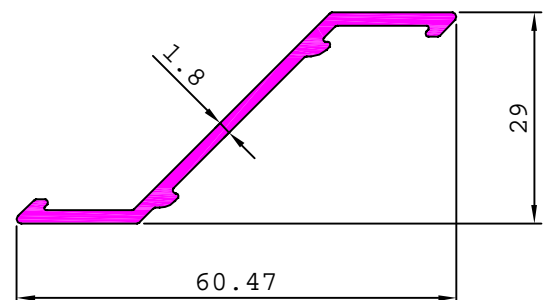

MATCHING WITH 21712

LOUVER SECTION

S6374

1.582 kg/m

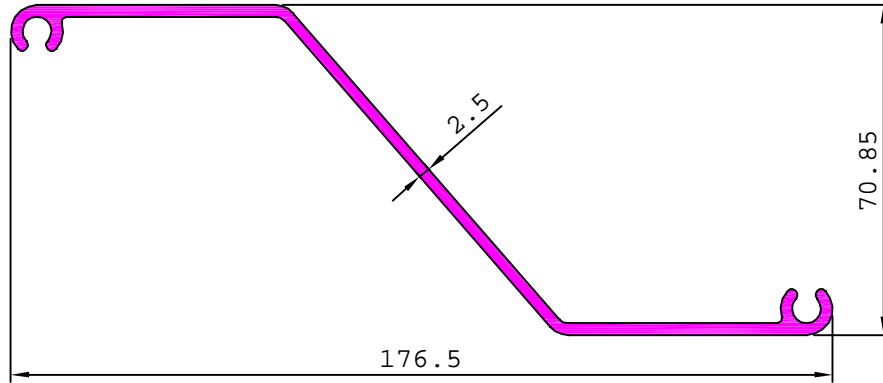

S6381

0.805 kg/m

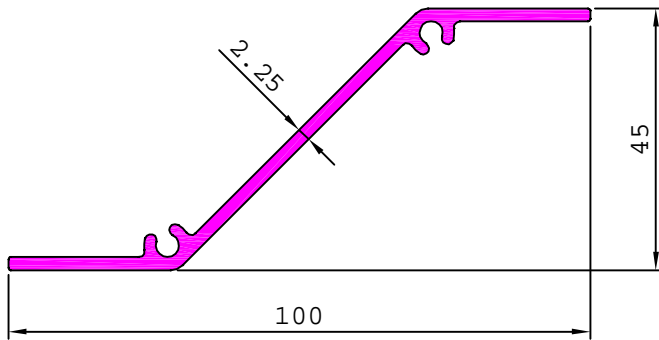

S6495

0.689 kg/m

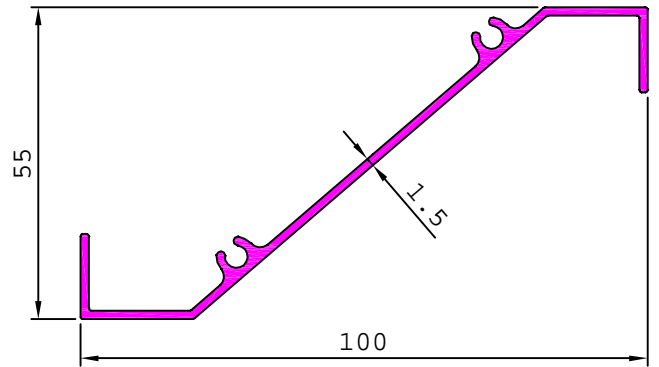

21936

0.744 kg/m

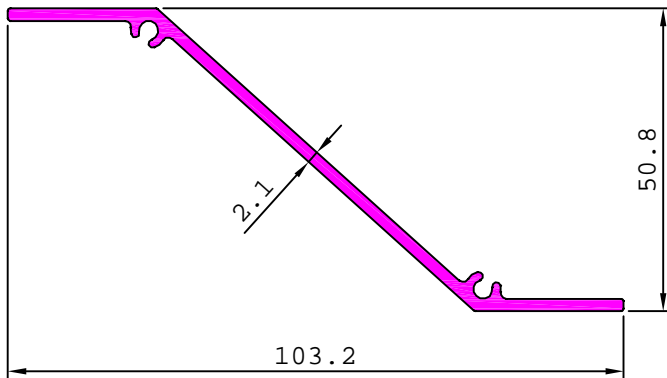

21945

0.454 kg/m

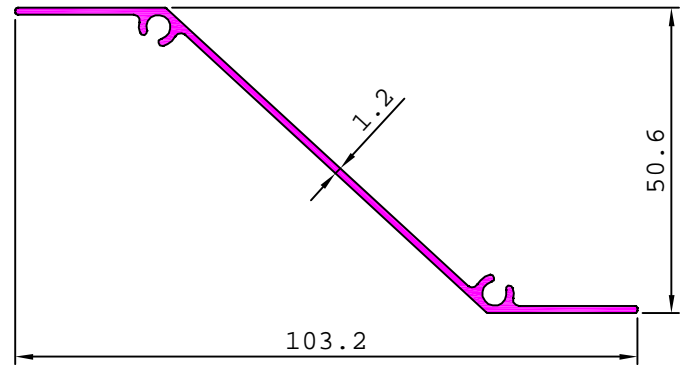

21591

0.610 kg/m

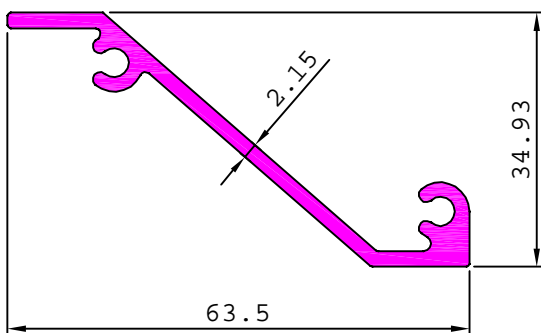

S6387

0.565 kg/m

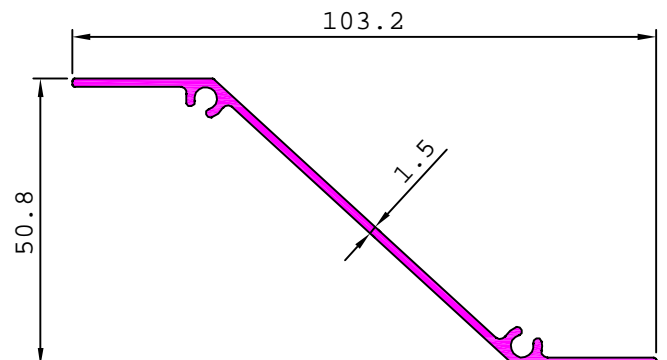

LOUVER SECTION

21820

0.825 kg/m

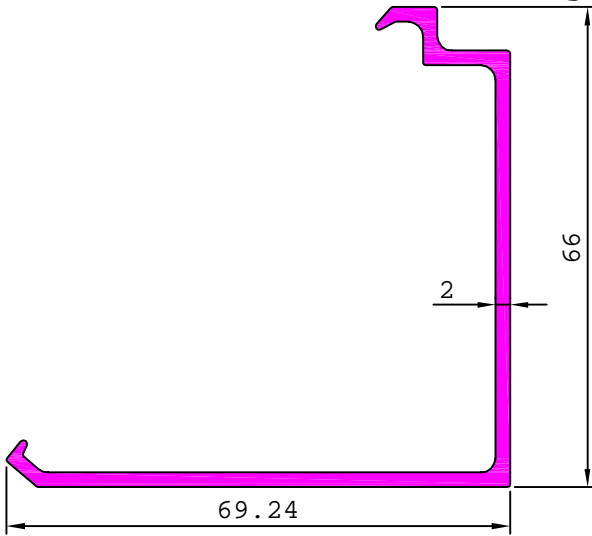

MATCHING WITH 21819

21396

1.058 kg/m

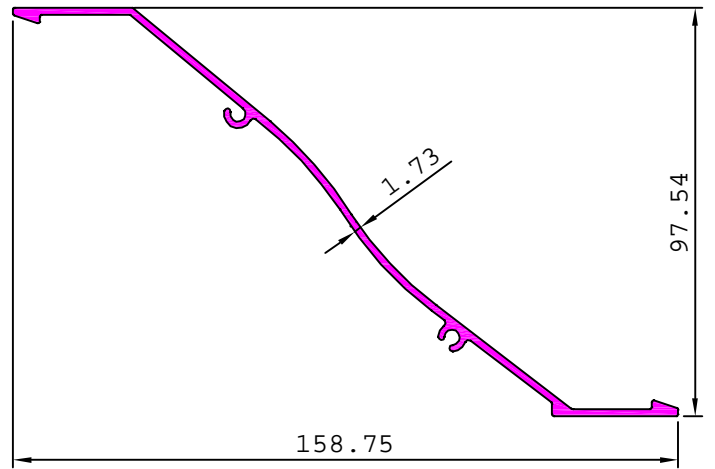

22897

2.216 kg/m

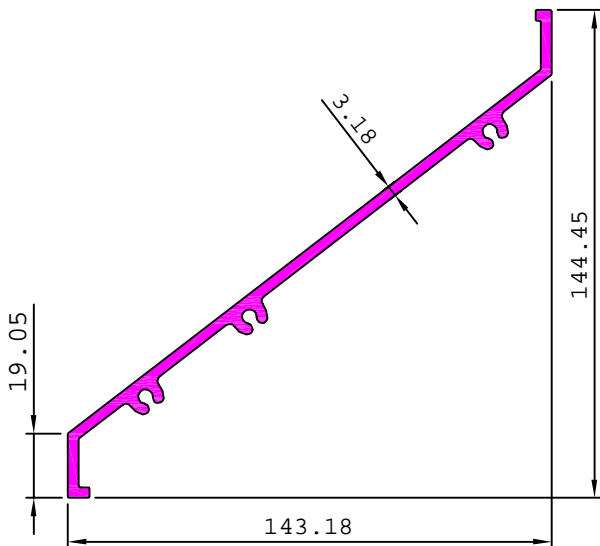

21417

2.014 kg/m

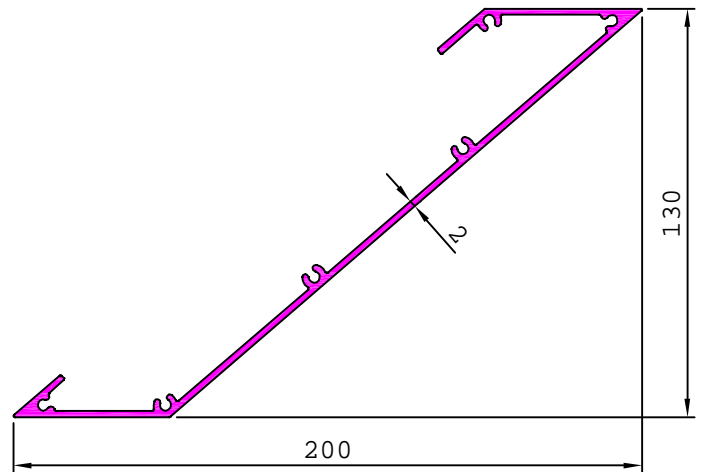

21819

1.203 kg/m

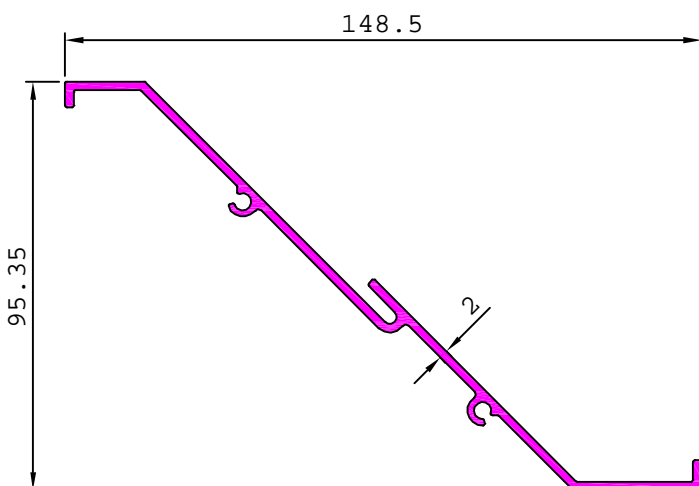

MATCHING WITH 21820

LOUVER SECTION

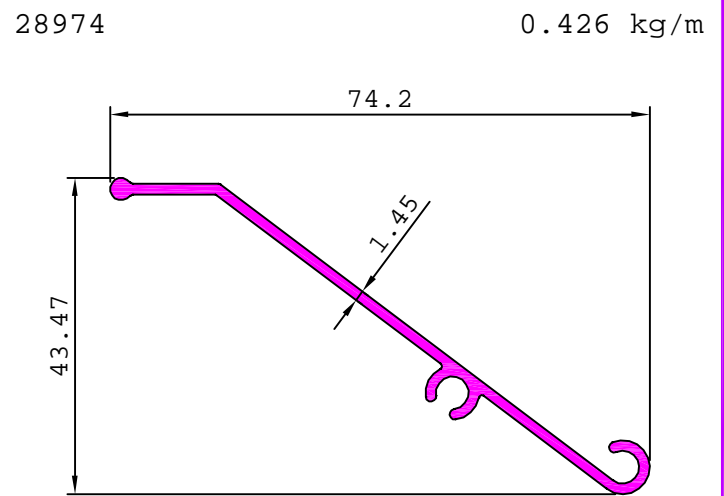
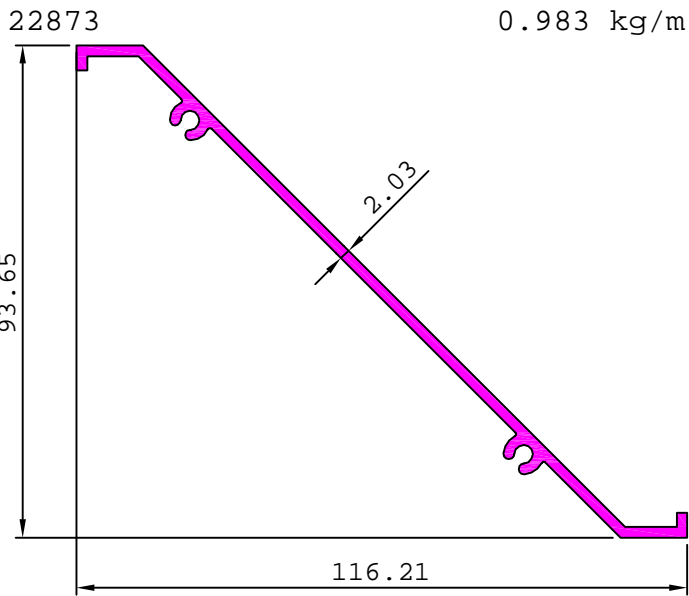

LOUVER SECTION

21240

3.228 kg/m

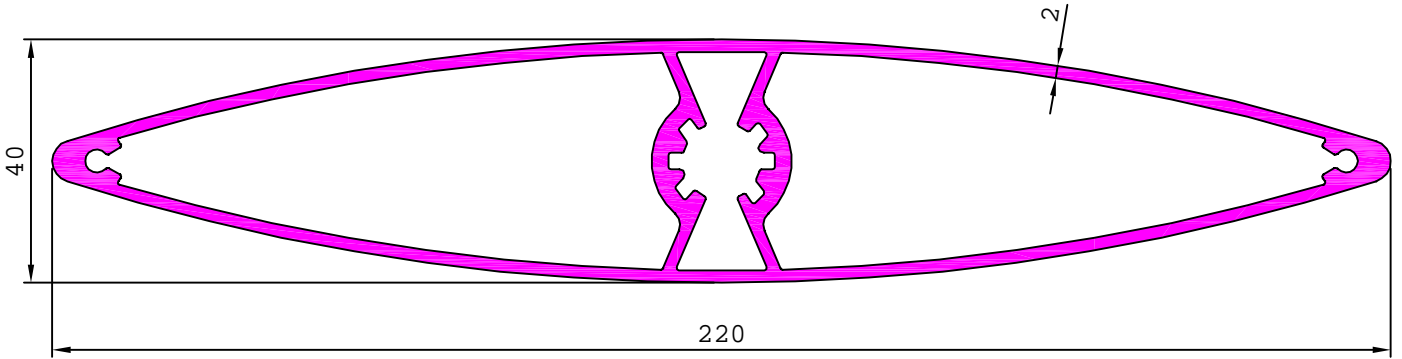

21333

1.086 kg/m

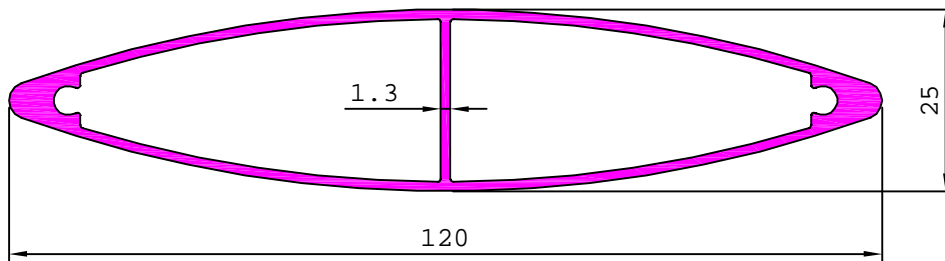

21468

0.843 kg/m

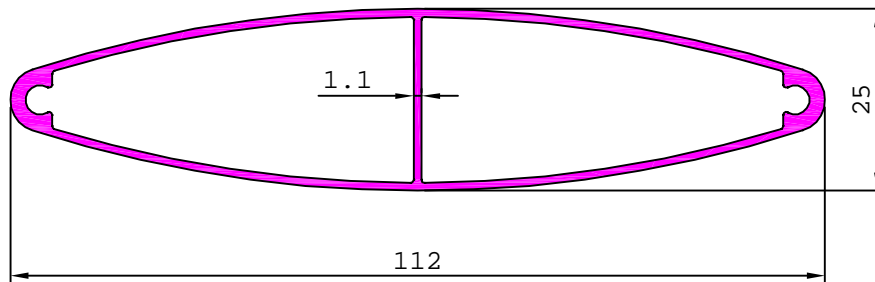

21450

0.678 kg/m

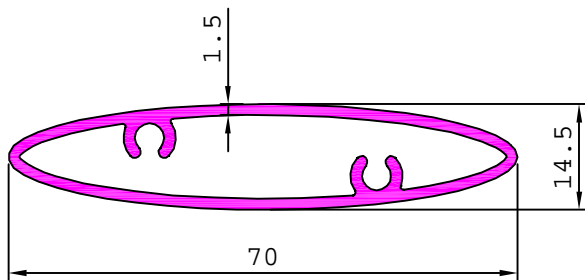

28802

0.706 kg/m

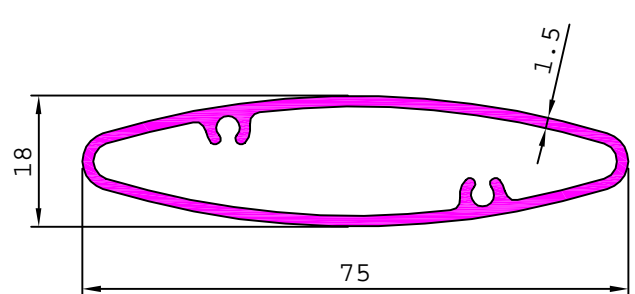

21652

2.740 kg/m

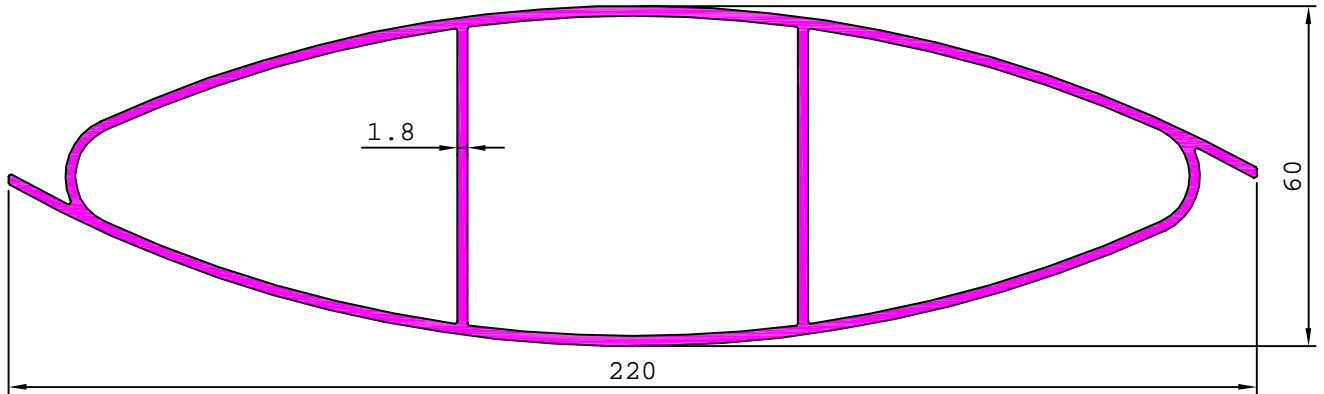

21637

2.038 kg/m

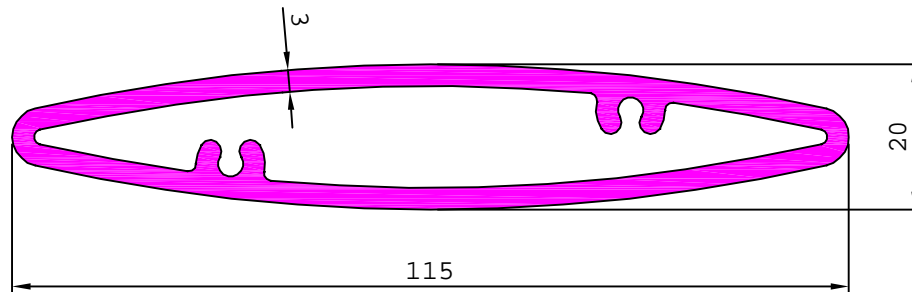

MATCHING WITH 21639

S4669

0.954 kg/m

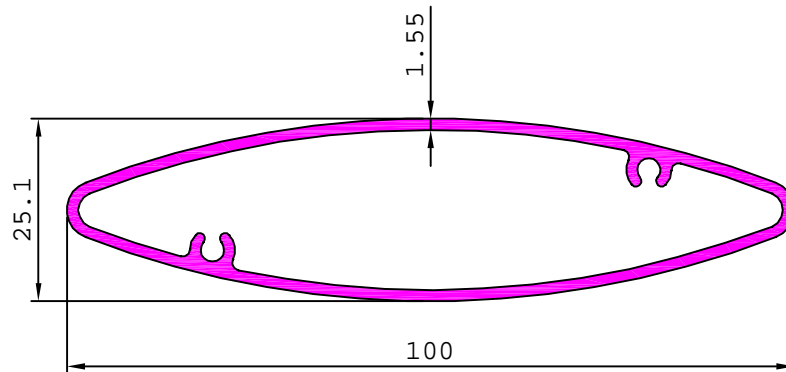

28803

1.573 kg/m

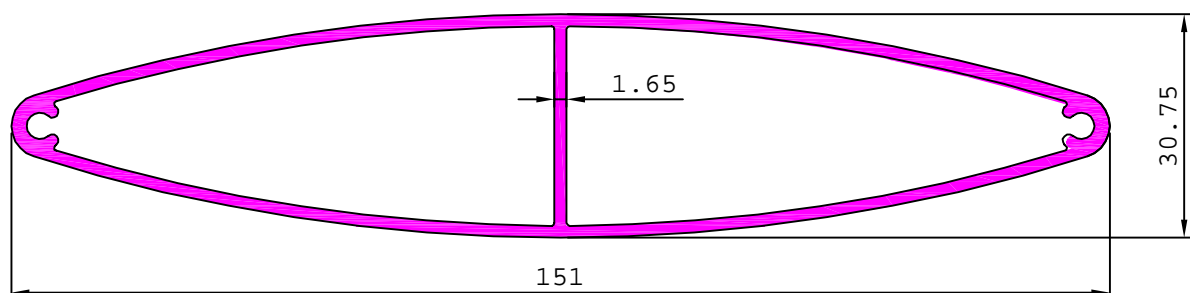

LOUVER SECTION

22560

3.266 kg/m

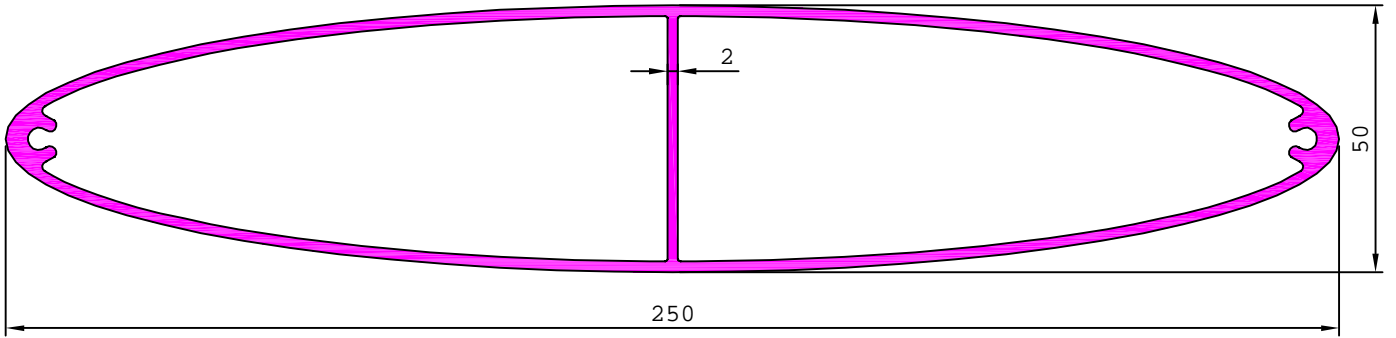

29164

2.511 kg/m

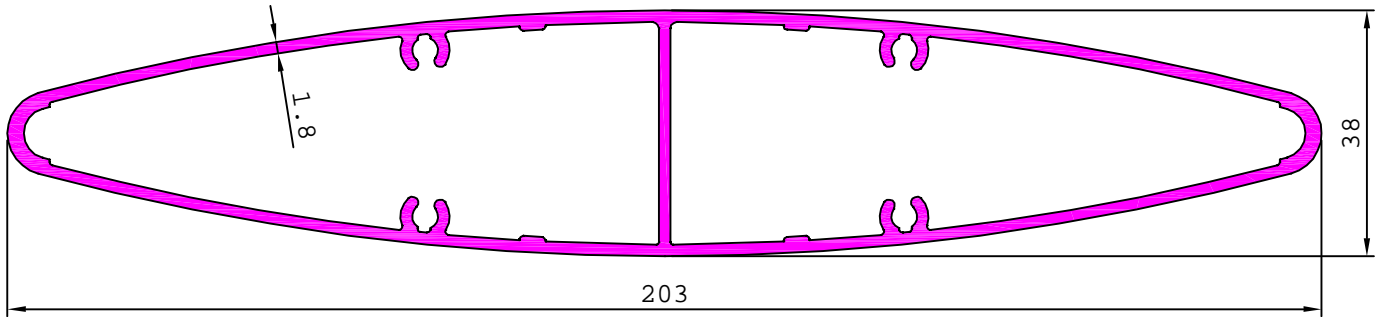

MATCHING WITH 21720

29180

3.646 kg/m

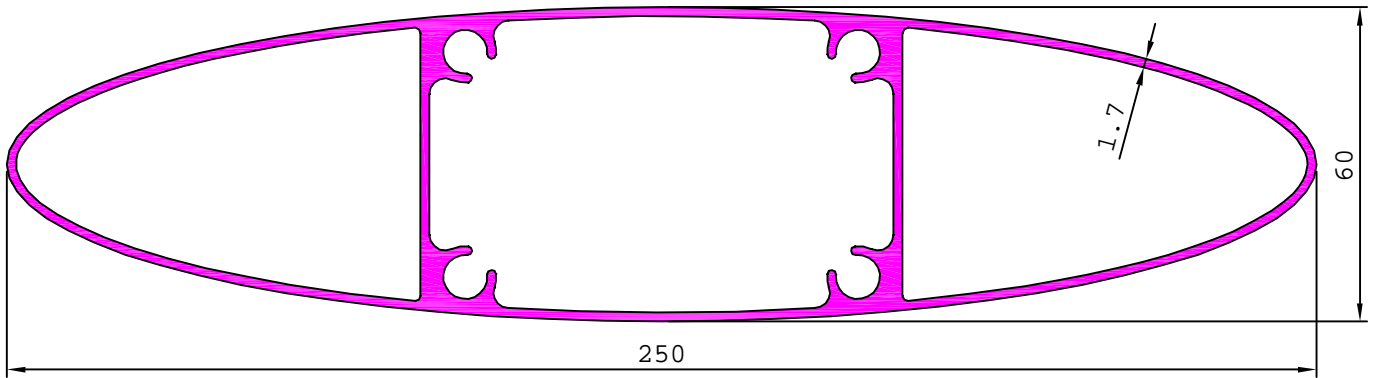

21753

5.576 kg/m

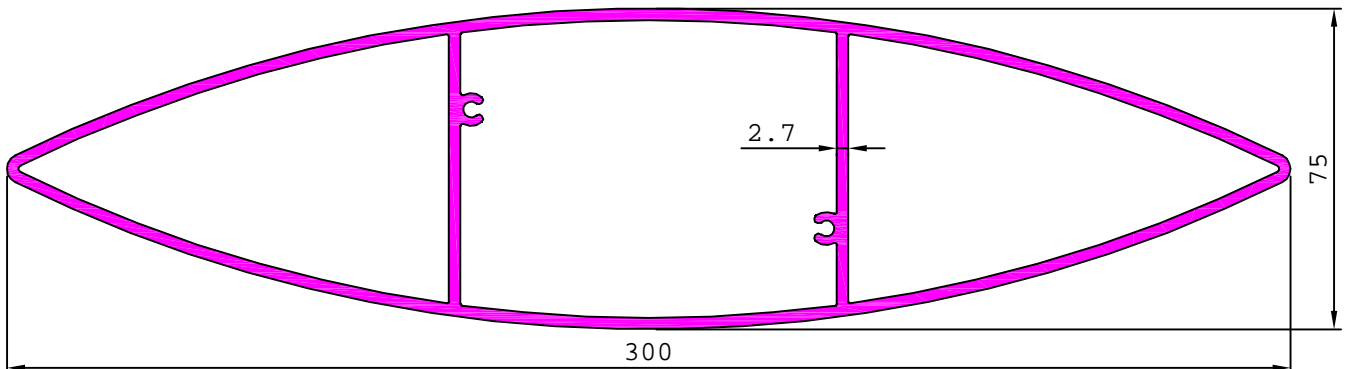

MATCHING WITH 21835

LOUVER SECTION

S5976

5.293 kg/m

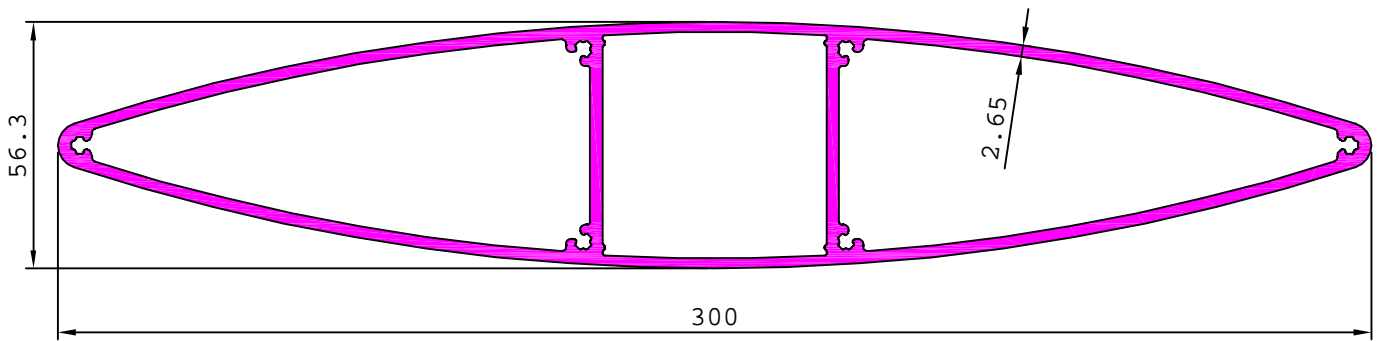

21834

5.199 kg/m

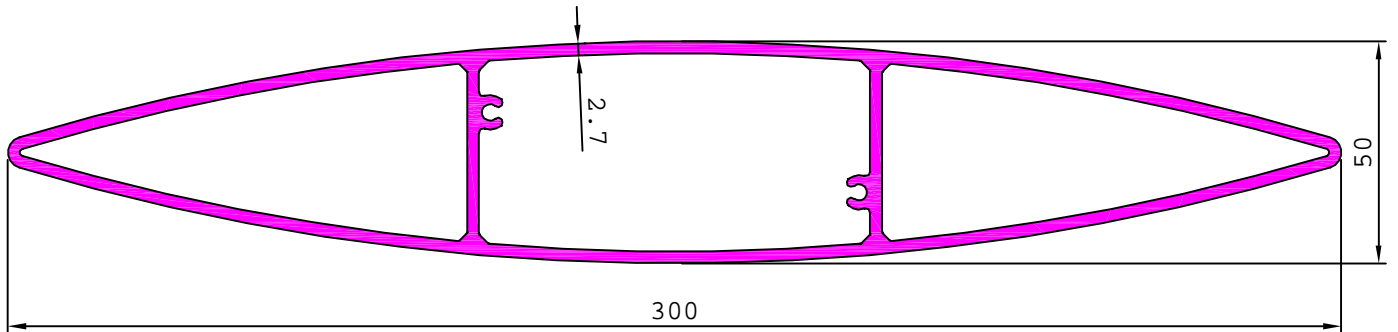

29332

6.336 kg/m

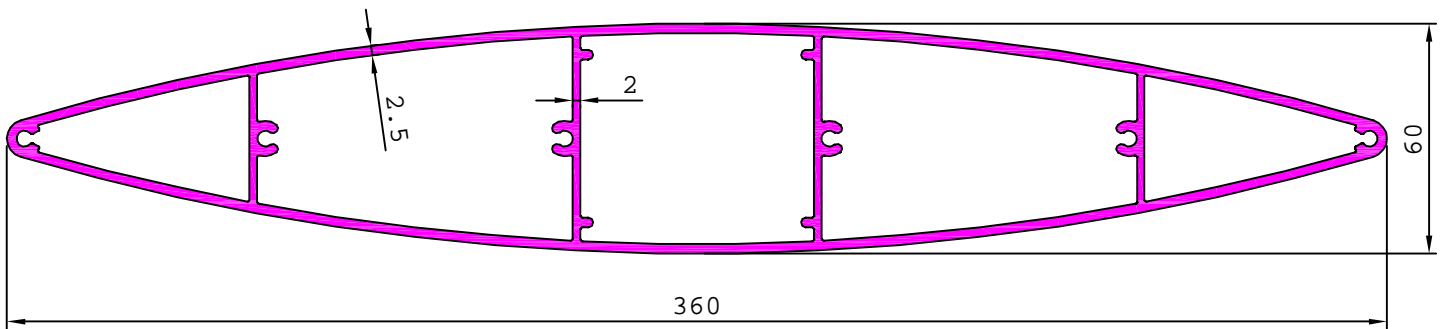

21689

6.093 kg/m

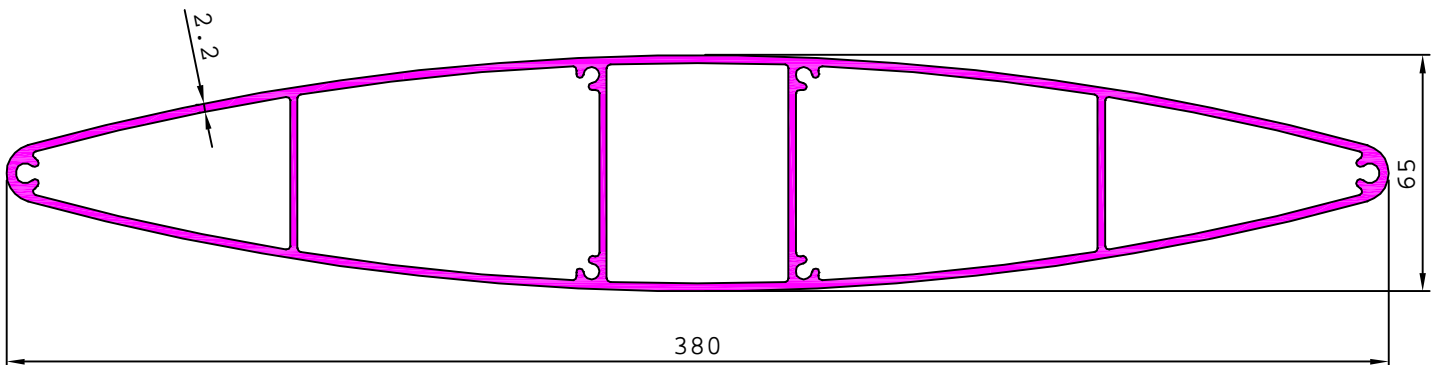

LOUVER SECTION

21776

6.961 kg/m

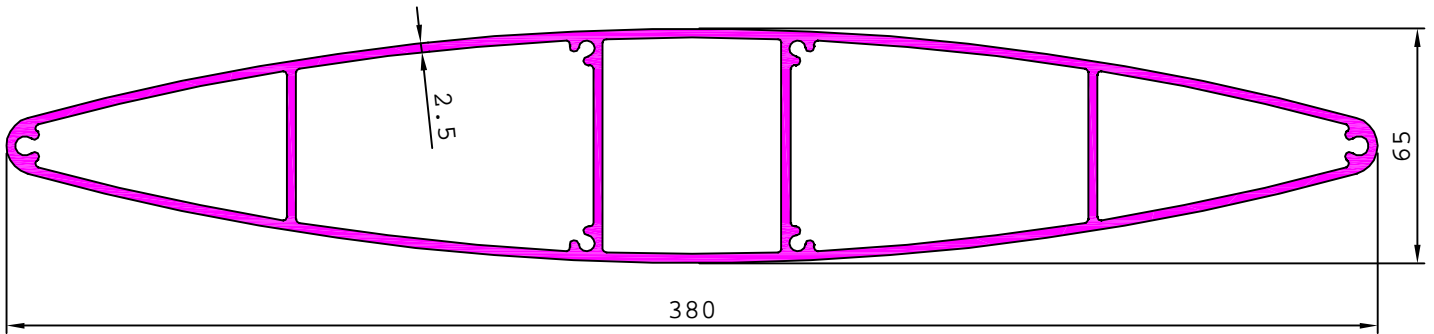

S6567

1.624 kg/m

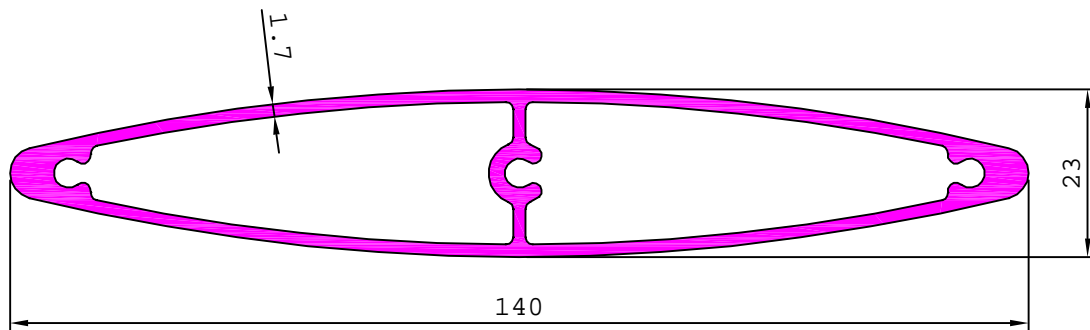

S6498

6.149 kg/m

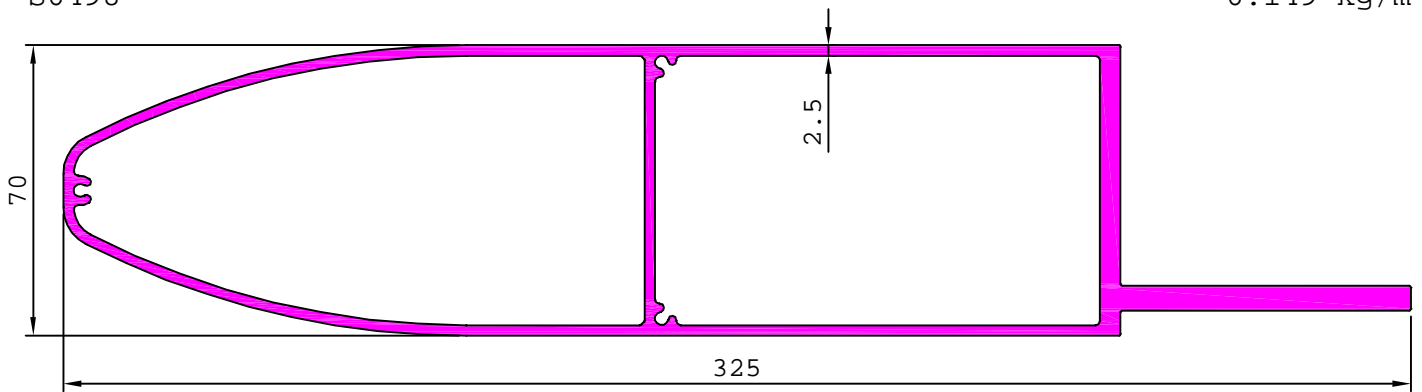

S6587

2.394 kg/m

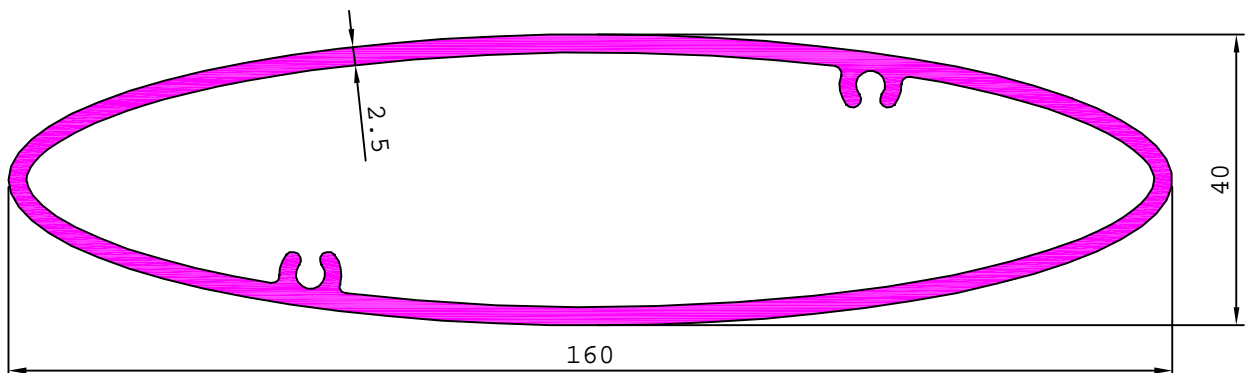

LOUVER SECTION

22852

1.379 kg/m

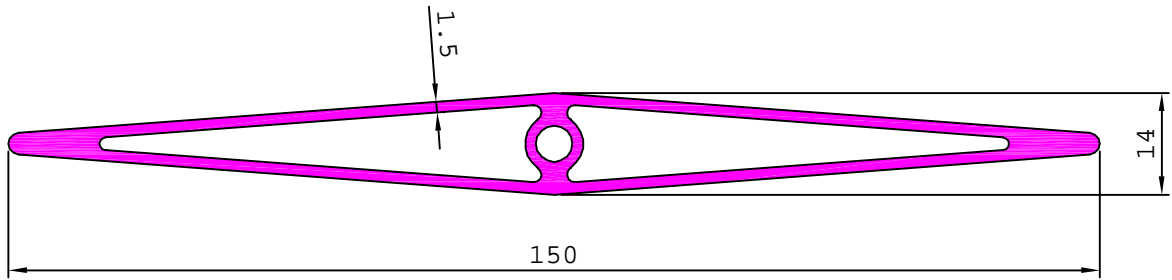

21922

0.693 kg/m

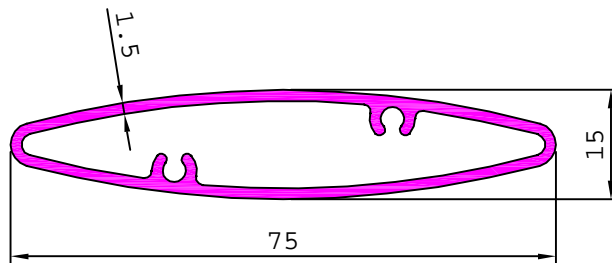

21409

1.547 kg/m

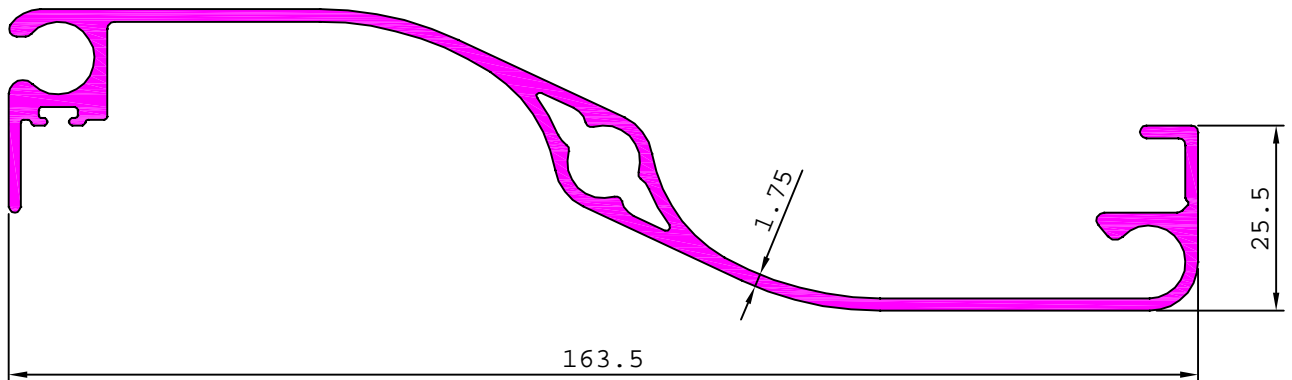

21890

2.540 kg/m

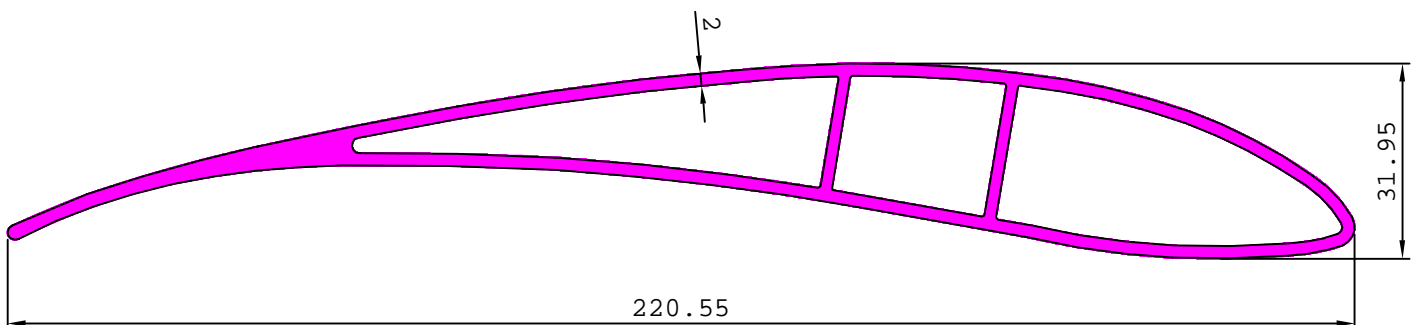

LOUVER SECTION

21802

2.652 kg/m

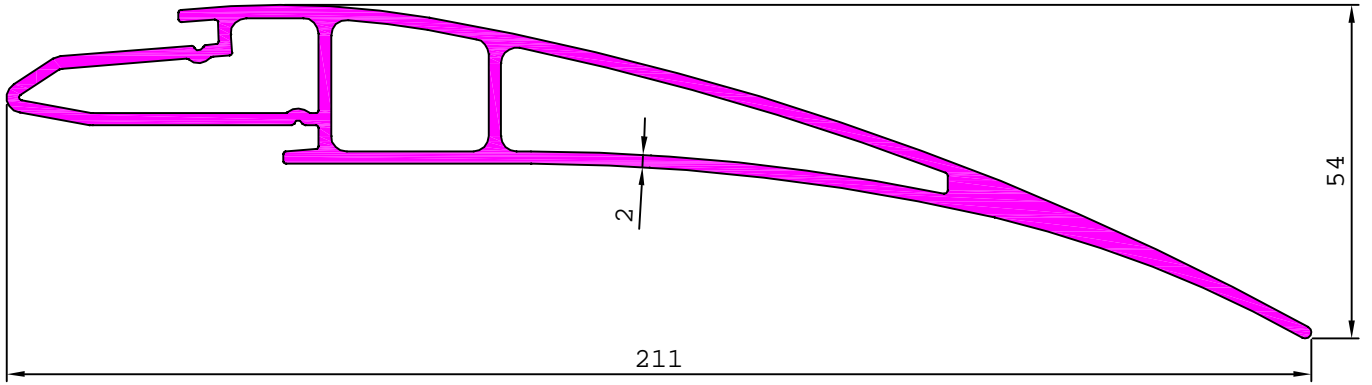

46037

4.159 kg/m

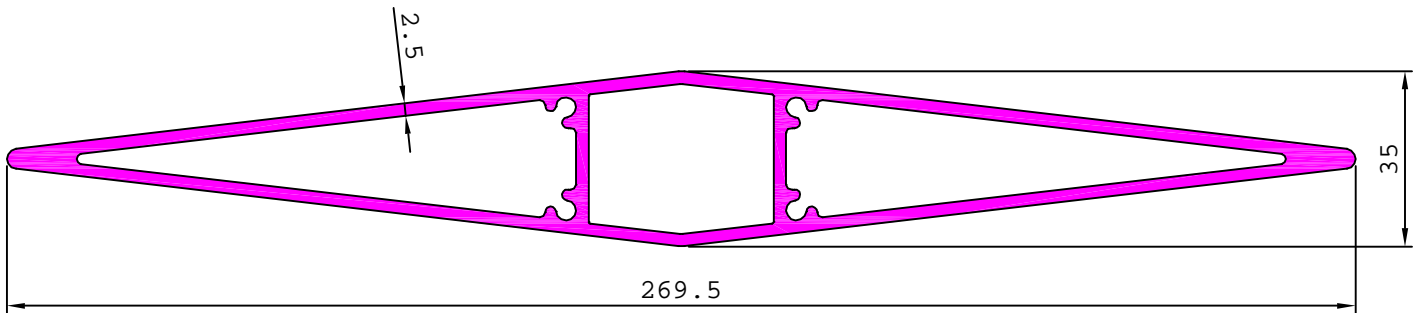

LOUVER SECTION

21408

3.680 kg/m

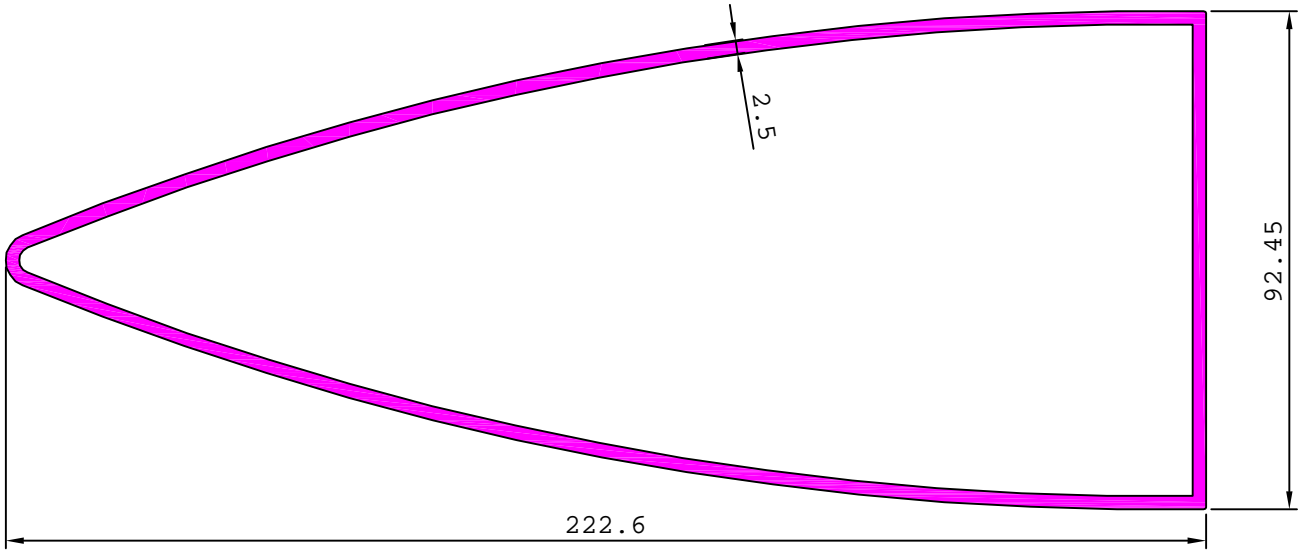

29404

3.048 kg/m

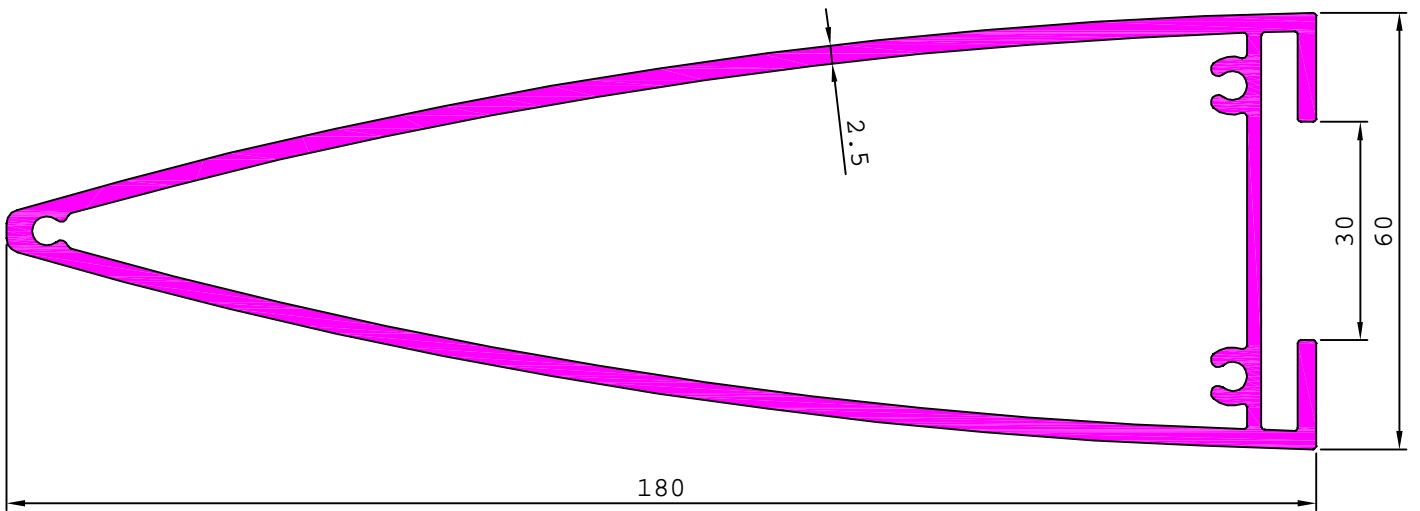

29328

2.477 kg/m

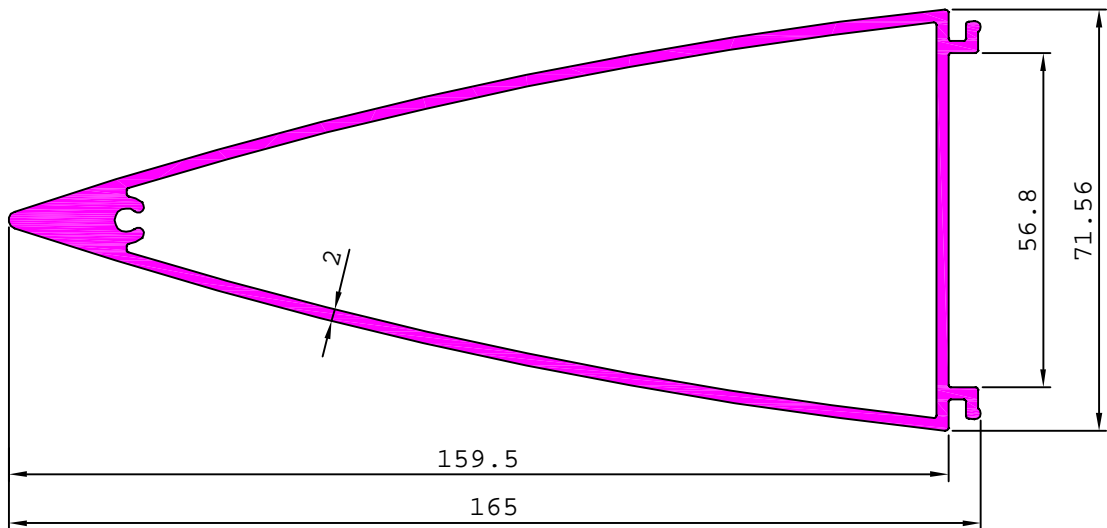

LOUVER SECTION

21595

5.979 kg/m

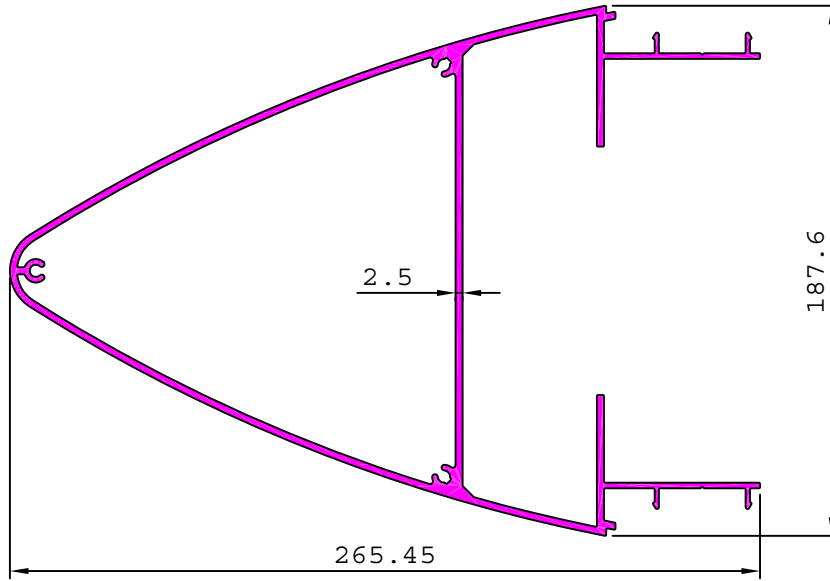

35993

1.109 kg/m

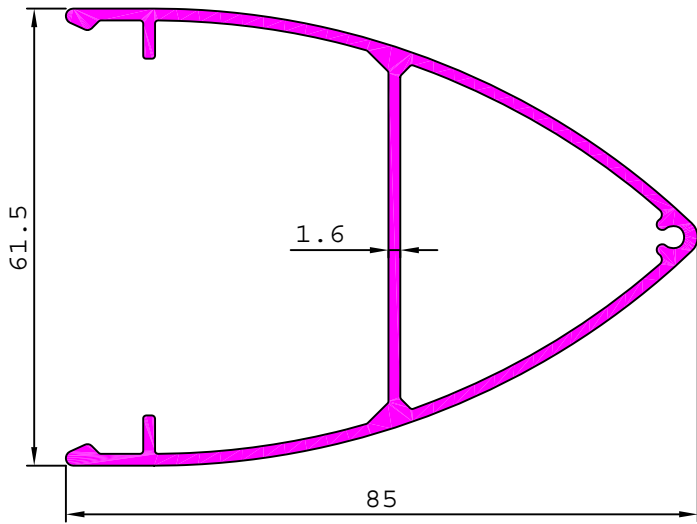

MATCHING WITH 22709

S6568

3.653 kg/m

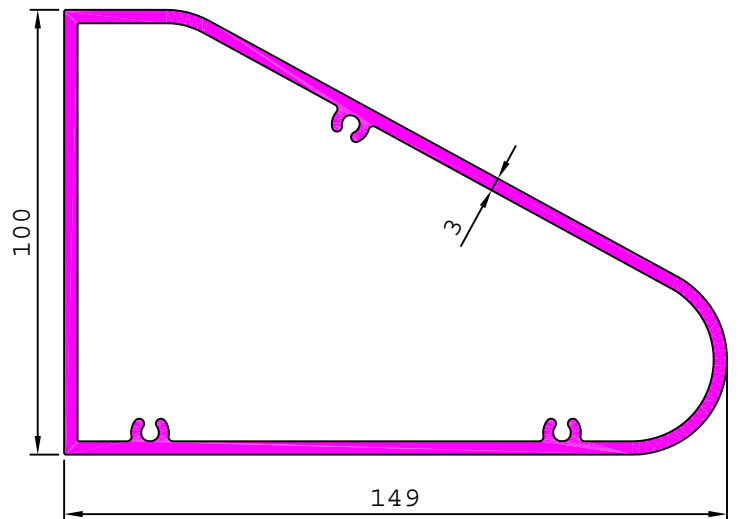

LOUVER SECTION

S6696

2.896 kg/m

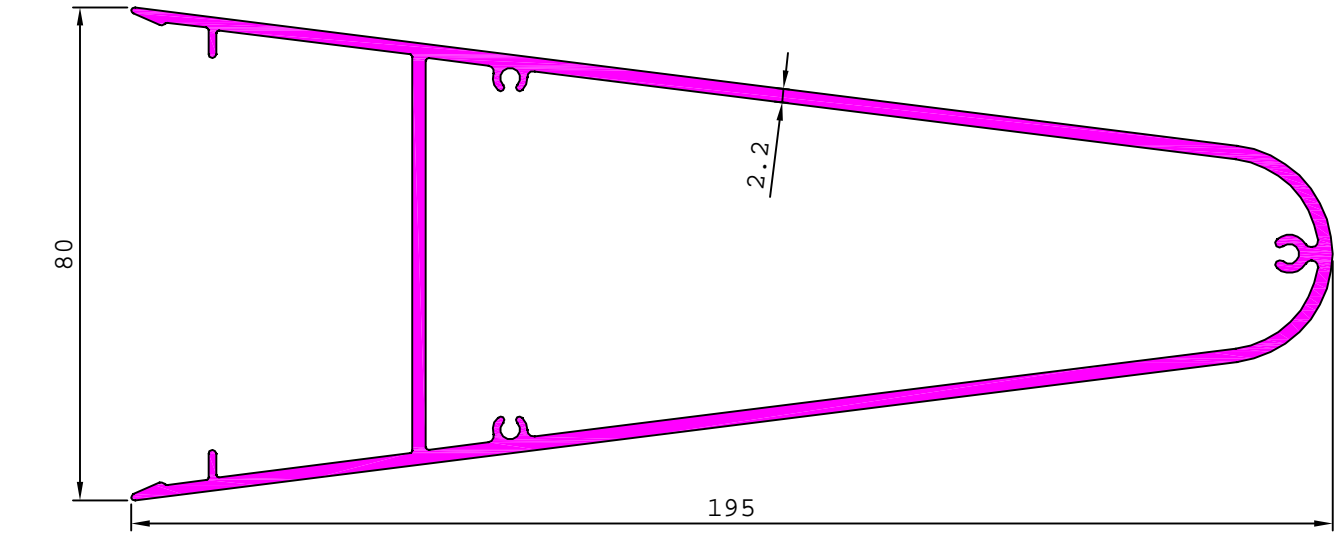

MATCHING WITH 22826

S6739

6.043 kg/m

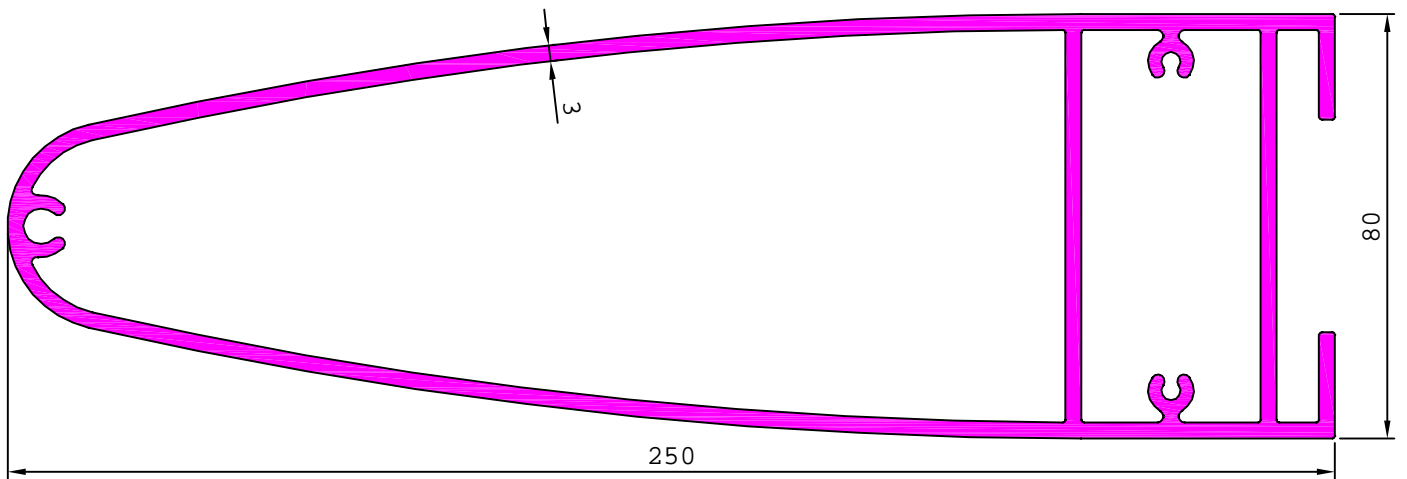

21944

4.103 kg/m

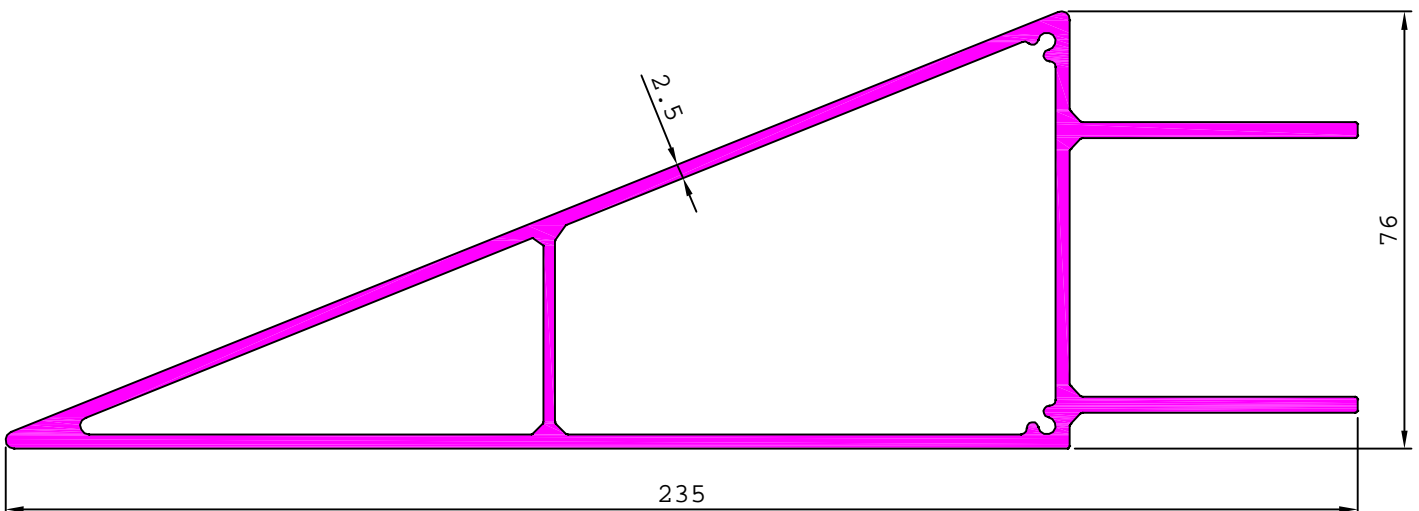

LOUVER SECTION

21921

1.811 kg/m

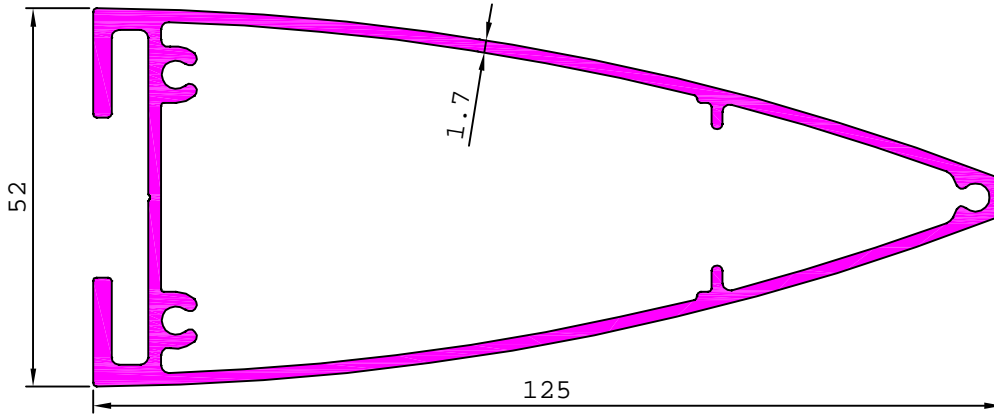

21741

0.532 kg/m

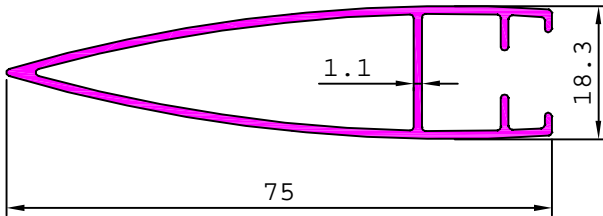

21793

0.893 kg/m

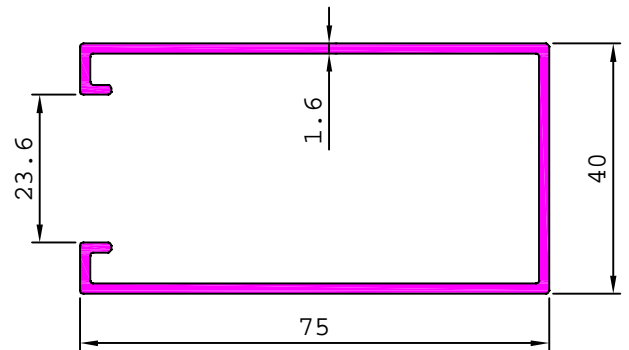

36232

7.050 kg/m

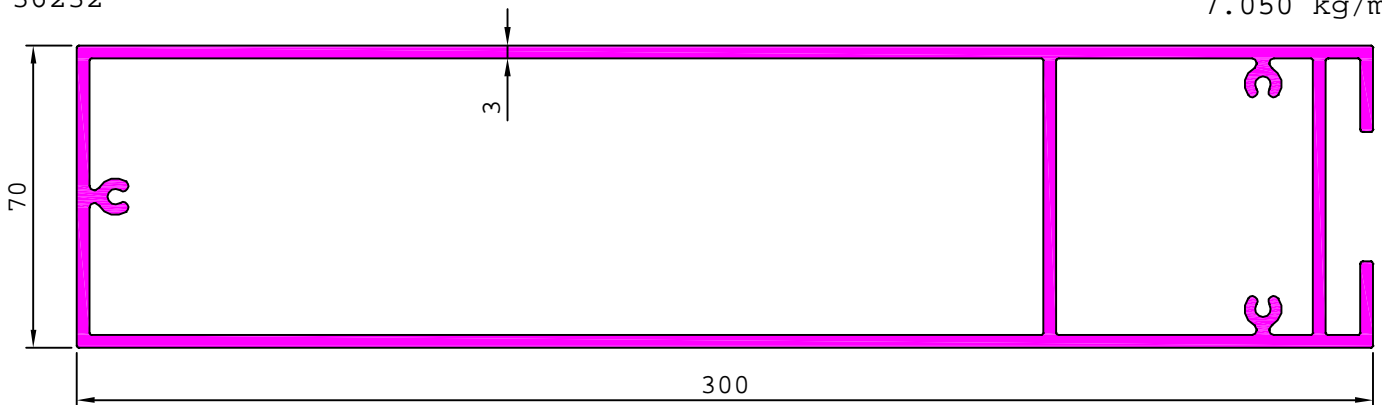

21734

1.492 kg/m

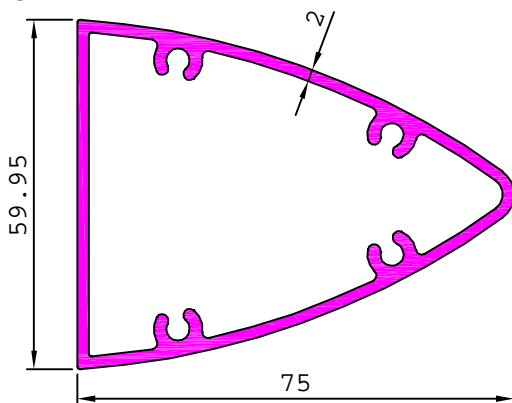

LOUVER SECTION

21835

3.334 kg/m

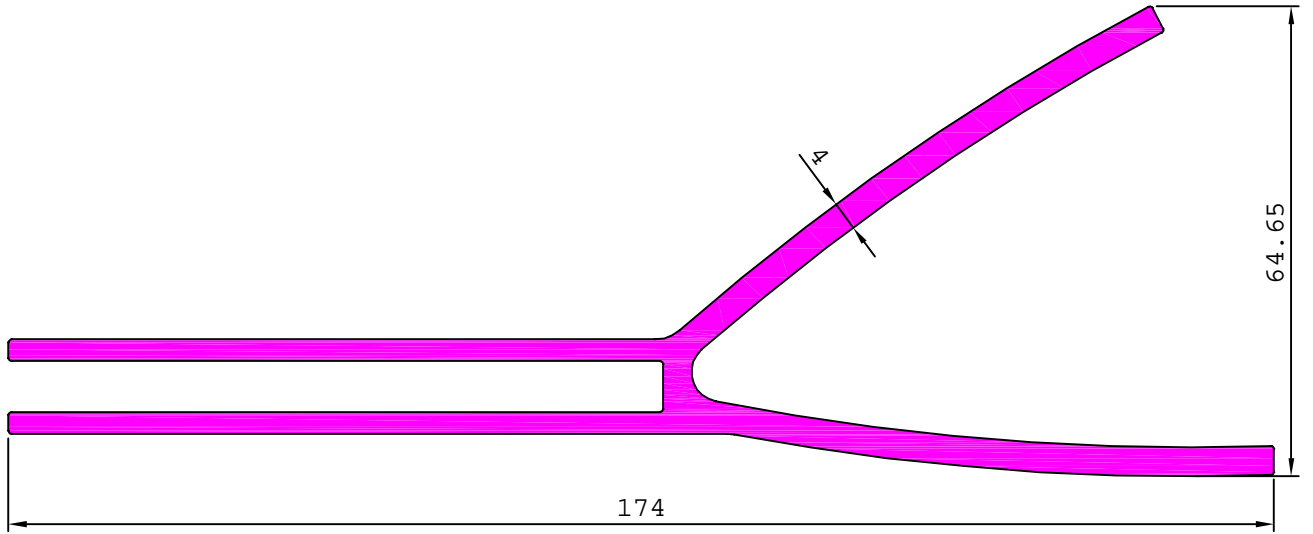

MATCHING WITH 21753

29330

3.243 kg/m

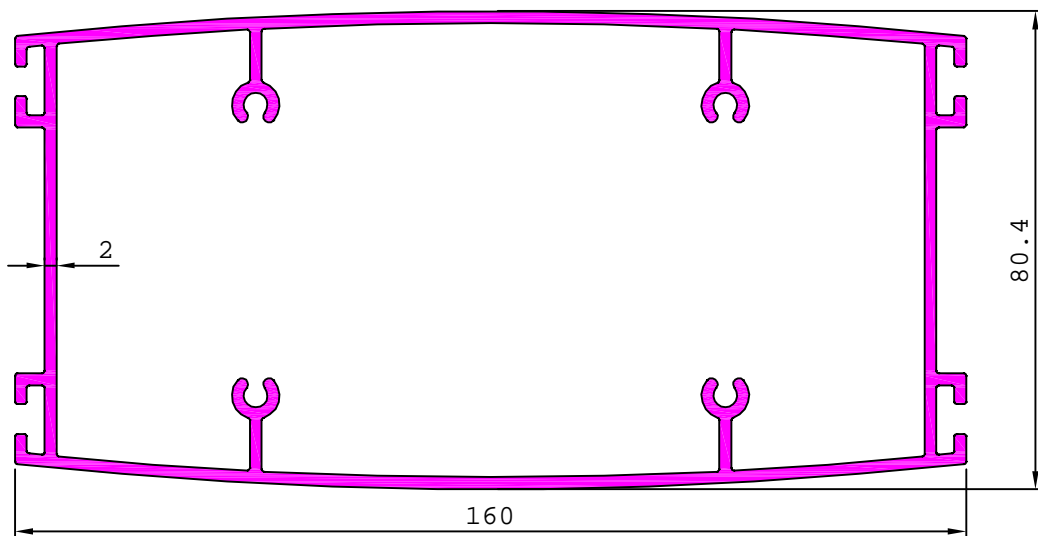

21993

1.087 kg/m

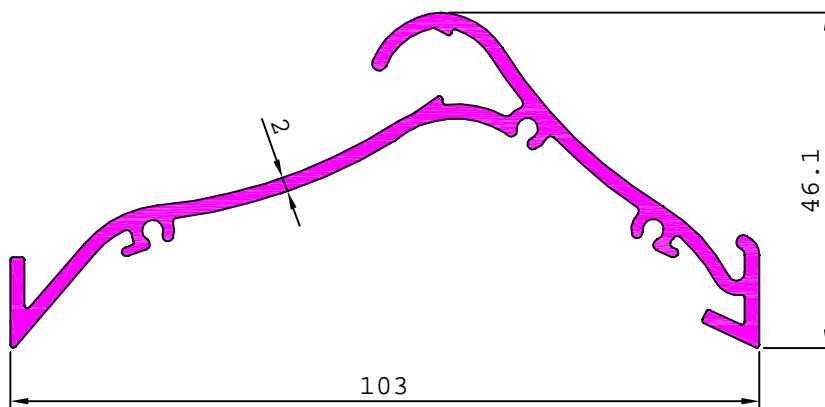

LOUVER SECTION

21639

0.854 kg/m

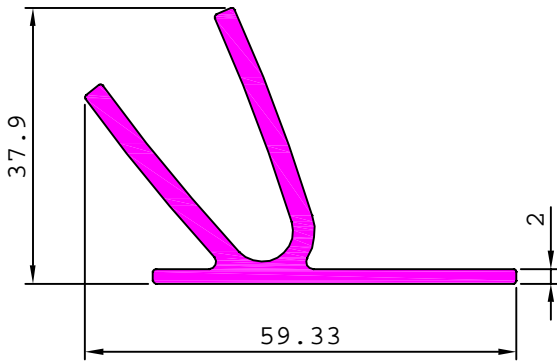

MATCHING WITH 21637

21719

1.048 kg/m

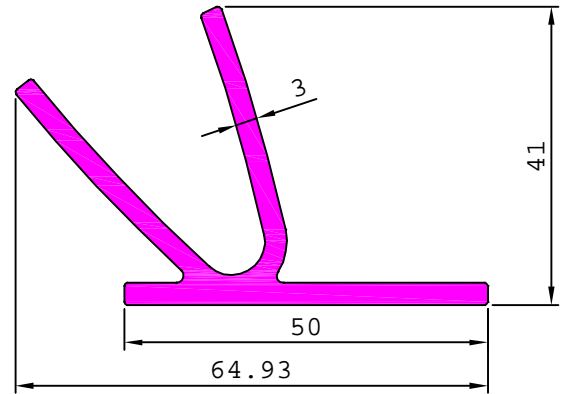

21720

1.129 kg/m

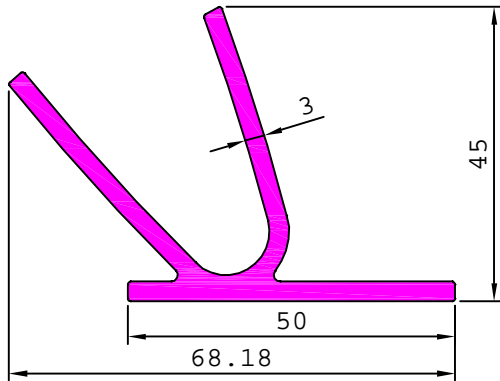

MATCHING WITH 29164

21927

1.170 kg/m

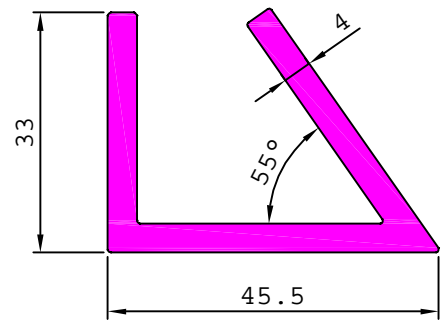

21420

0.947 kg/m

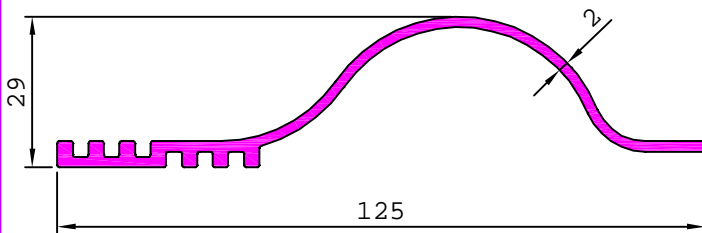

21421

0.728 kg/m

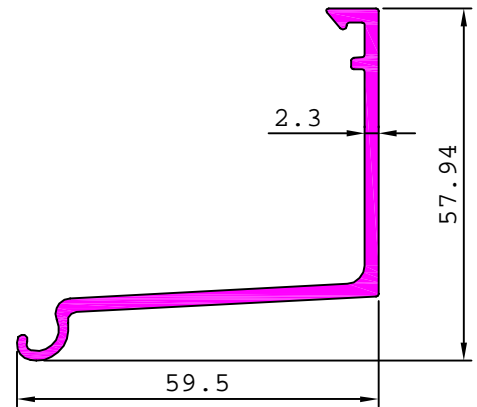

28973

0.462 kg/m

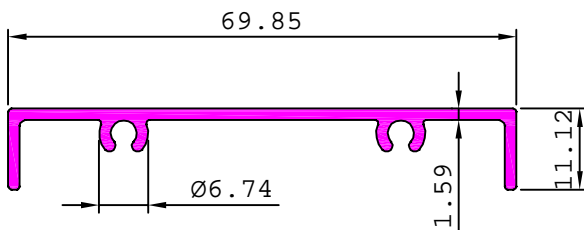

S6597

1.139 kg/m

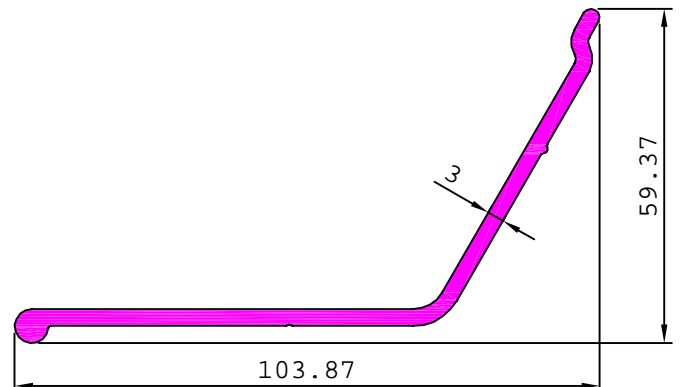

LOUVER SECTION

21712

1.267 kg/m

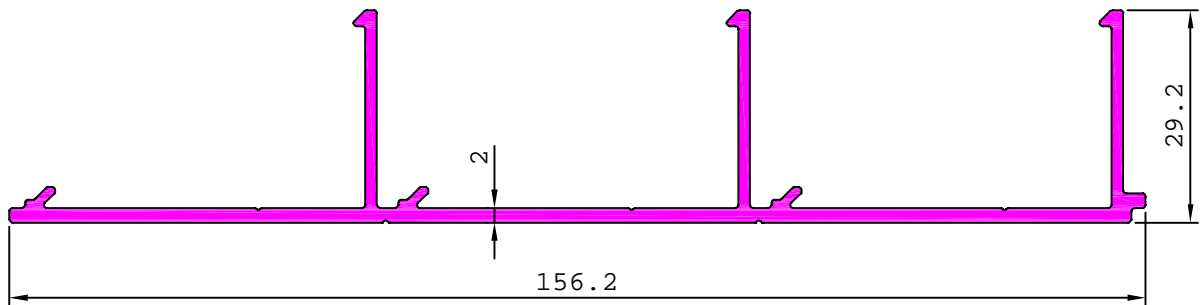

MATCHING WITH 21713

38684

0.504 kg/m

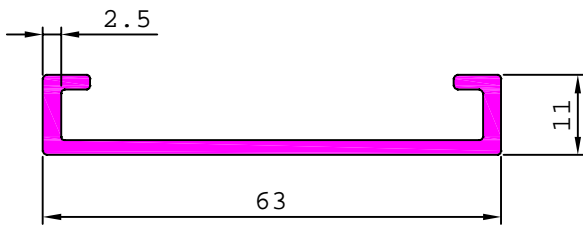

MATCHING WITH 38685

38685

0.767 kg/m

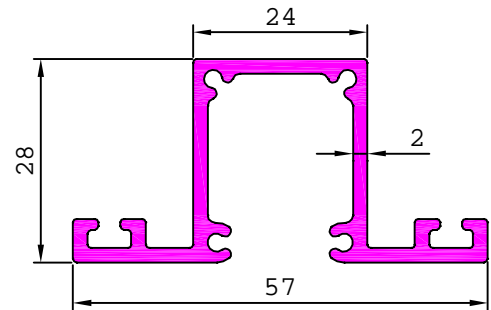

MATCHING WITH 38684

G104097

0.394 kg/m

