



## **INDEX**

**SILDING WINDOW 27 MM SERIES(Domal)**  
**SILDING WINDOW 18 MM SERIES**  
**SILDING WINDOW 35 MM SERIES(Domal)**  
**CASEMENT WINDOW 40 MM SERIES(Domal)**  
**CASEMENT WINDOW 40 MM SLEEK SERIES**  
**SILDING WINDOW 52 MM SERIES**  
**CURTAIN WALL 67 MM SERIES**  
**CURTAIN WALL 57MM SERIES**  
**CASEMENT WINDOW 44 MM SERIES**  
**DOOR & WINDOW 45 MM SERIES**  
**DOOR SECTIONS**  
**LOUVER SECTIONS**

## **WEIGHT:**

THE WEIGHTS KG/M GIVEN IN CATALOGUE ARE THE NOMINAL WEIGHTS. IN PRACTICE, TOLERANCE, ALLOY AND SUCH OTHER FACTORS WILL AFFECT THE FINAL WEIGHT AND A NORMAL VARIATION OF + OR - 10% SHOULD BE EXPECTED.

## SILDING WINDOW 27 MM SERIES (Domal)

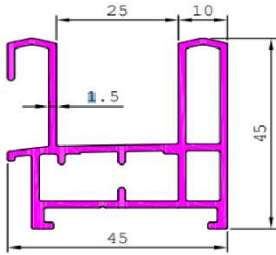

Section	PS-27501
Weight kg/m	1.004 Kg/m
Weight 15'	4.59 Kg

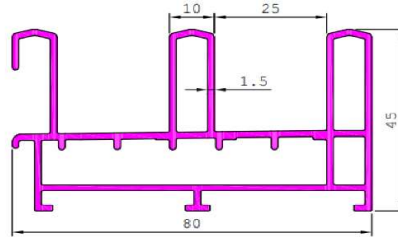

Section No	PS-27502
Weight kg/m	1.555 kg/m
Weight 15'	7.11 Kg

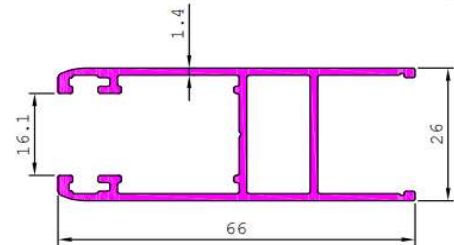

Section	PS-27503
Weight kg/m	0.774 kg/m
Weight 15'	3.54 Kg

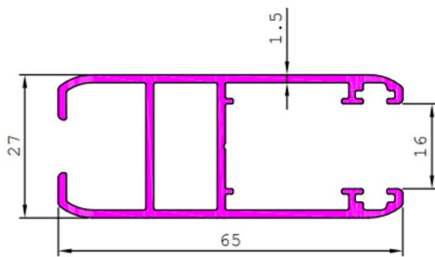

Section	PS-27504
Weight kg/m	0.851 Kg/m
Weight 15'	3.89 Kg

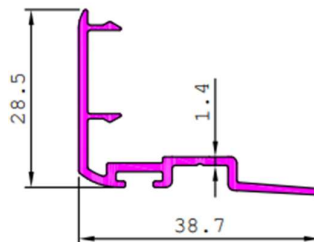

Section	PS-27505
Weight kg/m	0.303 Kg/m
Weight 15'	1.39 Kg

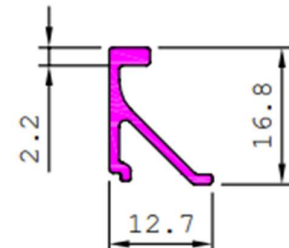

Section	PS-27506
Weight kg/m	0.133 Kg/m
Weight 15'	0.61 Kg

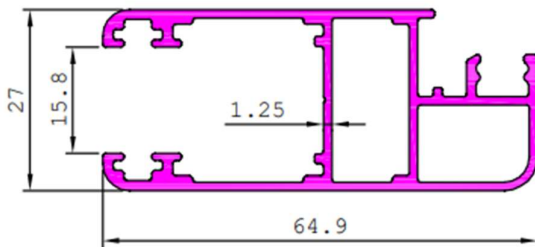

Section	PS-27507
Weight kg/m	0.875 Kg/m
Weight 15'	4.00 Kg

## SILDING WINDOW 18 MM SERIES

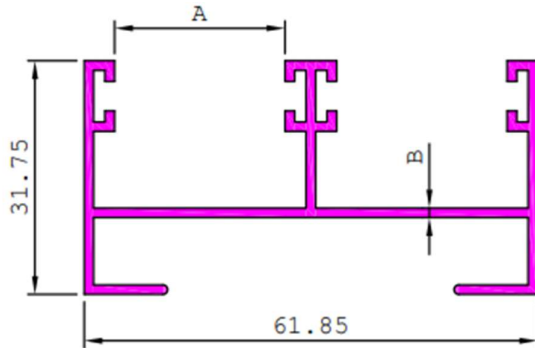

Section	PS-18501
Weight kg/m	0.659 Kg/m
Weight 15'	3.01 Kg

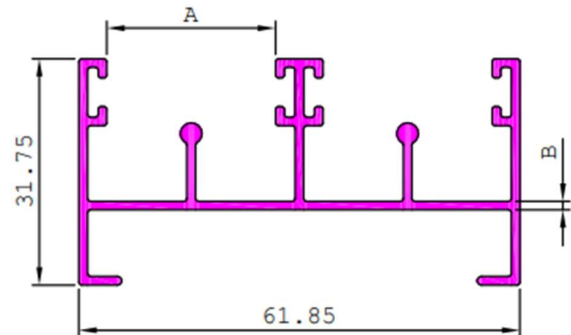

Section	PS-18502
Weight kg/m	0.695 Kg/m
Weight 15'	3.18 Kg

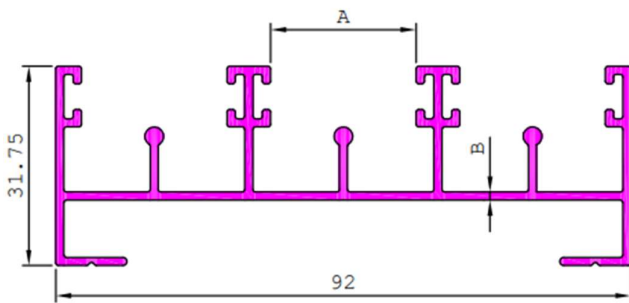

Section	PS-18503
Weight kg/m	1.065 Kg/m
Weight 15'	4.87 Kg

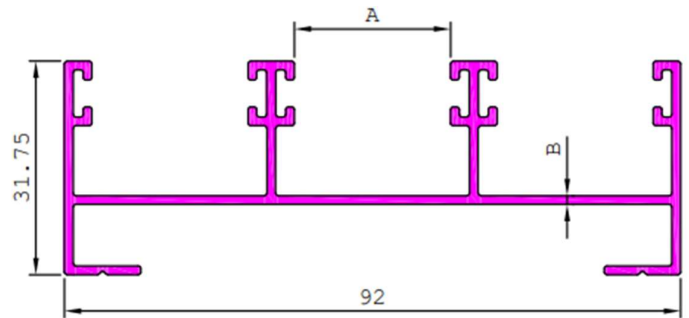

Section	PS-18504
Weight kg/m	0.929 Kg/m
Weight 15'	4.25 Kg

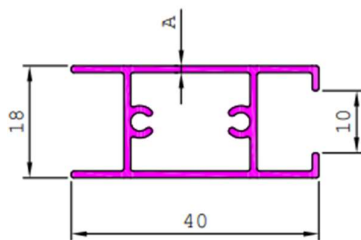

Name	PS-18505
Weight kg/m	0.547
Weight 15'	2.50 Kg

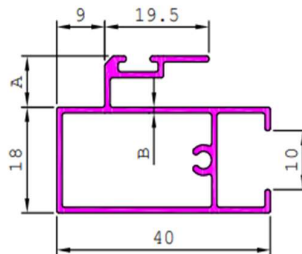

Section	PS-18506
Weight kg/m	0.607Kg/m
Weight 15'	2.78 Kg

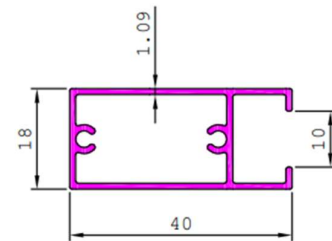

Section	PS-18507
Weight kg/m	0.547 Kg/m
Weight 15'	2.50 Kg

## SILDING WINDOW 35 MM SERIES (Domal)

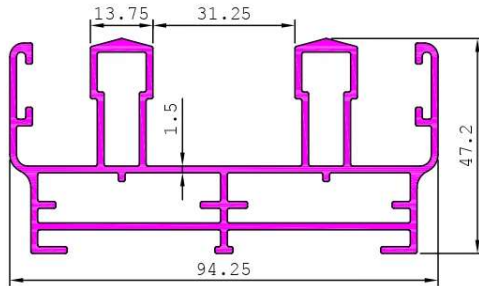

Section	PS-35501
Weight kg/m	1.972 Kg/m
Weight 15'	9.02 Kg

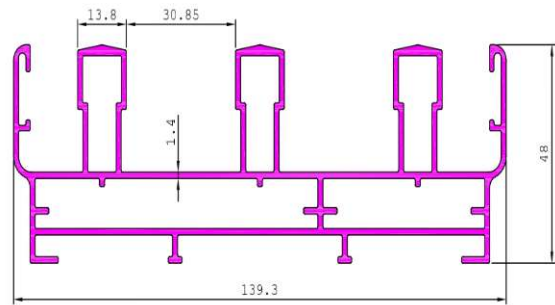

Section	PS-35502
Weight kg/m	2.480 Kg/m
Weight 15'	11.34 Kg

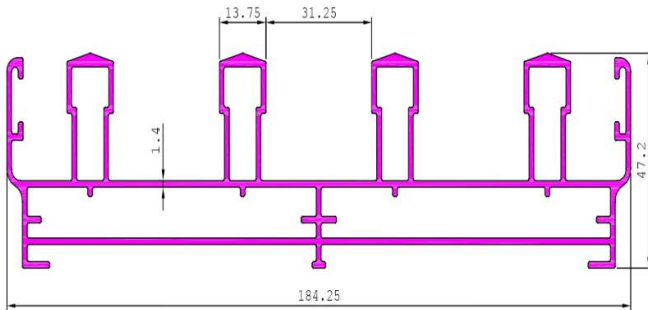

Section	PS-35503
Weight kg/m	3.109 Kg/m
Weight 15'	14.22 Kg

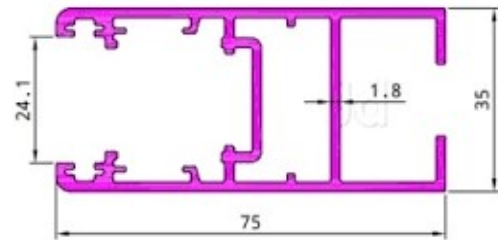

Section	PS-35504
Weight kg/m	1.385 Kg/m
Weight 15'	6.33 Kg

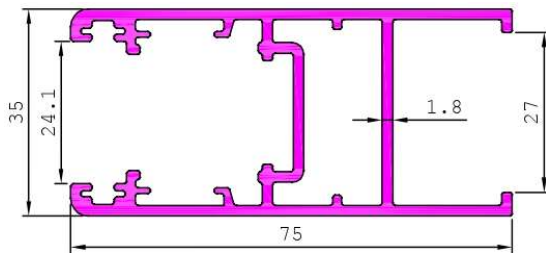

Section	PS-35505
Weight kg/m	1.319 Kg/m
Weight 15'	6.03 Kg

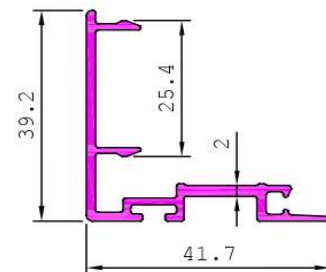

Section	PS-35506
Weight kg/m	0.468 Kg/m
Weight 15'	2.14 Kg

## CASEMENT WINDOW 40 MM SERIES (Domal)

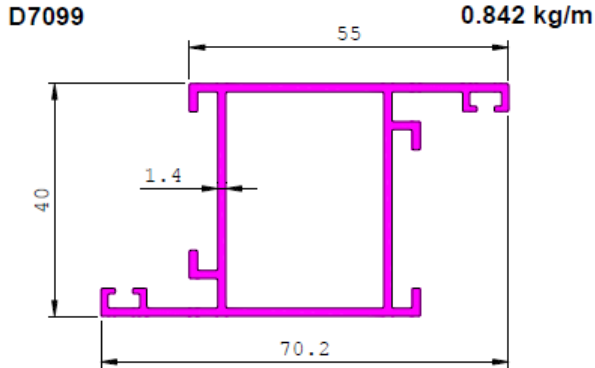

Section	D7099
Weight kg/m	0.842 Kg/m
Weight 15'	3.85 Kg

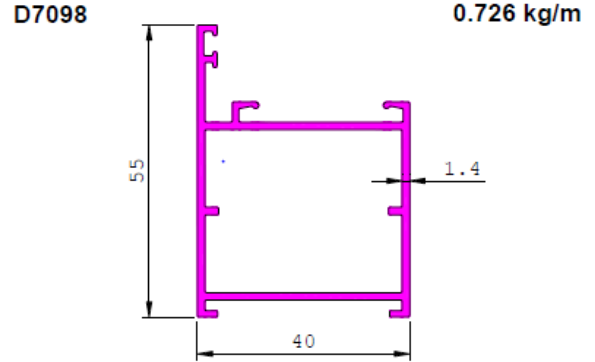

Section	D7098
Weight kg/m	0.726 Kg/m
Weight 15'	3.32 Kg

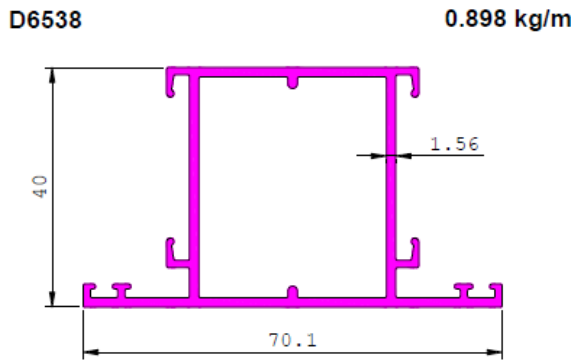

Section	D6538
Weight kg/m	0.898 Kg/m
Weight 15'	4.11 Kg

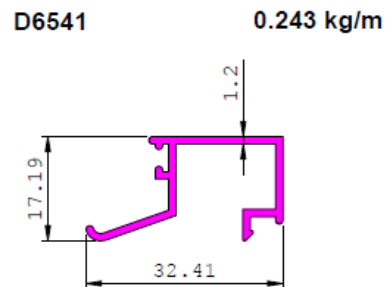

Section	D6541
Weight kg/m	0.243 Kg/m
Weight 15'	1.11 Kg

## CASEMENT WINDOW 40 MM SLEEK SERIES

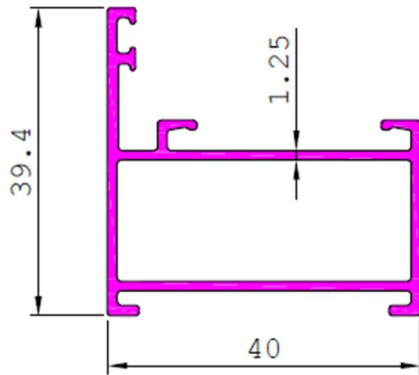

Section	S5180
Weight kg/m	0.550 Kg/m
Weight 15'	2.52 Kg

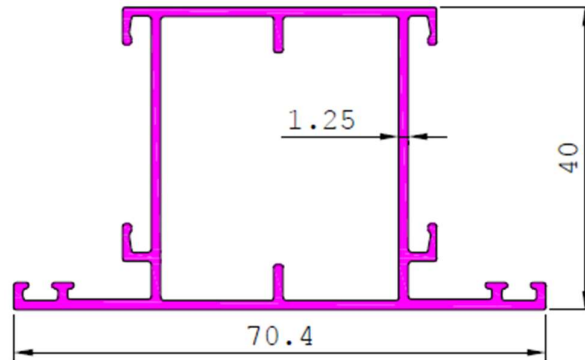

Section	S5181
Weight kg/m	0.782 Kg/m
Weight 15'	3.58 Kg

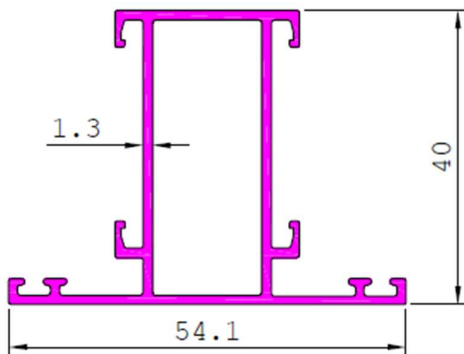

Section	21801
Weight kg/m	0.648 Kg/m
Weight 15'	2.96 Kg

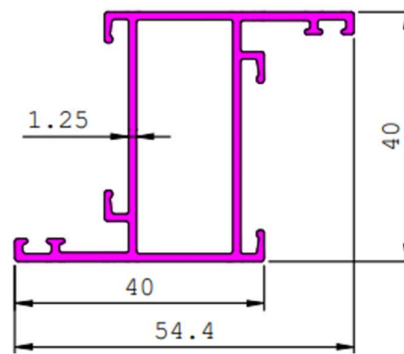

Section	G101573
Weight kg/m	0.641 Kg/m
Weight 15'	2.93 Kg

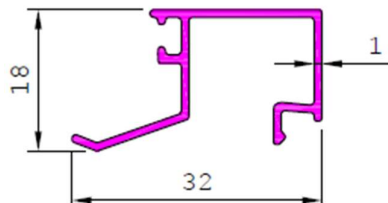

Section	S5179
Weight kg/m	0.210
Weight 15'	0.96 Kg

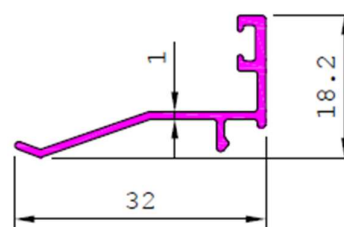

Section	41541
Weight kg/m	0.161 Kg/m
Weight 15'	0.74 Kg

## CASEMENT WINDOW 52 MM SERIES

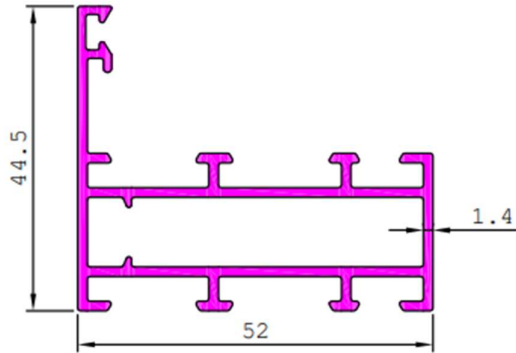

Section	PS-52501
Weight kg/m	0.842 Kg/m
Weight 15'	3.85 Kg

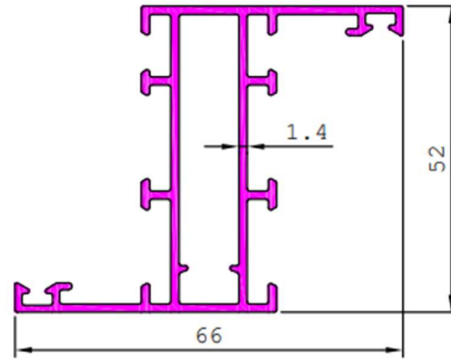

Section	PS-52502
Weight kg/m	0.956 Kg/m
Weight 15'	4.37 Kg

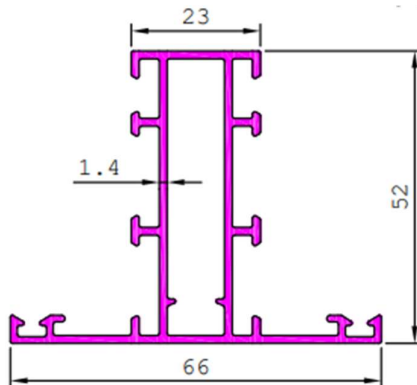

Section	PS-52503
Weight kg/m	0.956 Kg/m
Weight 15'	4.37 Kg

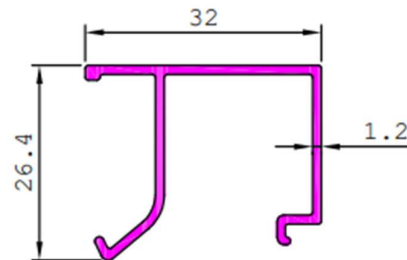

Section	PS-52504
Weight kg/m	0.297 Kg/m
Weight 15'	1.36 Kg

# Atco Aluminium Systems

Authorised Stocklist: JINDAL ALUMINIUM LTD.



Jindal Aluminium

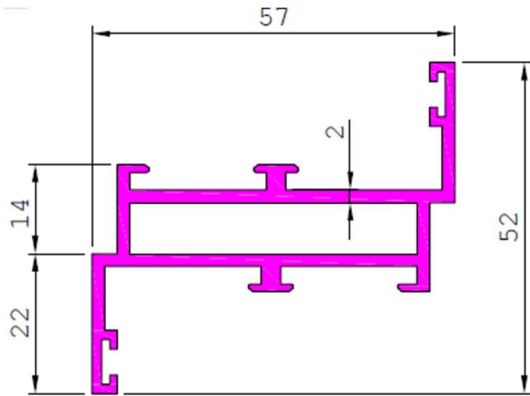

Section	PS-52505
Weight kg/m	1.065 Kg/m
Weight 15'	4.87 Kg

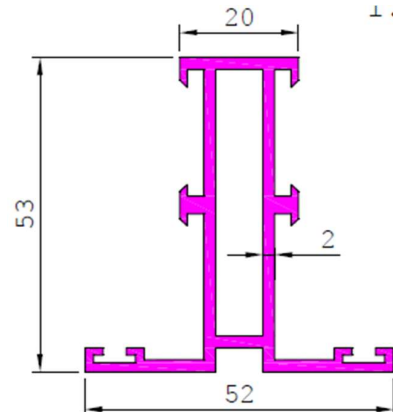

Section	PS-52506
Weight kg/m	1.065 Kg/m
Weight 15'	4.87 Kg

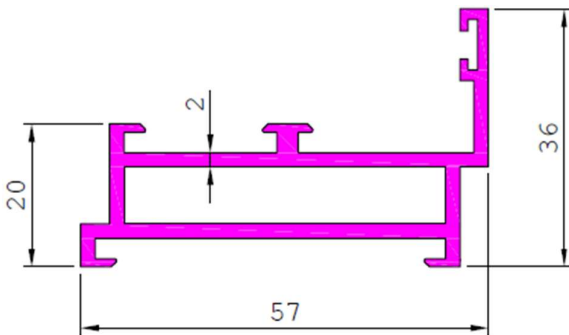

Section	PS-52507
Weight kg/m	0.918 Kg/m
Weight 15'	4.20 Kg

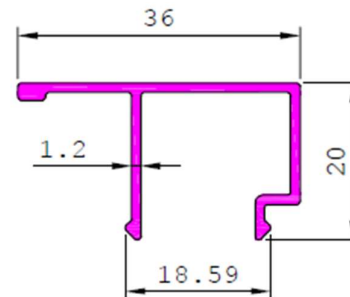

Section	PS-52508
Weight kg/m	0.266 Kg/m
Weight 15'	1.22 Kg

**ATCO ALUMINIUM SYSTEMS.**

Authorized Stockist: JINDAL ALUMINIUM LTD.

XV8994, 3/3, D.B Gupta Road, Paharganj, New Delhi-110055.

Phone: 011-49122499, 45122599

## CURTAIN WALL 67MM SERIES

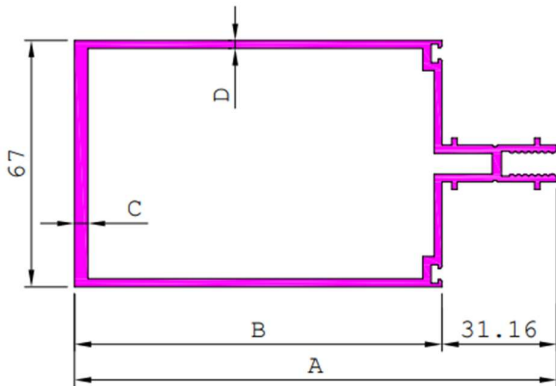

S No.	Section No	A	B	C	D	Wt/15ft
1	PS-67501	81.16	50	2	2	7.4kg
2	PS-67502	131.16	100	3.7	2.2	12kg

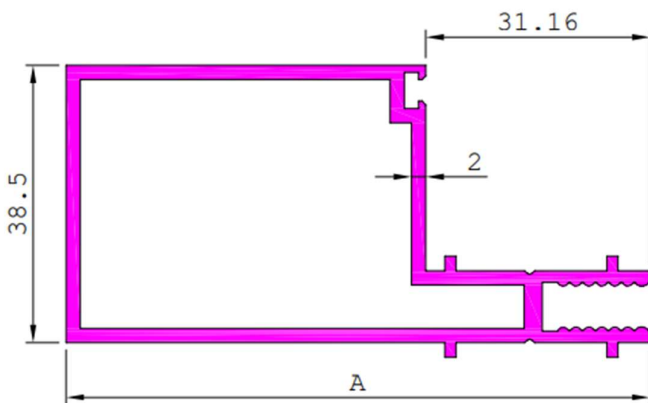

S No.	Section No	A	Wt/15ft
1	PS-67503	81.16	5.9kg
2	PS-67504	131.16	8.8kg

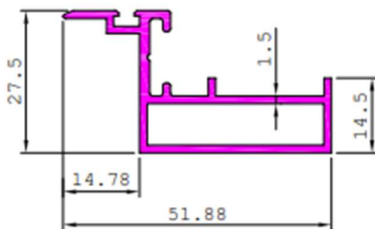

Section	PS-67505
Weight kg/m	0.586 Kg/m
Weight 15'	2.68 Kg

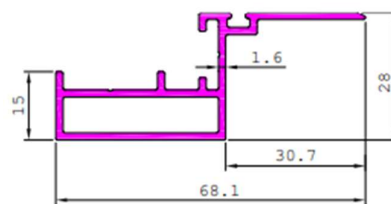

Section	PS-67506
Weight kg/m	0.693 Kg/m
Weight 15'	3.17 Kg

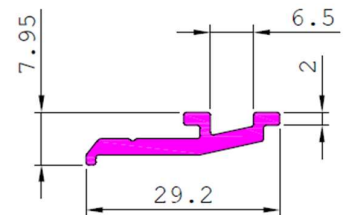

Section	PS-67507
Weight kg/m	0.230 Kg/m
Weight 15'	1.05 Kg

## CURTAIN WALL 57MM SERIES

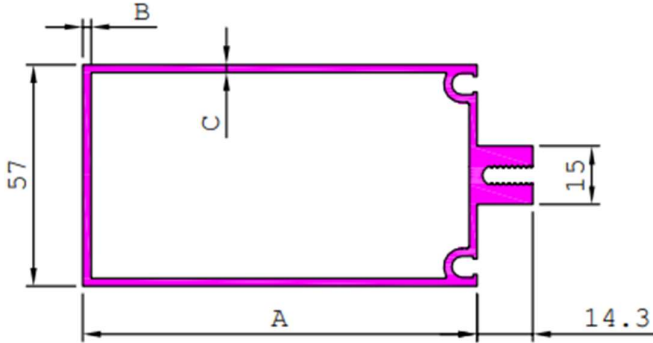

Section	PS-57501
Weight kg/m	2.187 Kg/m
Weight 15'	10.00 Kg
A	101.60
B	2.10
C	2.00

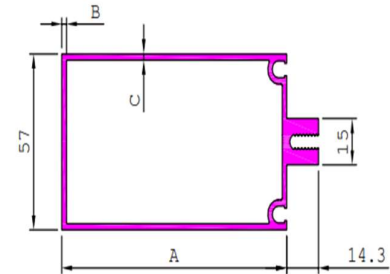

Section	PS-57502
Weight kg/m	1.777 Kg/m
Weight 15'	8.13 Kg
A	64.00
B	2.00
C	2.00

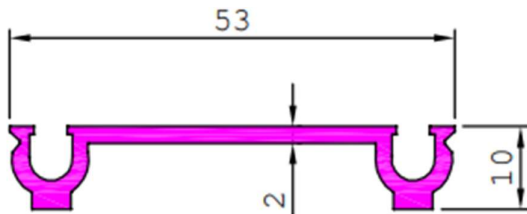

Section	PS-57503
Weight kg/m	0.434 Kg/m
Weight 15'	1.98 Kg

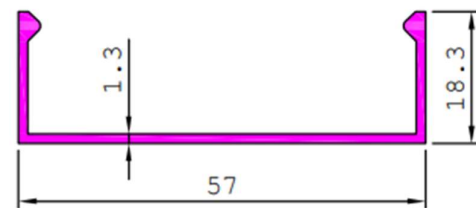

Section	PS-57504
Weight kg/m	0.343 Kg/m
Weight 15'	1.57 Kg

# Atco Aluminium Systems

Authorised Stocklist: JINDAL ALUMINIUM LTD.



Jindal Aluminium

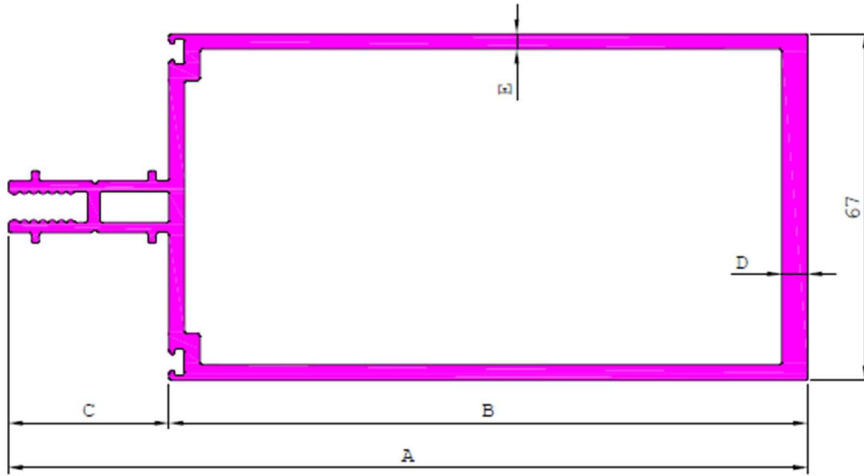

Section	PS-167508
Weight kg/m	3.929 Kg/m
Weight 15'	15.22 Kg

Section	PS-67509
Weight kg/m	0.693 Kg
Weight 15'	3.17 Kg

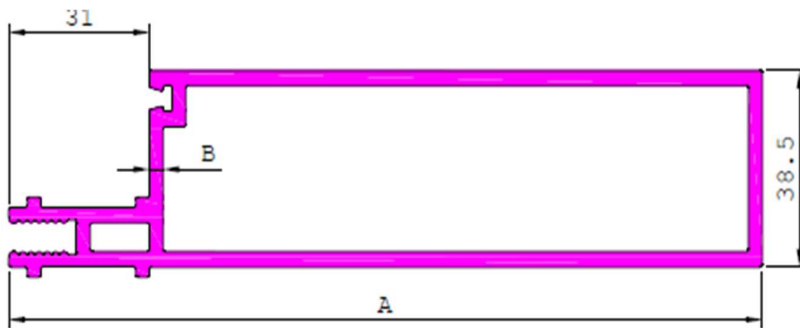
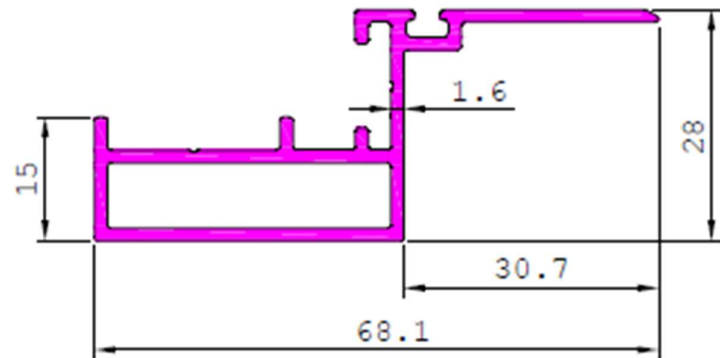

Section	PS-67510
Weight kg/m	3.361 Kg/m
Weight 15'	15.37 Kg

**ATCO ALUMINIUM SYSTEMS.**

Authorized Stockist: JINDAL ALUMINIUM LTD.

XV8994, 3/3, D.B Gupta Road, Paharganj, New Delhi-110055.

Phone: 011-49122499, 45122599

## DOOR & WINDOW 45 MM SERIES

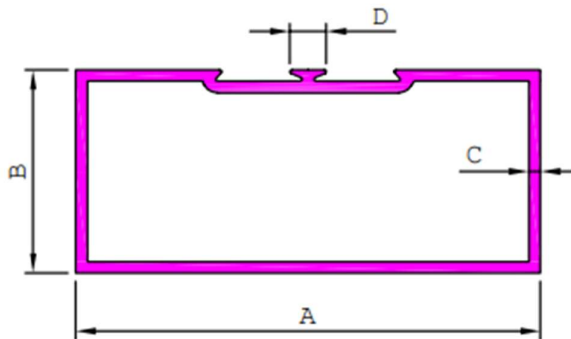

Section	PS-45501
Weight kg/m	0.818 Kg/m
Weight 15'	3.74 Kg
A	63.50
B	38.10
C	1.41
D	8

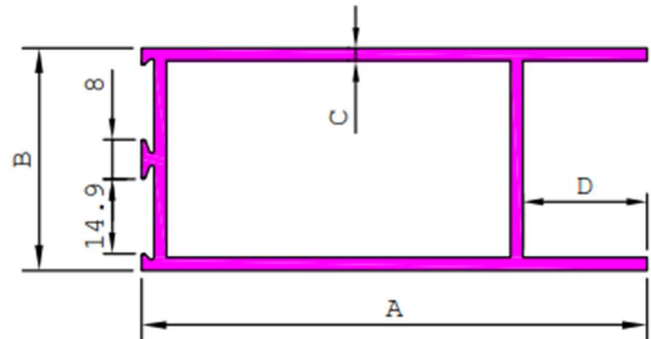

Section	PS-45502
Weight kg/m	1.302 Kg/m
Weight 15'	5.95 Kg
A	114.30
B	44.45
C	1.35
D	10.15

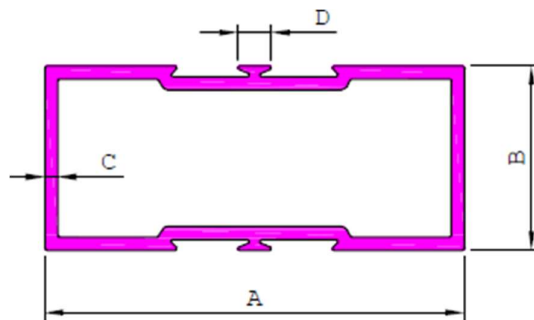

Section	PS-45503
Weight kg/m	0.942 Kg/m
Weight 15'	4.31 Kg
A	63.50
B	38.10
C	1.53
D	8.00

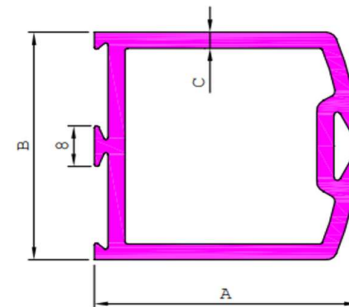

Section	PS-45504
Weight kg/m	1.417 Kg/m
Weight 15'	6.48 Kg
A	85
B	44.45
C	2

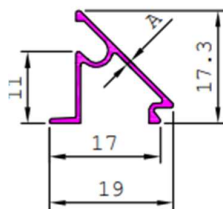

Section	PS-45505
Weight kg/m	0.071 Kg/m
Weight 15'	0.32 Kg
A	0.49

## DOOR SECTIONS

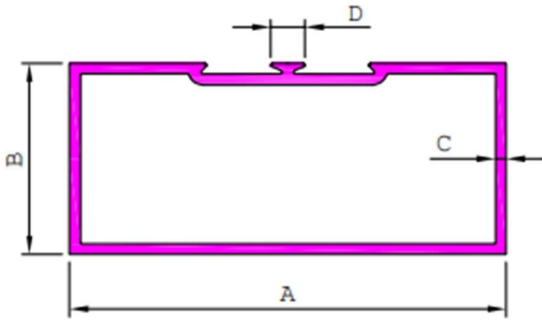

Section	PS-D501
Weight kg/m	2.343 Kg/m
Weight 15'	10.71 Kg
A	101.60
B	44.45
C	3
D	8

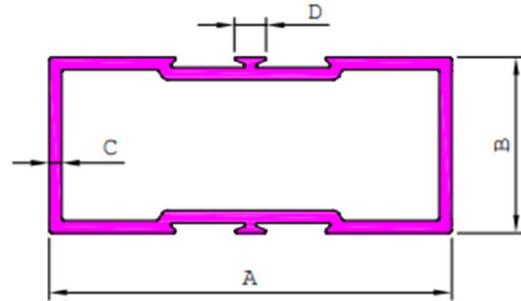

Section	PS-D502
Weight kg/m	2.415 Kg/m
Weight 15'	11.04 Kg
A	101.60
B	44.45
C	3
D	8

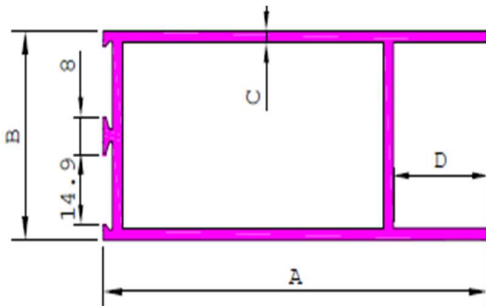

Section	PS-D503
Weight kg/m	1.843 Kg/m
Weight 15'	8.43 Kg
A	85.00
B	44.45
C	2.70
D	10

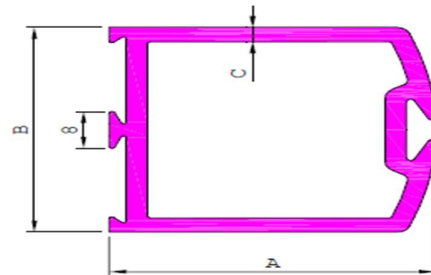

Section	PS-D504
Weight kg/m	2.050 Kg/m
Weight 15'	9.38 Kg
A	85.00
B	44.45
C	3.00

# Atco Aluminium Systems

Authorised Stocklist: JINDAL ALUMINIUM LTD.



Jindal Aluminium

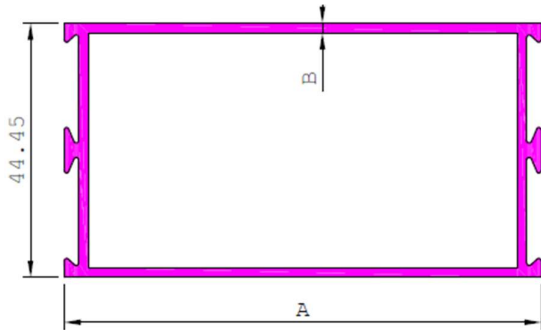

Section	PS-D505
Weight kg/m	2.145 Kg/m
Weight 15'	9.81 Kg
A	83.50
B	3.18

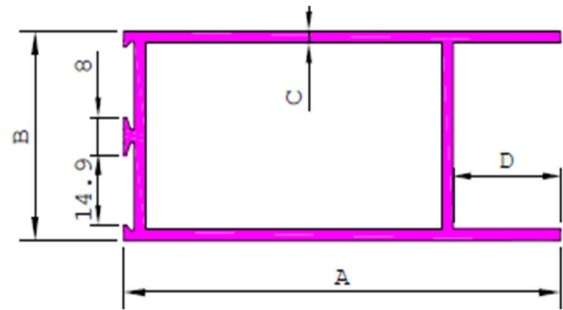

Section	PS-D506
Weight kg/m	3.181 Kg/m
Weight 15'	14.55 Kg
A	150.00
B	44.45
C	3.10
D	25.40

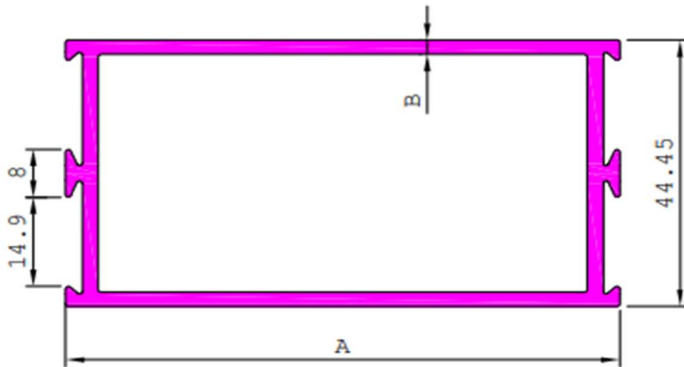

Section	PS-D507
Weight kg/m	2.779 Kg/m
Weight 15'	12.71 Kg
A	150.00
B	2.65

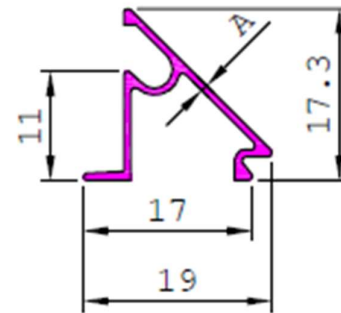

Section	PS-D508
Weight kg/m	0.124 Kg/m
Weight 15'	0.57 Kg
A	0.90

**ATCO ALUMINIUM SYSTEMS.**

Authorized Stockist: JINDAL ALUMINIUM LTD.

XV8994, 3/3, D.B Gupta Road, Paharganj, New Delhi-110055.

Phone: 011-49122499, 45122599

# Atco Aluminium Systems

Authorised Stocklist: JINDAL ALUMINIUM LTD.



Jindal Aluminium

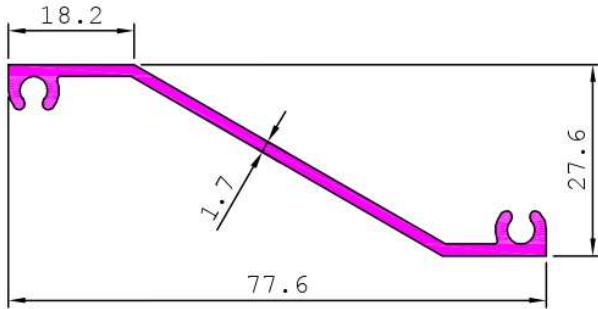

Section	PS-12501
Weight kg/m	0.483 Kg/m
Weight 15'	2.21 Kg

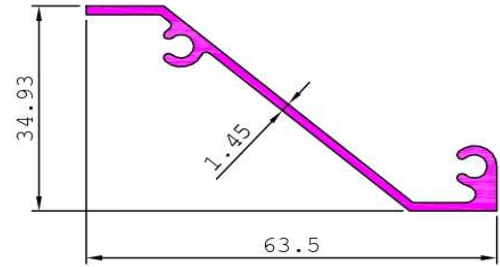

Section	PS-12502
Weight kg/m	0.429 Kg/m
Weight 15'	1.96 Kg

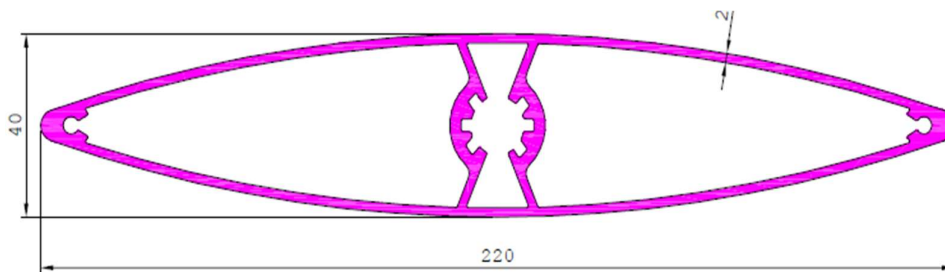

Section	PS-12503
Weight kg/m	3.228 Kg/m
Weight 15'	14.76 Kg

Section	PS-12504
Weight kg/m	1.086 Kg/m
Weight 15'	4.97 Kg

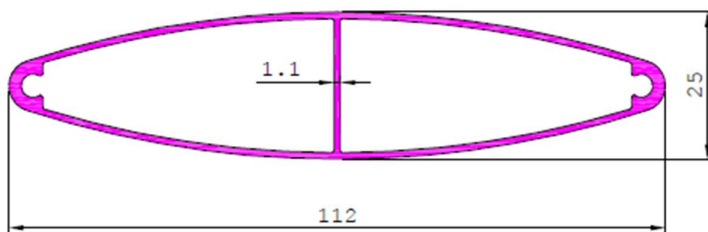
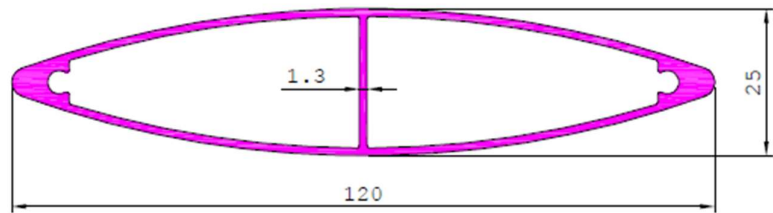

Section	PS-12505
Weight kg/m	0.843 Kg/m
Weight 15'	3.86 Kg

**ATCO ALUMINIUM SYSTEMS.**

Authorized Stockist: JINDAL ALUMINIUM LTD.

XV8994, 3/3, D.B Gupta Road, Paharganj, New Delhi-110055.

Phone: 011-49122499, 45122599

# Atco Aluminium Systems

Authorised Stocklist: JINDAL ALUMINIUM LTD.



Jindal Aluminium

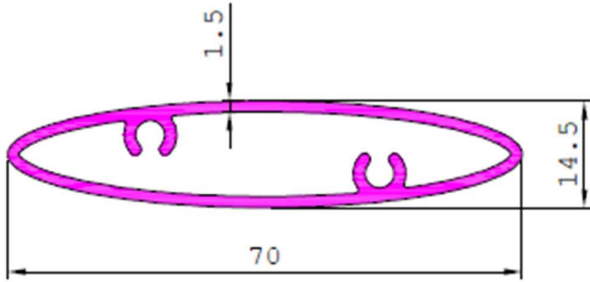

Section	PS-12506
Weight kg/m	0.678 Kg/m
Weight 15'	3.10 Kg



Section	PS-12507
Weight kg/m	0.706 Kg/m
Weight 15'	3.23 Kg

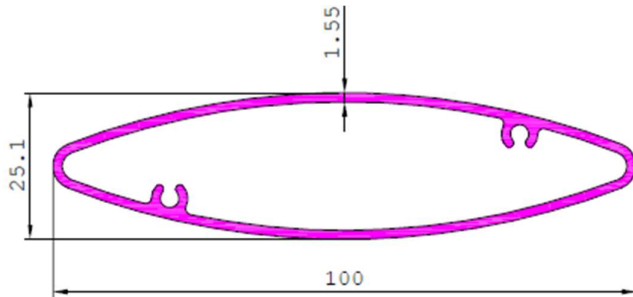

Section	PS-12508
Weight kg/m	0.954 Kg/m
Weight 15'	4.36 Kg

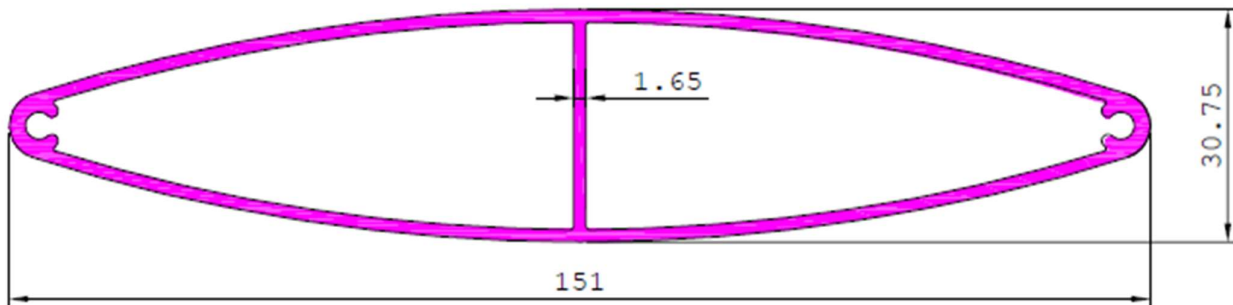

Section	PS-12509
Weight kg/m	1.573 Kg/m
Weight 15'	7.19 Kg

**ATCO ALUMINIUM SYSTEMS.**

Authorized Stockist: JINDAL ALUMINIUM LTD.

XV8994, 3/3, D.B Gupta Road, Paharganj, New Delhi-110055.

Phone: 011-49122499, 45122599

# Atco Aluminium Systems

Authorised Stocklist: JINDAL ALUMINIUM LTD.



Jindal Aluminium

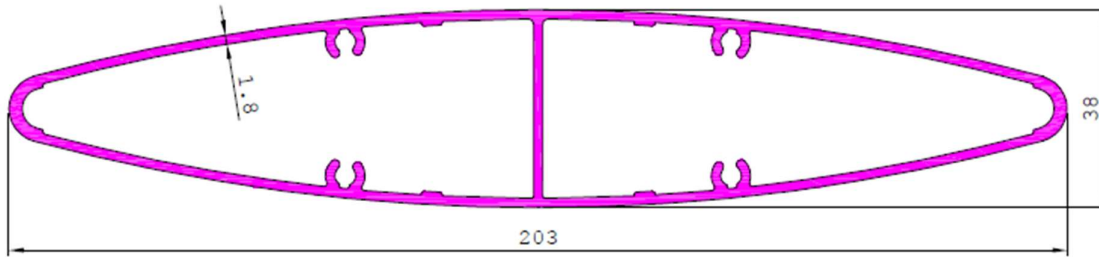

Section	PS-12510
Weight kg/m	2.511 Kg/m
Weight 15'	11.48 Kg

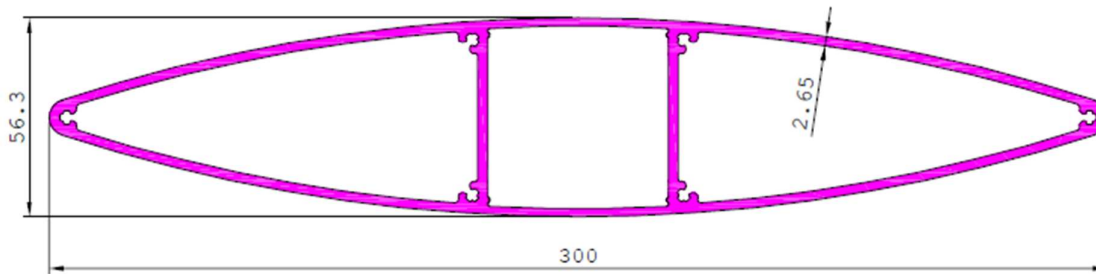

Section	PS-12511
Weight kg/m	5.293 Kg/m
Weight 15'	24.21 Kg

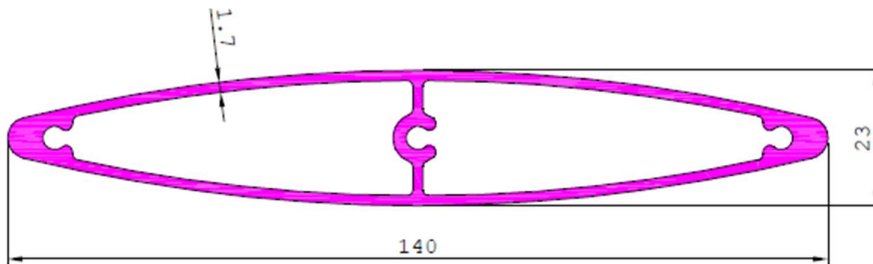

Section	PS-12512
Weight kg/m	1.624 Kg/m
Weight 15'	7.43 Kg

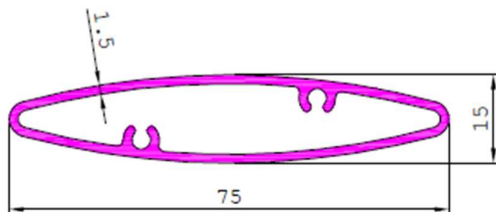

Section	PS-12513
Weight kg/m	0.693 Kg/m
Weight 15'	3.17 Kg

**ATCO ALUMINIUM SYSTEMS.**

Authorized Stockist: JINDAL ALUMINIUM LTD.

XV8994, 3/3, D.B Gupta Road, Paharganj, New Delhi-110055.

Phone: 011-49122499, 45122599

# Atco Aluminium Systems

Authorised Stocklist: JINDAL ALUMINIUM LTD.



Jindal Aluminium

---

---

**ATCO ALUMINIUM SYSTEMS.**

**Authorized Stockist: JINDAL ALUMINIUM LTD.**

**XV8994, 3/3, D.B Gupta Road, Paharganj, New Delhi-110055.**

**Phone: 011-49122499, 45122599**