

CONVEYOR SECTION

28606 3.856 kg/m

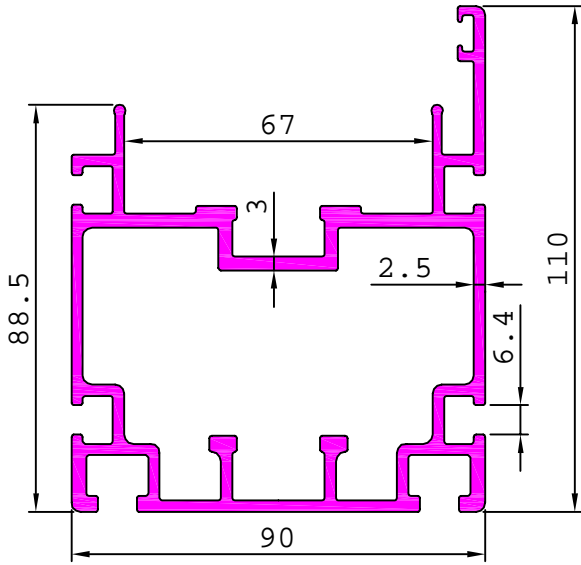

28609 3.615 kg/m

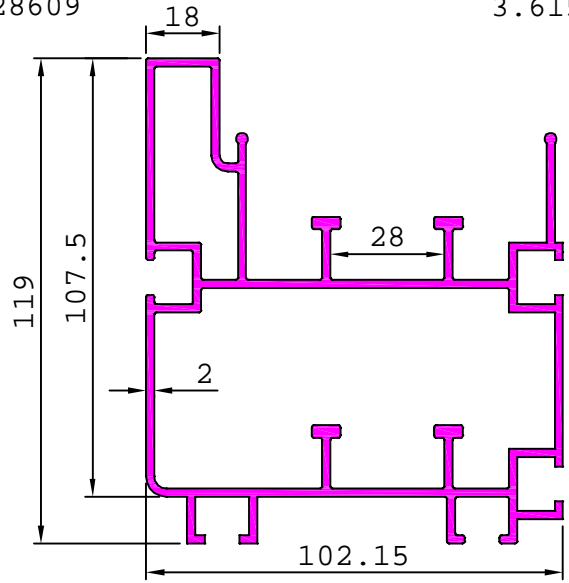

28678 6.175 kg/m

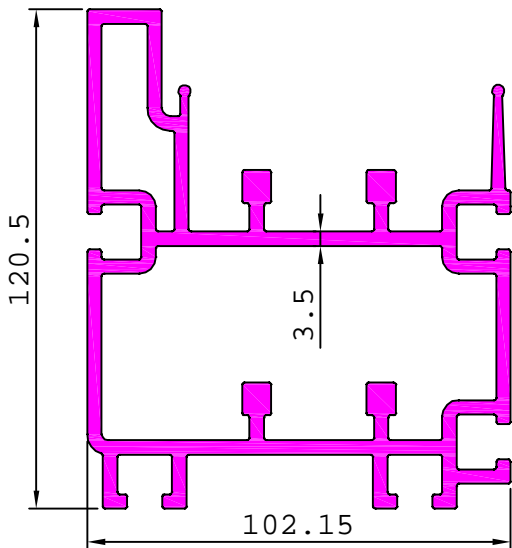

28626 6.119 kg/m

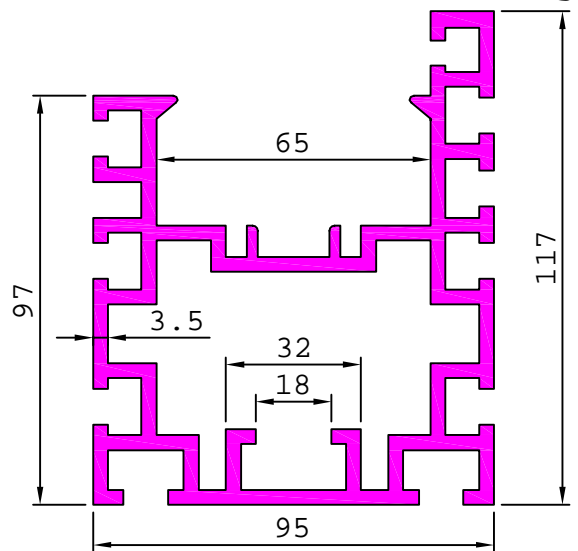

S6540 3.835 kg/m

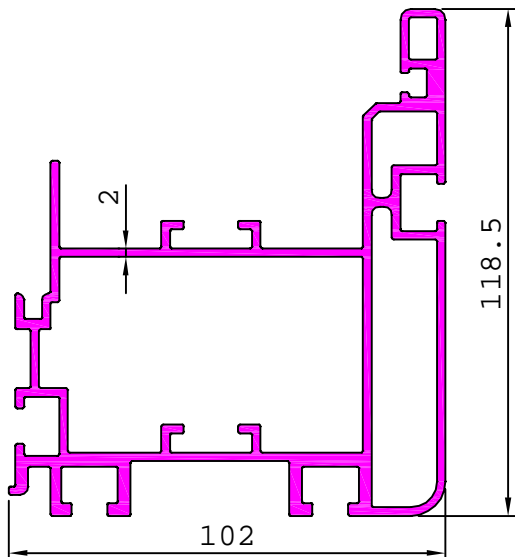

28680 6.197 kg/m

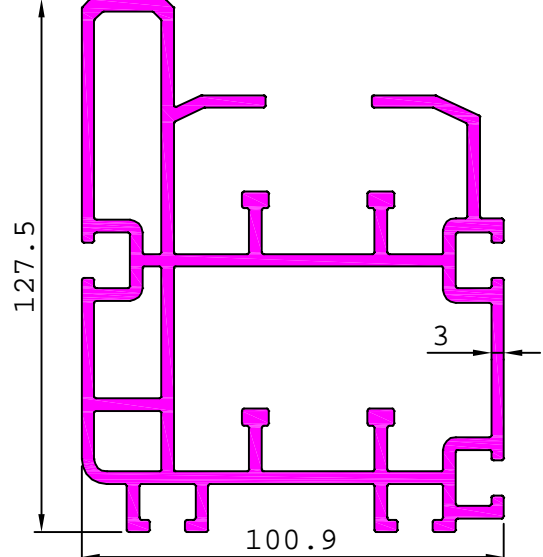

CONVEYOR SECTION

28639 7.483 kg/m

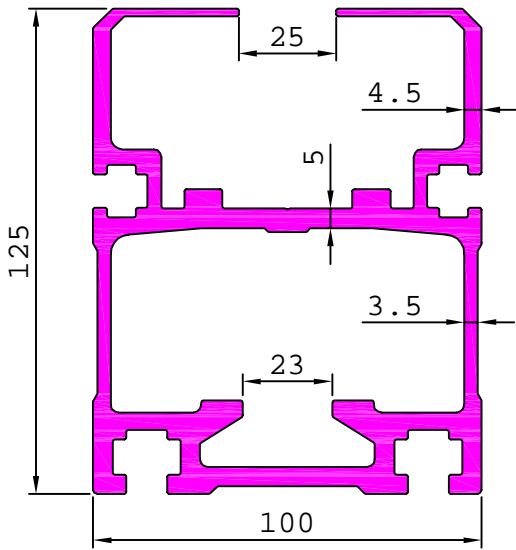

28640 4.480 kg/m

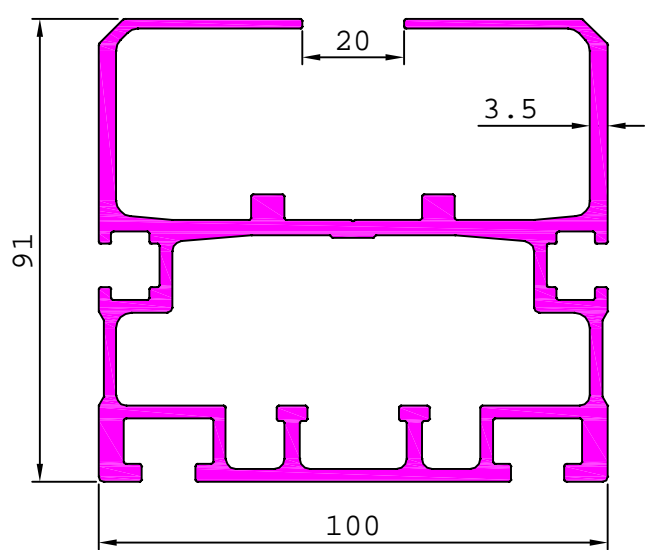

28645 3.677 kg/m

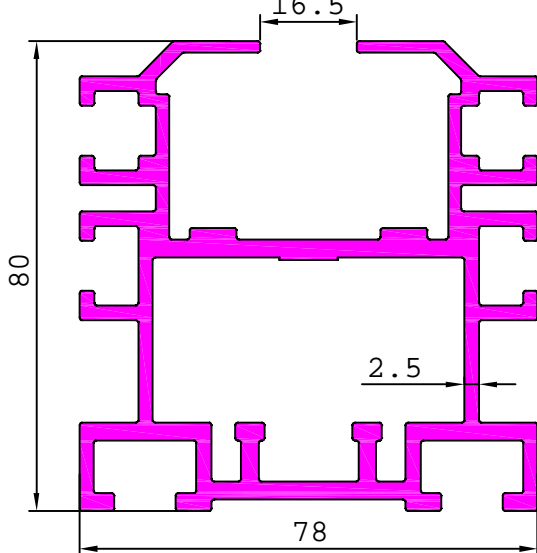

28674 4.523 kg/m

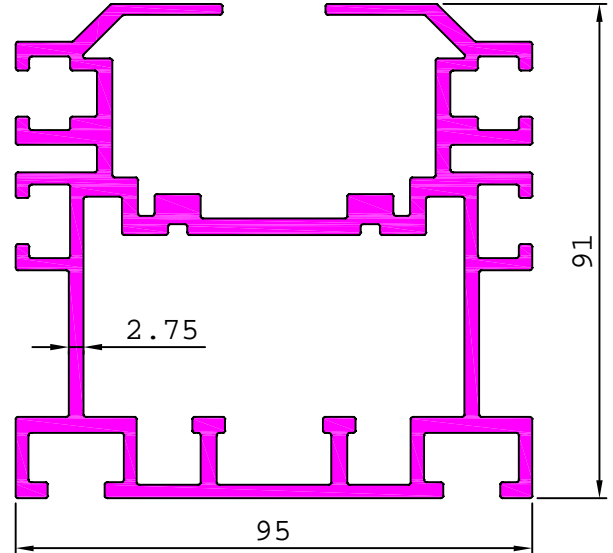

28662 11.236 kg/m

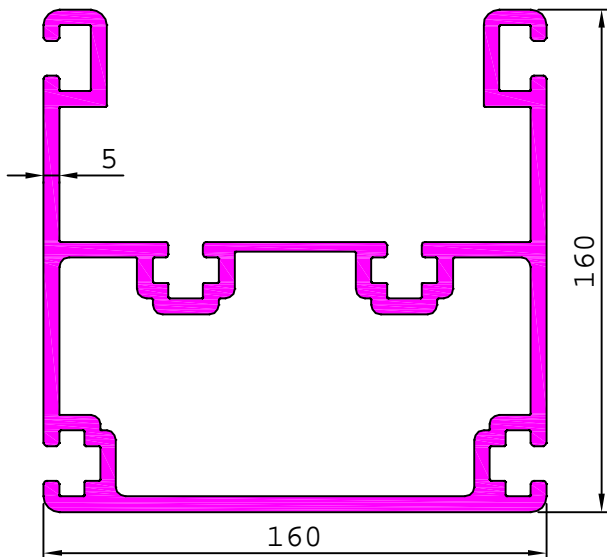

G101075 5.181 kg/m

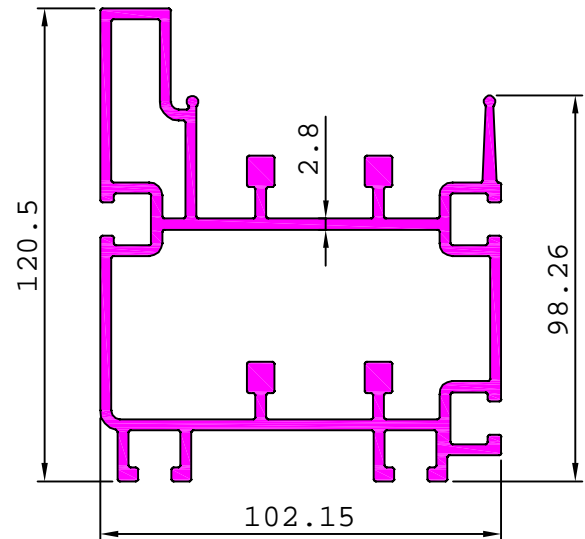

CONVEYOR SECTION

28601

0.532 kg/m

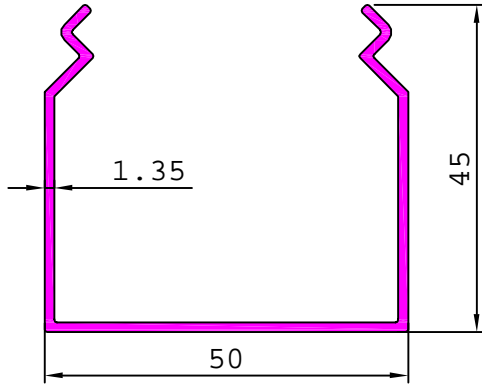

28602

0.284 kg/m

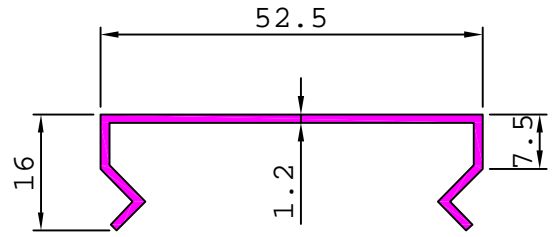

28603

3.495 kg/m

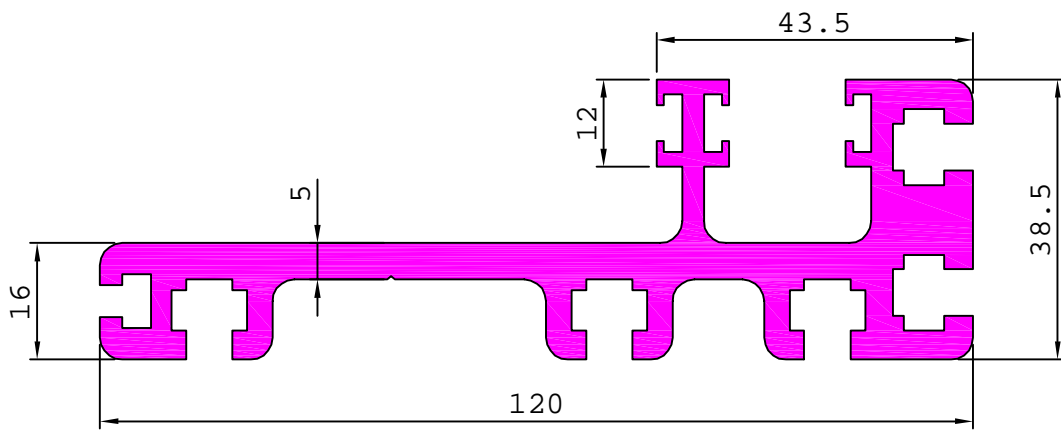

28604

1.394 kg/m

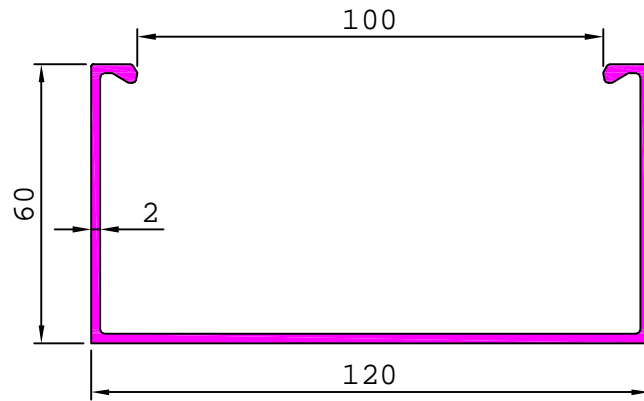

28605

0.830 kg/m

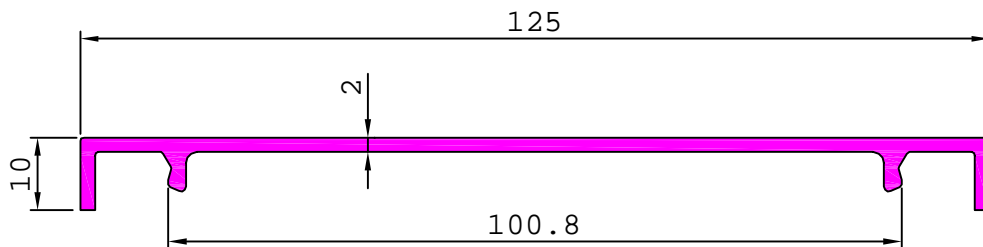

CONVEYOR SECTION

28608

3.057 kg/m

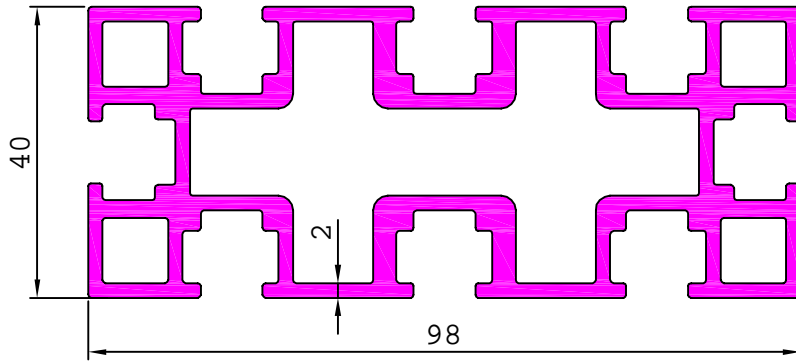

28611

3.096 kg/m

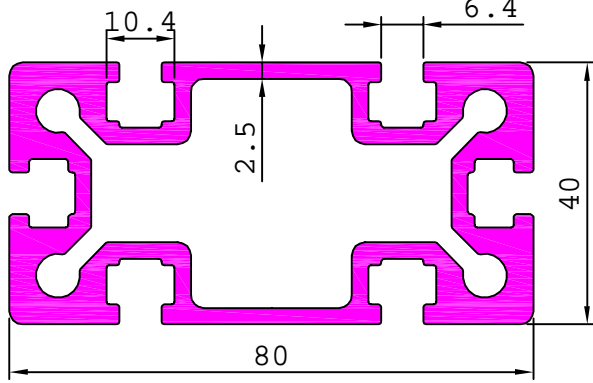

28612

1.298 kg/m

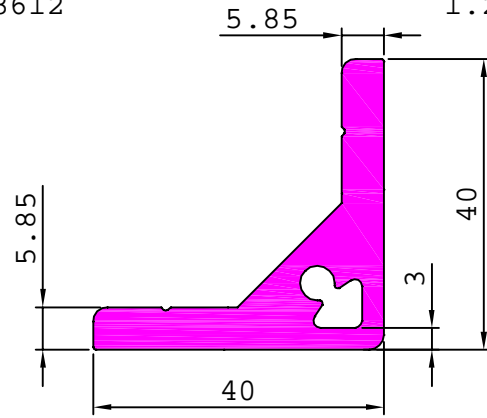

28614

4.300 kg/m

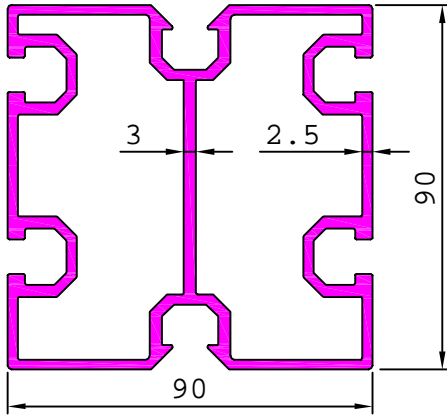

28615

5.360 kg/m

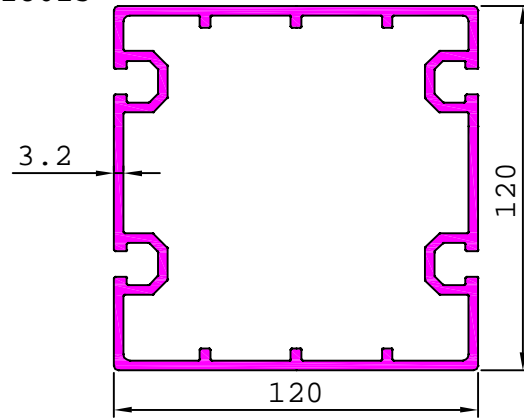

28623

6.493 kg/m

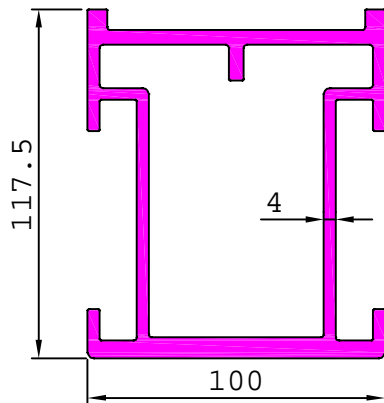

28627

4.094 kg/m

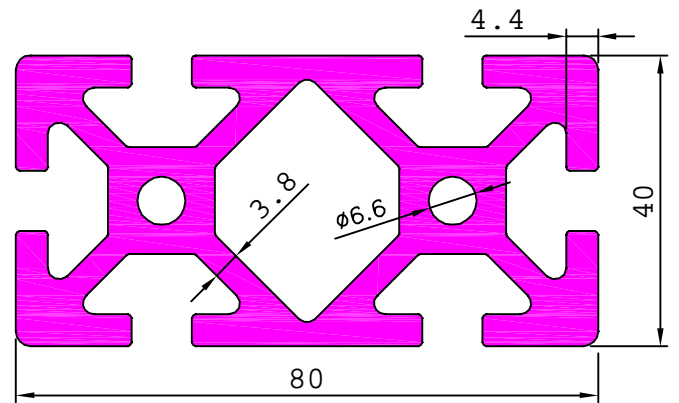

CONVEYOR SECTION

28619

1.506 kg/m

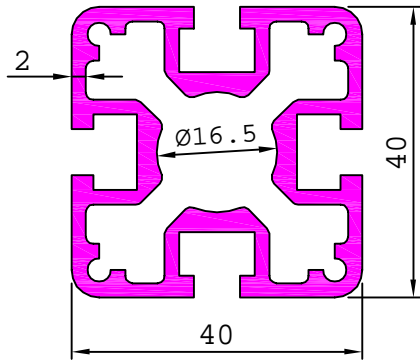

28620

1.070 kg/m

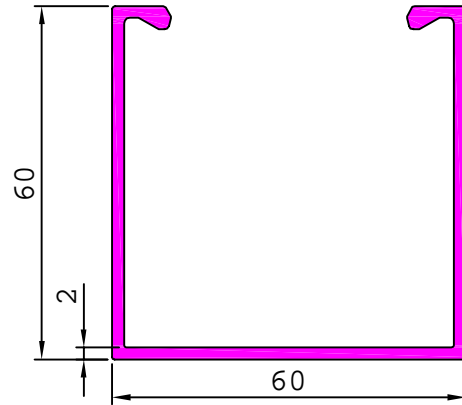

28618

1.733 kg/m

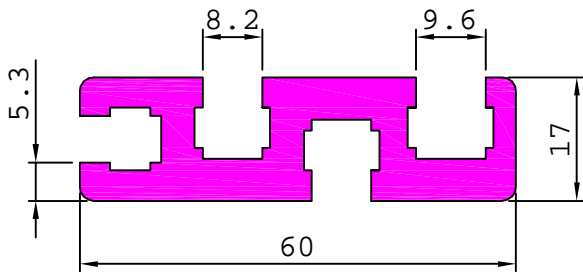

28637

0.986 kg/m

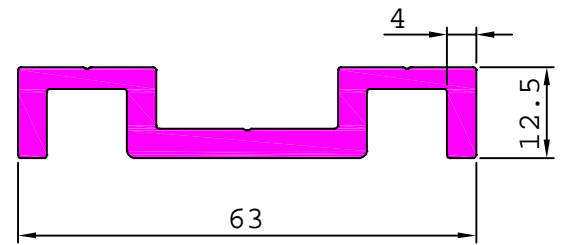

28647

5.329 kg/m

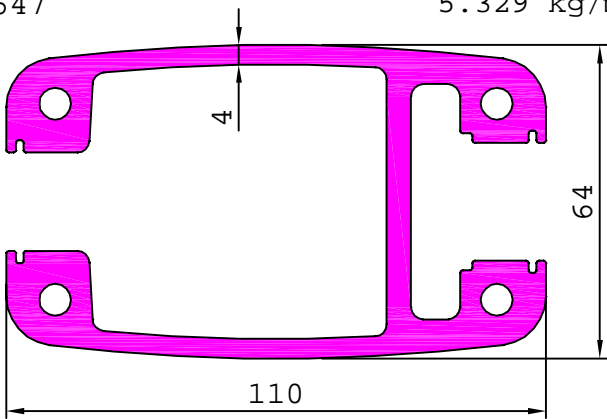

28648

5.654 kg/m

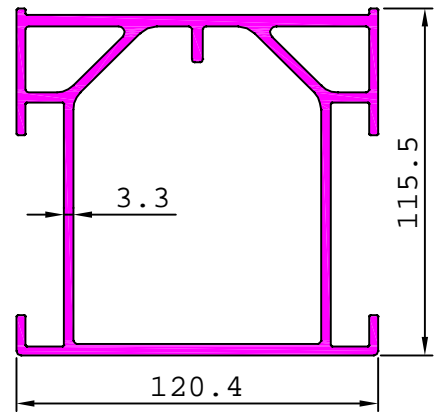

28649

12.173 kg/m

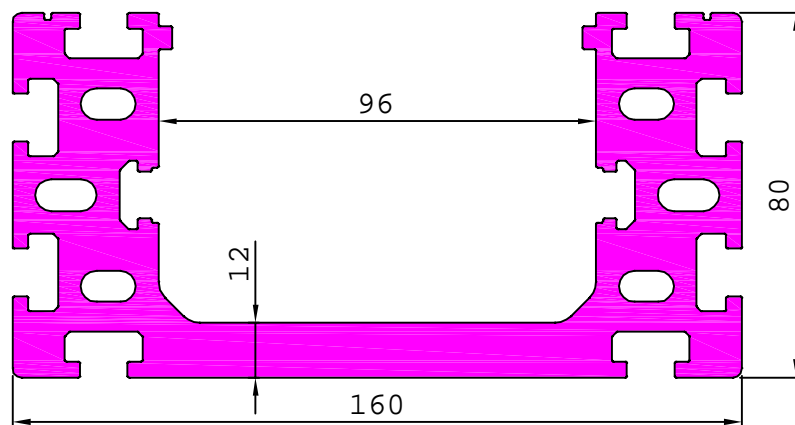

CONVEYOR SECTION

28651

1.575 kg/m

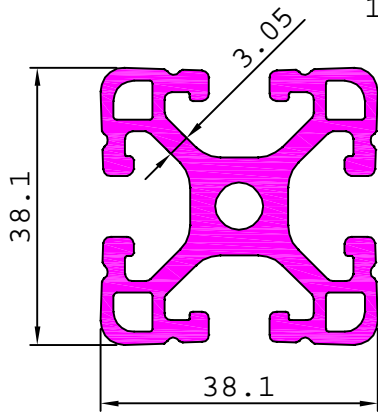

28656

6.205 kg/m

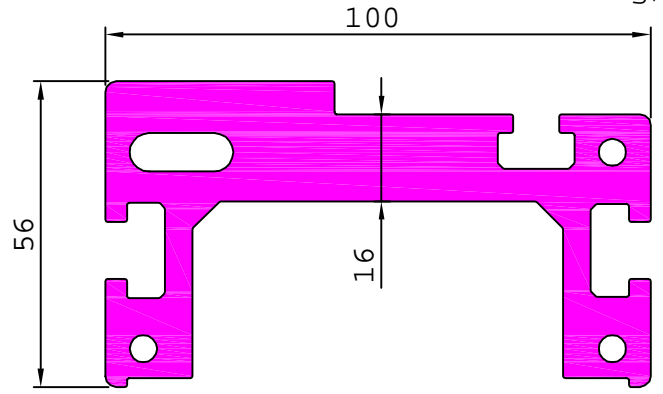

28644

7.972 kg/m

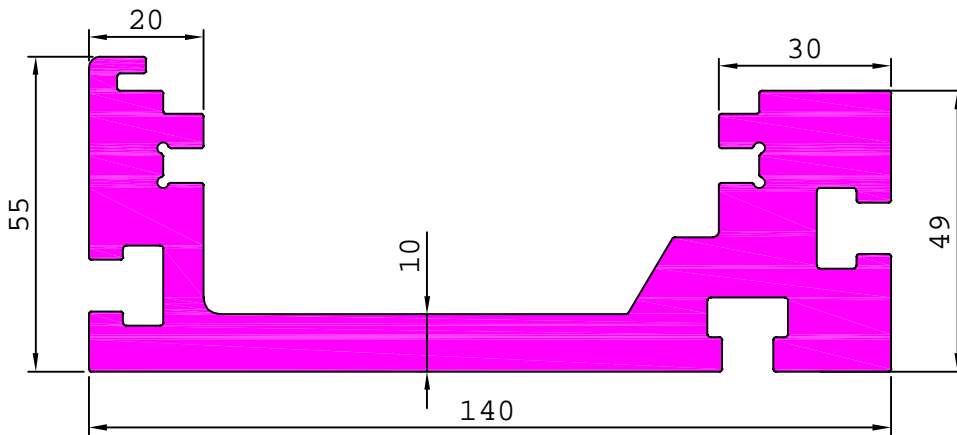

28657

4.883 kg/m

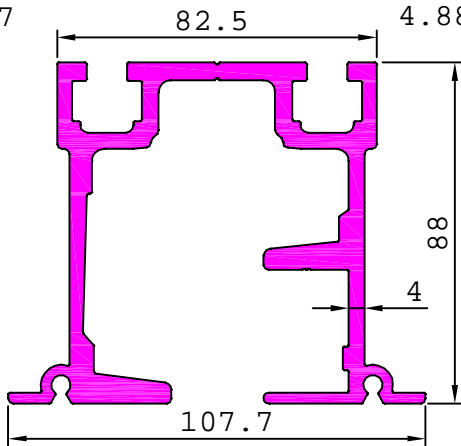

28646

0.421 kg/m

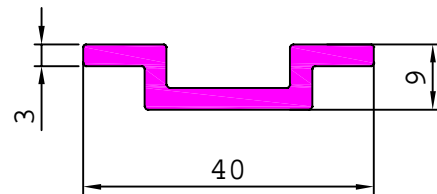

28663

4.661 kg/m

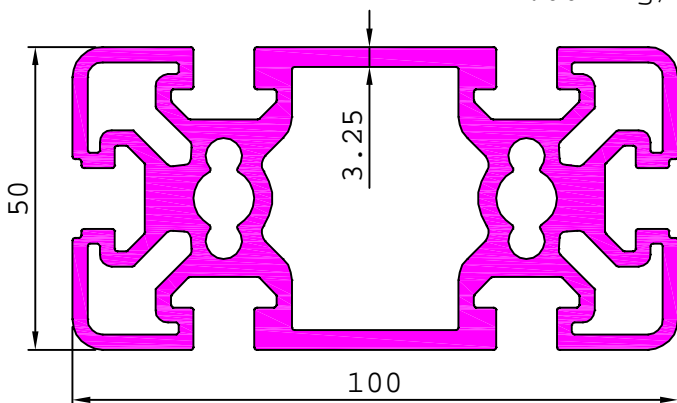

28664

1.889 kg/m

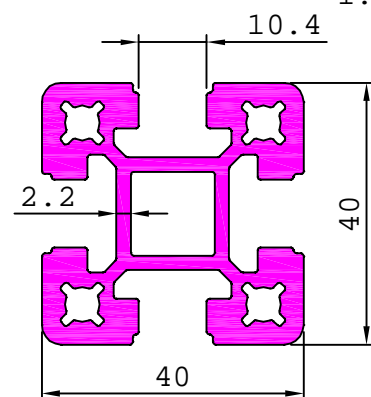

CONVEYOR SECTION

28665

10.009 kg/m

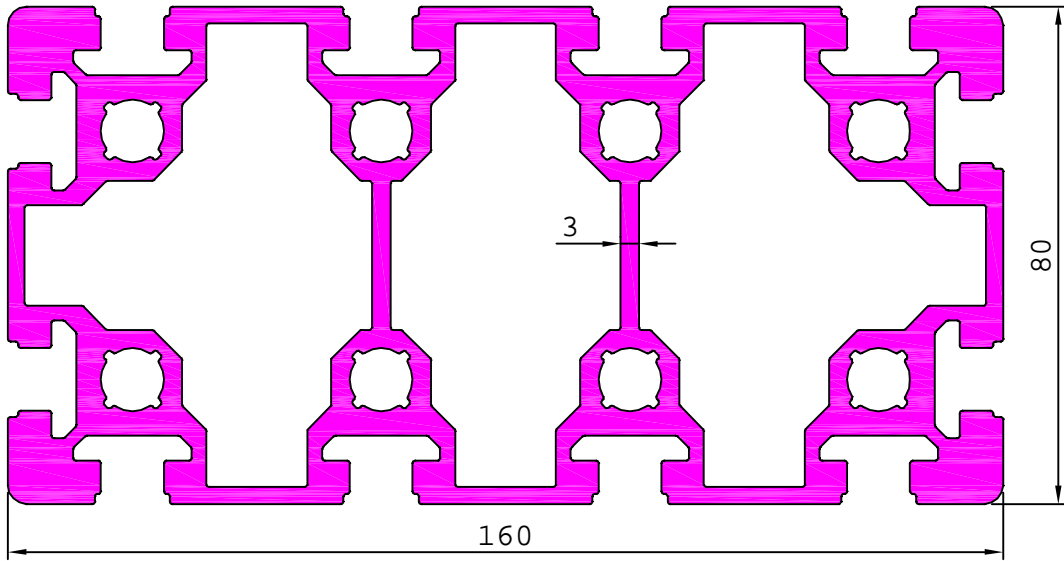

28667

13.329 kg/m

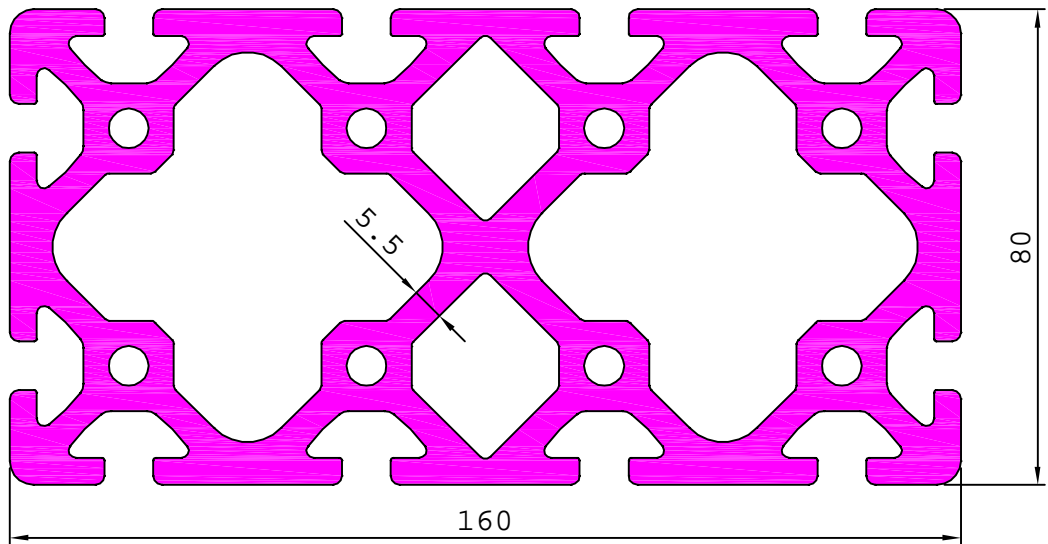

28653

5.775 kg/m

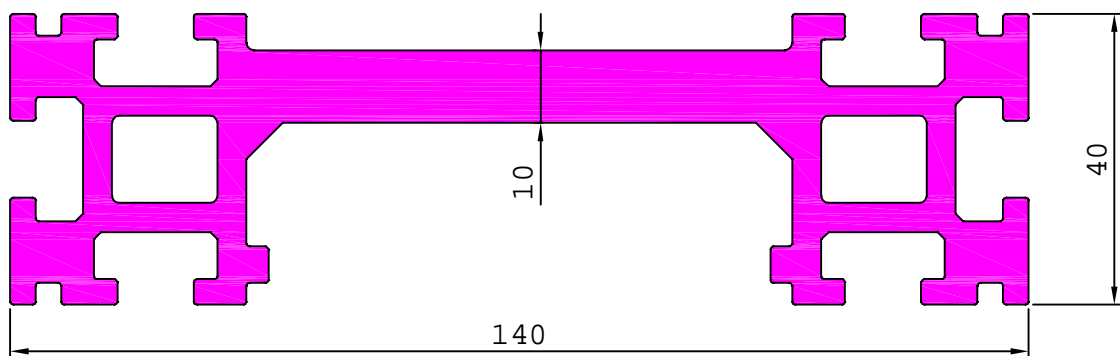

CONVEYOR SECTION

28666 1.398 kg/m

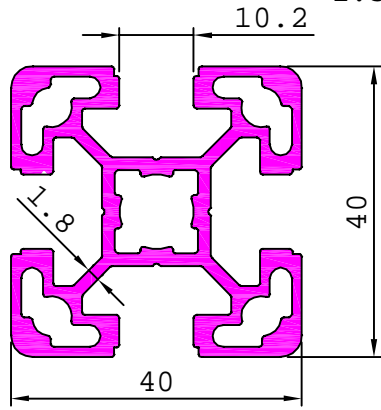

28668 3.903 kg/m

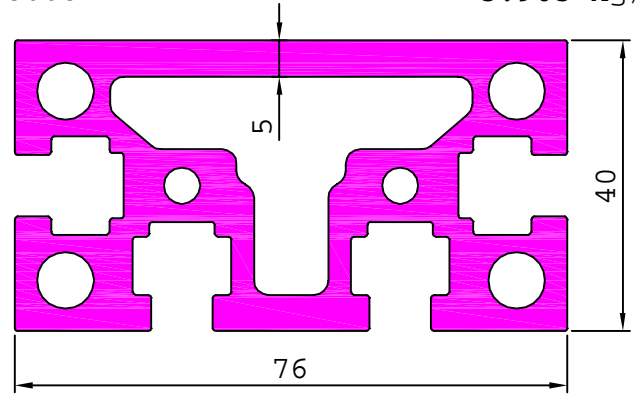

28672 2.905 kg/m

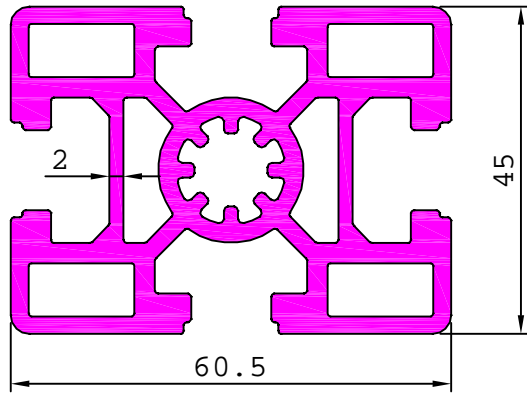

28673 0.427 kg/m

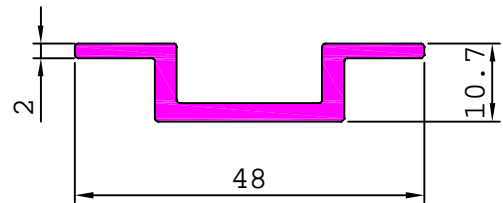

28675 1.692 kg/m

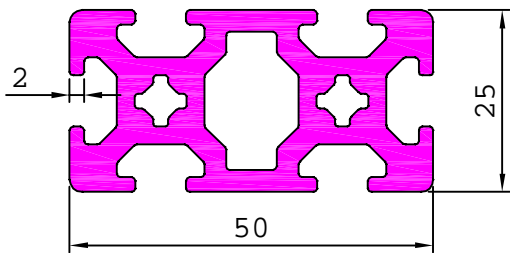

28778 1.818 kg/m

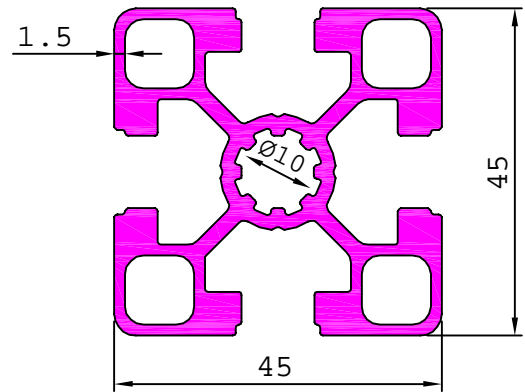

S4815 7.699 kg/m

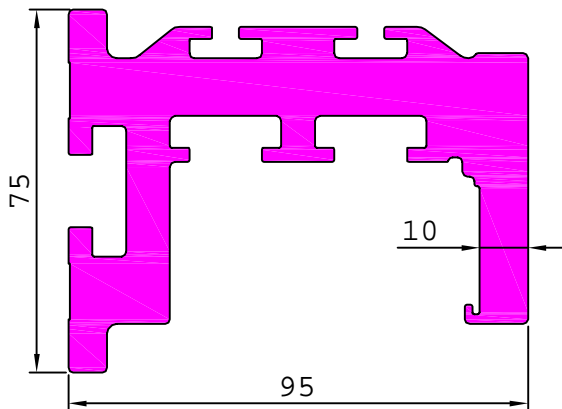

CONVEYOR SECTION

28677

2.606 kg/m

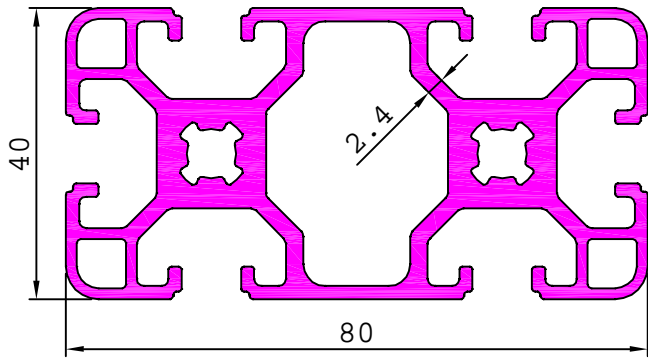

28681

2.484 kg/m

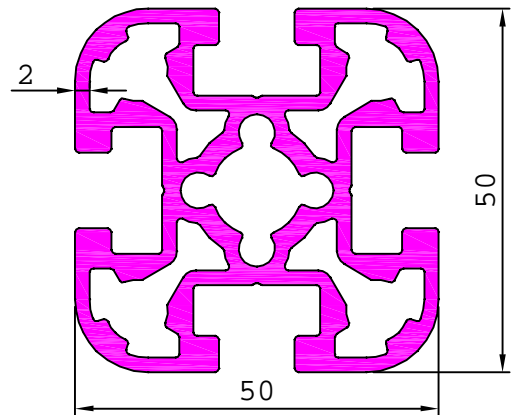

28683

1.635 kg/m

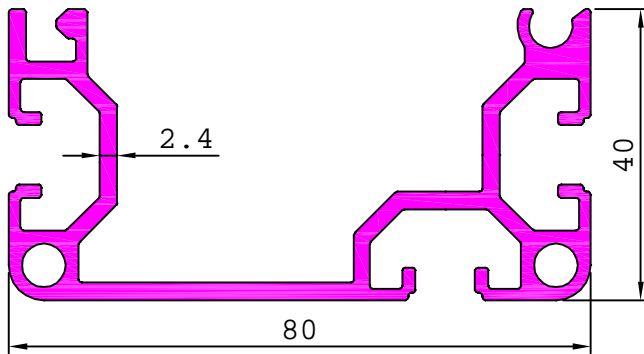

28432

9.257 kg/m

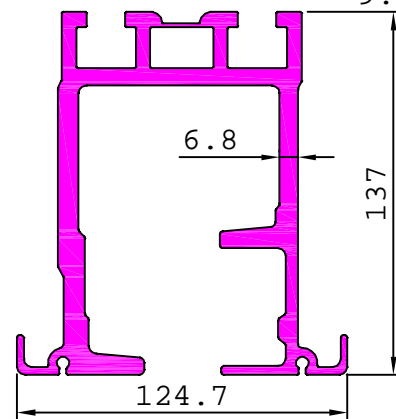

28685

0.853 kg/m

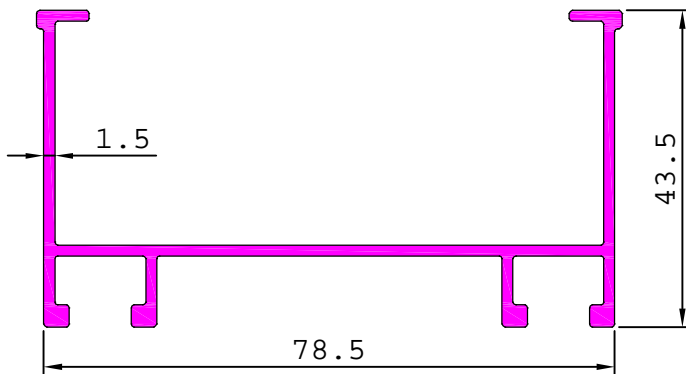

28936

8.473 kg/m

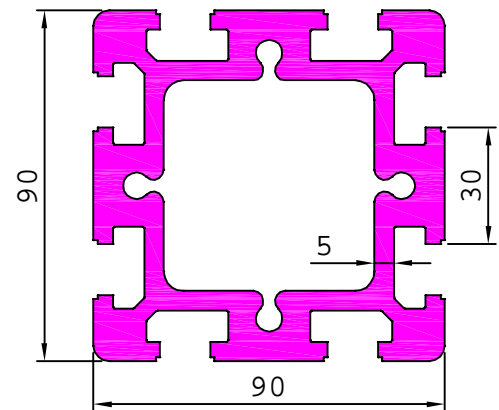

28686

155

3.717 kg/m

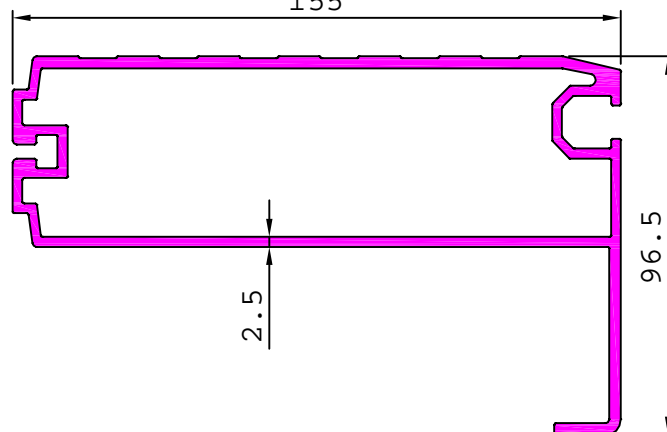

CONVEYOR SECTION

28679

6.021 kg/m

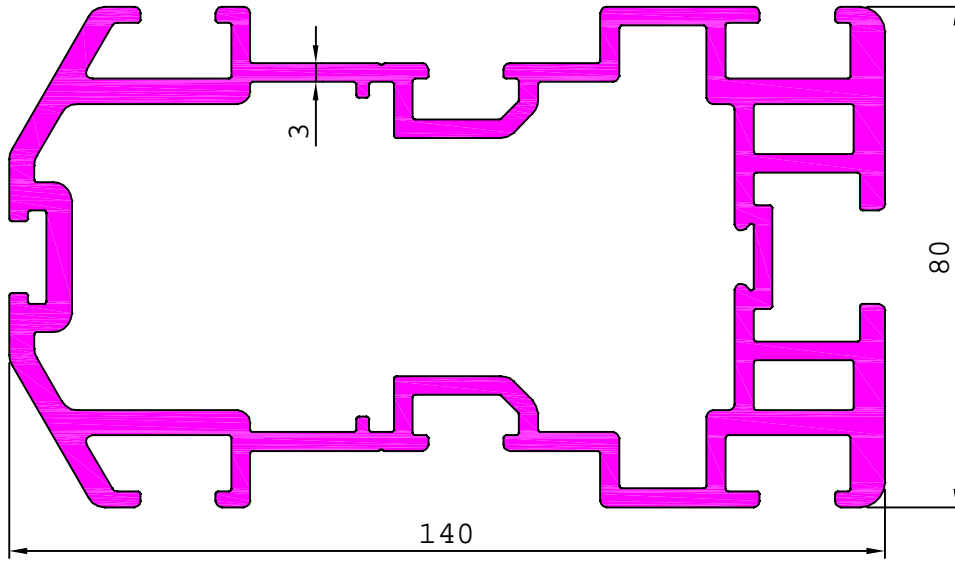

28682

25.585 kg/m

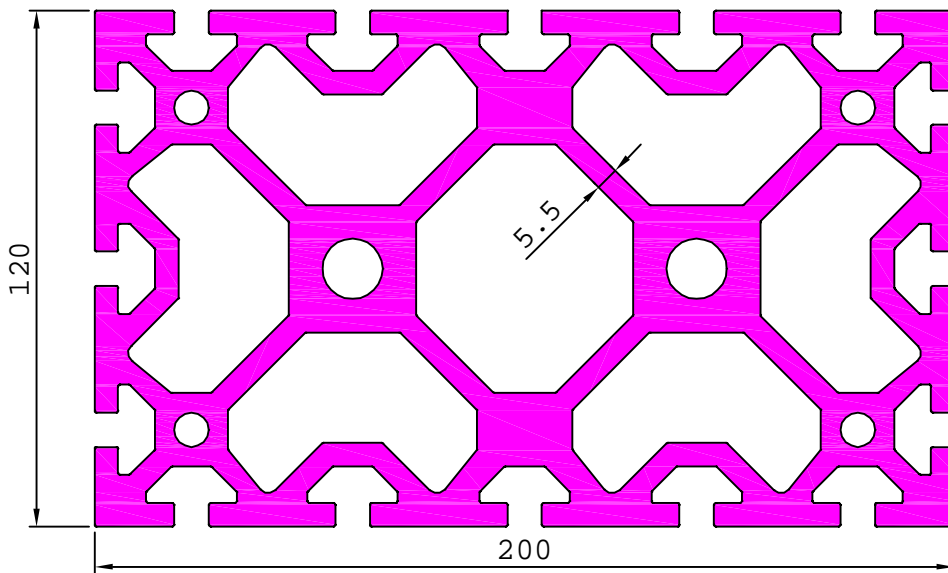

28521

10.825 kg/m

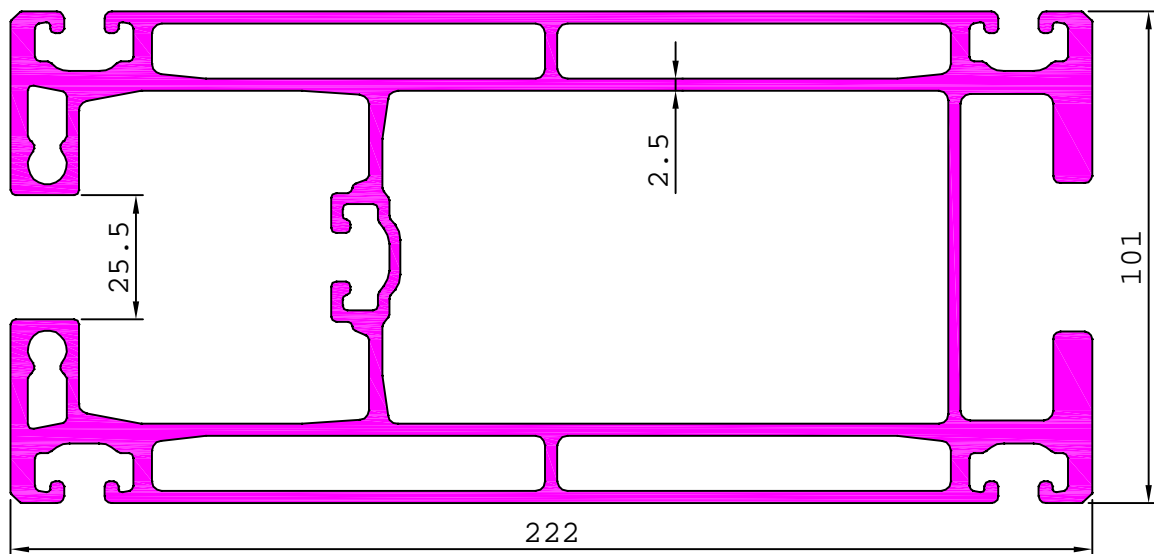

CONVEYOR SECTION

28481

6.772 kg/m

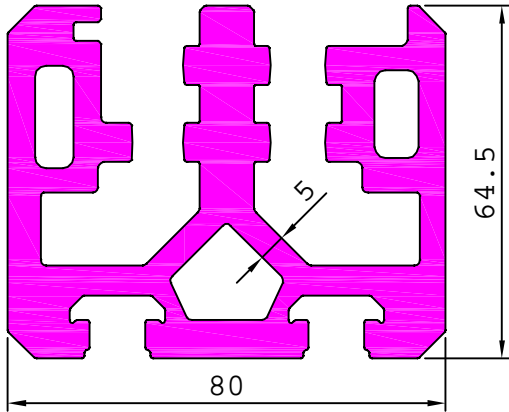

43508

5.073 kg/m

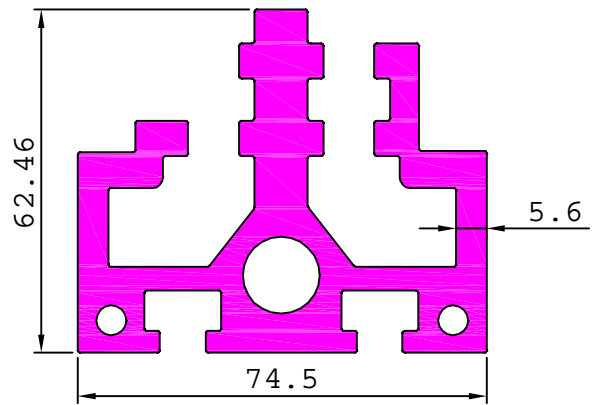

27808

7.106 kg/m

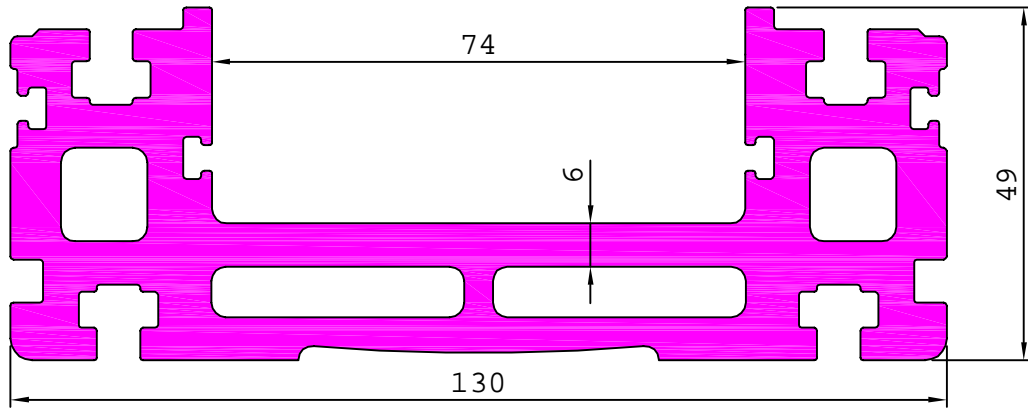

S6356

14.340 kg/m

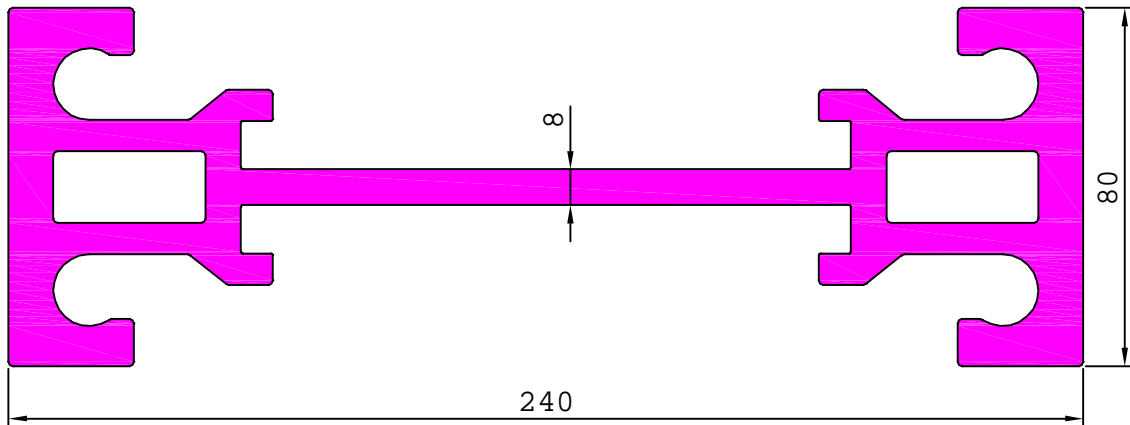

27859

3.686 kg/m

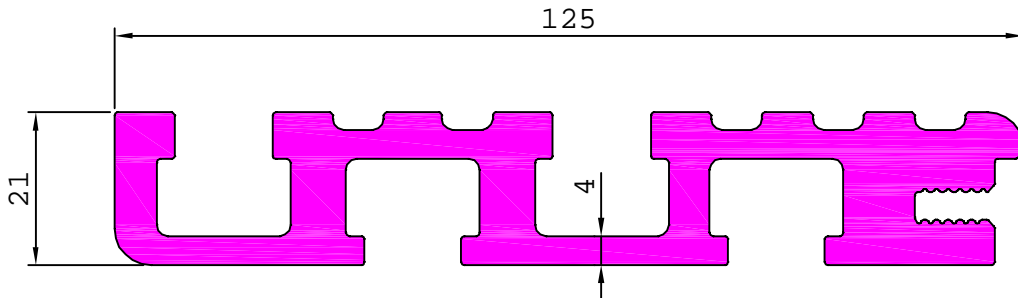

CONVEYOR SECTION

G101937

4.291 kg/m

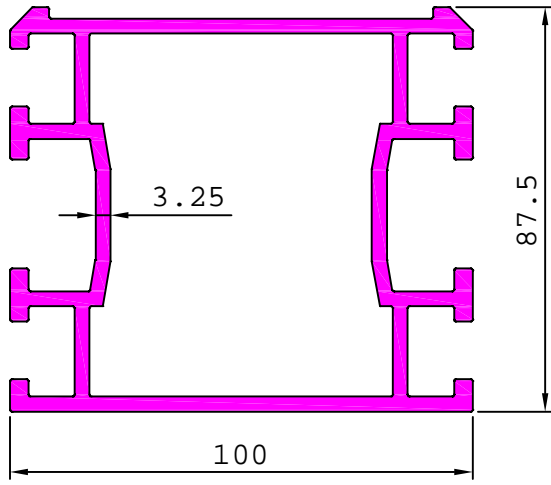

G101938

3.940 kg/m

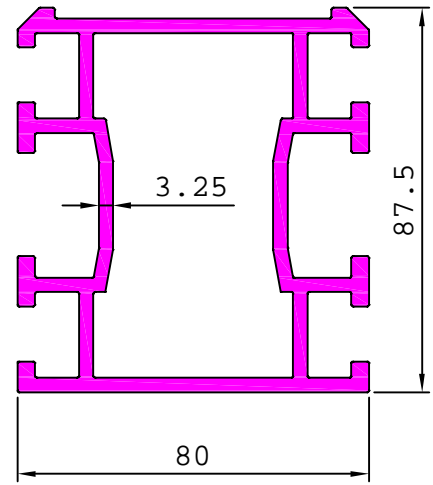

G101273

6.031 kg/m

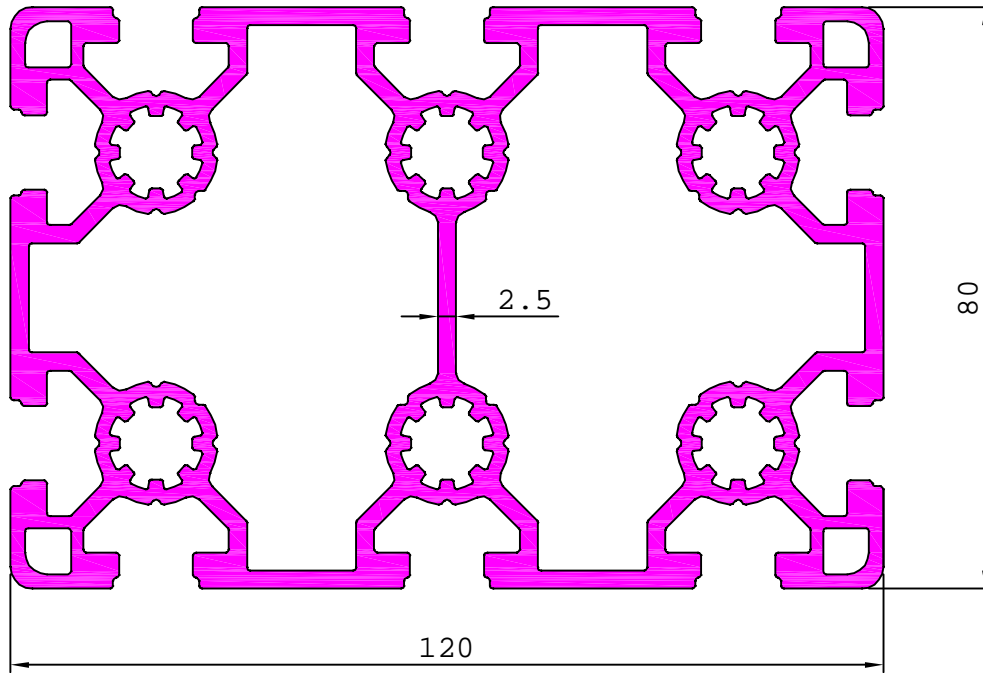

28687

0.269 kg/m

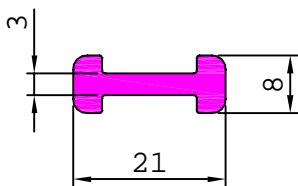

G102875

0.521 kg/m

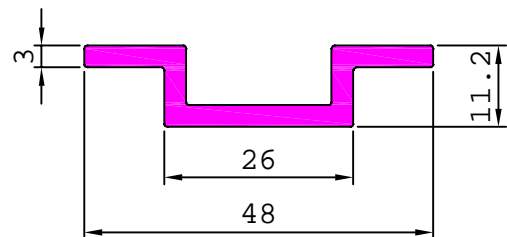

CONVEYOR SECTION

G102114

7.994 kg/m

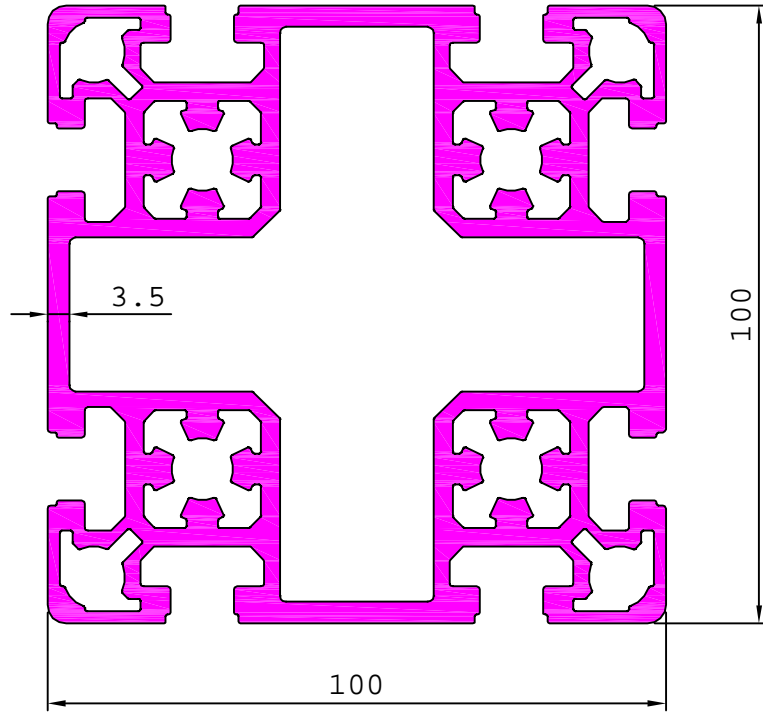

G103253

7.311 kg/m

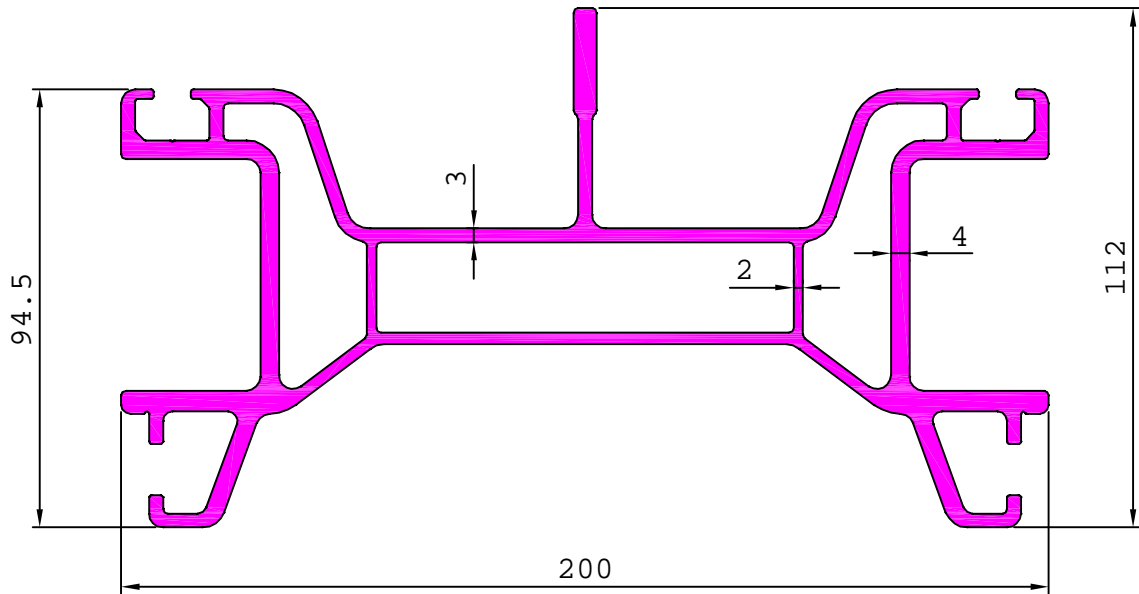

CONVEYOR SECTION

G103805

4.609 kg/m

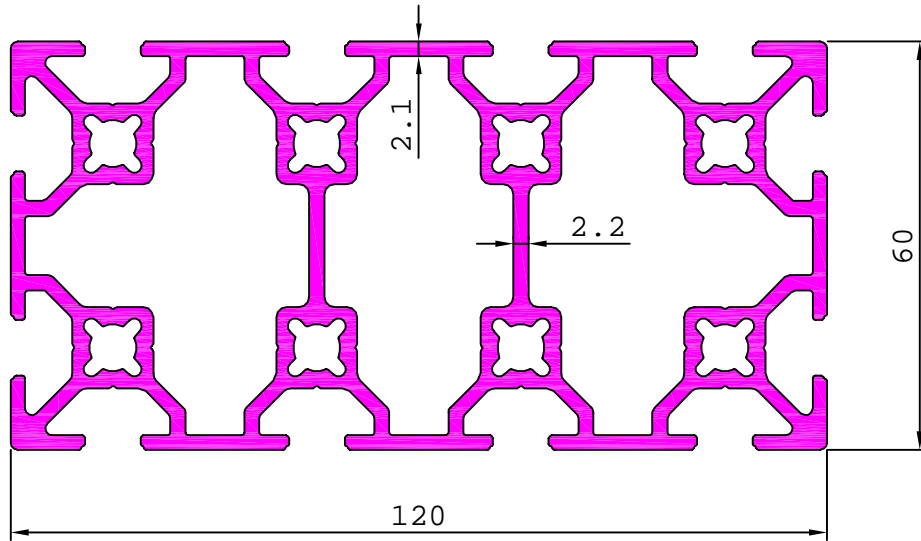

G103813

7.962 kg/m

